

YAMAHA

PROFESSIONAL SERIES

FREQUENCY DIVIDING NETWORK

F1040

OWNER'S MANUAL

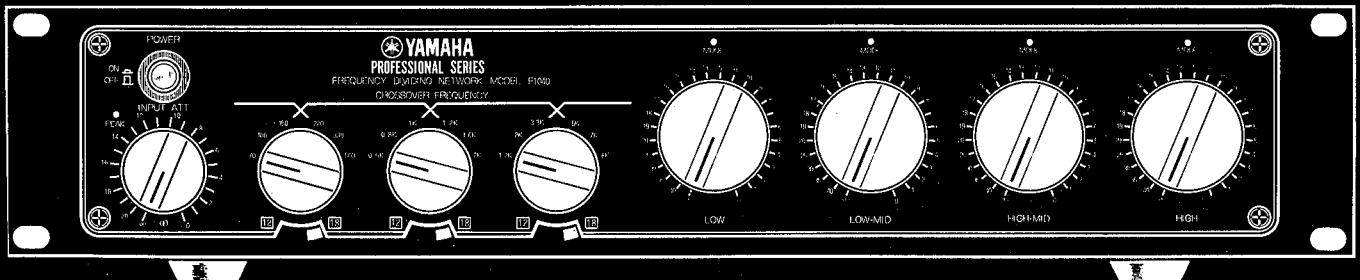

CONTENTS	
FEATURES/CAUTION	1
PANEL OPERATION	2
SETUP AND OPERATION	4
CONNECTION	6
CHARACTERISTICS FIGURES	7
INPUT/OUTPUT SPECIFICATIONS	7
OVERALL SPECIFICATIONS	8
BLOCK DIAGRAM	9

FEATURES / CAUTION

Thank you for purchasing a Yamaha F1040 Frequency Dividing Network.

The F1040 is a professional-grade four-way frequency dividing network that offers top-quality performance, features, reliability and durability. It is perfectly suited to a wide range of professional sound reinforcement and sound reproduction applications.

Please be sure to read this operation manual carefully in order to make the most of your F1040's extensive performance capabilities.

FEATURES

- All inputs and outputs feature Ground switches, balanced cannon connectors and standard phone jacks. All outputs feature Phase switches. Rack-mountable configuration. Rugged to withstand the rigors of professional use. Human-engineered layout for fast, error-free operation. Elegant Styling. Exceptionally high S/N ratio and low distortion.
- Four independent frequency ranges with individually selectable crossover frequencies offer ultimate multi-amp system capability. Permits higher power, more even frequency response, easier channel balancing, and cleaner overall sound.
- Input attenuator, peak indicator, mode selector (4-way, 3-way-1, 3-way-2, 2-way), mode indicators, independent crossover frequency selectors, rolloff slope selectors, and precise detent output level controls all add up to more convenient, more precise sound control.

IMPORTANT NOTICE FOR THE UNITED KINGDOM

Connecting the Plug and Cord

WARNING : THIS APPARATUS MUST BE EARTHED

IMPORTANT. The wires in this mains lead are coloured in accordance with the following code:

GREEN-AND-YELLOW	: EARTH
BLUE	: NEUTRAL
BROWN	: LIVE

As the colours of the wires in the mains lead of this apparatus may not correspond with the coloured markings identifying the terminals in your plug proceed as follows:

The wire which is coloured GREEN-AND-YELLOW must be connected to the terminal in the plug which is marked by the letter E or by the safety earth symbol \oplus or coloured GREEN or GREEN-AND-YELLOW.

The wire which is coloured BLUE must be connected to the terminal which is marked with the letter N or coloured BLACK.

The wire which is coloured BROWN must be connected to the terminal which is marked with the letter L or coloured RED.

CAUTION

- Locate the F1040 out of the direct rays of the sun, avoiding locations subject to vibration and excessive dust, heat, cold or moisture.
- Before transporting this unit, be sure to disconnect both the power supply cord and any other connecting cords to prevent their breakage or shorting.
- Do not attempt to clean any accumulations of dirt with chemical solvents (such as alcohol or benzene). Wipe only with a clean completely dry cloth.
- Keep this manual in a safe place for future reference, and refer to it frequently until you are fully familiar with your F1040.
- This model is designed to be mounted on 19" standard rack.
- Voltage Selector switch on the rear of the F1040 must be set for your local mains voltage **BEFORE** plugging in the AC main supply. Voltages are 110-120 or 220-240AC, 50/60Hz. U.S. and Canadian models are not provided with the voltage selector.

PANEL OPERATION

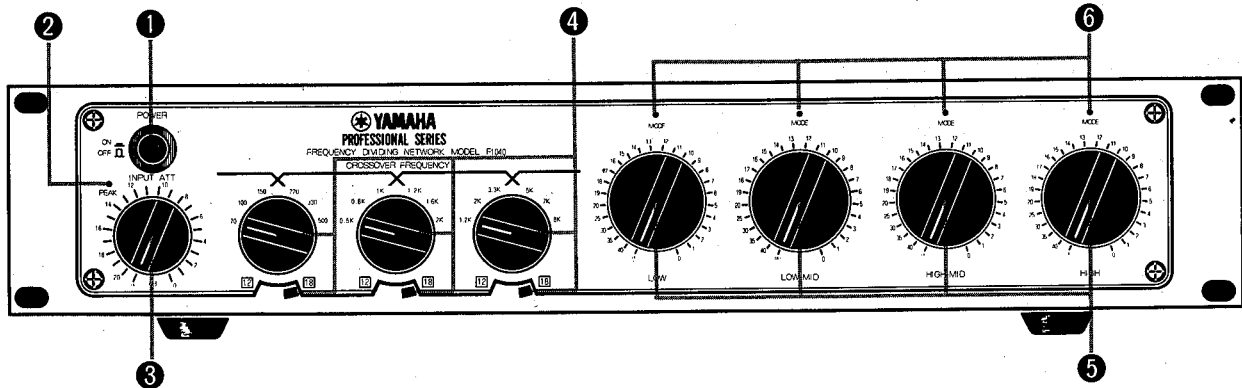

1 POWER Switch

Pressing this switch turns power to the unit ON. If this switch is pressed a second time, power is turned OFF.

* A built-in protective muting circuit is activated for 3 ~ 8 seconds after the unit is switched on, preventing damage to power amplifiers and speakers due to the initial power surge.

2 PEAK Indicator

This LED indicator lights instantly if input level exceeds +21 dB. If excessive input levels cause the peak indicator to light continuously care should be taken, and the input signal level should be reduced with the Input Attenuator.

3 INPUT Attenuator

This control is used to attenuate the input signal level to avoid overloading the input stage. Attenuation range is from 0 to -20 dB in 1 dB steps. A ∞ position is also provided in which input is turned off, and no sound can be heard.

This attenuator permits control of the input signal level which is independent of the output signal balance achieved by the output level controls.

4 CROSSOVER FREQUENCY Selectors

These selectors determine the crossover frequencies between the four frequency ranges to be divided. Six crossover frequencies can be selected by each of the three controls. Crossover is at -3 dB, and rolloff slopes of either 12 dB/oct or 18 dB/oct can be selected by switches below each crossover frequency selector.

5 Output Level Controls

Appreciate, detent output level control is provided for each of the four available frequency ranges. The output level of each range used is set with these controls to produce a flat response for the entire reproduction range.

6 MODE Indicators

LED indicators above each of the four output level controls indicate which frequency bands are in use. The mode indicators glow red to show which output level controls are functional as main system, and green for the controls which are

functional as sub-system. The diagram below shows how the LEDs are lit in each of the four operating modes, as selected by the mode selector switch on the back panel (see section 9 under "Panel Operation"). All indicators will glow red when the unit is operating in the 4 Way mode, while only the Low-Mid and High-Mid indicators will glow red and the Low and High indicators will glow green when the unit is operating in the 2 Way mode. Likewise, only the Low indicator will be green when in the 3 Way-1 mode, and only the High indicator will be green when in the 3 Way-2 mode. (See sections 2 and 3 under "Setup and Operation" for a complete description of the two "3 Way" modes).

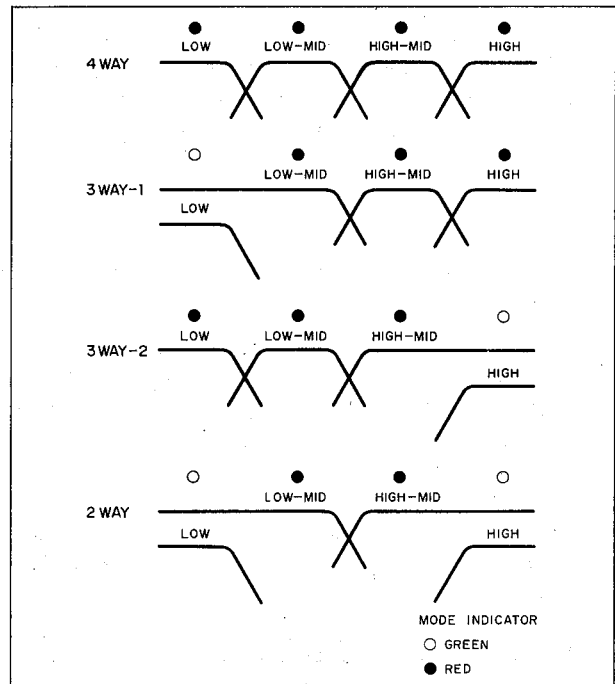

7 INPUT Connectors

The output from the mixer, preamp or other signal source is connected to this input. A cannon connector is provided for balanced, floating signal lines (Pin 1* shield or ground, Pin 2 "Hot", and Pin 3 "Cold") and a standard phone jack is provided.

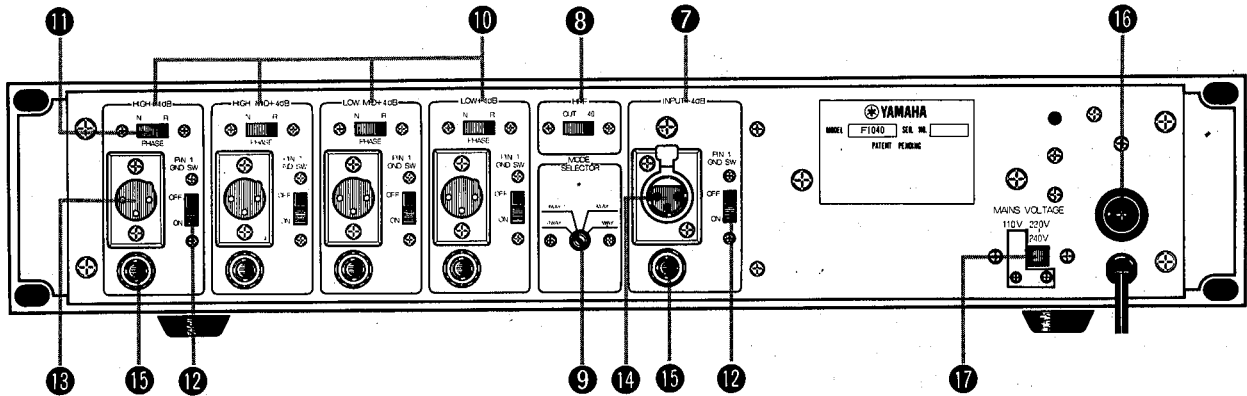

ed for unbalanced (two-wire) signal lines.

* If an input signal is connected to both the cannon connector and phone jack simultaneously, the phone jack takes priority.

8 HPF (High Pass Filter)

This switch activates a built-in high pass filter with a cutoff frequency of 40Hz and a rolloff of 12 dB/oct. When this filter is on (HPF switch at "40" position) signals below 40Hz are attenuated. This is useful for reducing "boominess" due to low-frequency standing-waves and resonance in the listening area.

9 MODE SELECTOR

This switch permits selection of four different frequency divider configurations: 4-way, 3-way-1, 3-way-2, or 2-way.

* 3-way-1 and 3-way-2 are both 3-way configurations, but with different crossover frequency selection ranges. (See sections 2 and 3 under "Setup and Operation".)

10 Output Connectors

The output from these connectors is fed to the power amplifiers which are to drive the respective speaker units. A cannon connector is provided for balanced (three-wire) signal lines, and a standard phone jack is provided for unbalanced (two-wire) signal lines.

Output impedance is 40 ohms for the Low and Low-Mid outputs, and 110 ohms for the Mid-High and High outputs.

* If the cannon connector and phone jack of any output are connected simultaneously, the phone jack takes priority.

11 Output PHASE Switches

An output phase switch is provided for each of the four outputs. The function of these switches is as follows: with the phase switch in the "N" position, a positive going voltage appearing on pin 2 at the input will also be positive going on pin 2 at any of the outputs. When using a floating or balanced input and an unbalanced output (phone jack), the phase switch has no effect: a positive

going voltage appearing on pin 2 at the input will induce a positive voltage at the tip of the phone jack output. However, in the case of either an unbalanced or balanced input, switching the phase switch to "R" will cause the positive going voltage to appear on pin 3 of the balanced output XLR connectors. This feature is useful for insuring equal phase relationships despite phase reversals caused by the use of cables and/or other audio equipment wired for pin 3 Hot (rather than pin 2).

12 PIN 1 GND SW

These switches are used to couple or decouple the ground (shield) pin of the balanced input and output cannon connectors. Inductive hum pickup by the sound equipment can often be eliminated by decoupling the ground line on the affected channel.

13 XLR-3-32 Cannon Connectors

The pin configuration for these connectors is: Pin 1 = shield or ground, Pin 2 = Hot, and Pin 3 = Cold. Appropriate plugs for these connectors are the Cannon XLR-3-11C or Switchcraft 5C-1056A (formerly A-3-F).

14 XLR-3-31 Cannon Connectors

Appropriate plugs for these connectors are the Cannon XLR-3-12C or Switchcraft 5C-1055A (formerly A-3-M).

15 Phone Jacks

All phone jacks used are standard 1/4" types, with the "+" or "high" signal present at the tip of the connector.

16 Fuse

Always use a fuse with the same ratings of the existing one for replacement purposes.

17 VOLTAGE SELECTOR (General Models Only)

Set this to your local AC mains voltage. Failure to do so will result in seriously impaired performance or even severe damage.

SETUP AND OPERATION

In a multi-amp sound reinforcement system, the individual speakers for each frequency range can be driven at much higher power than is possible with conventional LC crossover networks. It is also possible to obtain a much flatter overall frequency response than attainable with LC networks. Multi-amp systems permit the sound engineer to make full use of the individual characteristics of each driver. Other advantages include easier balancing between channels, and the capability to set up a system that is highly resistant to acoustic feedback by carefully taking into account the directional characteristics of the high-mid and high frequency drivers.

1. 4-Way Operation

Set the Mode Selector on the rear panel to "4 Way" and select the desired crossover frequencies with Crossover Frequency selectors A, B and C. The reproduction range of the speakers used must be taken into account when setting crossover frequencies. With a four-way speaker setup including a super-tweeter for the High range it is possible to obtain an exceptionally clear sound field over an extensive reproduction frequency range.

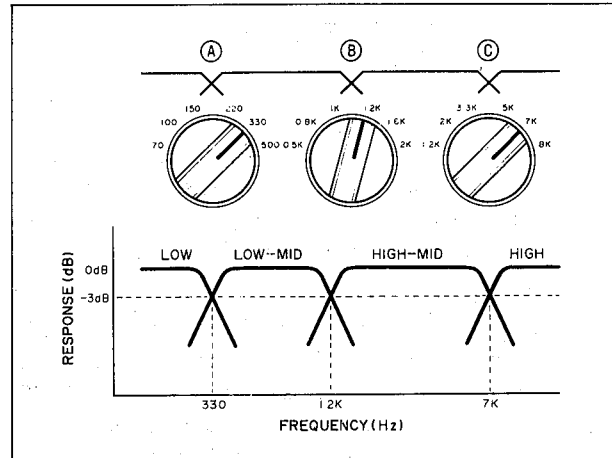

2. 3-Way-1 Operation

Set the rear-panel Mode selector to "3 Way-1" and select the desired crossover frequencies with Crossover Frequency selectors B and C. Use the Low-Mid, High-Mid and High outputs and level controls. This configuration forms a tri-amp system with emphasis on the high frequency ranges. If higher bass output is required, a super woofer can be added, overlapping the lower range limit of the standard woofer. The super-woofer high-end cutoff frequency can be set using Crossover Frequency selector A.

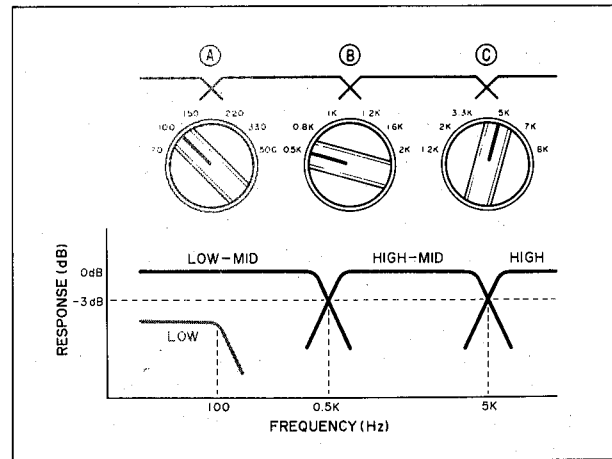

3. 3-Way-2 Operation

Set the rear-panel Mode selector to "3 Way-2" and select the desired crossover frequencies with Crossover Frequency selectors A and B. Use the Low, Low-Mid and High-Mid outputs and level controls. This configuration forms a tri-amp system with emphasis on the low frequency ranges. In a system using mid-bass drivers, it is particularly effective to set the bass/mid-bass crossover frequency below 500Hz---a frequency difficult to obtain with LC crossover networks. It is also possible to add a super-tweeter to this configuration using the High output. The low-end cutoff frequency of the super-tweeter can be set using Crossover Frequency selector C.

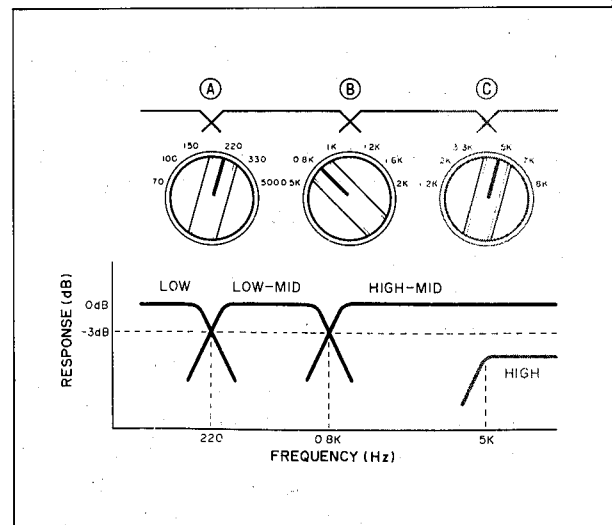

4. 2-Way Operation

Set the rear-panel Mode selector to "2 Way" and select the desired crossover frequency with Crossover Frequency selector B.

Use the Low-Mid and High-Mid outputs and level controls.

As with the 3-way-1 and 3-way-2 configurations, it is possible to add extra speakers overlapping the high and low range speakers using the High and Low outputs.

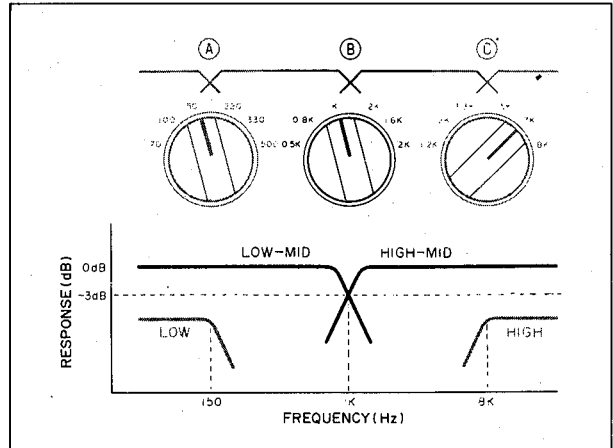

●Setting Crossover Frequencies

Crossover frequencies should be set to the values recommended for the particular speakers used. Driving a speaker with frequencies below its rated reproduction range may result in damage to the voice coil. Take particular care when setting the crossover frequency for high frequency drivers.

●Setting Crossover Rolloff Slope

The rolloff slope at the crossover frequencies for each range can be set at 12 dB/oct or 18 dB/oct with switches provided. The 18 dB/oct setting provides extremely sharp rolloff at the crossover frequencies producing an exceptionally well-defined sound that is most appropriate for large halls with relatively long reverberation times. In actual use, however, the choice of rolloff slopes depends on many factors including the transmission characteristics of the room and sound system. The best settings are most effectively determined by ear.

●System Phasing

Depending on the rolloff slope settings for each frequency range, cases may arise where the phases of the output signals at the crossover frequencies do not match properly resulting in unnatural sound reproduction. The system should be adjusted for minimum phase variation by rearranging the positions of the speakers or by using the output phase switches.

Mounting the security cover

When utilizing the F1040 in a fixed sound reinforcement installation, it is often desirable to set the crossover frequencies, input attenuator, and output level controls in a permanent configuration. To avoid the inconvenience of having the controls mistakenly or carelessly readjusted, mount the security cover as follows.

Setscrews

Setscrews

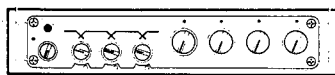

(1) Remove the setscrews of the front panel.

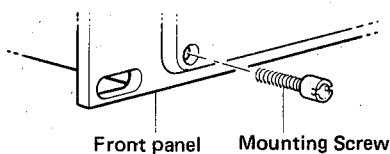

(2) Mount the accessory cover mounting screws in place of the front panel's setscrews.

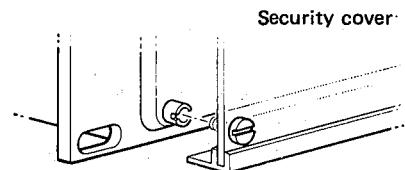

(3) Mount the security cover in line with the mounting screws.

CONNECTION

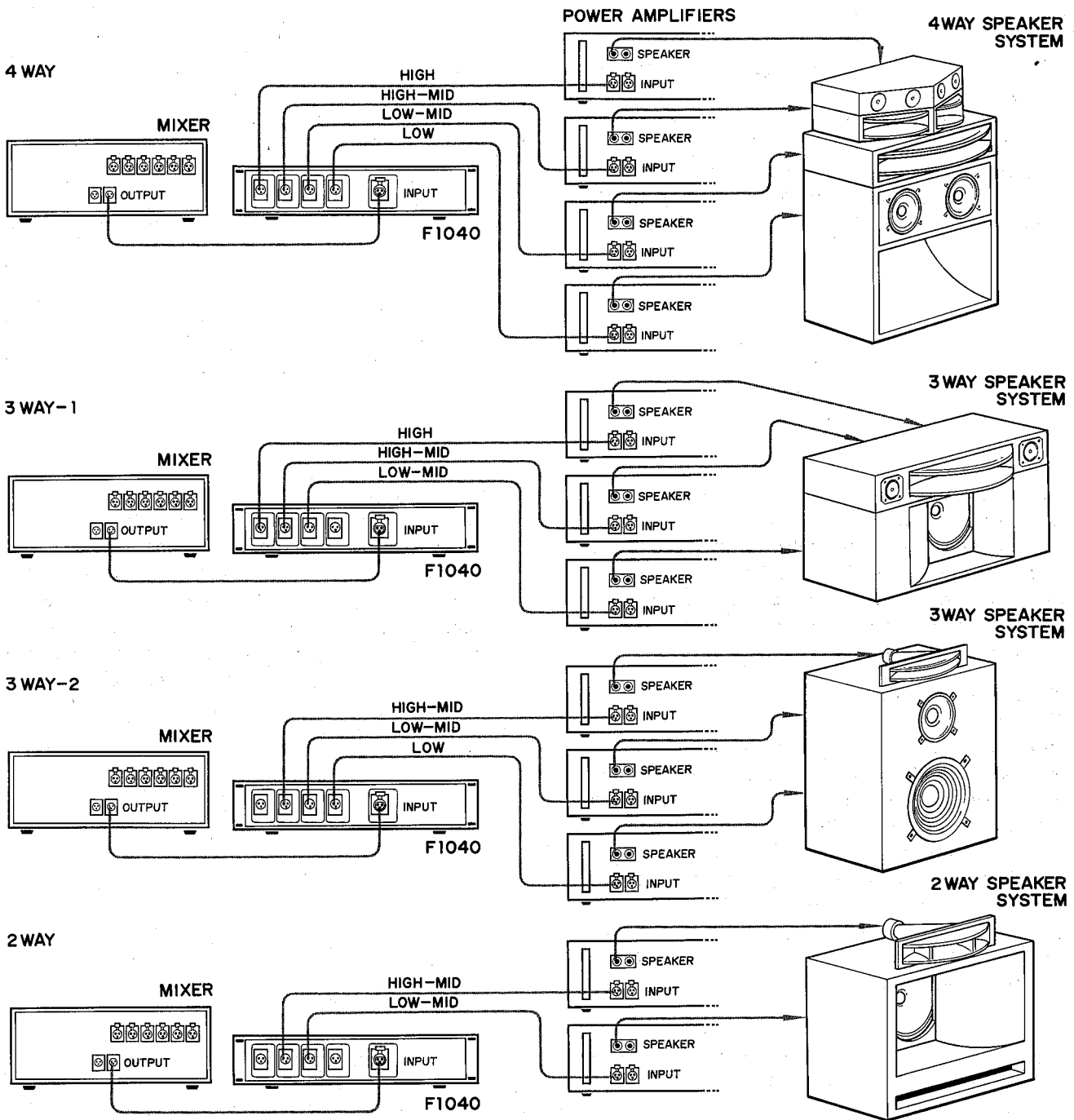

●Speaker Connection

When connecting speakers, care should be taken to properly match the impedance of the speakers for each frequency range to the output impedances of their respective power amplifiers. The crossover frequency for each frequency range should be carefully selected in accordance with the reproduction range of the speakers used.

●Power Amplifier Connection

In general, the maximum permissible power input for high frequency driver units is relatively small compared to low and mid frequency drivers. The output level of the high range power amplifier should be carefully set in accordance with the maximum permissible input of the high frequency driver used.

When connecting or disconnecting speaker cables, be sure that the related power amplifiers are turned off.

CHARACTERISTICS FIGURES / INPUT, OUTPUT SPECIFICATIONS

FREQUENCY RESPONSE (18 dB/oct)

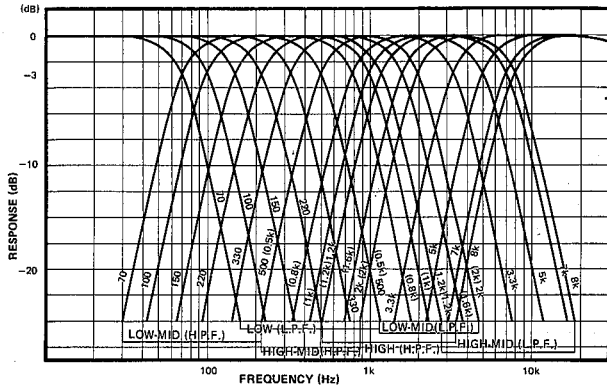

FREQUENCY RESPONSE (12 dB/oct)

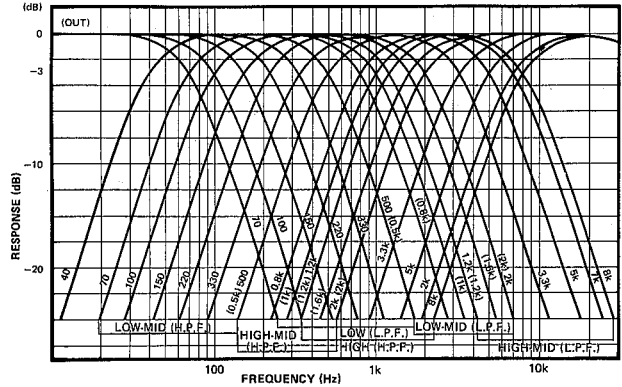

FREQUENCY RESPONSE VS T.H.D.

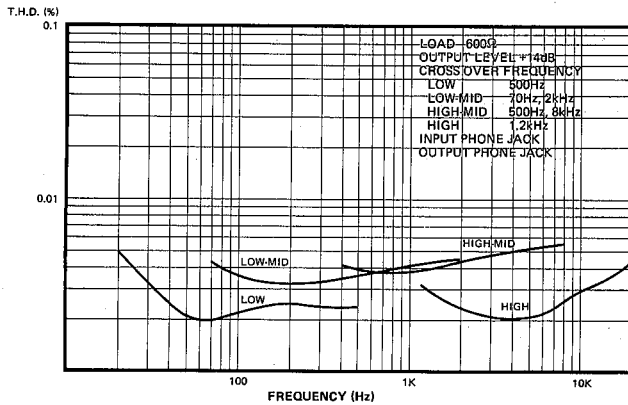

TOTAL HARMONIC DISTORTION

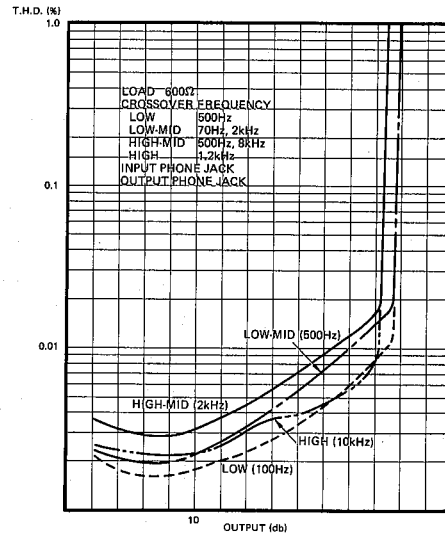

INPUT, OUTPUT SPECIFICATIONS

CONNECTION	INPUT IMPEDANCE	SOURCE IMPEDANCE	INPUT LEVEL		CONNECTOR
			NOMINAL	MAX. before clip	
INPUT	10kΩ	600Ω	+4 dB (1.23V)	+24 dB (12.3V)	XLR-3-31 PHONE JACK

CONNECTION	OUTPUT IMPEDANCE	LOAD IMPEDANCE	OUTPUT LEVEL		CONNECTOR
			NOMINAL	MAX. before clip	
OUTPUT					
LOW	40Ω	600Ω	+4 dB (1.23V)	+24 dB (12.3V)	XLR-3-32 PHONE JACK
LOW-MID	40Ω				
HIGH-MID	110Ω				
HIGH	110Ω				

- 0 dB is referenced to 0.775 V r.m.s.
- All XLR connectors are floating and transformer-isolated; phone jacks are unbalanced. Phone jacks have preference to XLR.

OVERALL SPECIFICATIONS

FREQUENCY RESPONSE		
LOW OUTPUT	0 ± 0.5 dB	20Hz
HIGH OUTPUT	0 $\begin{smallmatrix} +0.5 \\ -1 \end{smallmatrix}$ dB	20kHz
TOTAL HARMONIC DISTORTION		
XLR	Less than 0.2%	+14dB, 20Hz ~ 20kHz
PHONE JACK	Less than 0.01%	+14dB, 20Hz ~ 20kHz
*HUM & NOISE	-100dB	INPUT 150Ω shorted INPUT & OUTPUT ATT : max LOW OUTPUT Crossover Frequency 500Hz LOW-MID OUTPUT Crossover Frequency 70Hz, 2kHz HIGH-MID OUTPUT Crossover Frequency 0.5kHz, 8kHz HIGH OUTPUT Crossover Frequency 1.2kHz
MAXIMUM VOLTAGE GAIN	0 dB	
CONTROLS		
INPUT ATT	1 dB Step (0 ~ 20), 22 position	
OUTPUT LEVEL CONTROLS	LOW, LOW-MID, HIGH-MID, HIGH 1 dB Step (0 ~ 20), 26 position	
CROSSOVER FREQUENCY	Low : 70, 100, 150, 220, 330, 500Hz Mid : 0.5k, 0.8k, 1k, 1.2k, 1.6k, 2kHz High : 1.2k, 2k, 3.3k, 5k, 7k, 8kHz	
SLOPE SELECTOR	Low : 12dB/oct, 18dB/oct Mid : 12dB/oct, 18dB/oct High : 12dB/oct, 18dB/oct	
MODE SELECTOR	4 WAY, 3 WAY-1, 3 WAY-2, 2 WAY	
HIGH PASS FILTER	40Hz, 12dB/oct	
OUTPUT PHASE	LOW, LOW-MID, HIGH-MID, HIGH NORMAL/REVERSE	
PIN 1 GND SW	INPUT, LOW, LOW-MID, HIGH-MID, HIGH	
INDICATORS		
PEAK INDICATOR	LED is turned on at 3dB below Clipping	
MODE INDICATOR	2 color LED's (green/red)	
POWER SOURCE	U.S. & Canadian Models 120V AC60Hz General Models 110-120 or 220-240 AC selectable, 50/60Hz	
POWER CONSUMPTION	U.S. Model 25W Canadian Model 25VA General Models 25W	
DIMENSIONS (W x D x H)	480 x 304.7 x 95.5 mm (18-7/8 x 12 x 3-3/4") When security cover mounted: 480 x 317.7 x 95.5 mm (18-7/8 x 12-1/2 x 3-3/4")	
WEIGHT	8 kg (17.6 lbs)	

* Measured with -6dB/oct filter @ 12.47kHz equivalent to a 20kHz filter with infinite dB/oct attenuation.

● 0 dB is referenced to 0.775V r.m.s.

Specification subject to change without notice.

BLOCK DIAGRAM

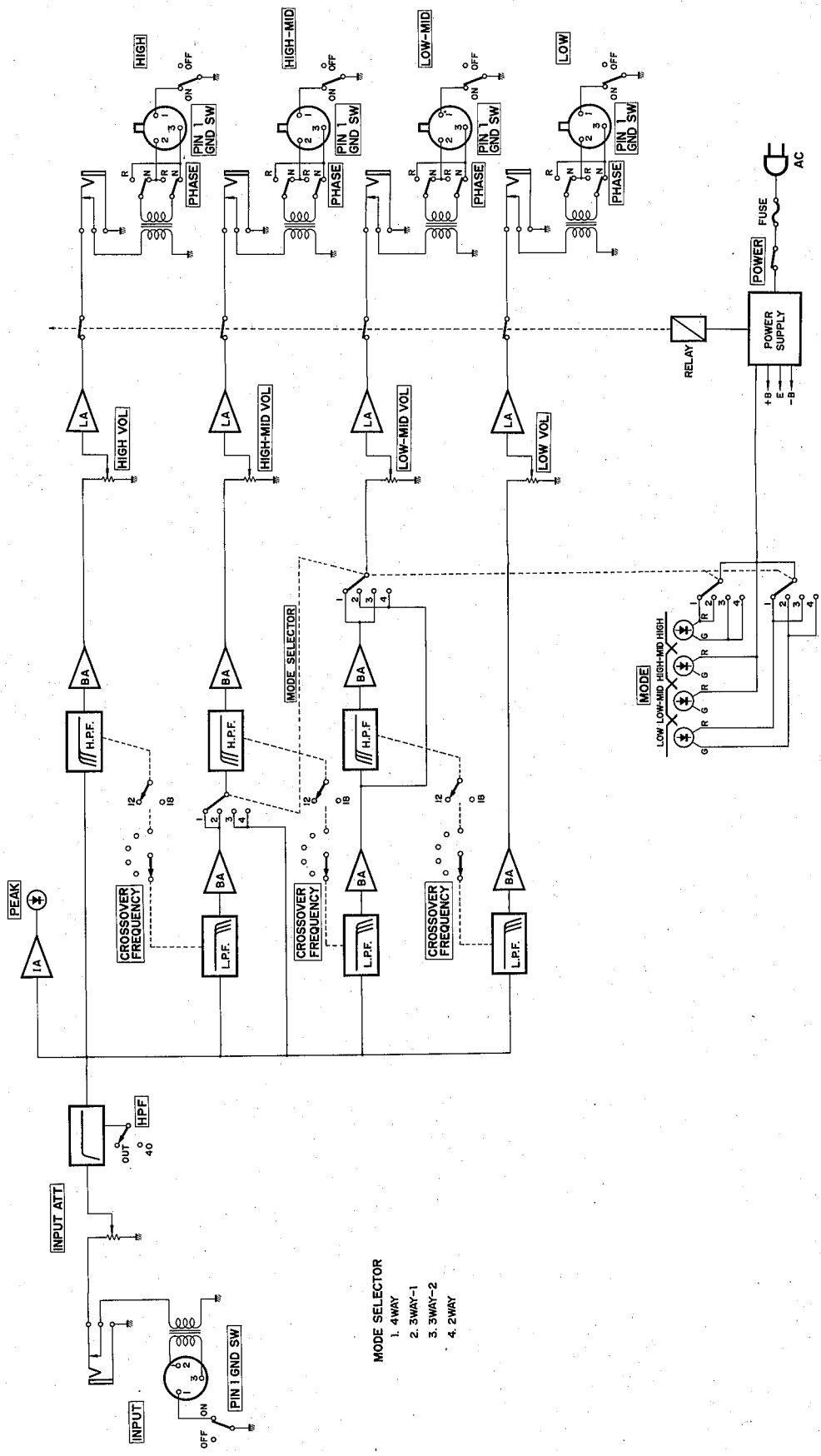

YAMAHA

8