

disklavier™ *E3*

Operation manual
Manuel de l'utilisateur



SPECIAL MESSAGE SECTION

PRODUCT SAFETY MARKINGS: Yamaha electronic products may have either labels similar to the graphics shown below or molded/stamped facsimiles of these graphics on the enclosure. The explanation of these graphics appears on this page. Please observe all cautions indicated on this page and those indicated on the safety instruction section.

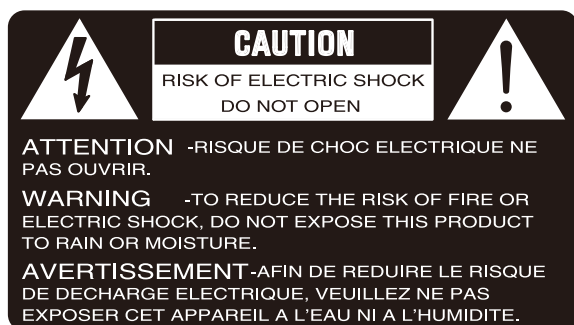

SEE BOTTOM OF ENCLOSURE OR LOWER FRONT PANEL FOR GRAPHIC SYMBOL MARKINGS



The exclamation point within the equilateral triangle is intended to alert the user to the presence of important operating and maintenance (servicing) instructions in the literature accompanying the product.

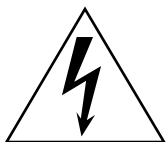

The lightning flash with arrowhead symbol within the equilateral triangle is intended to alert the user to the presence of uninsulated “dangerous voltage” within the product’s enclosure that may be of sufficient magnitude to constitute a risk of electrical shock.

IMPORTANT NOTICE: All Yamaha electronic products are tested and approved by an independent safety testing laboratory in order that you may be sure that when it is properly installed and used in its normal and customary manner, all foreseeable risks have been eliminated. DO NOT modify this unit or commission others to do so unless specifically authorized by Yamaha. Product performance and/or safety standards may be diminished. Claims filed under the expressed warranty may be denied if the unit is/has been modified. Implied warranties may also be affected.

SPECIFICATIONS SUBJECT TO CHANGE: The information contained in this manual is believed to be correct at the time of printing. However, Yamaha reserves the right to change or modify any of the specifications without notice or obligation to update existing units.

ENVIRONMENTAL ISSUES: Yamaha strives to produce products that are both user safe and environmentally friendly. We sincerely believe that our products and the production methods used to produce them, meet these goals. In keeping with both the letter and the spirit of the law, we want you to be aware of the following:

Battery Notice: This product MAY contain a small non-rechargeable battery which (if applicable) is soldered in place. The average life span of this type of battery is approximately five years. When replacement becomes necessary, contact a qualified service representative to perform the replacement.

Warning: Do not attempt to recharge, disassemble, or incinerate this type of battery. Keep all batteries away from children. Dispose of used batteries promptly and as regulated by applicable laws. Note: In some areas, the servicer is required by law to return the defective parts. However, you do have the option of having the servicer dispose of these parts for you.

Disposal Notice: Should this product become damaged beyond repair, or for some reason its useful life is considered to be at an end, please observe all local, state, and federal regulations that relate to the disposal of products that contain lead, batteries, plastics, etc.

NOTICE: Service charges incurred due to lack of knowledge relating to how a function or effect works (when the unit is operating as designed) are not covered by the manufacturer’s warranty, and are therefore the owners responsibility. Please study this manual carefully and consult your dealer before requesting service.

NAME PLATE LOCATION: The graphic below indicates the location of the name plate. The model number, serial number, power requirements, etc., are located on this plate. You should record the model number, serial number, and the date of purchase in the spaces provided below and retain this manual as a permanent record of your purchase.

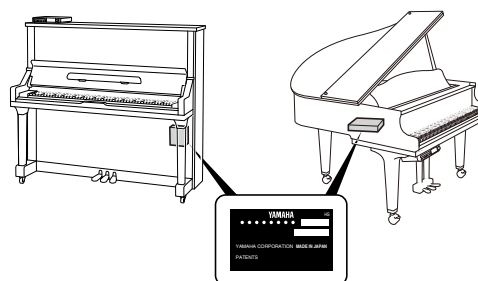

Model _____

Serial No. _____

Purchase Date _____

SECTION DE MESSAGE SPÉCIAL

INSCRIPTIONS DE SÉCURITÉ DU PRODUIT: Les produits électroniques Yamaha peuvent comporter des étiquettes semblables aux représentations graphiques indiquées ci-dessous ou fac-similés moulés/estampés de ces représentations graphiques sur l'encoffrement. L'explication de ces représentations graphiques apparaît à cette page. Veuillez respecter toutes les précautions indiquées à cette page et celles indiquées dans la section des directives de sécurité.

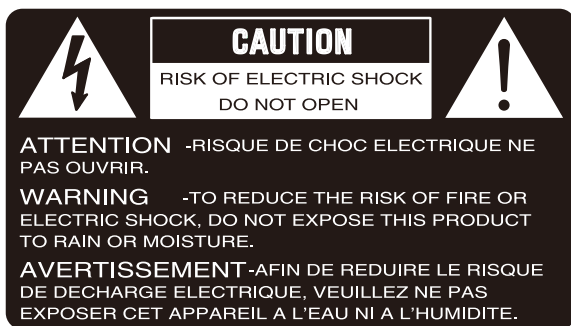

VOIR SOUS L'ENCOFFREMENT OU EN BAS DU PANNEAU FRONTAL EN CE QUI CONCERNE LES INSCRIPTIONS DE SYMBOLE GRAPHIQUES



Le point d'exclamation placé dans un triangle équilatéral est destiné à alerter l'utilisateur de la présence de directives importantes sur l'utilisation et l'entretien (dépannage) dans la documentation qui accompagne le produit.



L'éclair de foudre avec le symbole en pointe de flèche dans un triangle équilatéral est destiné à alerter l'utilisateur de la présence d'une "tension dangereuse" non isolée circulant dans l'encoffrement du produit et qui peut avoir une puissance suffisante pour constituer un risque d'électrocution.

NOTIFICATION IMPORTANTE: Tous les produits électroniques Yamaha sont vérifiés et approuvés par un laboratoire de contrôle de sécurité indépendant pour que vous puissiez être sûr que quand il est correctement installé et utilisé de façon normale et habituelle, tous les risques prévisibles ont été éliminés. NE modifiez PAS cet appareil ni déléguez d'autres personnes à le faire à moins d'être autorisé spécifiquement par Yamaha à le faire. Les performances de ce produit et/ou les normes de sécurité peuvent être diminuées. Les réclamations soumises sous les termes de la garantie exprimée peuvent être refusées si l'appareil est ou a été modifié. Des garanties implicites peuvent également être affectées.

CARACTÉRISTIQUES SUJETTES À MODIFICATION: On pense que les informations contenues dans ce manuel sont correctes au moment de l'impression. Cependant, Yamaha se réserve le droit de changer ou de modifier toute caractéristique sans avis préalable ni obligation de mettre à jour les appareils existants.

PUBLICATION SUR L'ENVIRONNEMENT: Yamaha s'efforce de produire des appareils qui réunissent à la fois la sécurité à utilisateur et constituent un environnement convivial. Nous croyons sincèrement que nos produits et les méthodes de production les produisant, atteignent ces buts. En accord avec la lettre et l'esprit de la loi, nous voulons que vous vous rendiez compte de ce qui suit :

Notification relative à la batterie: Ce produit PEUT contenir une petite batterie non-rechargeable qui (quand ceci est applicable) est soudée en place. La durée moyenne de ce type de batterie est approximativement de cinq ans. Quand le remplacement devient nécessaire, prenez contact avec un technicien qualifié pour exécuter le remplacement.

Avertissement: N'essayez pas de recharger, démonter ou incinérer ce type de batterie. Maintenez toutes les batteries hors de la portée des enfants. Mettez les batteries usées au rebut et promptement conformément aux obligations imposées par les lois applicables. Remarque: Dans certains secteurs, il est exigé par la loi que le préposé à l'entretien renvoie les pièces défectueuses. Cependant, vous avez l'option que le préposé à l'entretien mette ces pièces au rebut pour vous.

Notification de mise au rebut: Si ce produit était endommagé au delà de la possibilité du dépannage, ou pour quelque raison si sa durée de vie utile est considérée comme arrivant à terme, veuillez respecter la réglementation d'état, locale et fédérale et qui est associée à la mise au rebut des produits qui contiennent du plomb, des batteries, des plastiques, etc.

NOTIFICATION: Les frais administratifs encourus en raison d'un manque de connaissance concernant la façon dont une fonction ou des effets réagissent (quand l'appareil est utilisé comme conçu) ne sont pas couverts par la garantie du constructeur, et incombent pour cette raison la responsabilité des propriétaires. Veuillez étudier attentivement ce manuel et consultez votre distributeur avant de demander un dépannage.

EMPLACEMENT DE LA PLAQUE SIGNALÉTIQUE: La représentation graphique ci-dessous indique l'emplacement de la plaque signalétique. Le numéro de modèle, le numéro de série, les conditions d'alimentation électrique, etc., sont mentionnées sur cette plaque. Vous devriez enregistrer le numéro de modèle, le numéro de série et la date de l'achat dans les espaces fournis ci-dessous et conserver ce manuel comme relevé permanent de votre achat.

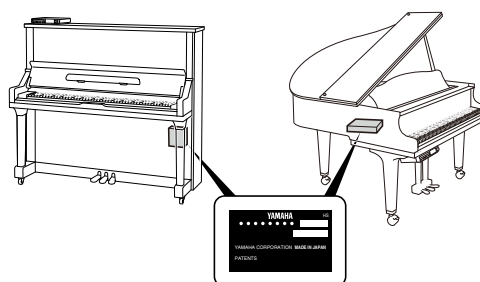

Modèle _____

Numéro de série _____

Date d'achat _____

IMPORTANT SAFETY INSTRUCTIONS

WARNING — When using any electrical or electronic product, basic precautions should always be followed. These precautions include, but are not limited to, the following:

1. Read these instructions.
2. Keep these instructions.
3. Heed all warnings.
4. Follow all instructions.
5. Do not use this apparatus near water.
6. Clean only with dry cloth.
7. Do not block any ventilation openings. Install in accordance with the manufacturer's instructions.
8. Do not install near any heat sources such as radiators, heat registers, stoves, or other apparatus (including amplifiers) that produce heat.
9. Do not defeat the safety purpose of the polarized or grounding-type plug. A polarized plug has two blades with one wider than the other. A grounding type plug has two blades and a third grounding prong. The wide blade or the third prong are provided for your safety. If the provided plug does not fit into your outlet, consult an electrician for replacement of the obsolete outlet.
10. Protect the power cord from being walked on or pinched particularly at plugs, convenience receptacles, and the point where they exit from the apparatus.
11. Only use attachments/accessories specified by the manufacturer.
12. Use only with the cart, stand, tripod, bracket, or table specified by the manufacturer, or sold with the apparatus. When a cart is used, use caution when moving the cart/apparatus combination to avoid injury from tip-over. 
13. Unplug this apparatus during lightning storms or when unused for long periods of time.
14. Refer all servicing to qualified service personnel. Servicing is required when the apparatus has been damaged in any way, such as power-supply cord or plug is damaged, liquid has been spilled or objects have fallen into the apparatus, the apparatus has been exposed to rain or moisture, does not operate normally, or has been dropped.
15. This product shall not be exposed to dripping or splashing and that no objects filled with liquids, such as vases, shall be placed on the apparatus.
16. Do not put burning items, such as candles, on the apparatus.
17. Do not place this product or any other objects on the power cord or place it in a position where anyone could walk on, trip over, or roll anything over power or connecting cords of any kind. The use of an extension cord is not recommended! If you must use an extension cord, the minimum wire size for a 25' cord (or less) is 18 AWG. NOTE: The smaller the AWG number, the larger the current handling capacity. For longer extension cords, consult a local electrician.
18. **WARNING** — To reduce the risk of fire or electric shock, do not expose this apparatus to rain or moisture.
19. Care should be taken that objects do not fall and liquids are not spilled into the enclosure through any openings that may exist.
20. This product, either alone or in combination with an amplifier and headphones or speaker/s, may be capable of producing sound levels that could cause permanent hearing loss. DO NOT operate for a long period of time at a high volume level or at a level that is uncomfortable. If you experience any hearing loss or ringing in the ears, you should consult an audiologist. IMPORTANT: The louder the sound, the shorter the time period before damage occurs.
21. Some Yamaha products may have benches and/or accessory mounting fixtures that are either supplied as a part of the product or as optional accessories. Some of these items are designed to be dealer assembled or installed. Please make sure that benches are stable and any optional fixtures (where applicable) are well secured BEFORE using. Benches supplied by Yamaha are designed for seating only. No other uses are recommended.
22. This product shall be connected to a MAINS socket outlet with a protective earthing connection.
23. This product has a power switch for shutting off all system. The switch is located on the Power Supply Unit nearby the entrance of the AC cord. Note that the switch on the Controller does not shutdown all system.
24. Make sure that the plug of the Power Supply Unit's power cable can easily be disconnected from the AC outlet as a measure of precaution.

Battery

- Danger of explosion if battery incorrectly replaced. Replace only with the same type.

Outlets for Speakers

- Connect speakers of 2A or less of totals. Do not connect other products except speakers.
- Consult Yamaha service technician when using the outlets outside the purchased area.

INSTRUCTIONS DE SÉCURITÉ IMPORTANTES

AVERTISSEMENT — Lors de l'utilisation de n'importe quel appareil électrique ou électronique, les précautions fondamentales devraient toujours être suivies. Ces précautions comprennent, mais ne sont pas limitées à, ce qui suit:

1. Lisez ces directives.
2. Conservez ces directives.
3. Observez tous les avertissements.
4. Suivez toutes les directives.
5. N'utilisez pas cet appareil près de l'eau.
6. Nettoyez seulement avec un tissu sec.
7. Ne bloquez aucune des ouvertures de ventilation. Installez conformément aux directives du constructeur.
8. N'installez près d'aucune source de chaleur telle que des radiateurs, des registres de chaleur, des appareils de chauffage ou d'autres appareils (amplificateurs y compris) qui produisent de la chaleur.
9. N'asservissez pas l'objectif de sécurité de la prise de type polarisée ou de mise à la terre. Une prise polarisée a deux lames avec une plus large que l'autre. Une prise de type à mise à la terre a deux lames et une troisième lame de mise à la terre. La lame large ou la troisième lame est prévue pour votre sécurité. Si la prise fournie ne s'ajuste pas dans votre prise secteur, consultez un électricien pour le remplacement de l'ancien modèle de prise.
10. Protégez le cordon d'alimentation de secteur afin que personne ne puisse marcher ni le pincer en particulier les prises, les prises de courant et la position où il quitte de l'appareil.
11. Utilisez seulement les équipements ou accessoires indiqués par le constructeur.
12. Utilisez seulement avec le chariot, le support, le trépied, la platine de fixation ou la table indiquée par le constructeur, ou vendue avec l'appareil. Quand un chariot est utilisé, faites attention en déplaçant la combinaison chariot/appareil pour éviter de se blesser en renversant l'appareil. 
13. Débranchez cet appareil pendant les orages et la foudre ou s'il est inutilisé pendant de longues périodes.
14. Confiez toutes les opérations d'entretien au personnel de service qualifié. L'entretien est exigé quand l'appareil a été endommagé de quelque façon que ce soit, comme par exemple l'endommagement du cordon ou de la prise d'alimentation secteur, quand du liquide a été renversé ou que des objets sont tombés dans l'appareil, l'appareil a été exposé à la pluie ou à l'humidité, ne fonctionne pas normalement ou est tombé par terre.
15. Ce produit ne doit pas être exposé à un suintement ou des éclaboussures et aucun objet rempli de liquide, tels que des vases, ne doit être mis sur l'appareil.
16. Ne mettez pas des articles brûlants, tels que des bougies, sur l'appareil.
17. Ne placez ce produit ni aucun autre objet sur le cordon d'alimentation secteur ou ne le placez pas dans une position où n'importe qui pourrait marcher dessus, trébucher dedans ou faire rouler n'importe quoi sur les cordons d'alimentation en aucune manière. L'utilisation d'un cordon prolongateur n'est pas recommandée ! Si vous devez utiliser un cordon prolongateur, la taille minimum du calibre de fil du cordon pour un cordon de 25 pouces (ou moins) est de 18 du calibre américain normalisé. **REMARQUE:** Plus le numéro du calibre américain normalisé est petit, plus la capacité de gestion de l'intensité est grande. Pour de plus longs cordons prolongateurs, consultez un électricien local.
18. **AVERTISSEMENT** — Pour réduire les risques d'incendie ou de décharge électrique, n'exposez pas cet appareil à la pluie ou à l'humidité.
19. Un soin tout particulier devrait être pris pour qu'aucun objet ne tombe et que des liquides ne soient renversés dans l'encoffrement par aucune des ouvertures qui peuvent exister.
20. Ce produit, individuel ou en combinaison avec un amplificateur et des écouteurs ou le ou les haut-parleurs, risque de produire des niveaux sonores qui pourraient causer une perte d'auditive permanente. **NE PAS** mettre en service pendant une longue période à un niveau de volume élevé ou à un niveau qui est inconfortable. Si vous éprouvez n'importe quelle sorte de perte auditive ou de sonnerie dans les oreilles, vous devriez consulter un audiologiste. **IMPORTANT :** Plus le son est fort, plus la période de temps avant que les dégâts se produisent est courte.
21. Certains produits Yamaha peuvent avoir des supports et/ou des accessoires d'installation complémentaires qui sont fournis comme partie du produit ou en tant qu'accessoires optionnels. Certains de ces articles sont conçus pour être montés ou installés par le distributeur. Veuillez vous assurer que les supports sont stables et que tous les accessoires optionnels (quand ceci est applicable) sont bien fixés **AVANT** l'utilisation. Les supports fournis par Yamaha sont conçus pour un positionnement seulement. Aucune autre utilisation n'est recommandée.
22. Ce produit doit être connecté à une prise de sortie secteur munie d'une connexion protectrice par la mise à la terre.
23. Ce produit est muni d'un interrupteur d'alimentation permettant de couper l'alimentation de tout le système. L'interrupteur d'alimentation est installé sur le bloc d'alimentation tout près l'entrée du cordon d'alimentation secteur. Notez que l'interrupteur d'alimentation sur le contrôleur n'arrête tout le système.
24. Assurez-vous que la prise du cordon d'alimentation électrique du bloc d'alimentation peut facilement être débranchée de la prise de sortie secteur comme mesure de précaution.

Batterie

- Risque d'explosion si la batterie n'est pas remplacée comme il faut. Remplacez seulement par le même type de batterie.

Prises de sortie pour des haut-parleurs

- Connectez des haut-parleurs de 2A ou moins au total. Ne connectez aucun autre produit excepté des haut-parleurs.
- Consultez le technicien de service Yamaha quand des prises sont utilisées en dehors du secteur d'achat.

IMPORTANT NOTICE FOR THE UNITED KINGDOM

Connecting the Plug and Cord

IMPORTANT: The wires in mains lead are coloured in accordance with the following code:

GREEN-AND-YELLOW : EARTH
BLUE : NEUTRAL
BROWN : LIVE

As the colours of the wires in the mains lead of this apparatus may not correspond with the coloured markings identifying the terminals in your plug, proceed as follows:

The wire which is coloured GREEN and YELLOW must be connected to the terminal in the plug which is marked by the letter E or by the safety earth symbol or coloured GREEN and YELLOW.

The wire which is coloured BLUE must be connected to the terminal which is marked with the letter N or coloured BLACK.

The wire which is coloured BROWN must be connected to the terminal which is marked with the letter L or coloured RED.

The control unit is classified as a Class 1 laser product. One of the labels below is located on the inside of the CD drive unit.

L'unité de commande est classée produit laser de Classe 1. Une des étiquettes ci-dessous ou une étiquette similaire se trouve à l'intérieur du lecteur de CD.

CLASS 1 LASER PRODUCT
LASER KLASSE 1
1类激光产品

CAUTION - CLASS 3B VISIBLE AND INVISIBLE LASER RADIATION
WHEN OPEN.
AVOID EXPOSURE TO THE BEAM.
VORSICHT - SICHTBARE UND UNSICHTBARE LASERSTRAHLUNG
KLASSE 3B, WHEN GEÖFFNET.
NICHT DEM STRAHL AUSSETZEN.
注意 - 打开时有3B类可见及不可见激光辐射
避免光束照射

Laser Diode Properties

- * Material: GaAlAs
- * Wavelength: 783 nm
- * Laser Output Power at the lens of the Laser Pickup Unit: max. 130.7 mW

Propriétés de la diode à semi-conducteur

- * Matériau : GaAlAs
- * Longueur d'ondes : 783 nm
- * Puissance de sortie laser à la lentille du capteur laser : 130.7 mW max.

CAUTION—Use of controls or adjustments or performance of procedures other than those specified herein may result in hazardous radiation exposure.

ATTENTION—L'utilisation de commandes ou de réglages, ou l'exécution de procédures, autres que celles qui sont spécifiées ici peuvent conduire à une exposition à des rayonnements dangereux.

Information for Users on Collection and Disposal of Old Equipment and used Batteries



These symbols on the products, packaging, and/or accompanying documents mean that used electrical and electronic products and batteries should not be mixed with general household waste.

For proper treatment, recovery and recycling of old products and used batteries, please take them to applicable collection points, in accordance with your national legislation and the Directives 2002/96/EC and 2006/66/EC.

By disposing of these products and batteries correctly, you will help to save valuable resources and prevent any potential negative effects on human health and the environment which could otherwise arise from inappropriate waste handling.

For more information about collection and recycling of old products and batteries, please contact your local municipality, your waste disposal service or the point of sale where you purchased the items.

[For business users in the European Union]

If you wish to discard electrical and electronic equipment, please contact your dealer or supplier for further information.

[Information on Disposal in other Countries outside the European Union]

These symbols are only valid in the European Union. If you wish to discard these items, please contact your local authorities or dealer and ask for the correct method of disposal.

Note for the battery symbol (bottom two symbol examples):

This symbol might be used in combination with a chemical symbol. In this case it complies with the requirement set by the Directive for the chemical involved.



Cd

Information concernant la Collecte et le Traitement des piles usagées et des déchets d'équipements électriques et électroniques



Les symboles sur les produits, l'emballage et/ou les documents joints signifient que les produits électriques ou électroniques usagés ainsi que les piles ne doivent pas être mélangés avec les déchets domestiques habituels.

Pour un traitement, une récupération et un recyclage appropriés des déchets d'équipements électriques et électroniques et des piles usagées, veuillez les déposer aux points de collecte prévus à cet effet, conformément à la réglementation nationale et aux Directives 2002/96/EC et 2006/66/EC.

En vous débarrassant correctement des déchets d'équipements électriques et électroniques et des piles usagées, vous contribuerez à la sauvegarde de précieuses ressources et à la prévention de potentiels effets négatifs sur la santé humaine qui pourraient advenir lors d'un traitement inapproprié des déchets.

Pour plus d'informations à propos de la collecte et du recyclage des déchets d'équipements électriques et électroniques et des piles usagées, veuillez contacter votre municipalité, votre service de traitement des déchets ou le point de vente où vous avez acheté les produits.

[Pour les professionnels dans l'Union Européenne]

Si vous souhaitez vous débarrasser des déchets d'équipements électriques et électroniques veuillez contacter votre vendeur ou fournisseur pour plus d'informations.

[Information sur le traitement dans d'autres pays en dehors de l'Union Européenne]

Ces symboles sont seulement valables dans l'Union Européenne. Si vous souhaitez vous débarrasser de déchets d'équipements électriques et électroniques ou de piles usagées, veuillez contacter les autorités locales ou votre fournisseur et demander la méthode de traitement appropriée.

Note pour le symbole « pile » (deux exemples de symbole ci-dessous) :

Ce symbole peut être utilisé en combinaison avec un symbole chimique. Dans ce cas il respecte les exigences établies par la Directive pour le produit chimique en question.



Cd

**COMPLIANCE INFORMATION STATEMENT
(DECLARATION OF CONFORMITY PROCEDURE)**

Responsible Party : Yamaha Corporation of America
Address : 6600 Orangethorpe Avenue, Buena Park, CA 90620 USA
Telephone : 1-714-522-9011
Fax : 1-714-522-9301
Type of Equipment : Player Piano
Model Name : DGB1KE3, DGC1E3, DGC2E3, DC1E3, DC2E3, DU1E3, DYUS1E3, 200E3, 200CSE3

This device complies with Part 15 of the FCC Rules.

Operation is subject to the following two conditions:

- 1) this device may not cause harmful interference, and
 - 2) this device must accept any interference received including interference that may cause undesired operation.
- See user manual instructions if interference to radio reception is suspected.

The above statements apply ONLY to those products distributed by Yamaha Corporation of America or its subsidiaries.

FCC INFORMATION (U.S.A.)

1. IMPORTANT NOTICE: DO NOT MODIFY THIS UNIT!

This product, when installed as indicated in the instructions contained in this manual, meets FCC requirements. Modifications not expressly approved by Yamaha may void your authority, granted by the FCC, to use the product.

2. IMPORTANT: When connecting this product to accessories and/or another product use only high quality shielded cables. Cable/s supplied with this product MUST be used. Follow all installation instructions. Failure to follow instructions could void your FCC authorization to use this product in the USA.

3. NOTE: This product has been tested and found to comply with the requirements listed in FCC Regulations, Part 15 for Class "B" digital devices. Compliance with these requirements provides a reasonable level of assurance that your use of this product in a residential environment will not result in harmful interference with other electronic devices. This equipment generates/uses radio frequencies and, if not installed and used according to the instructions found in the users manual, may cause interference harmful to the operation of other electronic devices. Compliance with FCC regulations does not guarantee that interference will not occur in all installations. If this product is found to be the source of interference, which can be determined by turning the unit "OFF" and "ON", please try to eliminate the problem by using one of the following measures:

Relocate either this product or the device that is being affected by the interference.

Utilize power outlets that are on different branch (circuit breaker or fuse) circuits or install AC line filter/s.

In the case of radio or TV interference, relocate/reorient the antenna. If the antenna lead-in is 300 ohm ribbon lead, change the lead-in to coaxial type cable.

If these corrective measures do not produce satisfactory results, please contact the local retailer authorized to distribute this type of product. If you can not locate the appropriate retailer, please contact Yamaha Corporation of America, Electronic Service Division, 6600 Orangethorpe Ave, Buena Park, CA 90620

The above statements apply ONLY to those products distributed by Yamaha Corporation of America or its subsidiaries.

Mounting the Control Unit to the Grand Piano

Installation du boîtier de commande sur un piano à queue

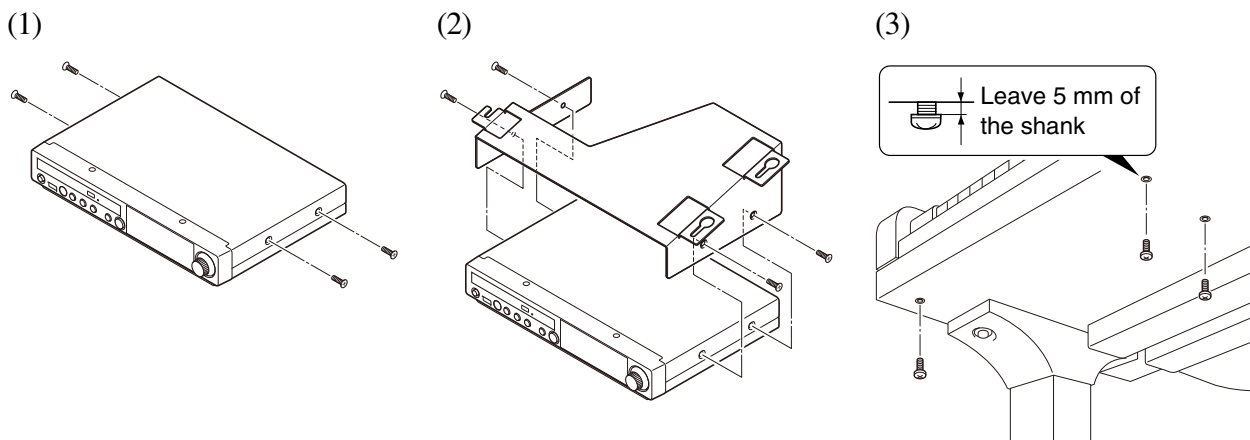

- (1) Remove the four screws from the sides of the control unit.
- (2) Place the metal suspension bracket, supplied with the Disklavier grand model, over the control unit, then secure the metal suspension bracket to the control unit using the four screws (4 × 10) supplied with the Disklavier.
- (3) Insert the three restraining screws (5 × 12) into the marked nuts underneath the bass side key bed, then tighten the screws, leaving a gap of about 5 mm between head of the screw and piano body.

Notes:

- 1) Handle the metal suspension bracket and the control unit carefully to avoid scratches.
- 2) Screws;
For suspension bracket installation:
Flat head (4 × 10) × 4
For control unit suspension:
Bind head (5 × 12) × 3
- 3) When mounted correctly, the control unit is angled approximately 18° above horizontal.

- (1) Retirer les quatre vis sur les côtés du boîtier de commande.
- (2) Placez la platine de fixation de suspension en métal, fournie avec le modèle Grand Disklavier, au-dessus du boîtier de commande, puis fixez la platine de fixation de suspension en métal au boîtier de commande en utilisant les quatre vis (4 × 10) fournies avec le Disklavier.
- (3) Introduire les trois vis de fixation (5 × 12) dans les écrous marqués sous le clavier du côté de la basse, puis serrer les vis en laissant un espace d'environ 5 mm entre la tête de la vis et le corps du piano.

Remarques:

- 1) Manipuler soigneusement le support métallique et le boîtier de commande pour éviter les rayures.
- 2) Vis de fixation;
Pour l'installation de la platine de fixation de suspension:
Tête plate (4 × 10) × 4
Pour la suspension de l'unité de commande:
Tête de grippage (5 × 12) × 3
- 3) Lorsqu'il est monté correctement, le boîtier de commande est incliné d'environ 18° sur l'horizontale.

(4) (5)

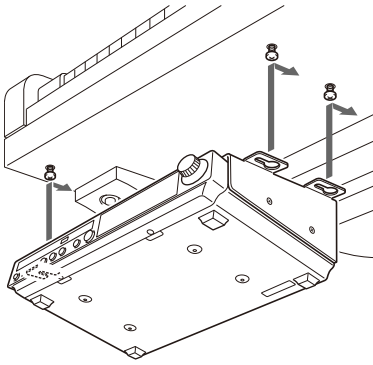

(6)

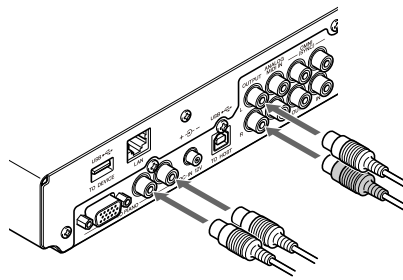

(4) Fit the “slots” of the metal suspension bracket containing the control unit to the screws mentioned in step (3).

(5) After mounting the control unit, push the control unit back as far as it will go and then tighten the three screws to secure the bracket.

(6) Connect the cables extending from the piano to the appropriate connectors/jacks on the rear panel of the control unit.

- Coaxial cable: to the TO PIANO connectors
- Speaker cord*: to the OUTPUT jacks

* Only for models supplied with the monitor speakers.

(4) Glisser les « fentes » du support métallique contenant le boîtier de commande sur les vis mentionnées à l'étape (3).

(5) Après avoir installé le boîtier de commande, l'enfoncer jusqu'à l'extrémité et serrer les trois vis pour fixer le support.

(6) Connectez les câbles sortant du piano aux connecteurs ou aux prises appropriées sur le panneau arrière de l'unité de commande.

- Câble coaxial : aux connecteurs TO PIANO
- Cordon de haut-parleur*: aux prises OUTPUT

* Seulement pour les modèles fournis avec les haut-parleurs de contrôle.

Mounting an Optional USB Floppy Disk Drive to the Grand Piano

Installation d'unité de disquette USB optionnelle sur le piano à queue

(1)

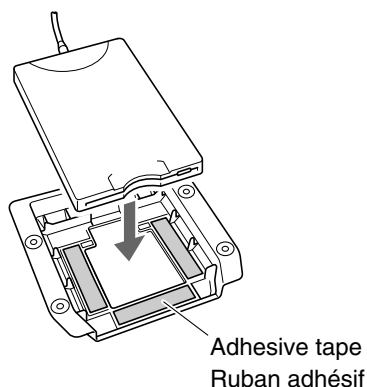

(2)

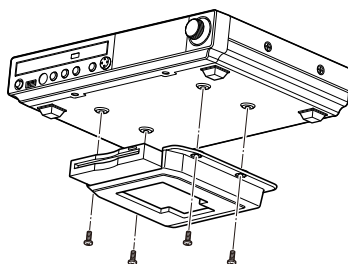

(3)

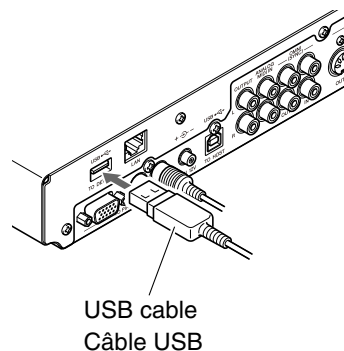

- (1) Remove the backing papers from the adhesive tape inside the case, and fit the floppy disk drive into the case.
- (2) Attach the drive and case assembly to the bottom of the control unit, using the four screws (3 × 6) supplied with the Disklavier.
- (3) Connect the USB cable extending from the drive to the USB port on the rear panel of the control unit.

Notes:

- 1) The case is supplied with the USB floppy disk drive.
- 2) Use the screws (3 × 6) supplied with the Disklavier when attaching.

- (1) Enlevez les papiers arrière du ruban adhésif à l'intérieur du boîtier et insérez l'unité de disquette dans le boîtier.
- (2) Fixez l'ensemble de lecteur et de boîtier au fond de l'unité de commande en utilisant les quatre vis (3 × 6) fournies avec le Disklavier.
- (3) Raccordez le câble USB sortant du lecteur au port USB sur le panneau arrière de l'unité de commande.

Remarques:

- 1) Le boîtier est fourni avec l'unité de disquette USB.
- 2) Utilisez les vis de fixation (3 × 6) fournies avec le Disklavier au moment de faire la fixation.

disklavier™ 

Operation manual

Welcome to the Yamaha Disklavier™!

Thank you for purchasing the Yamaha Disklavier piano!

The Disklavier is a fascinating instrument that integrates a classic Yamaha acoustic piano with innovative electronics to suit your entertainment, educational, and creative needs, while retaining the tone, touch and long-term value that have long made Yamaha pianos the world's finest.

Before using your Disklavier piano, please read this manual thoroughly and retain it for future reference.

■ Notes on Source Code Distribution

For three years after the factory shipment, you may request from Yamaha the source code for any portions of the product which are licensed under the GNU General Public License by writing to the following address:

10-1 Nakazawa-cho, Naka-ku, Hamamatsu, Shizuoka, 430-8650, JAPAN
Piano Development Department, Yamaha Corporation

The source code will be provided at no charge; however, we may require you to reimburse Yamaha for the cost of delivering the source code to you.

The source code download is also available on the following website:

http://download.yamaha.com/sourcecodes/disklavier_e3/

- Note that we shall bear no responsibility whatsoever for any damage arising from changes (additions/deletions) made to the software for this product by a third party other than Yamaha (or party authorized by Yamaha).
- Note that re-use of source code released to the public domain by Yamaha is unguaranteed, and Yamaha shall not bear any responsibility whatsoever for the source code.

■ Trademarks & Copyrights

- The contents of this operation manual and the copyrights thereof are under exclusive ownership by Yamaha Corporation.
- Yamaha, Disklavier, DisklavierRadio, Silent, PianoSoft, PianoSoft-Plus, and PianoSoft-PlusAudio are trademarks of Yamaha Corporation.
- SmartKey, CueTIME, and You Are The Artist are trademarks of Yamaha Corporation or Yamaha Corporation of America.
- Disklavier E3 software, Copyright © 2008 Yamaha Corporation.
- This contains programs licensed under the GNU General Public License, GNU Lesser General Public License, the BSD Copyright, the Artistic License, and the others.
- This product includes software developed by the OpenSSL Project for use in the OpenSSL Toolkit. (<http://www.openssl.org/>)
- Windows is a registered trademark of Microsoft Corporation in the United States and other countries.
- Macintosh and Mac OS are trademarks of Apple Inc., registered in the U.S. and other countries.
- The company names and product names in this operation manual are the trademarks or registered trademarks of their respective companies.

Important Precautions

Read the following before operating the Disklavier.

■ Warnings

- Do not locate the Disklavier in a place subject to excessive heat, low temperatures, or direct sunlight. This could be a fire hazard and may damage the finish and internal parts.
- Excessive humidity or dust can lead to fire or electric shock.
- Connect the plug on the Disklavier power cable to a compatible AC outlet. Failure to do so will present a fire and electric shock hazard. If the power cable plug is not compatible with your AC outlet, consult your dealer.
- Do not plug several devices into the same AC outlet. This can overload the AC outlet, and lead to fire and electric shock hazard. It may also affect the performance of some devices.
- Do not place heavy objects on the power cable. A damaged power cable is a potential fire and electric shock hazard. If the power cable runs under a carpet, make sure heavy objects, including the Disklavier, are not placed on top of the cable.
- If the power cable is damaged (i.e. cut or a bare wire is exposed), ask your dealer for a replacement. Using the Disklavier in this condition is a fire and shock hazard.
- When disconnecting the power cable from an AC outlet, always pull from the plug. Never pull the cable. Damaging the cable in this way is a potential fire and electric shock hazard.
- The cover of the unit should be removed only by qualified service technicians.
- Do not place liquid containers such as vases, potted plants, glasses, cosmetic bottles, medicines, etc., on top of the Disklavier.
- Do not try to modify the Disklavier, as this could lead to fire or electric shock hazard.
- When moving the Disklavier to another location, turn off the power, remove the power plug from the AC outlet, and remove all cables connected to external devices.

■ Cautions

- Turn off all audio devices when connecting to the Disklavier. Refer to the user's guide for each device. Use the correct cables and connect as specified.
- Set the volume level on all the devices to minimum before applying power.
- Do not play the Disklavier at a high volume for extended periods; you may damage your hearing. This is especially important when using headphones. If you think your hearing ability is impaired, consult your doctor.
- If the Disklavier is worked extremely hard —that is, prolonged playback of very “busy” songs — the Disklavier's thermal relay may trip. The thermal relay will automatically reset when the Disklavier has cooled down.
- If you notice any abnormality — such as smoke, odor, or noise — turn off the Disklavier immediately, and remove the power plug from the AC outlet. Consult your dealer for repair.
- If a foreign object or water gets inside the Disklavier turn it off immediately, and remove the power plug from the AC outlet. Consult your dealer.
- If you plan not to use the Disklavier for a long period of time (such as when you are on vacation), disconnect the electrical mains.
- Always remove the power plug from the AC outlet before cleaning the Disklavier. Leaving the power plug connected presents a risk of electric shock.
- Do not use benzene, thinner, cleaning detergent, or a chemical cloth to clean the Disklavier.
- Do not place metal objects with rubber feet on top of the Disklavier. The color and finish of the Disklavier can be damaged.
- Do not place heavy objects on the Disklavier. Doing so can damage the Disklavier.
- Use a soft, dry cloth to clean the Disklavier. However, if you discover a stain, carefully use a soft damp cloth to remove it.

■ Interference

- The Disklavier uses high-frequency digital circuits that may cause interference to radios and TVs placed close to it. If interference does occur, relocate the affected equipment.

■ Handling Batteries

The remote control of this unit is powered by dry batteries. Improper use or misuse of the dry batteries can cause the dry batteries to heat up, leak electrolyte or burst which in turn may result in a fire, damage to equipment and/or nearby objects or in burns, injury or other bodily harm. Read through and familiarize yourself with the following safety precautions prior to use to ensure correct usage.

- Do not directly touch the chemicals (electrolyte) which have leaked from dry batteries.
 1. If electrolyte from dry batteries has made contact with your eyes, rinse your eyes thoroughly with clean water and seek medical treatment from a physician immediately.
 2. If electrolyte from dry batteries has touched your skin or clothing, rinse it off immediately with clean water.
 3. If electrolyte from dry batteries has found its way inside your mouth, gargle immediately and consult a physician.
- Do not install the dry batteries with the “+” and “-” poles reversed. Misaligning the poles of dry batteries can lead the dry batteries to be charged or shorted or it can cause them to heat up, leak electrolyte or burst which in turn may result in a fire, damage to nearby objects or in burns, injury or other bodily harm.
- Use only the designated batteries. Do not use used batteries with unused batteries or different types of batteries together. This can cause them to heat up, leak electrolyte or burst which in turn may result in a fire or in burns, injury or other bodily harm. Replace all the dry batteries at the same time. Do not use new and old dry batteries together. Do not use different types of batteries (alkaline and manganese batteries, batteries made by different manufacturers or different battery products made by the same manufacturer) together: this can cause them to heat up, ignite or leak electrolyte.
- When the battery-powered unit is not going to be used for a prolonged period of time, remove the dry batteries from the unit. Otherwise the batteries will run down and their electrolyte may leak, resulting in damage to the unit.
- Remove spent batteries immediately from equipment. Otherwise, batteries will overdischarge, causing them to heat up, leak electrolyte or burst which in turn may result in damage to nearby objects or in burns, injury or other bodily harm.
- Dispose of batteries in accordance with the applicable regulations and ordinances.
- The batteries shall not be exposed to excessive heat such as sunshine, fire or the like.

Please keep this manual for future reference.

Table of Contents

Chapter 1 Introduction

Features	1
Items Supplied with the Disklavier	1
Names of Parts and Their Functions	2
Basic Disklavier Terminology	7

Chapter 2 Getting Started

Connecting the Control Unit	8
Connecting the AC Power Cable	8
Using the Remote Control	9
Turning On the Disklavier	10
Setting the Internal Calendar	11
Turning Off the Disklavier (Standby Mode)	14
Shutting Down the Disklavier	14
Compatible Media Format for the Removable Media	14
Compatible File Format	15
Basic Precautions for Using CDs	15

Chapter 3 Basic Song Playback

Types of Playable Software	16
Selecting Medium and Their Contents	17
Using the Number Keypad	19
Starting Playback	19
Stopping Playback	21
Pausing Playback	21
Fast Preview & Review	22
Fast Forward & Reverse	23
Searching a Specific Section of a Song	24
Listening to the DisklavierRadio™	25
Adjusting the Volume	26

Chapter 4 Advanced Song Playback

Changing the Playback Tempo	27
Playing Back Songs in a Different Key (Transposition)	27
Repeating Song Playback	28
Repeating a Specific Section of a Song (A-B Repeat)	29
Playing Back Only the Desired Piano Part	30
Adjusting the Volume Balance among the Keyboard Playing, Ensemble Sound, and Software Playback	31
Adjusting the Pitch of Audio	33

Adjusting the L/R Balance of Audio	34
Using the Timer Play	35
Skipping the Blank Part at the Beginning of a Song	38
Video Synchronized Playback	39
Adding Disklavier Accompaniment to Commercial CD Songs (PianoSmart™ Playback)	40
SmartKey™ Playback	40

Chapter 5 Advanced Piano Playing

Playing the Disklavier along with the Internal Metronome	42
Playing the Disklavier with an Ensemble Voice	43

Chapter 6 Basic Recording

Recording a New Song	45
Titling a Song at the Start of Recording	46

Chapter 7 Advanced Recording

Recording with the Internal Metronome	48
Recording the Left and Right Parts Separately ...	50
Recording the Left and Right Parts Together (Setting a Split Point)	52
Re-Recording One Part	54
Changing the Default Tempo	55
Video Synchronized Recording	57
CD Synchronized Recording	61

Chapter 8 Media Management

Managing Albums	62
Making Copies of Albums	62
Deleting Albums	64
Creating a New Album	65
Renaming an Album	66
Rearranging the Order of Albums	67
Managing Songs	68
Making Copies of Songs	69
Deleting Songs	70
Renaming a Song	71
Rearranging the Order of Songs	72
Converting Song Format	73
Changing the Counter Display	74
Converting MIDI Data to a Standard Form (Strip XP)	75

Managing Playlists	76
Adding Songs/Albums to the Playlist	77
Deleting a Playlist.....	78
Creating a New Playlist.....	79
Renaming a Playlist	80
Managing Media.....	81
Making Copies of the Entire Contents in a Medium	82
Deleting the Entire Contents in a Medium.....	83
Copying Song File from a Personal Computer to the Disklavier.....	84
Refreshing the Contents in [FromToPC].....	88
Formatting the Floppy Disk (Optional)	89
Making Backups of Songs.....	90
Restoring the Backups.....	91

Chapter 9 Internet Direct Connection (IDC)

What is Internet Direct Connection (IDC)?.....	93
Obtaining an ID and Password for the IDC Service (IDC Registration)	93
Connecting the Disklavier to the Internet	93
Accessing the Internet.....	95
Checking Your Account Information.....	96
Updating the Disklavier Using the Internet.....	97
Setting the Disklavier for the Internet Connection.....	99
Initializing Internet Settings	100

Chapter 10 Enhancing the Disklavier by Hooking Up Other Devices

Hooking Up Audio Equipment.....	101
Setting the Disklavier for Audio Data Reception/Transmission.....	102
Hooking Up MIDI Devices	104
Setting the Disklavier for MIDI Data Reception	105
Setting the Disklavier for MIDI Data Transmission.....	107
Setting the Disklavier for Keyboard Playing Data Transmission	108

Chapter 11 Other Settings

Tuning the Tone Generator (TG Master Tune).....	110
Assigning Frequently-used Functions to the Number Keypad on the Remote Control	111
Setting the Passcode to Prevent Unauthorized Access.....	114
Adjusting the Brightness of the Display.....	116
Switching the Languages for the Screen.....	117
Resetting the Disklavier.....	118
Diagnosing the Disklavier (Maintenance Mode)	120
Updating the Disklavier	121

Chapter 12 Internal Tone Generator Voices

Internal GM/XG Tone Generator Basic Voice List.....	123
Internal TG3 Tone Generator Basic Voice List.....	126

Chapter 13 Troubleshooting

Chapter 14 Error Messages

Chapter 15 Glossary.....

Chapter 16 Specifications

General Specifications	135
Function & Controls.....	136

Appendix Software License Notice....A-1 **MIDI Data Format**

MIDI IMPLEMENTATION CHART

Features

The Disklavier E3 offers the valuable features that open up your musical possibility to explore. Here are brief explanations of such features:

Advanced Features for Your Listening Pleasure

- Special music CDs, contain over 17 hours of fantastic music, let you start listening on the day the Disklavier E3 arrives at your home.
- DisklavierRadio; you can listen to over 11 music channel by streaming broadcasts over the Internet.

Convenient Recording Features to Preserve Your Musical Memories

- Total 128 megabytes of internal memory comes with the Disklavier E3 to preserve your valuable data.
- Connecting external USB devices to the Disklavier E3 allows you to record your performance directly onto them, or even make backups of your valuable data in the internal memory.
- Video synchronization features offer great listening experience with sights. You can see as well as hear performances with perfectly synchronized audio and video.
- Your valuable music data on the floppy disk can be played back with the optional floppy disk drive (UD-FD01).

Simple and Easy-to-use Features Enhancing Your Performance

- The remote control, with clear and logical layout of buttons, lets you quickly enjoy the features of the Disklavier E3.
- The display on the front panel employs an organic electro-luminescent display which makes it brighter and more easily readable than ever.

Items Supplied with the Disklavier

Check that the following items are supplied with your Disklavier:

- | | |
|--|---|
| • 1 Control unit | • 1 Operation manual |
| • 1 Control unit suspension bracket* ¹ | • 1 PianoSoft CD song list |
| • 4 Screws for control unit suspension bracket installation (4 × 10)* ¹ | • 1 Music book "50 greats for the Piano" |
| • 3 Screws for control unit suspension (5 × 12)* ¹ | <i>*¹ Only for grand pianos</i> |
| • 4 Screws for optional USB floppy disk drive installation (3 × 6)* ¹ | <i>*² Only for models supplied with the monitor speakers</i> |
| • 2 Monitor speakers* ² | |
| • 1 Monitor speaker installation kit* ² | |
| • 2 Speaker cords* ² | |
| • 1 Remote control | |
| • 2 Batteries for remote control | |
| • 2 Sample PianoSoft CD software | |
| • 1 Quick reference | |

Names of Parts and Their Functions

■ Control Unit — Front Panel

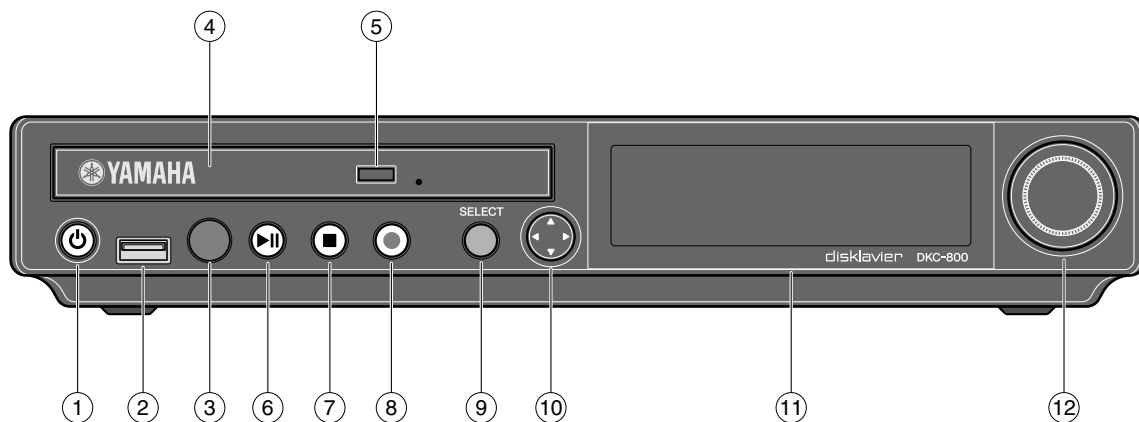

① **[ON/OFF] button**

Turns on or shuts down the Disklavier. Press once to turn it on, and once again to shut it down.

② **USB port**

Used to connect a USB flash memory, etc.

③ **Remote control sensor**

When using the remote control, point it toward this sensor.

④ **CD drive**

Insert a PianoSoft-PlusAudio or other audio or audio/MIDI CD here.

⑤ **CD eject button**

Used to open the CD drive.

⑥ **[PLAY/PAUSE] button**
(pages 19 and 21)

Used to start and pause playback.

⑦ **[STOP] button** (page 21)

Used to stop playback and recording.

⑧ **[RECORD] button** (page 45)

Used to engage the record standby mode before recording starts.

⑨ **[SELECT] button**

Used to select media.

⑩ **Cursor/[ENTER] buttons**

Cursor: Used to select options and parameters.

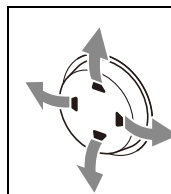

Press this button inclining slightly upward/downward/left/right.

[ENTER]: Used to execute the selection.



Press straight the center of this button.

⑪ **Display**

Shows various information.

⑫ **Dial**

Used to adjust the volume, and to set parameter values.

■ Control Unit — Rear Panel

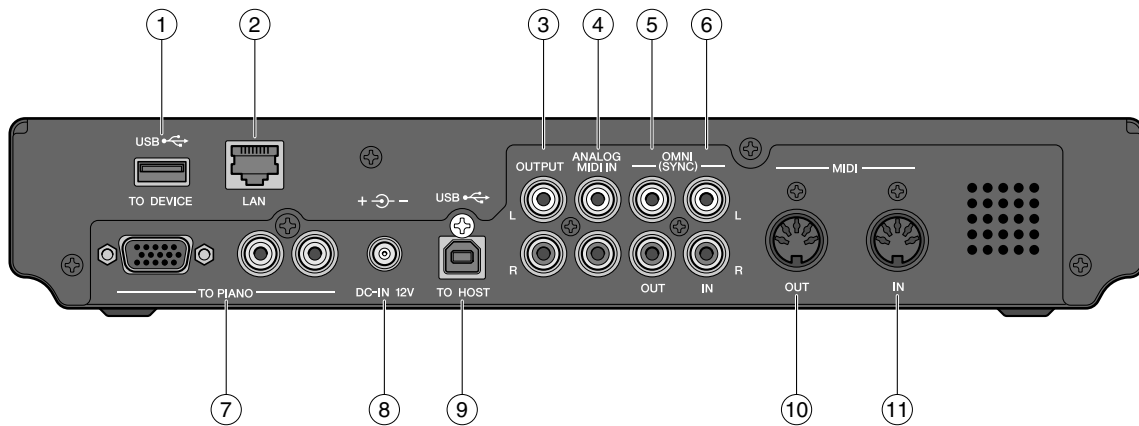

① USB TO DEVICE port

Used to connect a USB flash memory, an optional USB floppy disk drive, etc.

② LAN port

Used to connect to the Internet.

③ OUTPUT jacks

Used to connect the speaker cord from the monitor speakers*

④ ANALOG MIDI IN jacks

Used to connect the audio equipment such as an external CD changer.

⑤ OMNI (SYNC) OUT jacks

Used to connect the microphone/line input of a camcorder.

⑥ OMNI (SYNC) IN jacks

Used to connect the audio output of a camcorder.

⑦ TO PIANO connectors

Used to connect the piano.

⑧ DC-IN 12V connector

Used to connect to the power supply unit.

⑨ USB TO HOST port

Used to connect the USB cable from a computer.

⑩ MIDI OUT terminal

Used to connect external MIDI equipment for outputting MIDI data.

⑪ MIDI IN terminal

Used to connect external MIDI equipment for inputting MIDI data.

* Only for models supplied with the monitor speakers.

■ Remote Control

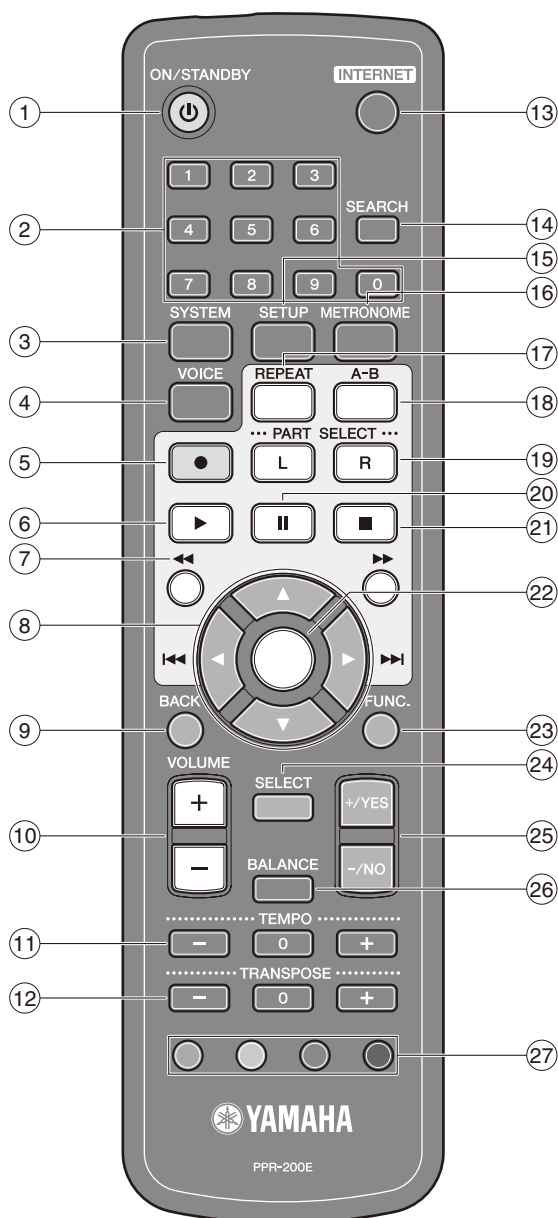

① **[ON/STANDBY] button**

Turns on the Disklavier or puts it in the standby mode.

② **Number keypad**

Used for direct album/song selection and to enter a start time for song playback.

③ **[SYSTEM] button**

Used to access the system menu.

④ **[VOICE] button**

Used to access the voice function.

⑤ **[RECORD] button**

Used to engage the record standby mode before recording starts.

⑥ **[PLAY] button**

Used to start playback.

⑦ **[REVERSE]/[FORWARD] buttons**

In the play mode: used to fast preview and review.
In the pause mode: used to fast forward and reverse.

⑧ **Cursor buttons**

Used to select options and parameters.

⑨ **[BACK] button**

Used to cancel the selection, and return to the previous screen.

⑩ **[VOLUME] buttons (☞ page 26)**

Used to adjust the volume.

[-] lowers the volume, [+] raises the volume.

⑪ **[TEMPO] buttons**

Used to change the playback tempo.

[-] decreases the tempo, [+] increases the tempo, and [0] resets the tempo to 00.

⑫ **[TRANPOSE] buttons**

Used to transpose song playback.

[-] transposes down, [+] transposes up, and [0] resets the transposition value to 00.

⑬ **[INTERNET] button**

Used to access the Internet menu.

⑭ **[SEARCH] button**

Used to access the search function.

⑮ **[SETUP] button**

Used to access the setup menu.

⑯ **[METRONOME] button**

Used to access the metronome function.

⑰ **[REPEAT] button**

Used to select one of the repeat modes: ALL, RPT, RND, or OFF.

⑱ **[A-B] button**

Used to enter A and B points for the A-B repeat mode.

⑲ **[PART SELECT] buttons**

For L/R and ensemble songs, these buttons are used to choose which part will play: left-hand part, right-hand part, or both parts.

They are also used to select a part for recording.

⑳ **[PAUSE] button (☞ page 21)**

Used to pause playback.

㉑ **[STOP] button (☞ page 21)**

Used to stop playback and recording.

㉒ **[ENTER] button**

Used to execute the selection.

㉓ **[FUNC.] button**

Used to access the function menu.

㉔ **[SELECT] button**

Used to select media.

㉕ **[+/YES]/[-/NO] buttons**

Used to select parameters, adjust setting values, and execute or cancel the selected functions.

㉖ **[BALANCE] button**

Used to adjust the TG, audio and voice balance.

㉗ **Color buttons**

Green: Used to execute the shortcut assigned to the number keypad.

Yellow: Used to switch character types when titling albums and songs.

Other: For future use.

■ Monitor Speaker*

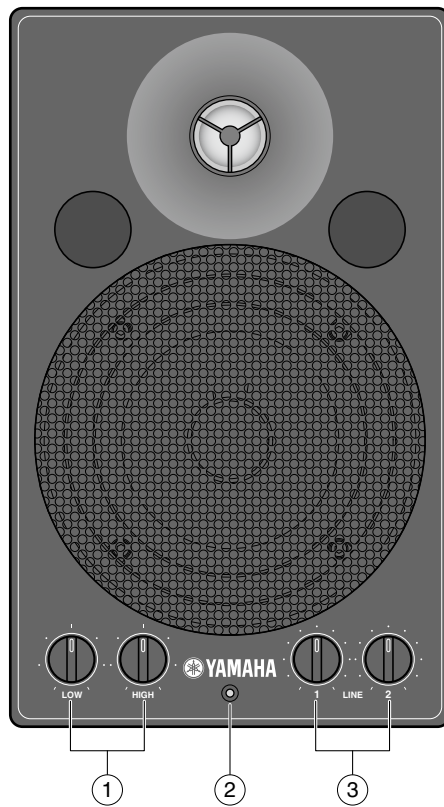

① **LOW/HIGH volume controls**
Adjust the base/treble sound volume.

② **Power indicator**
Lights up while the speaker is turned on.

③ **LINE1/2 volume controls**
Adjust the sound volume for each line input.

Note: For normal use, turn down the LINE2 volume completely, and turn up the LINE1 volume at the three o'clock position.

* Only for models supplied with the monitor speakers.

Basic Disklavier Terminology

The following is a list of several basic Disklavier words that you may need to know before proceeding with operational procedures in this manual. For additional Disklavier terminology, see the glossary provided in Chapter 15.

Ensemble Song

An ensemble song contains the same left- and right-hand parts as an L/R song, and extra tracks that are played by the internal XG tone generator. Accompanying tracks can include acoustic bass, drums, strings, vibes, etc.

Internal Flash Memory

The Disklavier has a total of 128 megabytes of internal flash memory that allow you to store song data without a floppy disk.

L/R Song

In a L/R song, the left-hand piano part is stored on track 1 (L) and the right-hand piano part is stored on track 2 (R). During playback you can cancel either part, and practice that part yourself. When recording an L/R song, you can record the two parts simultaneously or separately.

MIDI

An acronym for Musical Instrument Digital Interface. MIDI allows electronic musical instruments to communicate with each other.

PianoSoft



The PianoSoft Disk Collection is a library of prerecorded song disks made by Yamaha for use with the Disklavier series. Many titles are available, and among the many musical styles included are classical, jazz, and popular. The disk includes songs for listening enjoyment, piano study disks for the piano student, and accompaniment disks for vocal and instrumental practice. PianoSoft is sometimes used as a generic term for PianoSoft and PianoSoft-Plus.

PianoSoft-Plus



PianoSoft-Plus software contains prerecorded ensemble songs featuring instrumental accompaniment that can be played back on the Disklavier. See your Disklavier dealer for a PianoSoft catalog.

PianoSoft-PlusAudio



CD software made by Yamaha containing audio and MIDI signals for playing back on the Disklavier.

SmartPianoSoft



Software made by Yamaha containing MIDI signals for playing back along with standard audio CDs.

Song

A “song” usually means a short piece of music with lyrics. However, in the Disklavier manuals the term “song” is used to refer to any piece of music.

Tone Generator

An electronic device that generates instrument voices. The Disklavier has an internal XG tone generator that can produce nearly 700 instrumental and percussion voices.

Voice

The sounds produced by a tone generator expressing various instruments.

XG



Yamaha XG is an extension of the GM (General MIDI) format. With greater polyphony, more voice, and effects, it improves song compatibility between MIDI devices. When a song in the Yamaha XG format is played on another XG compatible tone generator or synthesizer, it will play and sound as the original composer/creator intended.

Connecting the Control Unit

Make sure that the cables extending from the piano is connected to the appropriate connectors or jacks on the rear panel of the control unit.

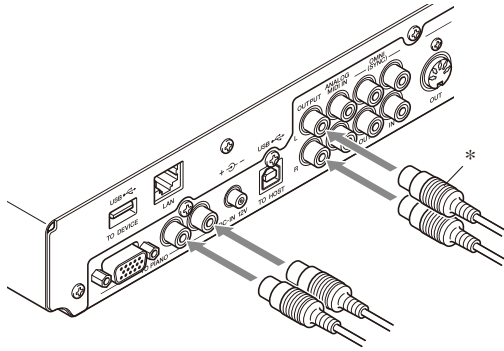

Note:

The cables should be connected to the control unit when the Disklavier is installed. If, however, it is not, carefully connect them to the appropriate connectors or jacks on the rear panel of the control unit.

Note:

For grand piano models, be sure to mount the control unit to the underside of the bass side key bed.

* Only for models supplied with the monitor speakers.

Connecting the AC Power Cable

- 1 Connect the power cord extending from the power supply unit of the piano to the DC-IN 12V connector of the control unit.

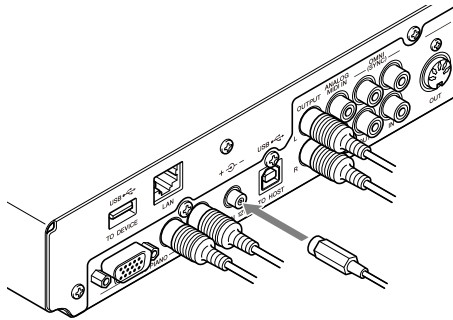

- 2 Connect the AC power cable extending from the piano to the AC wall outlet.

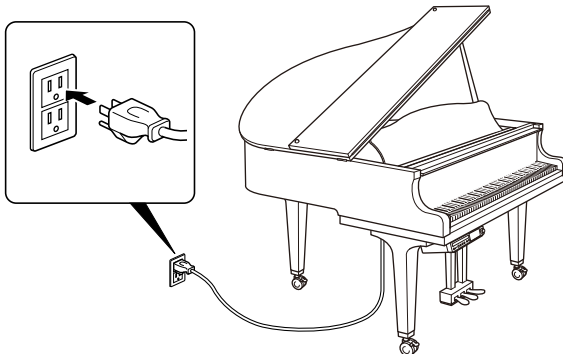

Important:

Make sure that the voltage of the AC wall outlet matches that marked on the Disklavier's Serial No. plate.

Using the Remote Control

The Disklavier is equipped with a remote control which allows convenient control from almost anywhere in the room. This chapter provides notes on handling the remote control.

■ Installing Batteries in the Remote Control

Before the remote control can be used, the two batteries supplied with the Disklavier must be installed.

Remove the battery cover from the rear of the remote control, install the batteries, and then replace the cover.

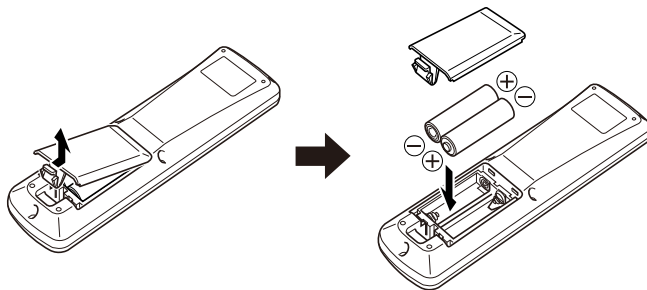

A diagram inside the battery compartment shows which way the batteries should be installed. Make sure you insert them correctly.

■ Battery Replacement

When the remote control fails to work from a distance, replace the batteries.

- Replacement batteries should be UM-3, AA, R6P, or LR6 type.
- Do not use new and old dry batteries together.
- Do not use different types of batteries (alkaline and manganese batteries, batteries made by different manufacturers or different battery products made by the same manufacturer) together.
- Remove spent batteries immediately from the remote control. Otherwise, batteries will overdischarge, causing them to leak electrolyte or burst which in turn may result in damage to nearby objects or in burns, injury or other bodily harm.
- Dispose of batteries in accordance with the applicable regulations and ordinances.
- If the remote control is not to be used for a prolonged period of time, remove the batteries to prevent possible damage by battery leakage.
- If the batteries have leaked, dispose of them immediately. Avoid touching the leaked electrolyte or letting it come into contact with skin or clothing. Clean the battery compartment thoroughly before installing new batteries.

Important:

Be sure to read the section on “Handling Batteries” on page iii for details on the safe handling of dry batteries.

Getting Started

■ Using the Remote Control

To use the remote control, point it at the remote control sensor on the control unit.

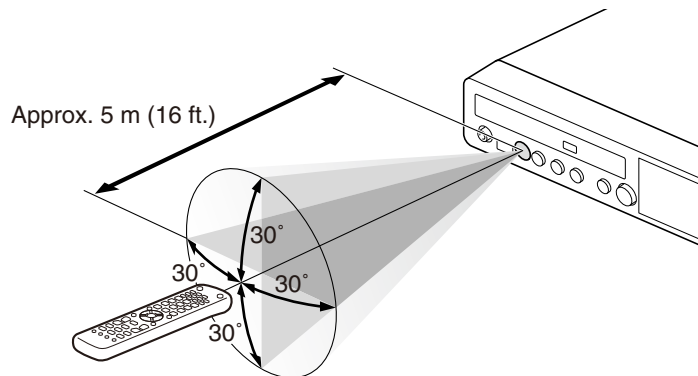

Turning On the Disklavier

- 1** Make sure that the main switch on the power supply unit is turned on.

(Grand piano)

Power supply unit
(located on the bottom)

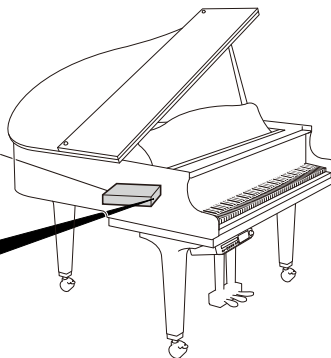
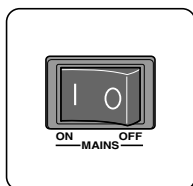

(Upright piano)

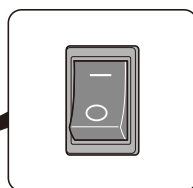
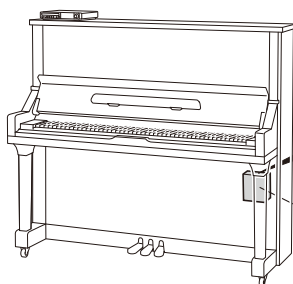

Power supply unit
(located on the rear)

2 Press [ON/OFF] on the control unit.



While the control unit is in the standby mode, you can also turn on the Disklavier by pressing [ON/STANDBY] on the remote control.

ON/STANDBY



The following message appears on the display, and [ON/OFF] on the control unit lights green.



After several seconds, the loading screen will appear, and last selected song will be loaded.



Your Disklavier is now ready for use.



See Chapter 2 “Getting Started – Turning Off the Disklavier (Standby Mode)” on page 14.

Setting the Internal Calendar

[SYSTEM] → “TimeZone” and “Clock Adj.”

The Disklavier has an internal calendar that can be set from 1/1/1985 00:00:00 to 12/31/2084 23:59:59. Set the calendar accurately so that the Disklavier displays the correct current time during the stop mode.

Time is displayed in 24-hour format.



Setting the correct time is also important for engaging timer-controlled programs. See Chapter 4 “Advanced Song Playback – Using the Timer Play” on page 35.

■ Time Zone

1 Press [SYSTEM] on the remote control.

The system menu screen appears.



Getting Started

- 2** Select “TimeZone” with the cursor buttons ([◀] [▶] [▲] [▼]), then press [ENTER].

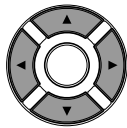

```
=SYSTEM MENU= (1/2)→
*Clock Adj. *TimeZone
*Backup *Restore
```

The time zone setup screen appears.

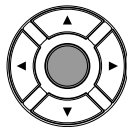

```
=Time Zone= --+ENT
TimeZone=GMT+0
```

- 3** Press [+ / YES] and [- / NO] to change the time zone.

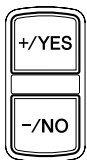

```
=Time Zone= --+ENT
TimeZone=GMT+2
```

Examples of Time Zone

The chart below shows the correspondence between the time zone setting on the Disklavier and actual time zone used in the U.S. and Canada.

Setting	Actual Time Zone
GMT-10	Hawaii-Aleutian Standard Time
GMT-9	Alaska Standard Time (AKST)
GMT-8	Alaska Daylight Time (AKDT)
	Pacific Standard Time (PST)
GMT-7	Pacific Daylight Time (PDT)
	Mountain Standard Time (MST)
GMT-6	Mountain Daylight Time (MDT)
	Central Standard Time (CST)
GMT-5	Central Daylight Time (CDT)
	Eastern Standard Time (EST)
GMT-4	Eastern Daylight Time (EDT)

- 4** Press [ENTER].

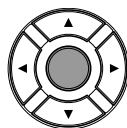

The time zone is set, and the display returns to the system menu. Proceed to the calendar setting.

Note:

The time zone listed here should be used only as a guide. For more details, contact your local observatories.

Calendar

- 1** Select “Clock Adj.” with the cursor buttons ([◀] [▶] [▲] [▼]), then press [ENTER].



The current date and time appear.



- 2** Press [ENTER].

The time setup screen appears with the cursor flashing on the hours display.



- 3** Select year, month, date, hours, minutes, and seconds with the cursor buttons ([◀] [▶]), then press [+ / YES] and [- / NO] to set a value.

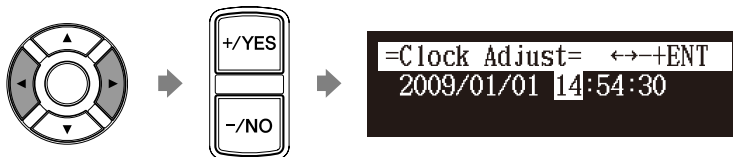

- 4** Press [ENTER].

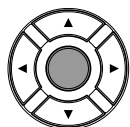

The date and time are stored in the internal calendar, and the display returns to the current time screen.

- 5** Press [BACK] on the remote control.



The display returns to the system menu screen.

Turning Off the Disklavier (Standby Mode)

Press [ON/STANDBY] on the remote control.

The ending screen appears, and [ON/OFF] on the control unit lights red.



Note:

Press [ON/STANDBY] on the remote control to turn the Disklavier back on.

Shutting Down the Disklavier

Press [ON/OFF] on the control unit.

The ending screen appears, and [ON/OFF] on the control unit turns off.

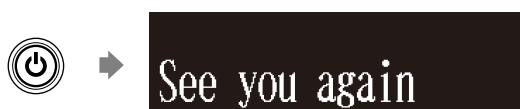

Note:

Be sure to wait 5 seconds before turning the Disklavier back on.

Compatible Media Format for the Removable Media

Compact Disc

The Disklavier can play songs on commercial audio CDs and data CDs (such as PianoSoft-PlusAudio).

- The audio CDs should be formatted in CD-DA.
- The data CDs should be formatted in ISO 9660 Level 1.

USB Flash Memory

You can use commercially available USB flash memories to store song data. The USB flash memory should be formatted in FAT16 or FAT32 file system.

USB Hard Disk

You can use commercially available USB hard disk drives to store song data or make a backup of song data. The USB hard disk drive should be formatted in FAT32 file system.

Floppy Disk (Optional)

With the optional USB floppy disk drive, you can use 3.5" 2DD or 2HD floppy disks to store song data. The floppy disk should be formatted in MS-DOS.

Note:

If the external medium contains a number of albums or songs, it may take some time for the Disklavier to recognize them.

Note:

Yamaha does not assure the operation of commercially available USB flash memories or USB hard disk drives. For a list of compatible products, please visit: www.yamaha.com/disklavier/

Note:

Do not insert or remove the USB media while reading or writing data. Make sure that reading or writing has finished before doing so.

Compatible File Format

The Disklavier can handle these three types of file format:

SMF0

Standard MIDI File format 0 for playback and recording. The name of the file should have an extension as “.MID” or “.mid.”

SMF1

Standard MIDI File format 1 for playback only. The name of the file should have an extension as “.MID” or “.mid.”

E-SEQ

Format developed by Yamaha, for playback only. The name of the file should have an extension as “.FIL” or “.fil.”

Basic Precautions for Using CDs

■ Handling CDs

In order to protect data stored on compact discs from damage or loss, handle them with care, and observe the following precautions.

- Do not touch the surface of a CD.
- Do not expose CDs to extreme temperatures or humidity. The working temperature range is between 4°C and 52°C (40°F and 125°F).
- Wipe CDs with a clean, dry cloth before playback.
- Remove the CD from the CD drive before turning off the Disklavier.

■ Loading a CD

- 1** Press the CD eject button on the control unit to open the CD tray.

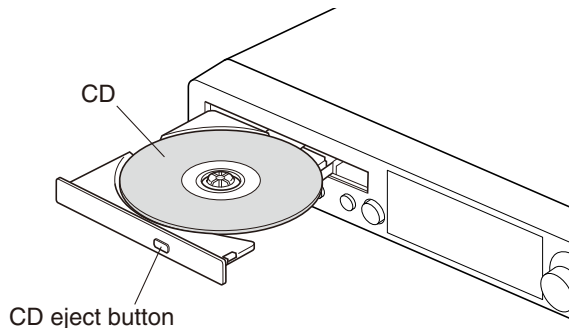

- 2** Place a CD on the tray, and then close the tray.

Types of Playable Software

PianoSoft and PianoSoft-Plus

When piano songs such as those contained in PianoSoft and PianoSoft-Plus software are played back on the Disklavier, the piano parts are actually played by the Disklavier keyboard, and the keys move up and down as though they were being played by an invisible performer. The ensemble parts (contained in PianoSoft-Plus software) are played by the internal tone generator and are heard from the monitor speakers*.



* Only for models supplied with the monitor speakers.

PianoSoft-PlusAudio

PianoSoft-PlusAudio songs are recorded using two channels, an analog MIDI channel for the piano parts and an audio channel for instrumentals and vocals. When they are played back on the Disklavier, the piano parts are played by the Disklavier keyboard as with PianoSoft and PianoSoft-Plus songs, and all other instrumental and vocal parts are heard from the monitor speakers* just like a normal stereo system.



SmartPianoSoft

SmartPianoSoft contains a recorded piano accompaniment to the commercial CDs, and the acoustic accompaniment will play back matching with the commercial CD. You can also record your own accompaniment for your favorite commercial CDs at home; play your Disklavier as you listen to a CD, and SmartPianoSoft will match the music together during playback, essentially adding you to famous performances.



Standard Audio CDs

Standard audio CDs contain two audio channels (L and R), and are both heard from the monitor speakers* just like a normal stereo system. In other words, the Disklavier can be used to play CDs in place of a stereo system.

Selecting Medium and Their Contents

[SELECT]

1 Insert a desired medium.

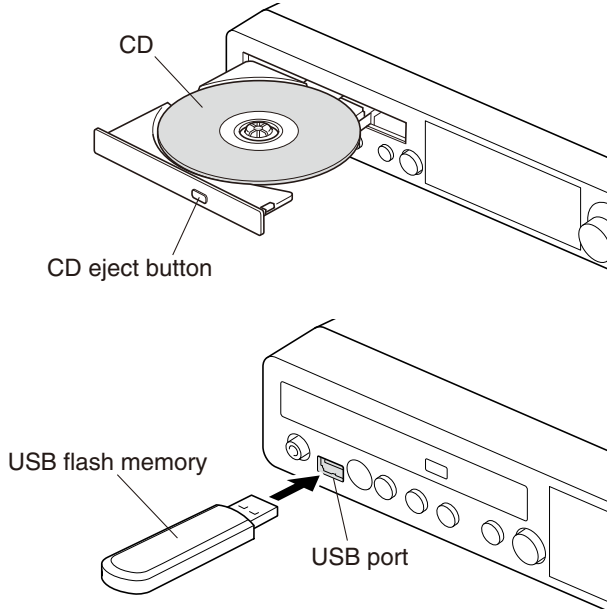

2 Press [SELECT].

The media selection screen appears with the current selected medium highlighted.



3 Select a desired medium with the cursor buttons ([◀] [▶]).



The following media are available:

Medium	Description
Memory	Internal flash memory
CD	Audio CD or data CD
USB1, USB2	USB flash memory or USB HDD (USB1 indicates the first inserted one, and USB2 indicates the second.)
Playlist	Playlist in the internal flash memory
D-Radio	DisklavierRadio
FromToPC	Network folder in the internal flash memory



See Chapter 3 “Basic Song Playback – Listening to the DisklavierRadio™” on page 25.



See Chapter 8 “Media Management – Copying Song File from a Personal Computer to the Disklavier” on page 84.

Basic Song Playback

4 Press [ENTER] or [▼].

The album selection screen appears.

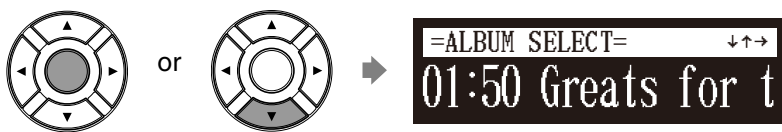
**5** Select a desired album with the cursor buttons ([◀] [▶]).

To return to the media selection screen, press [▲].

6 Press [ENTER] or [▼].

The song selection screen appears.

**7** Select a desired song with the cursor buttons ([◀] [▶]).

To return to the album selection screen, press [▲].

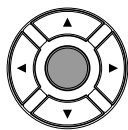
8 Press [ENTER].

The selected song is loaded.

Note:

The maximum number of the selectable albums in a medium is 99.

Note:

You can also select albums directly using the number keypad on the remote control. See Chapter 3 “Basic Song Playback – Using the Number Keypad” on page 19.

Note:

The maximum number of the selectable songs in an album is 999.

Note:

You can also select songs directly using the number keypad on the remote control. See Chapter 3 “Basic Song Playback – Using the Number Keypad” on page 19.

Using the Number Keypad

Album or song selection screen **Number button**

You can also select albums or songs directly with the number keypad on the remote control.

Press the corresponding number button, then press [ENTER].

For example, to select album number 5, first press [0], then [5], then [ENTER].



To select song number 36, first press [0], then [3], then [6], then [ENTER].



Note:

If you enter a number higher than the existed, the last album or song appears.

Starting Playback

[PLAY]

Press [PLAY/PAUSE] on the control unit or [PLAY] on the remote control.

[PLAY/PAUSE] on the control unit lights green, and the numerical value of the counter advances.

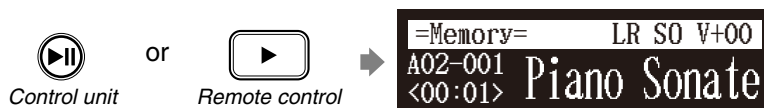

At the end of the song, the Disklavier selects the next song automatically and continues playback.

After playback the last song in the album, playback stops.

Basic Song Playback

■ Song Playback Screen

Here are a few things that you will often see during playback.

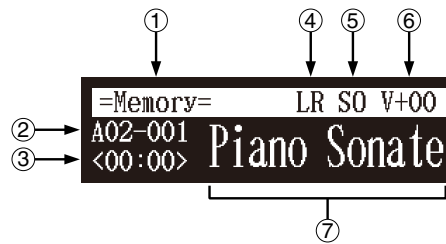

① Media

The selected medium is displayed here.

② Album/Song Number

The number of the selected album and song is displayed here.

Display	Description
Axx-yyy	xx: album number (01 to 99) yyy: song number (001 to 999)
Pxx-yyy	xx: playlist number (01 to 99) yyy: song number (001 to 999)

③ Counter

Playing time is indicated in one of two formats.

Display	Description
xx:yy	Minutes (xx) and seconds (yy)
xxx-y	Measures (xxx) and beats (y)

④ Song Type

The type of the selected songs is displayed here.

Display	Description
LR	PianoSoft
XP	PianoSoft recorded on the PRO model
PS	SmartPianoSoft
SK	SmartKey
YM	PianoSoft·PlusAudio
AU	Stereo audio

⑤ Song Format

The format of the selected song is displayed here.

Display	Description
S0	SMF (Standard MIDI File) format 0
S1	SMF (Standard MIDI File) format 1
ES	E-SEQ format

⑥ Volume

The current volume setting is displayed here.

⑦ Song Title

The title of the selected song is displayed here. If the title is long, it scrolls across the display.

Stopping Playback

During playback **[STOP]**

Press [STOP].

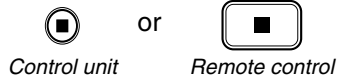

Playback stops, and the song returns to the beginning.

[PLAY/PAUSE] on the control unit turns off, and the counter is reset to "00:00" or "001-1."

Pausing Playback

During playback **[PAUSE]**

1 Press [PLAY/PAUSE] on the control unit, or [PAUSE] on the remote control.

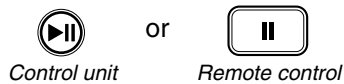

Playback pauses.

[PLAY/PAUSE] on the control unit flashes, and the counter stops counting.

2 Press [PLAY/PAUSE] on the control unit or [PLAY] on the remote control to continue playback.

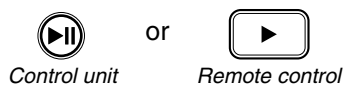

Fast Preview & Review

During playback **[FORWARD] or [REVERSE]**

During playback, fast preview and review allow you to quickly search through a song **while listening to the sound**. This is useful for locating a desired position within a song.

Note:

No sound is produced by the piano when fast-previewing or reviewing PianoSoft-PlusAudio CDs.

Fast Preview

- 1 To preview, hold [▶] on the control unit or press [FORWARD] on the remote control.

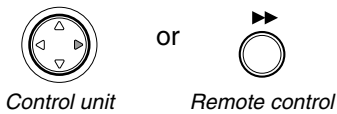

- 2 Release [▶] on the control unit, or press [FORWARD] on the remote control again to return to normal playback.

If a song is previewed all the way to the end, it will be paused at the end of the song.

Fast Review

- 1 To review, hold [◀] on the control unit or press [REVERSE] on the remote control.

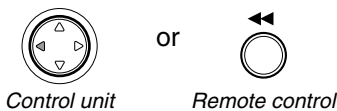

- 2 Release [◀] on the control unit, or press [REVERSE] on the remote control again to return to normal playback.

If a song is reviewed all the way to the beginning, it will be paused at the beginning of the song.

Fast Forward & Reverse

Stop or pause mode **[FORWARD] or [REVERSE]**

In the stop or pause mode, fast forward and reverse allow you to quickly locate a desired position in a song.

Reverse can also be used to return a song to the beginning, ready to play again.

■ Fast Forward

- 1** In the stop or pause mode, hold [▶] on the control unit or press [FORWARD] on the remote control.

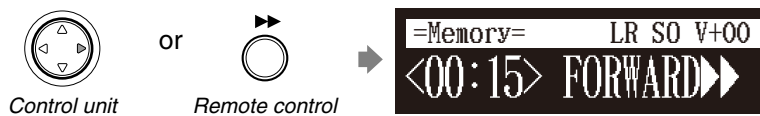

[PLAY/PAUSE] on the control unit flashes quickly and the counter shows the current position.

- 2** Release [▶] on the control unit, or press [FORWARD] on the remote control again to return to the pause mode.

If you fast forward a song all the way to the end, it will be paused at the end of the song.

■ Fast Reverse

- 1** In the pause mode, hold [◀] on the control unit or press [REVERSE] on the remote control.

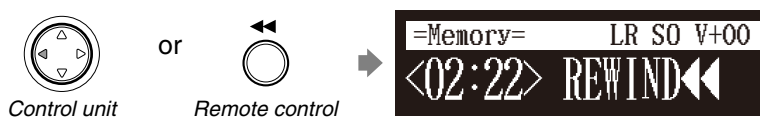

[PLAY/PAUSE] on the control unit flashes quickly and the counter shows the current position.

- 2** Release [◀] on the control unit, or press [REVERSE] on the remote control again to return to the pause mode.

If you reverse a song all the way to the beginning, it will be paused at the beginning of the song.

Searching a Specific Section of a Song

During playback or stop/pause mode **[SEARCH]**

Playback can be started from a specified point in a song. Instead of using fast forward or preview, you can use this function to go directly to a desired point within a song.

If the current song uses the minutes and seconds time format, you specify the point in minutes and seconds. If it uses the measures and beats time format, you specify the point in measures and beats.

1 Press [SEARCH] on the remote control.

The song search screen appears with the counter flashing.

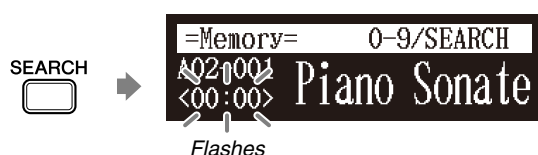

The song will be paused at the exact point as you press [SEARCH].

2 Enter the time that you want to search for with the number keypad.

For example, to search for 2:56 (minutes and seconds), first press [0], then [2], [5], and [6].



For example, to search for 52-3 (measures and beats), first press [0], then [5], [2], and [3].



3 Press [SEARCH] again.



The position of the song goes to the specified point.

Note:

If you enter a value higher than the entire song time, the search goes to the end of the song.

Listening to the DisklavierRadio™

Media selection screen "D-Radio"

You can listen to streaming broadcasts of music, with many channels of music contents.

1 Select "D-Radio" in the media selection screen.

The channel selection screen appears.



2 Press [◀] or [▶] or [+ / YES] or [- / NO] to select a channel.

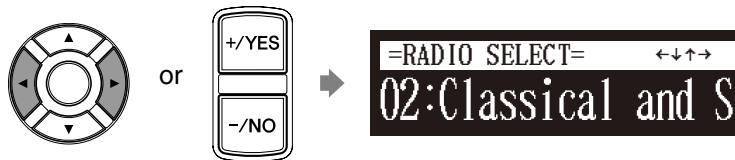

3 Press [ENTER] or [▼] to begin the broadcast of the selected channel.

The DisklavierRadio screen appears.

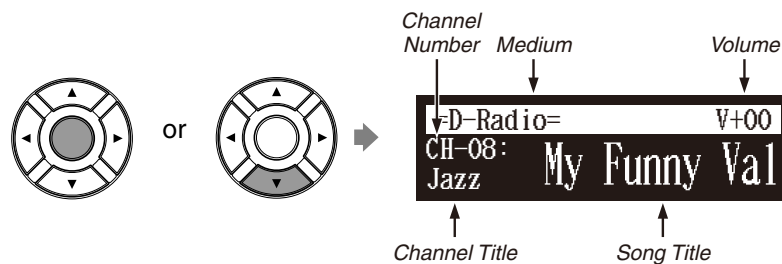

4 Press [▲] twice to stop the broadcast and return to the media selection screen.

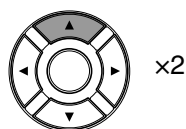

To enjoy the DisklavierRadio, first you need to connect to the Internet. See Chapter 9 "Internet Direct Connection (IDC) – Connecting the Disklavier to the Internet" on page 93.



To select a medium, see Chapter 3 "Basic Song Playback – Selecting Medium and Their Contents" on page 17.

Basic Song Playback

■ Muting the Sound

1 Press [PAUSE] or [STOP].

“MUTE” appears on the upper right of the screen.



2 Press [PAUSE] or [STOP] again to release muting.

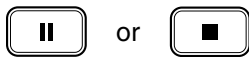

Note:

Streaming broadcasts continue during muting. Therefore, the song broadcasted when releasing muting may differ from the one when muting.

Adjusting the Volume

[VOLUME +] or [VOLUME -]

You can adjust volume with the control unit or with the remote control as described below. Since all piano songs are recorded at the maximum volume level of 0, volume can be decreased down to -10, the softest volume at which the piano can play.

For ensemble songs, the volume of the piano and internal XG tone generator are adjusted simultaneously, so it is a good idea to first balance the volume of the piano and XG tone generator.

For songs on PianoSoft-PlusAudio, you should first balance the volume of the MIDI piano and audio parts.

Note:

This setting does not affect manual playing.



See Chapter 4 “Advanced Song Playback – Adjusting the Volume Balance among the Keyboard Playing, Ensemble Sound, and Software Playback” on page 31.

1 Press [VOLUME +] or [VOLUME -] on the remote control.

The main volume setting screen appears.



2 Press [VOLUME +] or [VOLUME -] to adjust the volume.

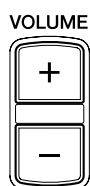

Volume can be adjusted in a range of -10 to 0.

Note:

You can also use the dial on the control unit to adjust the volume.

Note:

When the volume is set to -10, there may be a slight delay in sound production following key strokes, and the Disklavier may skip some notes. Furthermore, at this volume setting, touch strength does not affect note dynamics.

Changing the Playback Tempo

[TEMPO -] or [TEMPO +]

You can speed up or slow down the playback tempo. Slowing down the playback tempo can be useful when practicing a difficult piano part.

These tempo settings remain in effect until recording is started, another medium or album is selected, or the Disklavier is turned off.

1 Press [TEMPO -] or [TEMPO +] on the remote control.

The tempo setting screen appears.



2 Press [TEMPO -] or [TEMPO +] to adjust the tempo.



Playback tempo can be adjusted from -50% to +50% in 1% increments.

Press [TEMPO 0] to set to the original tempo.

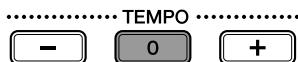

Note:

You cannot change the playback tempo of songs on audio CDs.



Tempo changes to songs that you have recorded yourself can be made permanent. See Chapter 7 “Advanced Recording – Changing the Default Tempo” on page 55.

Note:

You can also use the dial on the control unit to adjust the tempo.

Playing Back Songs in a Different Key (Transposition)

[TRANSCOPE -] or [TRANSCOPE +]

Playback can be transposed up or down by up to two octaves. This is useful, for example, when you want to sing along (karaoke) in a different key from the original recording.

Transposition changes remain in effect until recording is started, another medium or album is selected, or the Disklavier is turned off.

Note:

This function cannot be used to transpose songs from external devices connected to the OMNI IN jacks, or on audio CDs.

Advanced Song Playback

- 1 Press [TRANSPPOSE -] or [TRANSPPOSE +] on the remote control.

The transposition setting screen appears.



- 2 Press [TRANSPPOSE -] or [TRANSPPOSE +] to change the key.



Playback can be transposed in half-step increments up or down two octaves (-24 key to +24 key)

Press [TRANSPPOSE 0] to set to the original key.

**Note:**

You can also use the dial on the control unit to adjust the key.

Repeating Song Playback

[REPEAT]

There are three repeat modes (ALL, RPT, RND) as described below. You can use these functions for entertainment or study purpose.

Repeat mode settings remain in effect until recording is started, another medium or album is selected, or the Disklavier is tuned off.

- 1 Press [REPEAT] on the remote control.

The repeat setting screen appears.



- 2 Press [REPEAT] to select repeat modes.



The following options are available:

Option	Description
ALL	Repeats all songs on the selected album.
RPT	Repeats selected song.
RND	Shuffles the order of songs on the selected album and repeats the cycle.
OFF	Plays back songs normally.

- 3** Press [PLAY] to start repeat playback.



- 4** To cancel the repeat mode, press [REPEAT] until “OFF” appears on the screen.



Repeating a Specific Section of a Song (A-B Repeat)

During playback **[A-B]**

In the A-B repeat, playback is repeated between two specified points in a song: point A and point B. This function is useful when practicing or memorizing a difficult section of a song.

Once specified, points A and B are saved until another song is selected, recording is started, or the Disklavier is turned off.

- 1** To set point A, play back a song and press [A-B] on the remote control when the desired point is reached.

Point A is set.

The A-B repeat setting screen appears with the “B” flashing.



- 2** To set point B, press [A-B] again.

Point B is set.

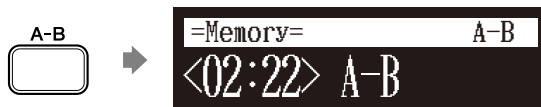

Playback starts from point A, continues up to point B and, returns to point A and playback starts repeatedly.

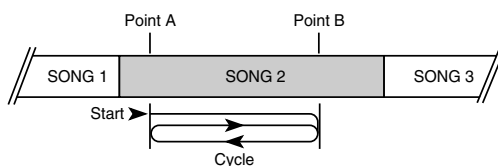

Note:

You cannot set point B that is beyond the selected song.

Advanced Song Playback

- 3** To cancel the A-B repeat, press [A-B] so that “OFF” flashes on the screen.



Pressing [BACK] also cancels the point setting, and returns to the song playback screen.

Note:

The A-B repeat is cancelled if you escape from the A-B repeat setting screen by other operations.

Playing Back Only the Desired Piano Part

[PART SELECT L] or [PART SELECT R]

This could be useful, for example, when listening carefully to one part, and also when you practice only the left- or right-hand part while the Disklavier plays the other.

■ Cancelling the Piano Part

- 1** Select the desired song.
- 2** Press [PART SELECT L] or [PART SELECT R] on the remote control to cancel a part.

The part cancellation screen appears with the corresponding part canceled.



Notes of displays:

Display	Description
L	Left hand part
R	Right hand part
P	Pedal part
ON	Plays part
OFF	Cancels part
G	Plays part with guide (only for SmartKey song)
---	No plays on part

- 3** To replay the cancelled part, press [PART SELECT L] or [PART SELECT R] again so that “ON” appears on the screen.



- 4** Press [BACK] to return to the song playback screen.



To select a song, see Chapter 3 “Basic Song Playback – Selecting Medium and Their Contents” on page 17.

Note:

For the SmartKey song, “ON”, “OFF” and “G” appear sequentially each time you press [PART SELECT L] or [PART SELECT R].

■ Cancelling the Pedal Part

- 1** On the part cancellation screen, press [▶] to select “P=.”



- 2** Press [-/NO] to cancel a pedal part.



- 3** To replay the pedal part, press [+ /YES] with the cursor is on “P=.”



- 4** Press [BACK] to return to the song playback screen.



Adjusting the Volume Balance among the Keyboard Playing, Ensemble Sound, and Software Playback

[BALANCE]

Besides adjusting the overall volume, the volume balance among the different sound sources as described below can be adjustable.

- TG:** Adjusts the volume of the ensemble sound reproduced by the tone generator (TG) of the Disklavier.
- Audio:** Adjusts the volume of the accompaniment or standard audio sound pre-recorded in the software (CDs).
- Voice:** Adjusts the volume of the ensemble voice when you play using the voice function.

Note:

You cannot adjust the volume balance during the DisklavierRadio playback.



See Chapter 5 “Advanced Piano Playing – Playing the Disklavier with an Ensemble Voice” on page 43.

■ Adjusting the TG Balance

- 1 Press [BALANCE] on the remote control.

The TG balance setting screen appears.



- 2 Press [+ / YES] and [- / NO] to adjust the volume of the tone generator.

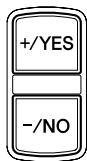

Tone generator volume can be adjusted in a range of 10 to 127.

Note:

You can also use the dial on the control unit to adjust the volume.

■ Adjusting the Audio Balance

- 1 Press [BALANCE] twice on the remote control.

The audio balance setting screen appears.



- 2 Press [+ / YES] and [- / NO] to adjust the volume of the audio.

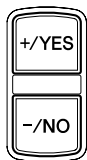

Audio volume can be adjusted in a range of 10 to 127.

Note:

You can also use the dial on the control unit to adjust the volume.

■ Adjusting the Voice Balance

- 1 Press [BALANCE] three times on the remote control.

The voice balance setting screen appears.



- 2 Press [+ / YES] and [- / NO] to adjust the volume of the voice.

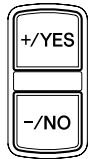

Voice volume can be adjusted in a range of 0 to 127.

Note:

You can also use the dial on the control unit to adjust the volume.

Adjusting the Pitch of Audio

During playback **[FUNC.]**

You can temporarily adjust the pitch of the song contains audio (PianoSoft·PlusAudio, SmartPianoSoft) or an audio CD for your listening pleasure.

Pitch adjustments are effective until another medium or album is selected, recording is started, or the Disklavier is turned off.

Note:

This function cannot be used to adjust the pitch of external audio CDs connected to the OMNI IN jacks.

- 1 During the song playback, press [FUNC.] on the remote control.

The audio pitch setting screen appears.



- 2 Press [+ / YES] and [- / NO] to change the audio pitch.



Audio pitch can be adjusted in a range of -50 cent to +50 cent (one semitone as 100 cents).

Adjusting the L/R Balance of Audio

During playback **[FUNC.]**

You can temporarily adjust the L/R balance of an audio CD.

Balance adjustments are effective until another song is selected, recording is started, or the Disklavier is turned off.

1 During the song playback, press [FUNC.] several times.

The audio pan setting screen appears.



2 Press [+ / YES] and [- / NO] to change the audio pan.



The following pan settings are available:

Option	Description
Left	Audio of the L channel is output to both of the L and R channels.
Center	Audio of the L channel is output to the L channel, and the R channel is output to the R channel.
Right	Audio of the R channel is output to both of the L and R channels.

Using the Timer Play

[SETUP] → "TimerPlay"

You can program your Disklavier to start or stop playback of a song at various specified times. All you need to do is register up to a maximum of 99 timer settings, and your Disklavier will perform them unattended. This function is called "timer play."

The following describes how to play back the first album in the internal flash memory at 8:15 AM.

1 Press [SETUP] on the remote control.

The setup menu screen appears.



2 Select "TimerPlay" with the cursor buttons ([◀][▶][▲][▼]), then press [ENTER].



The timer play setting screen appears.

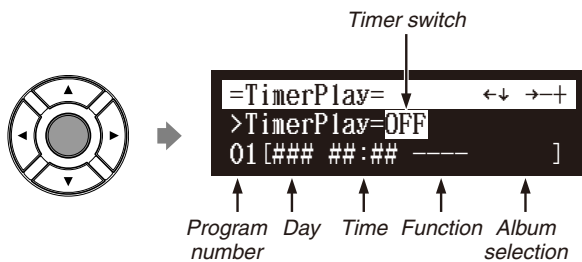

3 Confirm that the cursor is on the timer switch, then press [+ / YES] and [- / NO] to switch the timer play on and off.

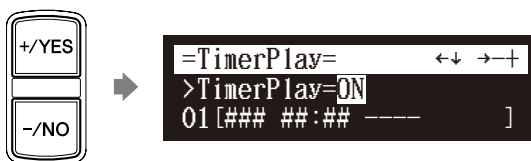

Note:

The internal calendar must be set in advance in order for the timer play to function. See Chapter 2 "Getting Started – Setting the Internal Calendar" on page 11.

Note:

The control unit must be turned on in advance in order for the timer play to function. The timer play cannot turn on/off the control unit.

Advanced Song Playback

- 4** Press [▲] and [▼] to select the desired program number.

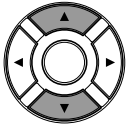

The cursor moves to the function parameter.

- 5** Press [◀] and [▶] to move the cursor to the function parameter, then press [+ / YES] and [- / NO] to select the desired function.



The following functions are available:

PLAY	Starts playback of songs.
STOP	Stops playback of songs.
RND	Starts playback of songs at random.
OFF	Turns off the Disklavier (standby mode).

When “PLAY” or “RND” is selected, the album selection parameter appears.

- 6** Press [▶] to move the cursor to the album selection parameter, then press [+ / YES] and [- / NO] to select the desired album.



The following selections are available:

Mem01 - Mem99	Albums (01 - 99) in the internal flash memory.
Lst01 - Lst99	Playlists (01 - 99) created in the internal flash memory.
Radio	The last DisklavierRadio channel you have listened to.
-----	Current selected song.

Note:

You cannot select “Radio” if you select “RND” in step 5.

Note:

When “Radio” is selected, the Disklavier will connect to the Internet one minute prior to the time you have set, and the channel selection screen appears. DisklavierRadio will begin to play at the designated time.

- 7** Press [◀] to move the cursor to the day parameter, then press [+ / YES] and [- / NO] to select the desired day.

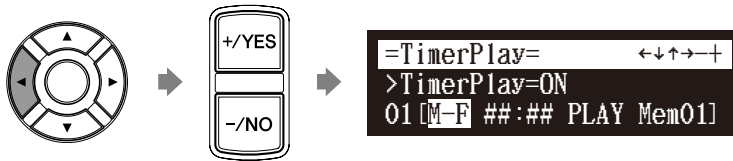

The following day settings are available:

ALL	The timer play functions on every day of the week.
MON	The timer play functions only on Monday.
TUE	The timer play functions only on Tuesday.
WED	The timer play functions only on Wednesday.
THU	The timer play functions only on Thursday.
FRI	The timer play functions only on Friday.
SAT	The timer play functions only on Saturday.
SUN	The timer play functions only on Sunday.
M-F	The timer play functions on Monday thru Friday.
M-S	The timer play functions on Monday thru Saturday.

- 8** Press [▶] to move the cursor to the hour parameter, then press [+ / YES] and [- / NO] to set hours.

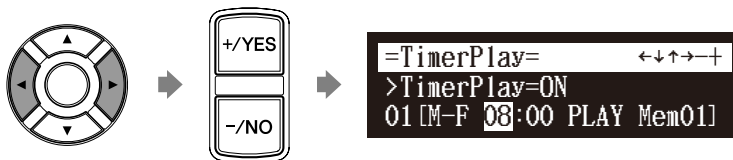

- 9** Press [▶] to move the cursor to the minute parameter, then press [+ / YES] and [- / NO] to set minutes.



- 10** Press [ENTER] to return to the setup menu screen.

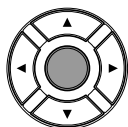

■ About Song Playback Screen

When the song playback is stopped — with the timer play function is set to ON and the current time is displayed — “T” flashes to the right side of the current time.



↑
Indicates that the timer play is on.

Skipping the Blank Part at the Beginning of a Song

[SETUP] → "Playback"

When there is a blank part created at the beginning of the recorded song, turning on this function automatically skips the unwanted part and starts playback from the actual beginning of the song.

1 Press [SETUP] on the remote control.

The setup menu screen appears.



2 Select "Playback" with the cursor buttons ([◀][▶][▲][▼]), then press [ENTER].



The playback setting screen appears with the cursor flashing.



3 Press [+ / YES] and [- / NO] to change setting.



- 4** Press [ENTER] to return to the setup menu screen.



Video Synchronized Playback

You can enjoy piano playback with the video recorded on the DVD recorder.

- 1** Perform the video synchronized recording in advance.
- 2** Make sure that the OMNI IN setting is set to “AutoDetect”.
- 3** Turn down the volume completely on the TV if you connect the audio output of the DVD recorder to the TV.
Turn down the volume completely on the camcorder if you use the camcorder only.
- 4** Start playback on the DVD recorder.

Start playback on the camcorder if you use the camcorder only.

The Disklavier automatically searches and selects the song paired with the video, and then starts playback as well.

```
=Memory= (SYNC) S0 V+00
A01-005 PIAN0005.MID
<00:03>
```

If the piano playing is not synchronized with the video

Adjust the offset time for synchronization. See Chapter 10 “Enhancing the Disklavier by Hooking Up Other Devices – Setting the Disklavier for Audio Data Reception/Transmission” on page 102.

If noises (synchronized signal) are heard during playback

Turn down the signal level and re-record. See Chapter 10 “Enhancing the Disklavier by Hooking Up Other Devices – Setting the Disklavier for Audio Data Reception/Transmission” on page 102.



For details on video synchronized recording, see Chapter 7 “Advanced Recording – Video Synchronized Recording” on page 57.

Note:

Be sure to rewind the video cassette to locate the beginning of the recording. It may take some time before piano playback starts if you start playback halfway through the video.

Note:

When using the song copied to the USB flash memory, it may take some time until the Disklavier recognizes the information for synchronization.



See “Setting for Video Synchronized Recording” on page 57.

Note:

When searching for songs for video synchronized playback from a USB flash memory, you can search from a maximum of 150 songs per USB flash memory. It is therefore recommended that you copy songs for video synchronized playback onto the internal memory. When saving onto a USB flash memory, it is recommended that you do not exceed a total of 150 saved songs per memory.

Note:

You cannot operate the Disklavier using the control unit or remote control during video synchronized playback. If you want to stop playback of the song, stop playback on the DVD recorder (or the camcorder).

Adding Disklavier Accompaniment to Commercial CD Songs (PianoSmart™ Playback)

Insert a CD → Select a SmartPianoSoft song → [PLAY]

You can add a Disklavier piano performance you recorded or on commercially available SmartPianoSoft software to the playback of songs on your favorite CDs.

1 Insert a desired CD that you want to synchronize with the SmartPianoSoft song.

2 Select a desired SmartPianoSoft song.

3 Press [PLAY].

Playback begins with the CD playback.



To record the piano performance to add, see Chapter 7 “Advanced Recording – CD Synchronized Recording” on page 61.



To select a song, see Chapter 3 “Basic Song Playback – Selecting Medium and Their Contents” on page 17.

SmartKey™ Playback

Select a SmartKey song → [PLAY]

Special SmartKey software uses all the “SmartKey” features to create an exciting way in which non-players can learn to play simple melodies, one note at a time, without the need for written music. SmartKey software does this by partially depressing the piano key to signal which note should be played. The Disklavier then waits for you to press this key before it continues to the next note in the melody (If you miss the movement of the key, the Disklavier will repeat the movement until you press the key). When you press the key, the Disklavier will reward you with ear tickling phrases, incredible harmonies, and lush arpeggios to give you the aural and visual image of a complete high-quality performance. In short, it SHOWS you which key to play, WAITS for you to play that key before it continues, and REWARDS you with music. It is like having an eternally patient music teacher showing your fingers which notes to play.

1 Select a desired SmartKey song.



To cancel the SmartKey playback, see Chapter 4 “Advanced Song Playback – Playing Back Only the Desired Piano Part” on page 30.



To select a song, see Chapter 3 “Basic Song Playback – Selecting Medium and Their Contents” on page 17.

2 Press [PLAY].



Playback stops, and the key to play next moves slightly.

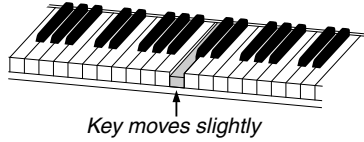

The key to play flashes in the counter.



3 Play the key that the keyboard indicates.

This will continue until the song is finished. Notice that the Disklavier patiently waits for you to play the right key before proceeding to the next key. Also, notice that if you happen to miss the cue, it will gently remind you what the key is every few seconds until you play the right key.

Key Notation

As a reference, "C3" is middle "C", which means "C4" is an octave above middle "C" and so on.

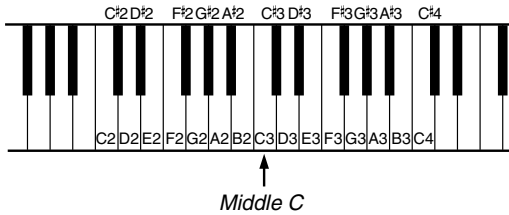

Playing the Disklavier along with the Internal Metronome

[METRONOME]

The internal metronome helps you playing along the meter (beat) and the tempo you set. Also the volume of the metronome can be adjusted.

1 Press [METRONOME] on the remote control.

The metronome setting screen appears and the metronome starts to click.



2 To change the tempo, move the cursor to the tempo parameter ("TEMPO") with the cursor buttons ([<] [>] [▲] [▼]), then press [+ / YES] and [- / NO].

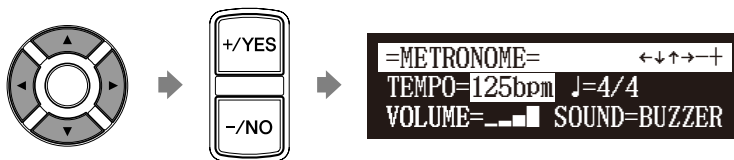

The tempo can be adjusted in a range of 30 bpm to 400 bpm.

3 To change the beat, move the cursor to the beat parameter ("J") with the cursor buttons ([<] [>] [▲] [▼]), then press [+ / YES] and [- / NO].

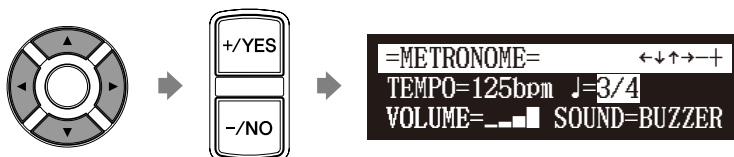

The following beat settings are available: 1/4, 2/4, 3/4, 4/4, 5/4, 6/4, 7/4, 8/4, 9/4.

Note:

The tempo parameter displayed on the metronome setting screen indicates the number of beats in a minute, and one beat represents a quarter. When you play a song written in different measure unit from quarter note, change the setting (e.g. When playing a song in 3/2, set beat to 6/4).

- 4** To change the volume, move the cursor to the volume parameter (“VOLUME”) with the cursor buttons ([◀] [▶] [▲] [▼]), then press [+ / YES] and [- / NO].

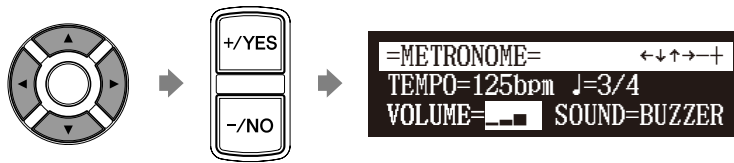

The volume can be adjusted in 4 steps.

- 5** To change the sound, move the cursor to the sound parameter (“SOUND”) with the cursor buttons ([◀] [▶] [▲] [▼]), then press [+ / YES] and [- / NO].

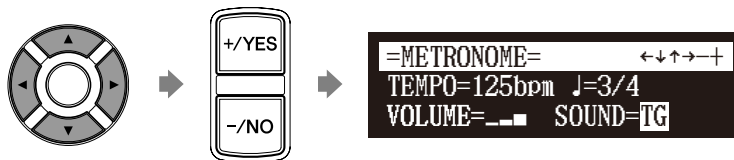

The following sound settings are available: BUZZER, TG

- 6** To cancel this function, press [METRONOME] again.



Playing the Disklavier with an Ensemble Voice

[VOICE]

The Disklavier’s [VOICE] lets you assign a voice from the internal XG tone generator to accompany the piano while you play. You will hear in unison the piano sound coming from the Disklavier and an ensemble voice produced by the internal XG tone generator. This is sometimes referred to as voice layering or unison.

The internal XG tone generator offers 480 instrumental voices and 11 drum kits for playing the keyboard.

- 1** Press [VOICE] on the remote control.

The voice selection screen appears, and the voice function is activated.

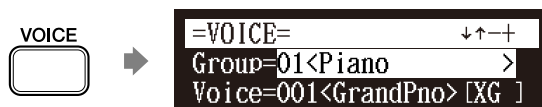

For details on voice groups and voices, see Chapter 12 “Internal Tone Generator Voices” on page 123.

Advanced Piano Playing

2 Press [+ / YES] and [- / NO] to select a voice group.

Changing the voice group displays the top voice of that group in the voice parameters.

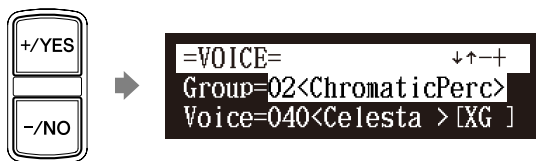
**3** To change the voice, press [▼] to move the cursor to the voice parameter (“Voice”), then press [+ / YES] and [- / NO].

If necessary, adjust the volume of the voice in the voice balance setting screen.

4 To inactivate this function, press [VOICE] again.

See Chapter 4 “Advanced Song Playback – Adjusting the Volume Balance among the Keyboard Playing, Ensemble Sound, and Software Playback” on page 31.

Note:

The voice function is inactivated if you escape from the voice selection screen by other operations.

Basic Recording

A song that you play on the Disklavier can be recorded and the recorded song can be easily saved for the selected medium. Furthermore, you can title your new recording for simple distinguish before recording.

Recording a New Song

[RECORD]

You can save a new song that you play for an album.

1 Select a destination medium and album.

2 Press [RECORD].

The recording standby screen appears, and [RECORD] on the control unit lights red and [PLAY/PAUSE] flashes in green.

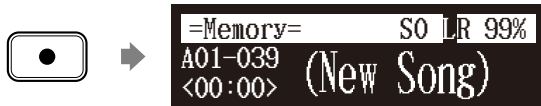

The level appears in the format section as soon as you play a keyboard or press a pedal.

3 Press [PLAY].



[PLAY/PAUSE] stops flashing.
The Disklavier is now ready for you to play.

4 Start playing your song.

Recording will start automatically as soon as you touch a key. The counter starts to advance.



5 Press [STOP] when you finish playing your song.



The recorded song is loaded.

Note:

Up to 999 songs can be recorded in a medium.



To select a medium and album, see Chapter 3 “Basic Song Playback – Selecting Medium and Their Contents” on page 17.

Note:

You cannot select “CD” as the destination medium.

Titling a Song at the Start of Recording

[RECORD] [FUNC.]x2

Title a new song before you start recording.

1 Select a destination medium and album.



To select a medium and album, see Chapter 3 “Basic Song Playback – Selecting Medium and Their Contents” on page 17.

2 Press [RECORD].



To rename the existing song, see Chapter 8 “Media Management – Renaming a Song” on page 71.

3 Press [FUNC.] twice in the recording standby screen.

The song title editing screen appears.



4 Enter a title to a new song.



You can enter up to 64 characters.
Follow the instructions in “Entering Characters” on next page.

5 Press [PLAY] after title determined.



Recording begins.

■ Entering Characters

How to Enter Characters with the Remote Control

The following illustration shows how to enter characters with the remote control.

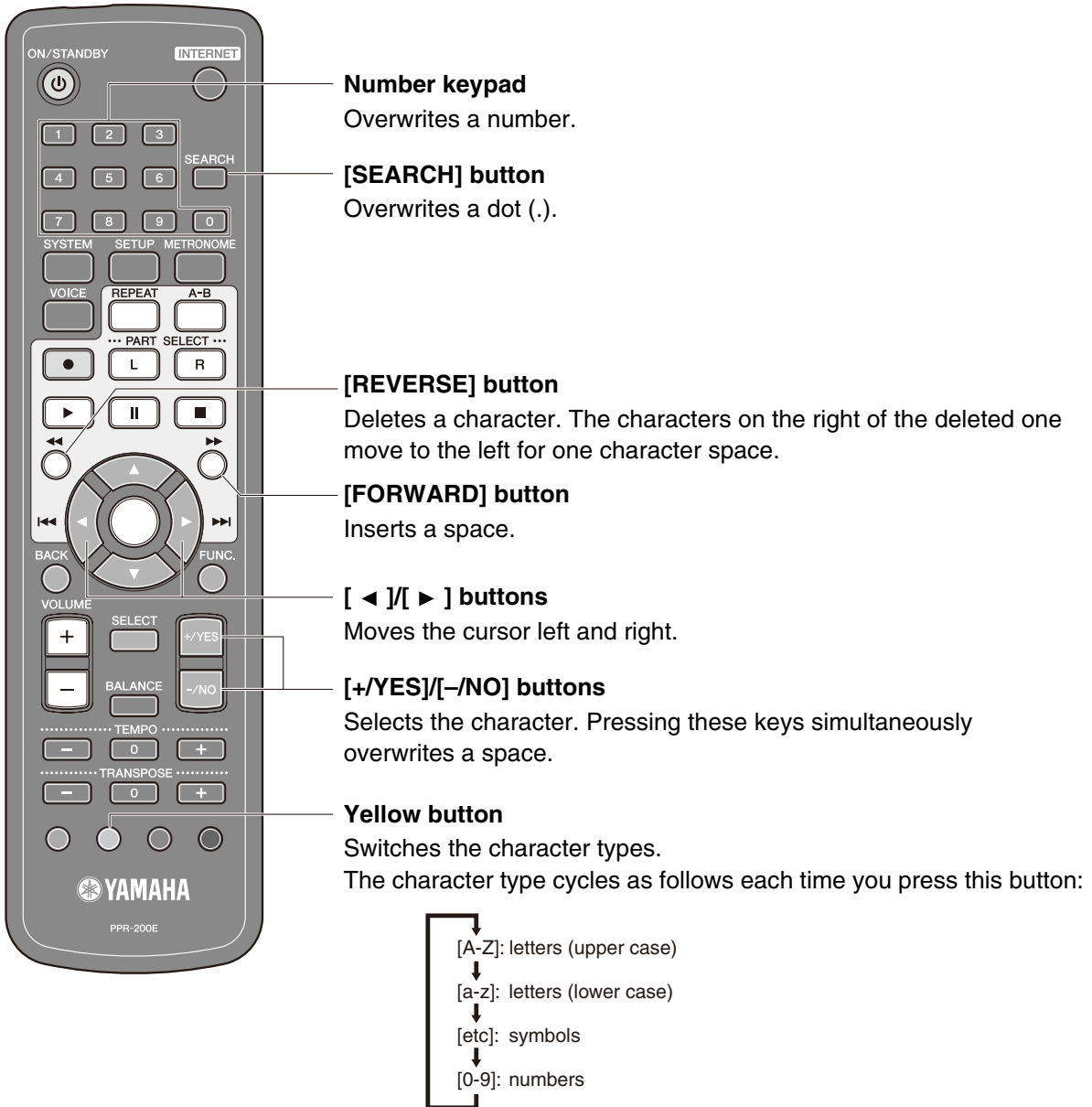

Available Characters

The following table shows which characters are available.

Character Type	Characters															
Letters (Upper Case) [A-Z]	Space	A	B	C	D	E	F	G	H	I	J	K	L			
	M	N	O	P	Q	R	S	T	U	V	W	X	Y	Z		
Letters (Lower Case) [a-z]	Space	a	b	c	d	e	f	g	h	i	j	k	l			
	m	n	o	p	q	r	s	t	u	v	w	x	y	z		
Symbols [etc]	Space	!	”	#	\$	%	&	'	()	*	+	,			
	-	.	/	:	;	<	=	>	?	_	@					
Numbers [0-9]	Space	0	1	2	3	4	5	6	7	8	9					

Advanced Recording

This chapter describes further functions for the advanced piano recording such as playing and measuring the current playing song tempo with the metronome, recording the left-hand part and the right-hand part separately.

Recording with the Internal Metronome

[METRONOME] [RECORD]

You can use the metronome to record songs.

Songs recorded with the metronome will be in the measures and beats format.

All metronome parameters are reset when the Disklavier is switched off.

1 Press [METRONOME] on the remote control.

The metronome setting screen appears.



2 To change the tempo, move the cursor to the tempo parameter (“TEMPO”) with the cursor buttons ([◀] [▶] [▲] [▼]), then press [+ / YES] and [- / NO].

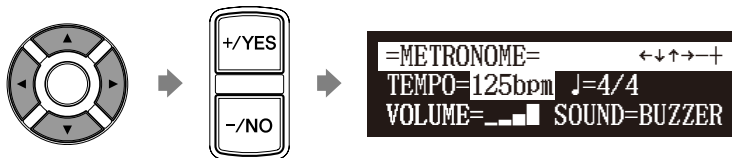

The tempo can be adjusted in a range of 30 bpm to 400 bpm.

3 To change the beat, move the cursor to the beat parameter (“J”) with the cursor buttons ([◀] [▶] [▲] [▼]), then press [+ / YES] and [- / NO].

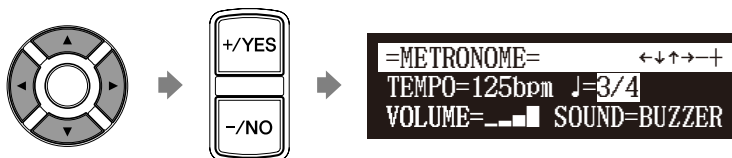

The following beat settings are available: 1/4, 2/4, 3/4, 4/4, 5/4, 6/4, 7/4, 8/4, 9/4.

Note:

The tempo parameter displayed on the metronome setting screen indicates the number of beats in a minute, and one beat represents a quarter. When you play a song written in different measure unit from quarter note, change the setting (e.g. When playing a song in 3/2, set beat to 6/4).

- 4** To change the volume, move the cursor to the volume parameter (“VOLUME”) with the cursor buttons ([◀] [▶] [▲] [▼]), then press [+ / YES] and [- / NO].

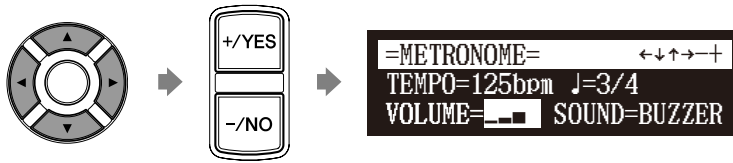

The volume can be adjusted in 4 steps.

- 5** To change the sound, move the cursor to the sound parameter (“SOUND”) with the cursor buttons ([◀] [▶] [▲] [▼]), then press [+ / YES] and [- / NO].

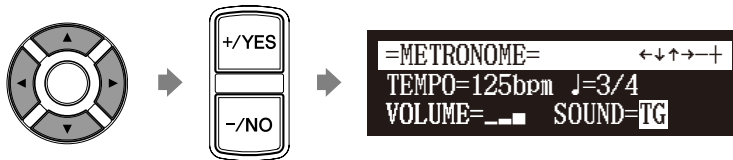

The following sound settings are available: BUZZER, TG

- 6** Press [RECORD] in the metronome setting screen.

The metronome recording setting screen appears.



- 7** Press [PLAY]



Recording begins immediately.

[PLAY/PAUSE], [REC] and [SELECT] on the control unit flash simultaneously at the first beat of the metronome.

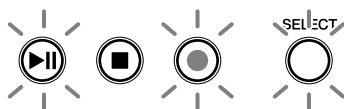

- 8** Start playing your song.

- 9** Press [STOP] when you finish playing your song.



The recorded song is loaded.

Recording the Left and Right Parts Separately

[RECORD] [FUNC.]

When recording an L/R song, the left- and right-hand parts can be recorded separately. Either part can be recorded first, and the pedals can be recorded with the first part.

While you record the second part, the first part will play back for monitoring.

If the left-hand or right-hand part is difficult to play at normal speed, the first part can be recorded at a slow tempo, and then the tempo changed afterwards to record the second part at the normal song speed.

This section describes how to record the left-hand part first then the right-hand part second.

1 Select a destination medium and album.

2 Press [RECORD].



3 Press [FUNC.] in the recording standby screen.

The part selection screen appears.



4 Make sure that the left-hand part is set to be recorded ("L=REC"), then press [PLAY].



This Disklavier is now ready for you to play the left-hand part.

5 Start playing your song.

Recording will start as soon as you touch a key.

6 Press [STOP] when you finish playing your song.



The L/R song with the left-hand part recorded is saved onto the selected album.

Next, record the right-hand part overwriting the left-hand part that you have just recorded.



To select a medium and album, see Chapter 3 "Basic Song Playback – Selecting Medium and Their Contents" on page 17.



In the case you want to title your new song before recording, see Chapter 6 "Basic Recording – Titling a Song at the Start of Recording" on page 46, to rename the title after recording, see Chapter 8 "Media Management – Renaming a Song" on page 71.

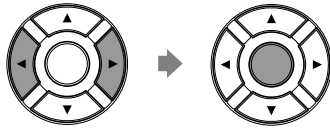

If you want to record your L/R song using the metronome, see Chapter 7 "Advanced Recording – Recording with the Internal Metronome" on page 48.

7 Press [RECORD].**8** Press [◀] and [▶] to select the L/R song with the left-hand part that you have just recorded, then press [ENTER].**9** Press [FUNC.] in the recording standby screen.

The part selection screen appears.



The part that has already been recorded is displayed as “L=PLY.”

10 Press [PART SELECT R] to record the right-hand part.

The part set to “REC” will be recorded.

11 Press [PLAY].

Playback of the left-hand recorded part starts immediately, so be sure that you are ready to play the right-hand part along with it.

Advanced Recording

12 Press [STOP] when you finish playing your song.

The following screen appears.



The following table gives a description of each of the options.

Option	Description
SAVE	The second part is saved with the first part under the current song number, overwriting the previously saved first part.
NEW	The second part is saved under a new song number. The first part is kept under the previous song number.
CANCEL	The second part is discarded. The first part is kept under the previous song number.

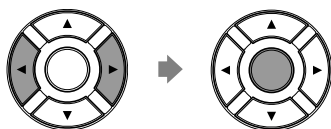
13 Press [◀] and [▶] to select an option, then press [ENTER].

The right-hand part is saved as indicated or canceled.

Recording the Left and Right Parts Together (Setting a Split Point)

[RECORD] [FUNC.]

You can also record an L/R song by playing the left- and right-hand parts simultaneously. In this case, a keyboard split point is set, and the notes played on the left-hand side of the split point are saved as the left-hand part, and notes played on the right-hand side of the split point are saved as the right-hand part.

1 Select a destination medium and album.**2** Press [RECORD].**3** Press [FUNC.] in the recording standby screen.

The part selection screen appears.



To select a medium or album, see Chapter 3 “Basic Song Playback – Selecting Medium and Their Contents” on page 17.



In the case you want to title your new song before recording, see Chapter 6 “Basic Recording – Titling a Song at the Start of Recording” on page 46, to rename the title after recording, see Chapter 8 “Media Management – Renaming a Song” on page 71.



If you want to record your L/R song using the metronome, see Chapter 7 “Advanced Recording – Recording with the Internal Metronome” on page 48.

4 Press [PART SELECT R] to set both parts to record.

The split point setting screen appears.



The above display shows that the default keyboard split point is note C3, or middle C. In this case, note C3 and notes below are saved as the left-hand part and notes above C3 are saved as the right-hand part, as shown in the following figure.

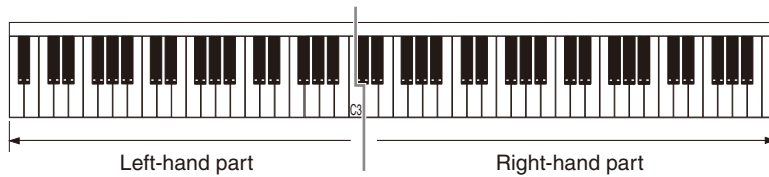

5 To change the split point, press a key on the keyboard or [+ / YES] and [- / NO] to select a different key.

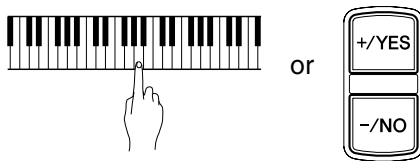

The split point can be set from note A-1 to note C7.

6 Press [PLAY].



The Disklavier is now ready for you to play.

7 Starts playing your song with the left- and right-hand parts and the pedal part simultaneously.

Recording will start as soon as you touch a key.

8 Press [STOP] when you finish playing your song.



The recorded song is loaded.

Re-Recording One Part

[RECORD] → Select the L/R song → [PART SELECT L] or [PART SELECT R]

You can re-record the only one part left-hand or the right-hand of the existing L/R song.

1 Select a desired medium and album.

2 Press [RECORD].



3 Press [◀] and [▶] to select the L/R song that you want to re-record, then press [ENTER].

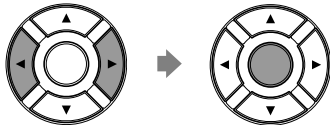

4 Press [PART SELECT L] or [PART SELECT R] to select the part to re-record.



The part set to “REC” will be re-recorded.

5 Press [PLAY].



Recording will start immediately, so be sure that you are ready to play the part.

6 Press [STOP] when you finish playing your song.

The following screen appears.



To select a medium and album, see Chapter 3 “Basic Song Playback – Selecting Medium and Their Contents” on page 17.

The following table gives a description of each of the options.

Option	Description
SAVE	The re-recorded part is saved with the other existing part under the current song number.
NEW	The re-recorded part is saved under a new song number. The existing parts are kept under the current song number.
CANCEL	The re-recorded part is discarded. The existing parts are kept under the current song number.

7 Press [◀] and [▶] to select an option, then press [ENTER].

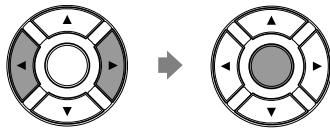

The re-recorded part is saved as indicated or canceled.

Changing the Default Tempo

[RECORD] → Select the song → [FUNC.]x3

This function allows you to change the default tempo of a song and save the change. It should not be confused with the playback tempo function described in Chapter 4 “Advanced Song Playback – Changing the Playback Tempo” in which tempo changes are lost when the Disklavier is turned off.

The tempo of a song can be changed many times. This function can be used when recording a very complex song that is difficult to play at a fast tempo. First, record the song at a tempo you can manage, then change the tempo afterwards. For example, you could record a difficult left-hand part at a slow tempo, use this function to change the tempo, then record the right-hand part at the normal tempo.

If a song’s time format is minutes and seconds, tempo changes are specified as a percentage of the original tempo.

If a song’s time format is measures and beats, tempo changes are specified in beats per minute.

1 Select a desired medium and album.

2 Press [RECORD].



To select a medium or album, see Chapter 3 “Basic Song Playback – Selecting Medium and Their Contents” on page 17.

Advanced Recording

- 3** Press [◀] and [▶] to select the song in which you want to change the tempo, then press [ENTER].

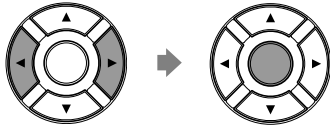

- 4** Press [FUNC.] three times.

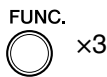

For **measures and beats**, the current song tempo (bpm) is shown.



For **minutes and seconds**, the current song tempo is shown as "000%."

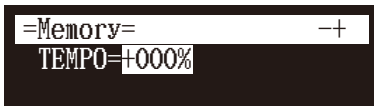

- 5** Press [+ / YES] and [- / NO] to change the tempo.

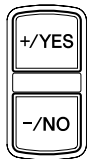

[+ / YES] increases the tempo, and [- / NO] decreases the tempo.

For **measure and beats**, the tempo range is from 30 bpm to 400 bpm.

For **minutes and seconds**, the tempo range is from -75% to +242%.

- 6** Press [STOP] to save the tempo change.

The following screen appears.



The following table gives a description of each of the options.

Option	Description
SAVE	The song is saved at its new tempo under the current song number.
NEW	The song is saved at its new tempo under a new song number. The original song is kept under the previous song number.
CANCEL	The song with a new tempo is discarded. The original song is kept under the previous song number.

Note:

You cannot change the beat setting on the prerecorded songs.

- 7** Press [◀] and [▶] to select an option, then press [ENTER].

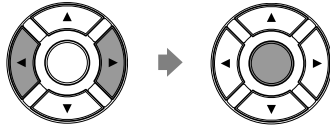

To change the tempo again or to reset the original tempo, repeat steps 1 to 6.

Video Synchronized Recording

[SETUP] → "AudioI/O" → **Connect a camcorder and a DVD recorder**

By recording a song played on the Disklavier synchronized with the video recording, later on, you can enjoy piano playback with the video. First set up the camcorder, the DVD recorder, and the Disklavier, and then start recording by following the procedures below.



For details on video synchronized playback, see Chapter 4 "Advanced Song Playback – Video Synchronized Playback" on page 39.

■ Setting for Video Synchronized Recording

- 1** Press [SETUP] on the remote control.

The setup menu screen appears.



- 2** Select "AudioI/O" with the cursor buttons ([◀] [▶] [▲] [▼]), then press [ENTER].



The audio I/O setting screen appears.

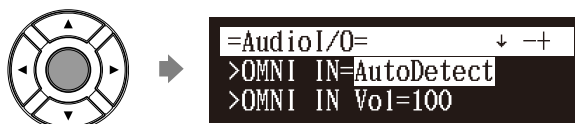

Advanced Recording

- 3** Select “OMNI IN” with the cursor buttons ([▲] [▼]), then press [+ / YES] and [- / NO] to change setting to “Auto Detect”.

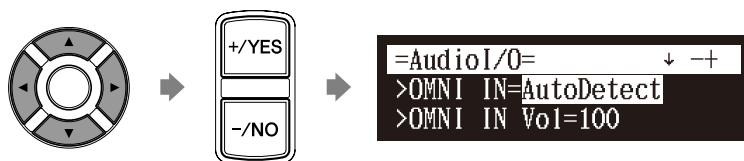

- 4** Select “OMNI OUT” with the cursor buttons ([▲] [▼]), then press [+ / YES] and [- / NO] to change setting to “SYNC”.

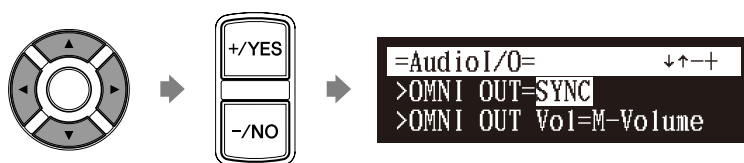

- 5** Press [ENTER] to complete the operation.

- 6** Connect a camcorder and a DVD recorder to the control unit.

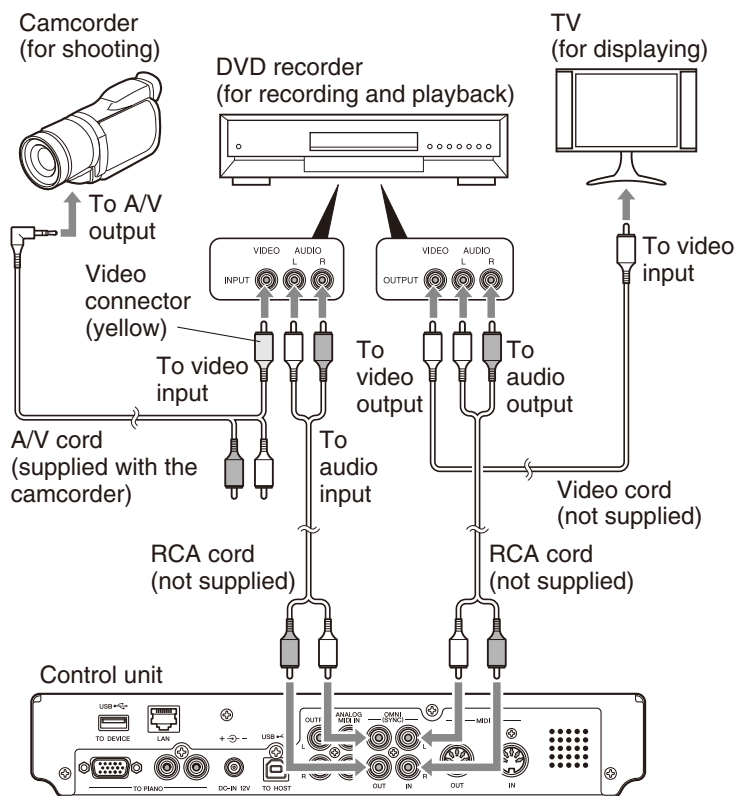
**Note:**

Confirm the shape of input/output connectors on the camcorder and the DVD recorder, and prepare the cables fit to them.

■ Starting Video Synchronized Recording

1 Select a destination medium and album.

2 Press [RECORD].

The video synchronized recording standby screen appears, and [RECORD] on the control unit lights red, and [PLAY/PAUSE] flashed in green.

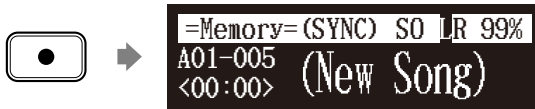

3 Set the camcorder to video shooting mode.

4 Select the video input on the DVD recorder which the camcorder is connected to, then start recording on the DVD recorder.

5 Press [PLAY].

[PLAY/PAUSE] stops flashing, and the counter starts to advance.

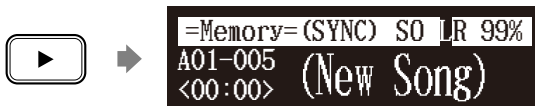

6 Wait for approximately ten seconds, and then start playing your song.

7 Press [STOP] when you finish playing your song.



8 Stop recording on the DVD recorder.



To select a medium and album, see Chapter 3 “Basic Song Playback – Selecting Medium and Their Contents” on page 17.

Note:

This step is necessary for synchronization of the song and the video playback, and should not be omitted.

■ Using the Camcorder only

If your camcorder has both mic input and audio output, you can perform video synchronized recording using the camcorder only.

1. Set the Disklavier following the procedures 1 to 5 on page 57.
2. Connect a camcorder to the control unit.

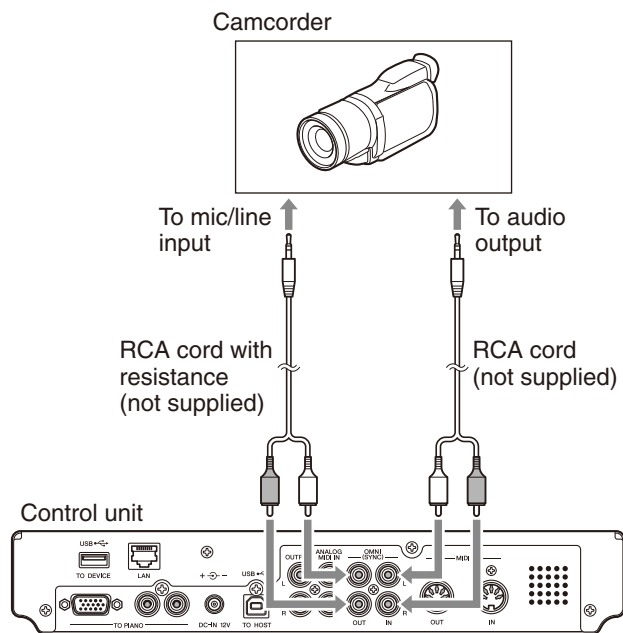

3. Select a destination medium and album.
4. Press [RECORD].
5. Start recording on the camcorder.
6. Press [PLAY].
7. Wait for approximately ten seconds, and then start playing your song.
8. Press [STOP] when you finish playing your song.
9. Stop recording on the camcorder.

CD Synchronized Recording

Insert an audio CD **[RECORD]**

You can record a Disklavier piano performance along with the playback of songs on commercial CDs.

- 1** Select a destination medium and album, then song in the selected album.
- 2** Insert an audio CD and select the song that you want to synchronize with.
- 3** Press **[RECORD]**.

The SPS recording standby screen appears, and **[RECORD]** on the control unit lights red, and **[PLAY/PAUSE]** flashes in green.

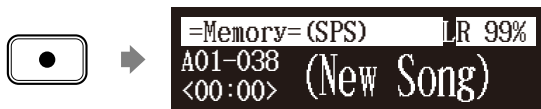

- 4** Select the desired part of a song, then press **[PLAY]** to start synchronizing.



Recording begins with the CD playback.

- 5** Start playing the Disklavier along with the CD playback.

- 6** Press **[STOP]** to stop recording.



The recorded song is loaded.

Note:

The Disklavier recognizes the destination album by selecting the song in it. Note that the selected song is not overwritten by this procedure.



To select a medium and album, see Chapter 3 “Basic Song Playback – Selecting Medium and Their Contents” on page 17.



To play back the performance recorded with this feature, see Chapter 4 “Advanced Song Playback – Adding Disklavier Accompaniment to Commercial CD Songs (PianoSmart™ Playback)” on page 40.

Media Management

This chapter describes how to manage contents inside the media, such as managing albums, songs and playlists.

Managing Albums

Album selection screen [FUNC.]

You can use the album function menu for creating, deleting and copying albums inside a medium.

1 Press [FUNC.] in the album selection screen.

The album function menu screen appears.



2 Select a desired function with the cursor buttons ([◀] [▶] [▲] [▼]), then press [ENTER].

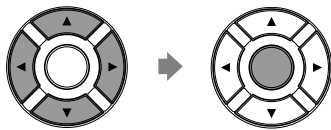

The following functions are available:

- CopyAlbum
- DeleteAlbum
- NewAlbum
- RenameAlbum
- SortAlbum
- AddToPList
- DeleteList
- NewList
- RenameList



To select a album, see Chapter 3 “Basic Song Playback – Selecting Medium and Their Contents” on page 17.

Note:

Available functions vary depending on the medium you selected.



About playlists, see Chapter 8 “Media Management – Managing Playlists” on page 76.

Making Copies of Albums

Album selection screen [FUNC.] “CopyAlbum”

You can make copies of the album to the different medium.

This function is available for albums on [Memory], [CD](CD-ROM), [USB1], [USB2] and [FromToPC].

Note:

Up to 99 albums can be saved in a medium.

- 1** Select “CopyAlbum” in the album function menu, then press [ENTER].

```
=ALBUM MENU= (1/2) →
*CopyAlbum *DeleteAlbum
*NewAlbum *RenameAlbum
```

The CopyAlbum screen appears.



- 2** Select a destination medium with [+ / YES] and [- / NO].



- 3a** To copy to the new album, press [ENTER].

“OK?” flashes in the first line of the screen.



- 3b** To add to the existing album, press [▶] to move the cursor to the album, and press [+ / YES] and [- / NO] to select the album, then press [ENTER].

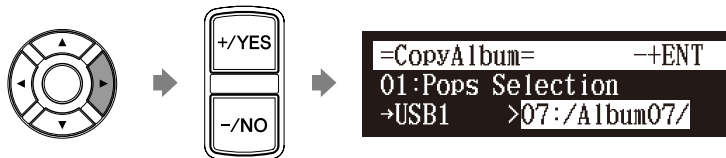

“OK?” flashes in the first line of the screen.



- 4** Press [+YES] to make a copy, [-/NO] to cancel.



After a while, the completion message appears.
Press any button to return to the album selection screen.

Deleting Albums

Album selection screen → [FUNC.] → "DeleteAlbum"

You can delete the albums.

This function is available for albums on [Memory], [USB1], [USB2] and [FromToPC].

- 1** Select "DeleteAlbum" in the album function menu, then press [ENTER].



The DeleteAlbum screen appears.



- 2** Press [ENTER].

"OK?" flashes in the first line of the screen.



- 3** Press [+YES] to delete the album, [-/NO] to cancel.



After a while, the completion message appears.
Press any button to return to the album selection screen.

Creating a New Album

Album selection screen → [FUNC.] → "NewAlbum"

You can create a new album into the selected medium.

This function is available for albums on [Memory], [USB1] and [USB2].

- 1 Select the "NewAlbum" in the album function menu, then press [ENTER].



The NewAlbum screen appears.

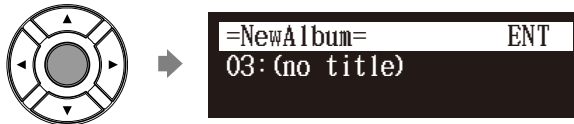

- 2 Press [ENTER].

The album title editing screen appears.



- 3 Enter a title to a new album.



You can enter up to 64 characters.

Follow the instructions in "Entering Characters" on page 47.

- 4 Press [ENTER].

"OK?" flashes in the first line of the screen.



Note:

Up to 99 albums can be created in a medium.

Note:

If you enter the same title as the album already exists, the new album is titled in the form of "album title xx" ("xx" indicates the number).

- 5** Press [+YES] to create a new album, [-/NO] to cancel.



After a while, the completion message appears.
Press any button to return to the album selection screen.

Renaming an Album

Album selection screen → [FUNC.] → "RenameAlbum"

You can rename the albums which already named.
This function is available only for albums on [Memory].

- 1** Select "RenameAlbum" in the album function menu, then press [ENTER].



The RenameAlbum screen appears.



- 2** Press [ENTER].

The album title editing screen appears.



- 3** Enter a new title to the selected album.



You can enter up to 64 characters.
Follow the instructions in "Entering Characters" on page 47.

4 Press [ENTER].

"OK?" flashes in the first line of the screen.

**5** Press [+ / YES] to rename, [- / NO] to cancel.

After a while, the completion message appears.
Press any button to return the album selection screen.

Rearranging the Order of Albums

Album selection screen → [FUNC.] → "SortAlbum"

You can rearrange the order of albums that you selected.
This function is available only for albums on [Memory].

1 Select "SortAlbum" in the album function menu, then press [ENTER].

The SortAlbum screen appears.

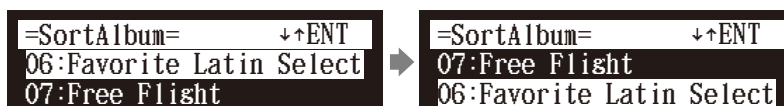
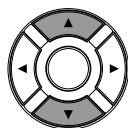
**2** Press [▲] and [▼] to move the albums to the desired position.

3 Press [ENTER].

“OK?” flashes in the first line of the screen.

**4** Press [+ / YES] to rearrange, [- / NO] to cancel.

After a while, the completion message appears.
Press any button to return to the album selection screen.

Managing Songs

Song selection screen **[FUNC.]**

You can use the song function menu for managing the copy or the deletion songs inside the album.

1 Press [FUNC.] in the song selection screen.

The song function menu screen appears.

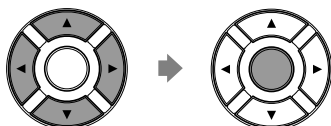
**2** Select a desired function with the cursor buttons ([<], [>], [▲], [▼]), then press [ENTER].

The following functions are available:

- CopySong
- DeleteSong
- RenameSong
- SortSong
- AddToPList
- ConvertSong
- Counter
- Strip XP



To select the song, see Chapter 3 “Basic Song Playback – Selecting Medium and Their Contents” on page 17.

Note:

Available functions vary depending on the medium you selected.

Note:

If there is no available function or no song, the song function menu screen does not appear although pressing [FUNC.].



About playlists, see Chapter 8 “Media Management – Managing Playlists” on page 76.

Making Copies of Songs

Song selection screen [FUNC.] "CopySong"

You can copy songs stored on an album to another.

This function is available for song in the album on [Memory], [CD](CD-ROM), [USB1], [USB2] and [FromToPC].

- 1 Select "CopySong" in the song function menu, then press [ENTER].

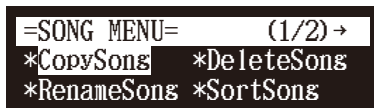

The CopySong screen appears.



- 2 Select a destination medium with [+ / YES] and [- / NO].



- 3 Press [▶] to move the cursor to the album, and press [+ / YES] and [- / NO] to select a destination album.

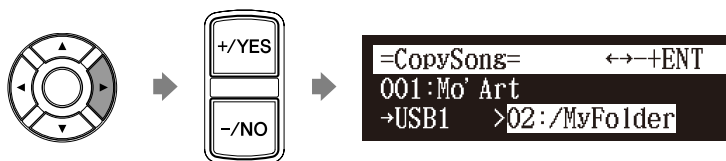

- 4 Press [ENTER].

"OK?" flashes in the first line of the screen.



Note:

Copy-protected songs, such as PianoSoft songs, cannot be copied to a removable medium.

Note:

Up to 999 songs can be saved in an album.

- 5** Press [+YES] to make a copy, [-/NO] to cancel.



After a while, the completion message appears.
Press any button to return to the song selection screen.

Deleting Songs

Song selection screen → [FUNC.] → "DeleteSong"

You can delete songs stored on an album.

This function is available for songs in the album on [Memory], [USB1], [USB2], [Playlist] and [FromToPC].

- 1** Select "DeleteSong" in the song function menu, then press [ENTER].



The DeleteSong screen appears.



- 2** Press [ENTER].

"OK?" flashes in the first line of the screen.



- 3** Press [+YES] to delete the song, [-/NO] to cancel.



After a while, the completion message appears.
Press any button to return to the song selection screen.

Renaming a Song

Song selection screen [FUNC.] "RenameSong"

You can rename the songs which already named.

This function is available for songs in the album on [Memory], [USB1], [USB2] and [FromToPC].

- 1 Select "RenameSong" in the song function menu, then press [ENTER].

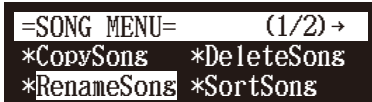

The RenameSong screen appears.



- 2 Press [ENTER].

The song title editing screen appears.



- 3 Enter a new title to the selected song.

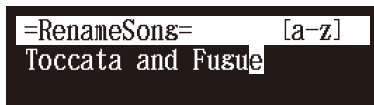

You can enter up to 64 characters.

Follow the instructions in "Entering Characters" on page 47.

- 4 Press [ENTER].

"OK?" flashes in the first line of the screen.



- 5** Press [+ / YES] to rename, [- / NO] to cancel.



After a while, the completion message appears.
Press any button to return to the song selection screen.

Rearranging the Order of Songs

Song selection screen [FUNC.] "SortSong"

You can rearrange the order of songs in an album.

This function is available only for songs in the album on [Memory] and [Playlist].

- 1** Select "SortSong" in the song function menu, then press [ENTER].

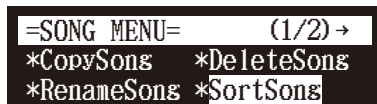

The SortSong screen appears.



- 2** Press [▲] and [▼] to move the songs to the desired position.

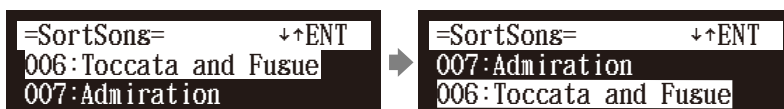
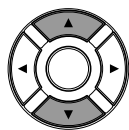

3 Press [ENTER].

“OK?” flashes in the first line of the screen.

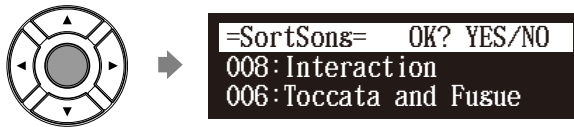
**4** Press [+ / YES] to rearrange, [- / NO] to cancel.

After a while, the completion message appears.
Press any button to return to the song selection screen.

Converting Song Format

Song selection screen [FUNC.] **ConvertSong**

The song format can be converted to other format.

This function is available for songs in the album on [Memory], [USB1], [USB2] and [FromToPC].

Note:

The converted song will be newly added to the end of the album.

1 Select “ConvertSong” in the song function menu, then press [ENTER].

The ConvertSong screen appears.

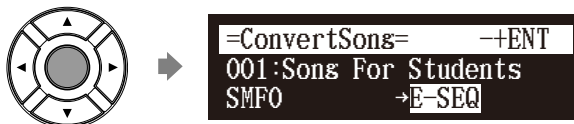

2 Press [+YES] and [-/NO] to select a song format.



The following options are available:

Option	Song Format
E-SEQ	E-SEQ format
SMF0	SMF (Standard MIDI File) format 0
SMF1	SMF (Standard MIDI File) format 1
Piano1	E-SEQ format to play on all Disklavier in correct tempo

3 Press [ENTER].

“OK?” flashes in the first line of the screen.

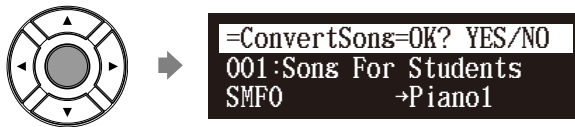

4 Press [+YES] to convert, [-/NO] to cancel.



After a while, the completion message appears.
Press any button to return to the song selection screen.

Changing the Counter Display

Song selection screen → [FUNC.] → “Counter”

The counter display of a song can be changed from “measures and beats”(metronome) to “minutes and seconds” or vice versa.

This function is available for songs in the album on [Memory], [USB1], [USB2] and [FromToPC].

- 1** Select “Counter” in the song function menu, then press [ENTER].

```
=SONG MENU=      ← (2/2)
*AddToPList *ConvertSongs
*Counter         *Strip XP
```

The CounterChange screen appears.

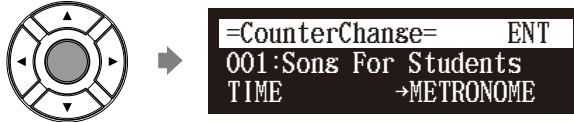

TIME: minutes and seconds display

METRONOME: measures and beats display

- 2** Press [ENTER].

“OK?” flashes in the first line of the screen.

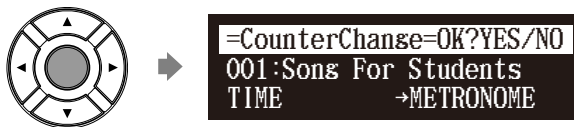

- 3** Press [+ / YES] to change, [- / NO] to cancel.

```
=CounterChange=  ANY
Executing...      Completed.
                  Press any button.
```

After a while, the completion message appears.

Press any button to return to the song selection screen.

Converting MIDI Data to a Standard Form (Strip XP)

Song selection screen → [FUNC.] → “Strip XP”

Some Disklavier pianos record highly precise control information (XP events) that becomes part of the MIDI song files. This data is used to achieve accurate playback on the Disklavier PRO model, but is not used when the file is played back on general MIDI devices. When you edit the song with external MIDI devices (for example a software sequencer), the relationship between the note data and the XP event as well as the actual performance may not be maintained. There may be cases in which songs edited in this manner cannot be played back normally, depending on the instrument’s settings. In such cases, use the Strip XP function to remove the XP event to convert the song to standard MIDI format before using it for playback. Strip XP also makes it possible to reduce the size of MIDI files when desired.

Note:

Once the XP event is stripped, the original data cannot be restored. Before converting valuable music data, be sure to backup the original data.

- 1 Select “Strip XP” in the song function menu, then press [ENTER].

```
=SONG MENU=      ← (2/2)
*AddToPList *ConvertSongs
*Counter      *Strip XP
```

The Strip XP screen appears.

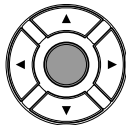

```
=Strip XP=      ENT
008:XP Song
```

- 2 Press [ENTER].

“OK?” flashes in the first line of the screen.



```
=Strip XP=      OK? YES/NO
008:XP Song
```

- 3 Press [+ / YES] to execute, [- / NO] to cancel.

```
=Strip XP=
Executing . .
```



```
=Strip XP=      ANY
Completed.
Press any button.
```

After a while, the completion message appears.
Press any button to return to the song selection screen.

Managing Playlists

By creating lists of your favorite songs, you can program your Disklavier to automatically play back a series of songs.

At the initial factory settings, no playlist is created in the internal flash memory. First create your own playlist, then play back that list.



To create a playlist, see Chapter 8 “Media Management – Creating a New Playlist” on page 79.

Adding Songs/Albums to the Playlist

Media selection screen → "Memory" → Album or song selection screen → [FUNC.] → "AddToPList"

This function is available only for songs/albums on [Memory].

- 1 Select "AddToPList" in the album or song function menu, then press [ENTER].



The AddToPList screen appears.



- 2 Select a destination playlist with [+ /YES] and [- /NO].

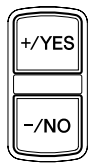

- 3 Press [ENTER].

"OK?" flashes in the first line of the screen.

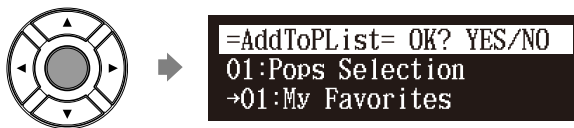

- 4 Press [+ /YES] to add, [- /NO] to cancel.



After a while, the completion message appears.
Press any button to return to the album or song selection screen.

Note:

Up to 999 songs can be added to a playlist.

Note:

You cannot add songs on media other than [Memory] directly to the playlist. First copy songs to the internal flash memory.

Note:

If "New Playlist" is selected in step 2, the title of added album is copied to that playlist.

Note:

If you select "New Playlist" and add songs to it, the playlist is titled as "My Playlist."

Note:

The new playlist created in this procedure can be selected from "Playlist" in the media selection screen.

Deleting a Playlist

Media selection screen → "Playlist" → Album selection screen → [FUNC.] → "DeleteList"

You can delete the playlists which already registered.

- 1 Select "DeleteList" in the album function menu for the playlist, then press [ENTER].

```
=ALBUM MENU= (1/1)
*DeleteList *NewList
*RenameList
```

The DeleteList screen appears.

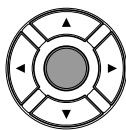

```
=DeleteList= ENT
02:My Best Collection
```

- 2 Press [ENTER].

"OK?" flashes in the first line of the screen.

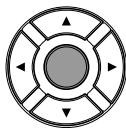

```
=DeleteList= OK? YES/NO
02:My Best Collection
```

- 3 Press [+ / YES] to delete the playlist, [- / NO] to cancel.

```
=DeleteList=
Executing. . .
```



```
=DeleteList= ANY
Completed.
Press any button.
```

After a while, the completion message appears.

Press any button to return to the album selection screen for the playlist.

Note:

Even if you delete the playlist, songs or albums added to that playlist remain in the internal flash memory.

Creating a New Playlist

Media selection screen → "Playlist" → Album selection screen → [FUNC.] → "NewList"

You can create a new playlist for playing back your favorite songs in your selected order.

- 1 Select "NewList" in the album function menu for the playlist, then press [ENTER].



The NewList screen appears.

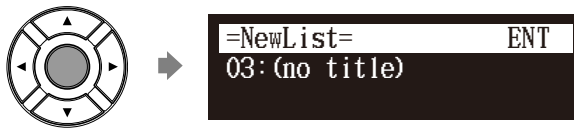

- 2 Press [ENTER].

The playlist title editing screen appears.



- 3 Enter a title to a new playlist.



You can enter up to 64 characters.

Follow the instructions in "Entering Characters" on page 47.

- 4 Press [ENTER].

"OK?" flashes in the first line of the screen.



Note:

Up to 99 playlists can be created.

Note:

If you enter the same title as the playlist already exists, the new playlist is titled in the form of "playlist title [xx]" ("xx" indicates the number).

- 5** Press [+YES] to create a new playlist, [-/NO] to cancel.



After a while, the completion message appears.
Press any button to return to the album selection screen for the playlist.

Note:

The new playlist created in this procedure can be selected from "Playlist" in the media selection screen.

Renaming a Playlist

Media selection screen → "Playlist" → Album selection screen → [FUNC.] → "RenameList"

You can rename a playlist which already registered.

- 1** Select "RenameList" in the album function menu for the playlist, then press [ENTER].



The RenameList screen appears.



- 2** Press [ENTER].

The playlist title editing screen appears.



- 3** Enter a new title to the selected playlist.



You can enter up to 64 characters.
Follow the instructions in "Entering Characters" on page 47.

4 Press [ENTER].

“OK?” flashes in the first line of the screen.

**5** Press [+ / YES] to rename, [- / NO] to cancel.

After a while, the completion message appears.
Press any button to return to the album selection screen for the playlist.

Managing Media

Media selection screen **[FUNC.]**

You can use the media function menu for copying or deleting entire contents inside the media.

1 Press [FUNC.] in the media selection screen.

The media function menu screen appears.

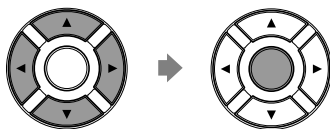
**2** Select a desired function with the cursor buttons ([<] [>] [▲] [▼]), then press [ENTER].

The following functions are available:

- CopyAll
- DeleteAll
- Format
- Refresh



To select a media, see Chapter 3 “Basic Song Playback – Selecting Medium and Their Contents” on page 17.

Note:

Available functions vary depending on the medium you selected.

Note:

If there is no available functions, the media function menu screen does not appear although pressing [FUNC.].

Making Copies of the Entire Contents in a Medium

Media selection screen → [FUNC.] → "CopyAll"

You can copy the entire contents in a medium to the another medium.

The function is available for [Memory], [CD](CD-ROM), [USB1], [USB2] and [FromToPC].



To select a medium, see Chapter 3 "Basic Song Playback – Selecting Medium and Their Contents" on page 17.

- 1 Select "CopyAll" in the media function menu, then press [ENTER].



The CopyAll screen appears.

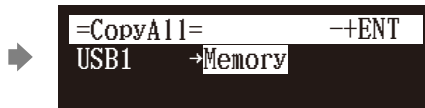
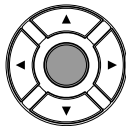

- 2 Select a destination medium with [+ / YES] and [- / NO].

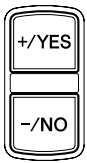

- 3 Press [ENTER].

"OK?" flashes in the first line of the screen.

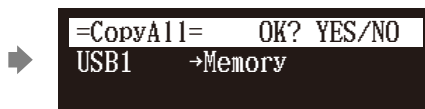
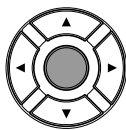

- 4 Press [+ / YES] to make a copy, [- / NO] to cancel.

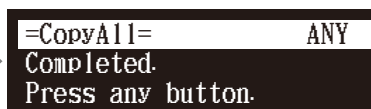

After a while, the completion message appears.
Press any button to return to the media selection screen.

Note:

Confirm that the destination medium has enough space to store the contents.

Note:

If the maximum number of the albums in the destination medium exceeds 99, copying stops.

Deleting the Entire Contents in a Medium

Media selection screen → [FUNC.] → "DeleteAll"

You can delete the entire contents in a medium.

This function is available for [Memory], [USB1], [USB2] and [FromToPC].



To select a medium, see Chapter 3 "Basic Song Playback – Selecting Medium and Their Contents" on page 17.

- 1 Select "DeleteAll" in the media function menu, then press [ENTER].



The DeleteAll screen appears.



- 2 Press [ENTER].

"OK?" flashes in the first line of the screen.



- 3 Press [+ / YES] to delete, [- / NO] to cancel.



After a while, the completion message appears.
Press any button to return to the media selection screen.

Copying Song File from a Personal Computer to the Disklavier

You can copy song files from a Windows or Macintosh computer to a special folder on the Disklavier called [FromToPC] and then play them on the Disklavier.

- 1 Connect the control unit to a LAN (local area network) to which a personal computer with a song file is also connected.**

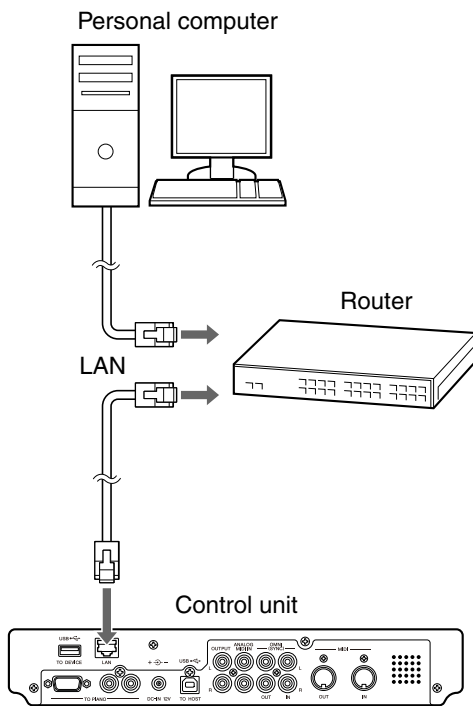

Note:

Copy-protected files, such as PianoSoft and PianoSoft-Plus songs, cannot be copied to the [FromToPC] folder.

Note:

Do not copy the files other than Disklavier song files.

Note:

Do not access the [FromToPC] folder while the Disklavier is engaged in another operation (such as file copying or deleting).

Note:

It is necessary to configure the Disklavier properly for network communications by enabling it to get a DHCP IP address automatically (recommended) or by assigning an appropriate address manually. The procedure is the same as the one used for setting up the Disklavier for Internet communications. Please follow the instructions in Chapter 9 “Internet Direct Connection (IDC) – Setting the Disklavier for the Internet Connection” on page 99.

Note:

Use an STP (shielded twisted pair) cable for connection. For details, see Chapter 9 “Internet Direct Connection (IDC) – Connecting the Disklavier to the Internet” on page 93.

Note:

For information about configuring a personal computer for network communications, please refer to the documentation that came with the computer.

For Windows

- 2** On the computer screen, click [Start] and then select [My Network Places].

The [My Network Places] window appears. Confirm that the [Dkv*****] icon is shown in the [My Network Places] window.

- 3** Double-click the [Dkv*****] icon.

The [Dkv*****] folder opens. Confirm that the [FromToPC] icon is shown in the [Dkv*****] folder.

- 4** Double-click the [FromToPC] icon.

The [FromToPC] folder opens.

- 5** Copy the desired song files to the [FromToPC] folder.

- 6** Refresh the contents in the folder.

■ For Windows: In case that you cannot find the [Dkv*****] icon

1. Press [SETUP] on the remote control.
2. Select "Network" in the setup menu screen.
3. Select "Information" to display the information of network settings.
4. Press [▼] several times to display "NAME=DKV*****" and memorize that name.
5. Open the [My Network Places] on the computer, and then click the [Search] icon on the top of the window.
6. Enter the name confirmed in step 4 in the [Computer name] box, and then click [Search] to start searching.
7. Open [Dkv*****] and confirm that the [FromToPC] folder is shown under that.
8. Copy the desired song files to the [FromToPC] folder.

Note:

[Dkv*****] differs depending on each Disklavier.

Note:

The folder or icon name differs depending on the version of your operating system.



See Chapter 8 "Media Management – Refreshing the Contents in [FromToPC]" on page 88.

Media Management

For Mac OS X 10.3 or 10.4

- 2** Click the [Finder] icon in the dock, and then click the [Network] icon in the left side of the window.

The [Network] window appears. Confirm that the [Dkv] icon is shown in the [Network] window.

- 3** Click the [Dkv] icon.

The [Dkv] folder opens. Confirm that the [Dkv*****] icon is shown in the [Dkv] folder.

- 4** Click the [Dkv*****] icon.

- 5** In the first dialog that appears, select [FromToPC] from the mini-menu and click [OK].

- 6** Click [OK] again in the next dialog that appears.

Connection process completes and the [FromToPC] icon appears in the left side of the window.

- 7** Click the [FromToPC] icon.

The [FromToPC] folder opens.

- 8** Copy the desired song files to the [FromToPC] folder.

- 9** Refresh the contents in the folder.

Note:

[Dkv*****] differs depending on each Disklavier.

Note:

If the user ID and password are required during the process, enter any name for the ID and leave the space for the password blank.



See Chapter 8 “Media Management – Refreshing the Contents in [FromToPC]” on page 88.

■ For Mac OS X 10.5 or later

- 2 Click the [Finder] icon in the dock, and then select [Go] and then [Network] from the menu bar.

The [Network] window appears. Confirm that the [Dkv*****] icon is shown in the [Network] window.

- 3 Click the [Dkv*****] icon.

The [Dkv*****] folder opens. Confirm that the [FromToPC] icon is shown in the [Dkv*****] folder.

- 4 Click the [FromToPC] icon.

The [FromToPC] folder opens.

- 5 Copy the desired song files to the [FromToPC] folder.

- 6 Refresh the contents in the folder.

■ For Macintosh: In case that you cannot find the [Dkv*****] icon

1. Press [SETUP] on the remote control.
2. Select "Network" in the setup menu screen.
3. Select "Information" to display the information of network settings.
4. Press [▼] several times to display "NAME=DKV*****" and memorize that name.
5. Select [Go] and then [Connect to Server] from the menu bar on the computer.
6. Enter the name confirmed in step 4 in the address field, and then click [Connect]. Use syntax "smb:///" when entering the name ("smb://Dkv*****").
7. Select [FromToPC] from the mini-menu in the first window appears and click [OK]. Click [OK] again in the next window that appears.
8. Copy the desired song files to the [FromToPC] folder on the left side of the finder window.

Note:

[Dkv*****] differs depending on each Disklavier.

Note:

If the user ID and password are required during the process, enter any name for the ID and leave the space for the password blank.



See Chapter 8 "Media Management – Refreshing the Contents in [FromToPC]" on page 88.

Refreshing the Contents in [FromToPC]

Media selection screen → "FromToPC" → [FUNC.] → "Refresh"

You must refresh the contents in the [FromToPC] folder after copying song files from a personal computer, in order to play them on the Disklavier.



To select a medium, see Chapter 3 "Basic Song Playback – Selecting Medium and Their Contents" on page 17.

- 1 Select "Refresh" in the media function menu, then press [ENTER].



The Refresh screen appears.

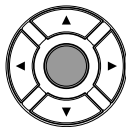

- 2 Press [ENTER].

"OK?" flashes in the first line of the screen.

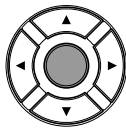

- 3 Press [+ / YES] to refresh, [- / NO] to cancel.

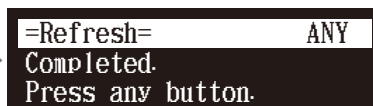
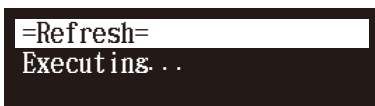

After a while, the completion message appears.
Press any button to return to the media selection screen.

Formatting the Floppy Disk (Optional)

Select the floppy disk [FUNC.] "Format"

In the case of using the unformatted floppy disk on the floppy drive (optional) or deleting the entire contents on the floppy disk, format the floppy disk.

- 1 **Connect the floppy drive (optional) to the USB port on the control unit.**
- 2 **Insert a floppy disk to the floppy drive.**
- 3 **Select "Format" in the media function menu, then press [ENTER].**



The Format screen appears.



- 4 **Press [ENTER].**

"OK?" flashes in the first line of the screen.



- 5 **Press [+ / YES] to format, [- / NO] to cancel.**



After a while, the completion message appears.
Press any button to return to the media selection screen.

Important:

Formatting a floppy disk erases all data that stored in the disk, so make sure that the disk you are going to format does not contain the data you want to keep.



To select a medium, see Chapter 3 "Basic Song Playback – Selecting Medium and Their Contents" on page 17.

Note:

If you are formatting a floppy disk, make sure that the floppy disk's erasure protection tab is set to "unprotected."

■ Floppy Disk Accidental Erasure Protection

Floppy disks have an erasure protection tab located on the reverse side of the disk in the bottom right-hand corner. When formatting a disk, make sure that its erasure protection tab is set to “unprotected.”

Protected

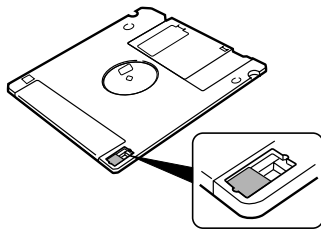

When the tab window is open, formatting and recording are not possible.

Unprotected

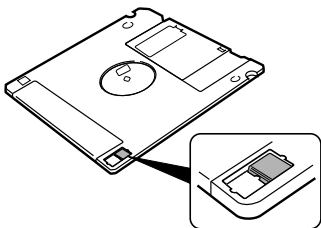

When the tab window is closed, formatting and recording are possible.

Making Backups of Songs

[SYSTEM] → “Backup”

You can make a backup copy of the songs and playlists. In order to protect your valuable music data, Yamaha strongly recommends that you backup your memory on regular basis.

If the floppy disk is inserted to the optional floppy disk drive, eject it before you start making backups.

1 Connect an external USB medium to the USB port on the control unit.

2 Press [SYSTEM] on the remote control.

The system menu screen appears.



Note:

Be sure to use the USB medium described in Chapter 2 “Getting Started – Compatible Media Format for the Removable Media” on page 14.

Note:

Make sure that the USB medium has enough space to save the backup data.

- 3** Select “Backup” with the cursor buttons ([◀] [▶] [▲] [▼]), then press [ENTER].



The Backup screen appears.

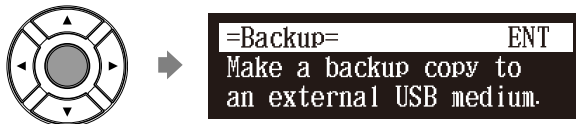

- 4** Press [ENTER].

“OK?” flashes in the first line of the screen.

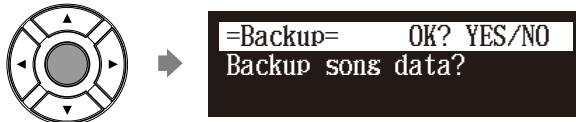

- 5** Press [+ / YES] to make a backup, [- / NO] to cancel.



After a while, the completion message appears.
Press any button to return to the system menu screen.

Restoring the Backups

[SYSTEM] → “Restore” →

You can restore the current condition of the internal memory to the previous condition that you made a backup copy.

- 1** Connect an external USB medium in which you made backup last time to the USB port on the control unit.
- 2** Press [SYSTEM] on the remote control.

The system menu screen appears.



To make a backup, see Chapter 8 “Media Management – Making Backups of Songs” on page 90.

Media Management

- 3** Select “Restore” with the cursor buttons ([◀] [▶] [▲] [▼]), then press [ENTER].

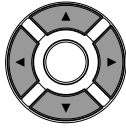

```
=SYSTEM MENU= (1/2) →
*Clock Adj. *TimeZone
*Backup *Restore
```

The Restore screen appears.



```
=Restore= ENT
Restore songs data from
USB medium.
```

- 4** Press [ENTER].

“OK?” flashes in the first line of the screen.



```
=Restore= OK? YES/NO
Restore this data?
Date:2007-10-22 15:42:00
```

- 5** Press [+ / YES] to restore, [- / NO] to cancel.

```
=Restore=
Executing. . .
DON' T REMOVE USB MEDIUM!
```



```
=Restore= ANY
Completed.
Press any button.
```

After a while, the completion message appears.
Press any button to return to the system menu screen.

Internet Direct Connection (IDC)

By connecting to the Internet, you can enjoy a streaming broadcast or download update programs directly.

What is Internet Direct Connection (IDC)?

Internet Direct Connection (IDC) is a feature that allows you to connect your Disklavier directly to the Internet. Internet Direct Connection users are able to listen to a streaming broadcast (DisklavierRadio), and receive valuable information such as product updates. Your Disklavier can be upgraded remotely as new technologies and services are developed through the IDC service.

Obtaining an ID and Password for the IDC Service (IDC Registration)

To use the IDC service, initial registration is required using an Internet-connected computer.

Please register at the following website:

<https://member.yamaha.com/myproduct/regist/>

Once you have an IDC account, you will interact with that account using the remote control. To use the full IDC service, you are required to enter your registered ID (e-mail address) and password with the remote control.

Note:

If you have already registered for the IDC service with any other instrument (such as the Clavinova), you do not need to register again. You can use your ID and password obtained through that registration.

Note:

Some IDC service functions do not require an ID and password.

Connecting the Disklavier to the Internet

You can connect the Disklavier to a full-time online Internet connection (ADSL, optical fiber, cable Internet, etc.) via a router or a modem equipped with a router.

■ Preparations

- To use the Internet connection, you will first need to subscribe to an Internet service or provider.
- Use a computer to obtain and configure Internet service. You cannot obtain Internet service or configure router settings on a local area network using the Disklavier itself.
- Use an STP (shielded twisted pair) cable to connect the control unit and a router.
- Before connecting the LAN cable, make sure to turn off (or shut down) the Disklavier.

Internet Direct Connection (IDC)

■ Connecting the Control Unit to the Internet

Connection example 1:

Using a modem with router function

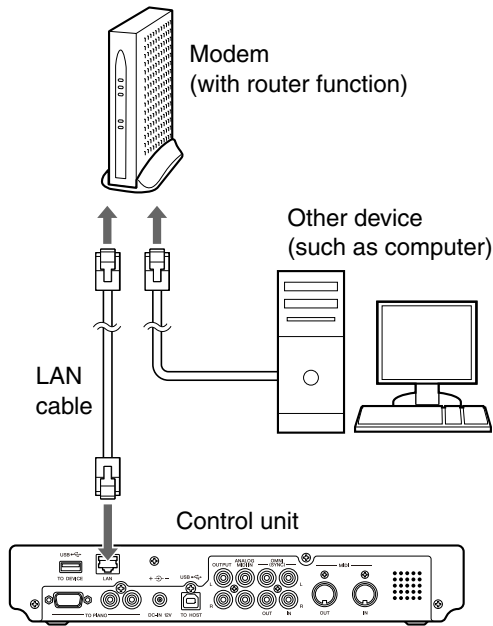

Connection example 2:

Using a modem without router function

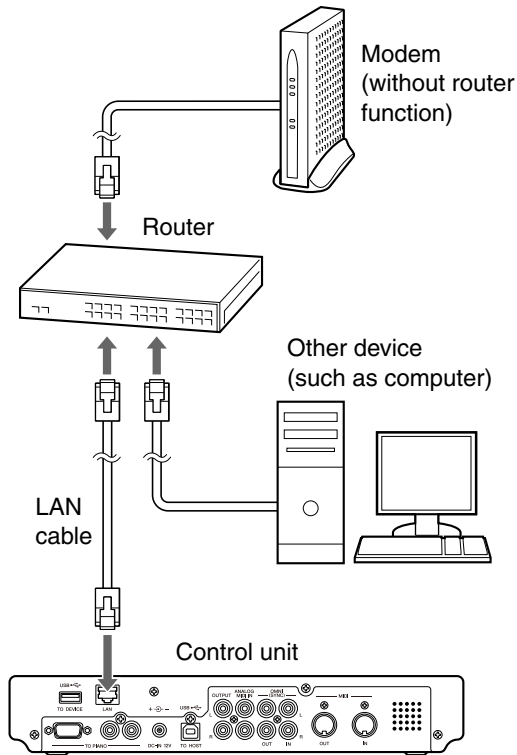

Note:

Depending on the contract with your Internet provider, you may not be able to connect two or more devices (for example, a computer and the Disklavier) to the Internet. Please check your contract or contact your Internet provider for further information.

Note:

Some types of modems (such as ADSL modems or cable modems) have multiple ports for connecting two or more devices (such as computer, musical instrument, etc.). If your modems have only one port, an optional router or hub is required in order to connect several devices simultaneously.

Note:

Use an STP (shielded twisted pair) cable for connection.

For further information on the Internet connection (only a wired LAN connection is supported), visit the Yamaha Disklavier website:

<http://services.music.yamaha.com/radio/>

■ Notes on Network Security

The Disklavier E3 attempts to achieve a balance between security and usability in its network implementation. However, a determined hacker may be able to defeat these security measures and utilize the network of the purchaser in an unauthorized manner. Since each network is different, only the purchaser can determine whether the security measures discussed here will adequately protect their network.

The purchaser acknowledges that connection to the Internet and use of the Disklavier E3 Internet features is done at the risk of the purchaser. In no event shall Yamaha, its subsidiaries or Yamaha's and/or its subsidiaries' directors, officers, or employees be responsible for unauthorized access, loss or alteration of the data of the purchaser or be liable for any damage from intrusions.

Accessing the Internet

[INTERNET]

Once you have established an IDC account and successfully connected your Disklavier to the Internet, you can access a special Disklavier website where you can access the DisklavierRadio, and download software updates.

D-Radio

Select this to listen to streaming broadcasts of music, with many channels of music content. You can enjoy listening to piano performances that play continuously.

MyAccount

Select this to log in to the IDC service. You can also refer to the help information from this option.

Update

Select this to update the Disklavier using Internet connection.

Note:

Free contents that do not require an ID and password are available.

Note:

The service contents are subject to change without prior notice.



See Chapter 3 "Basic Song Playback – Listening to the DisklavierRadio™" on page 25.

Internet Direct Connection (IDC)

1 Press [INTERNET] on the remote control.

The Internet menu screen appears.



2 Select a desired menu with the cursor buttons ([◀] [▶] [▲] [▼]), then press [ENTER].

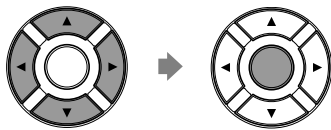

Perform operations on the screen that appears.

Checking Your Account Information



You can confirm your current account information of IDC service. You can also log out from the IDC service.

Login

Select this to log in to the IDC service. You need to enter your ID and password.

Logout

If you wish to use another IDC account or prevent the current account from being used by others, select this to log out from the IDC service.

Account Information

Select this to confirm your account information.

Subscription Status

Select this to confirm your DisklavierRadio subscription status.

1 Press [INTERNET] on the remote control.

The Internet menu screen appears.



Note:

ID and password are not required for free contents (such as free channel of DisklavierRadio).

- 2** Select “MyAccount” with the cursor buttons ([◀] [▶] [▲] [▼]), then press [ENTER].

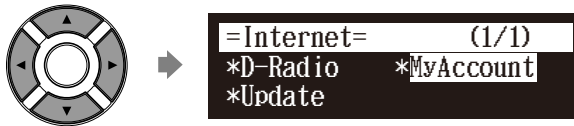

The MyAccount screen appears.



- 3** Select a desired option with the cursor buttons ([▲] [▼]), then press [ENTER].

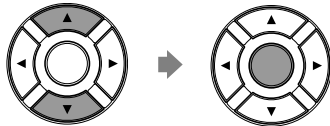

Perform operations on the screen that appears.

Updating the Disklavier Using the Internet

[INTERNET] "Update"

You can download the update program directly from the Internet and update the firmware of the Disklavier.

- 1** Press [INTERNET] on the remote control.

The Internet menu screen appears.



Internet Direct Connection (IDC)

- 2** Select “Update” with the cursor buttons ([◀] [▶] [▲] [▼]), then press [ENTER].

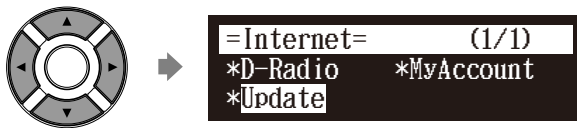

The update screen appears if there is any update program available.



You can scroll the screen up or down with the cursor buttons ([▲] [▼]).

- 3** Following the instructions on the screen, select the option with the cursor buttons ([◀] [▶] [▲] [▼]), then press [ENTER].



The download process of the update program starts.



- 4** Shut down the Disklavier with [ON/OFF] on the control unit after the download process is completed.



The update program is now prepared.

Update the firmware following the procedures in Chapter 11 “Other Settings – Updating the Disklavier” on page 121.

Setting the Disklavier for the Internet Connection

[SETUP] → "Network"

You can change various settings related to the Internet connection. In most cases, you do not have to change the default factory settings.

Information

You can confirm the information of network settings.

Use DHCP

Select the method to determine several addresses. If your router has DHCP server function, we recommend that you to select "DHCP" or "DHCP+DNS."

DNS1/DNS2

Enter the address of the primary and secondary DNS server. These settings must be made when Use DHCP is set to "DHCP+DNS" or "MANUAL."

IPAddr./SubMask/Gateway

Enter the address of the control unit, subnet mask and gateway server. These settings must be made when Use DHCP is set to "MANUAL."

Proxy/Proxy Port

Enter the name and the port number for the proxy server. These settings are necessary only when a proxy server is located in your local network.



To use the Internet connection, inquire of your Internet service provider.

Note:

For information about DNS server address, IP address, subnet mask and gateway server address, inquire of your internet service provider.

1 Press [SETUP] on the remote control.

The setup menu screen appears.



2 Select "Network" with the cursor buttons ([◀][▶][▲][▼]), then press [ENTER].



The network setting screen appears.

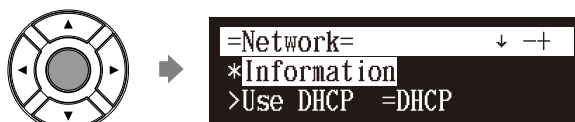

Internet Direct Connection (IDC)

- 3** Select a desired option with the cursor buttons ([◀] [▶] [▲] [▼]), then press [+ / YES] and [- / NO] to change setting.

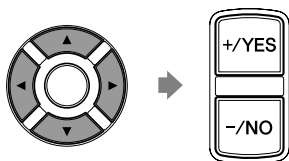

If you select “Information” on the network setting screen, the current network setting appears. To return to the network setting screen, press [ENTER] after confirming.

- 4** Press [ENTER] to complete the operation.

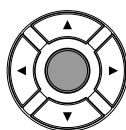

Initializing Internet Settings

[SETUP] → “Reset” →

If you want to initialize the Internet settings, first you must reset the Disklavier to its initial factory setting. However, cookies are still remain after parameter resetting. To delete cookies, perform the appropriate operation on the reset screen.



For details on cookies, see Chapter 15 “Glossary” on page 132.



See Chapter 11 “Other Settings – Resetting the Disklavier” on page 118.

Enhancing the Disklavier by Hooking Up Other Devices

Hooking Up Audio Equipment

If you connect the Disklavier to an audio system, you can hear the sound played/played back on the Disklavier from the connected audio system, and the sound played back on the connected audio system from the Disklavier.

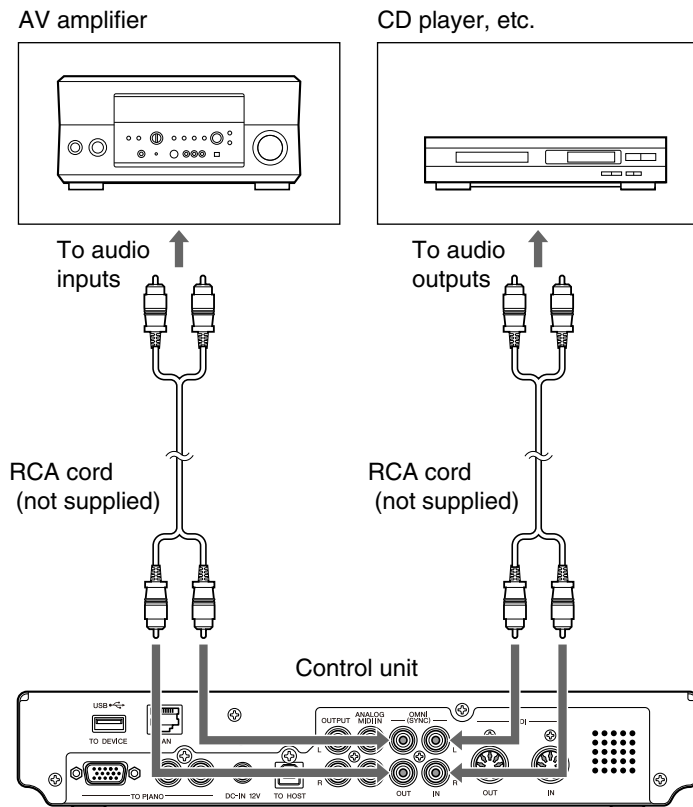

Setting the Disklavier for Audio Data Reception/Transmission

[SETUP] "Audio/O"

You can select the kind of the incoming/outgoing audio signals. The following options should be set up in advance.

OMNI IN

Selects the appropriate option to match the incoming data input to the OMNI (SYNC) IN jacks.

Auto Detect:

Select this to have the Disklavier detect the input signal automatically.

Audio: Select this when you play back audio from a connected CD player, etc. and reproduce the sound from the monitor speakers*.

OFF: Select this when you cancel the data reception from the OMNI (SYNC) IN jacks.

OMNI IN Vol

Adjust the volume of the incoming audio signals to the OMNI (SYNC) IN jacks. The volume can be set in a range of 000 to 127.

OMNI OUT

Selects the desired data to be output from the OMNI (SYNC) OUT jacks.

Output: Select this when you output the same audio signals as the ones for the monitor speakers*.

SYNC: Select this when you output the SMPTE signal used for video synchronization playback.

OFF: Select this when you cancel the data transmission from the OMNI (SYNC) OUT jacks.

OMNI OUT Vol

Adjust the volume of the outgoing audio signals to the OMNI (SYNC) OUT jacks. The volume can be set in a range of 000 to 127, or to "M-Volume."

When you set to "M-Volume", the OMNI OUT volume works with the main volume.

ANALOG MIDI IN Vol

Adjust the volume of the incoming audio signals to the ANALOG MIDI IN jacks. The volume can be set in a range of 000 to 127.

A-MIDI IN Offset

For some display devices, the video images may be displayed a little bit later than the piano playing when playing back the video synchronized software that contains the analog MIDI signal. To eliminate this delay, you can adjust the offset time that leads the actual playback of the piano. A delay is applied to the incoming analog MIDI signal. The offset time can be set in a range of -500 ms to 0 ms. Decrease this value to delay the piano playing, and increase to advance the piano playing.

* Only for models supplied with the monitor speakers.

* Only for models supplied with the monitor speakers.

Note:

"M-Volume" is the next increment on the OMNI OUT Vol setting above 127.

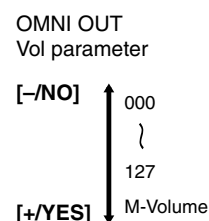

SYNC IN Offset

Adjusts the length of the offset time that leads the actual playback of the entire recording. The offset time can be set in a range of -500ms to +500ms. Decrease this value to delay the piano playing, and increase to advance the piano playing.

SYNC OUT Level

Adjusts the output level of the SMPTE signal. For normal use, the adjustment of this option is not required. If noises (synchronized signal) are output from the OUTPUT jacks during video synchronized playback, turn down the level and re-record.

OUTPUT Offset

For some speakers or digital amplifiers, the audio from the Disklavier may be output a little bit later than the acoustic piano playing. To eliminate this delay, you can adjust the offset time for the sound output. This setting is applied to the outgoing audio signal from the OUTPUT jacks and OMNI (SYNC) OUT jacks. Decrease this value to advance the sound output. The offset time can be set in a range of -100 ms to 0 ms. Decrease this value to delay the piano playing, and increase to advance the piano playing.

1 Press [SETUP] on the remote control.

The setup menu screen appears.



2 Select "AudioI/O" with the cursor buttons ([◀][▶][▲][▼]), then press [ENTER].



The audio I/O setting screen appears.



Enhancing the Disklavier by Hooking Up Other Devices

- 3** Select a desired option with the cursor buttons ([▲] [▼]), then press [+ / YES] and [- / NO] to change setting.

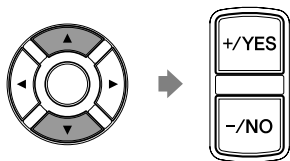

- 4** Press [ENTER] to complete the operation.

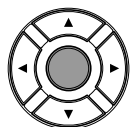

Hooking Up MIDI Devices

MIDI (an acronym for Musical Instrument Digital Interface) allows electronic device (synthesizers, etc.) to interact and work in synchronization with other MIDI compatible device. The Disklavier enables you to enjoy a variety of MIDI features by connecting a MIDI device or computer to the Disklavier's control unit.

MIDI device (sequencer, synthesizer, etc.) or computer

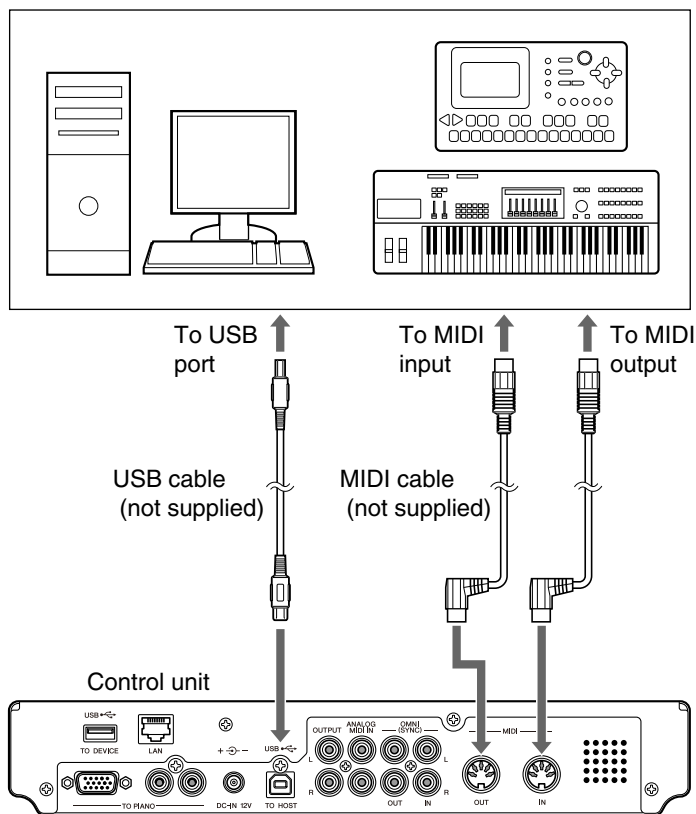

Note:

When you use the USB connection, it is required to install the USB driver to the connected device. In such a case, visit the following website and download the driver.
<http://download.yamaha.com/>

Note:

Be sure to use the commercially available MIDI cable with the L-shaped connector on the control unit end.

Setting the Disklavier for MIDI Data Reception

[SETUP] → "MIDI" →

The Disklavier can play back the MIDI data being received from the connected MIDI device as well as the software loaded or stored in the Disklavier itself. The following options should be set up in advance.

MIDI IN Port

Selects the terminal/port used for the data reception.

MIDI: Select this when the MIDI device is connected to MIDI IN terminal.

USB: Select this when the MIDI device is connected to USB port.

Piano Rcv Ch

The MIDI data consists of multi channels that are respectively assigned to a certain instrument's part. This option assigns the desired channel(s) to the piano part(s) that is (are) played back on the Disklavier's keyboard.

01 thru 16: Select the desired channel to which you assign the piano part.

1+2: Select this when the "01" and "02" channels are assigned to the piano parts.

Prg: Select the smallest number channel assigned to the piano group voice (see page 123) to be played on the Disklavier.

Prg(All): Select all channels assigned to the piano group voice (see page 123) to be played on the Disklavier.

MIDI IN Delay

When the Disklavier receives two kinds of data (strong and weak note) at the same time, the weak note sounds a little bit later than the strong one due to the characteristics of the Disklavier's mechanism. To eliminate this delay in the sound reproduction so that the notes are sounded in accurate timing at 500 milliseconds after the data reception, usually a delay is applied to the incoming MIDI data.

ON: Select this when you apply this delay to the incoming MIDI data.

OFF: Select this when you do not apply this delay.

Enhancing the Disklavier by Hooking Up Other Devices

1 Press [SETUP] on the remote control.

The setup menu screen appears.

**2** Select "MIDI" with the cursor buttons ([◀][▶][▲][▼]), then press [ENTER].

The MIDI setting screen appears.

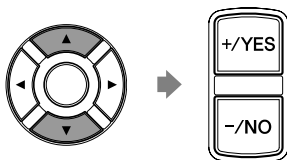
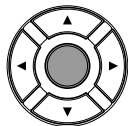
**3** Select a desired option with the cursor buttons ([▲][▼]), then press [+ / YES] and [- / NO] to change setting.**4** Press [ENTER] to complete the operation.

Setting the Disklavier for MIDI Data Transmission

[SETUP] → "MIDI"

The Disklavier can transmit the information of piano playing/ensemble part playback on the Disklavier as the MIDI data to the connected MIDI device to reproduce the sound with its sound generator, etc. or to record the MIDI data. The following options should be set up in advance.

MIDI OUT Port

Selects the terminal/port used for the data transmission.

MIDI: Select this when the MIDI device is connected to MIDI OUT terminal.

USB: Select this when the MIDI device is connected to USB port.

MIDI OUT

Selects one of the following parts to be transmitted to the connected MIDI device.

ESBL Out: Select this when you transmit the ensemble part played back on the Disklavier.

KBD Out: Select this when you transmit the piano part played on the Disklavier.

1 Press [SETUP] on the remote control.

The setup menu screen appears.



2 Select "MIDI" with the cursor buttons ([◀][▶][▲][▼]), then press [ENTER].



The MIDI setting screen appears.



Enhancing the Disklavier by Hooking Up Other Devices

- 3** Select a desired option with the cursor buttons ([▲] [▼]), then press [+ / YES] and [- / NO] to change setting.

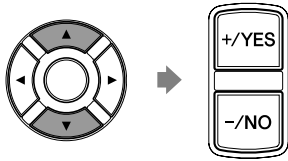

- 4** Press [ENTER] to complete the operation.



Setting the Disklavier for Keyboard Playing Data Transmission

[SETUP] → "MIDI" →

Besides the MIDI OUT options, more detailed setups for the keyboard playing data transmission are available. The following options should be set up in advance.

KBD OUT CH

Assigns the piano part to the desired channels.

01 thru 16: Select the desired channel to which you assign the piano part.

Local

Selects whether you reproduce or not the piano part playing with the Disklavier's internal tone generator.

- ON:** Select this when you reproduce the piano part with the Disklavier's internal tone generator.
- OFF:** Select this when you reproduce the song (played on the Disklavier) on the external MIDI device. This option inactivates the internal tone generator to prevent both the internal and external tone generator sound at the same time.

1 Press [SETUP] on the remote control.

The setup menu screen appears.

**2** Select "MIDI" with the cursor buttons ([◀][▶][▲][▼]), then press [ENTER].

The MIDI setting screen appears.

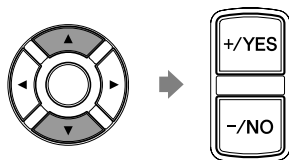
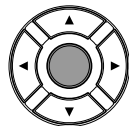
**3** Select a desired option with the cursor buttons ([▲][▼]), then press [+ / YES] and [- / NO] to change setting.**4** Press [ENTER] to complete the operation.

Tuning the Tone Generator (TG Master Tune)

[SETUP] → "M-Tune" →

The internal XG tone generator has already been tuned to match the acoustic piano (A3=440 Hz). However, you can re-tune the internal XG tone generator in accordance with the pitch of the acoustic piano by following the procedure below.

1 Press [SETUP] on the remote control.

The setup menu screen appears.



2 Select "M-Tune" with the cursor buttons ([◀][▶][▲][▼]), then press [ENTER].

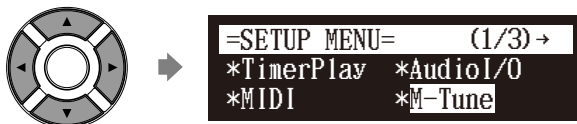

The TG Master Tune setting screen appears.

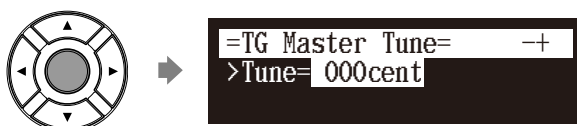

3 Playing the keyboard, press [+ / YES] and [- / NO] to tune the pitch of the internal XG tone generator.

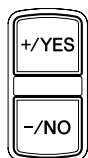

The same note will sound simultaneously on the XG tone generator's digital piano and on the acoustic piano as soon as you play the keyboard.

The pitch of the internal XG tone generator can be adjusted in a range of -50 cent to +50 cent.

- 4** Press [ENTER] to complete the operation.

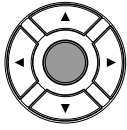

Note:

To reset to the default factory pitch settings, see Chapter 11 “Other Settings – Resetting the Disklavier” on page 118.

Assigning Frequently-used Functions to the Number Keypad on the Remote Control

[SETUP] → “Shortcut”

You can assign the number keypad of the remote control ([1] thru [9] and [0]) a series of procedures for often used functions.

■ Assigning Functions

- 1** Press [SETUP] on the remote control.

The setup menu screen appears.



- 2** Select “Shortcut” with the cursor buttons ([◀][▶][▲][▼]), then press [ENTER].



The shortcut setting screen appears.

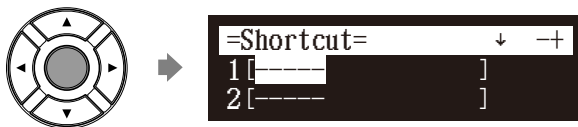

- 3** Press [▲] and [▼] to select the desired number.

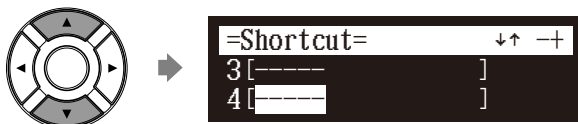

4 Press [+ / YES] and [- / NO] to select the desired function.



The following functions are available:

Option	Description
PLAY	Starts playback of songs in the selected album or playlist.
RPT	Starts repeat playback of a song or songs in the selected album or playlist.
RND	Starts playback of songs in the selected album or playlist at random.
RADIO	Starts playback of the selected DisklavierRadio channel.
BLNC	Adjusts the volume balance among the different sound sources (tone generator or audio).
POWER	Turns on and off the Disklavier.

When functions other than “POWER” are selected, the detailed setting parameter appears.

5 Press [▶] to move the cursor to the detailed setting parameter, then press [+ / YES] and [- / NO] to select the desired setting.

You can set two sets of parameter depending on the function you have selected.

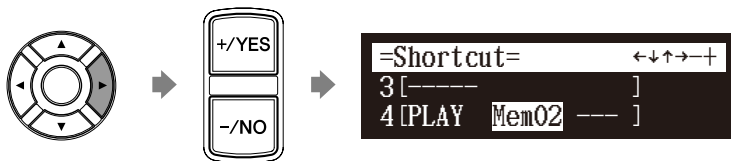

When “PLAY” is selected:

Option 1	Option 2	Description
Mem01 - Mem99	---	Starts playback from the first song in the album selected for option 1.
	001 - 999	Starts playback from the song selected for option 2 in the album selected for option 1.
Lst01 - Lst99	---	Starts playback from the first song in the playlist selected for option 1.
	001 - 999	Starts playback from the song selected for option 2 in the playlist selected for option 1.

When “RPT” is selected:

Option 1	Option 2	Description
Mem01 - Mem99	---	Starts repeat playback of all songs in the album selected for option 1 from the first song.
	001 - 999	Starts repeat playback of the song selected for option 2 in the album selected for option 1.
Lst01 - Lst99	---	Starts repeat playback of all songs in the playlist selected for option 1 from the first song.
	001 - 999	Starts repeat playback of the song selected for option 2 in the playlist selected for option 1.

When “RND” is selected:

Option	Description
Mem01 - Mem99	Starts playback of songs in the selected album at random.
Lst01 - Lst99	Starts playback of songs in the selected playlist at random.

When “RADIO” is selected:

Option	Description
CH01 - CH99	Starts playback of the selected DisklavierRadio channel.

When “BLNC” is selected:

Option 1	Option 2	Description
TG	UP	Raises the volume of the tone generator.
	DOWN	Lowers the volume of the tone generator.
AUDIO	UP	Raises the volume of the audio.
	DOWN	Lowers the volume of the audio.

When “POWER” is selected:

Details settings are not required.

6 Press [ENTER] to complete the operation.

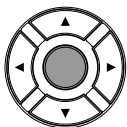

Other Settings

■ Using the Shortcut

Holding the green button on the remote control, press the corresponding number button on the number keypad to execute the assigned function.

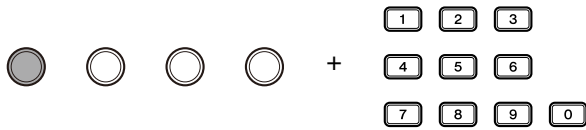

Setting the Passcode to Prevent Unauthorized Access

[SETUP] → "Passcode"

You can enter the 4-digit passcode to prevent unauthorized access from the commercially available external remote controller, or you can also set the MAC address of the external remote controller to allow it to access your Disklavier without entering the passcode.

■ Setting the Passcode

1 Press [SETUP] on the remote control.

The setup menu screen appears.



2 Select "Passcode" with the cursor buttons ([◀][▶][▲][▼]), then press [ENTER].



The passcode setting screen appears.

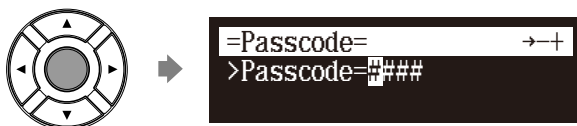

3 Press [◀] and [▶] to move the cursor left and right.

Note:

These settings are not required for the use of the remote control of this unit. In case of using an external remote controller, refer to the user's guide for that remote controller.

Note:

If changes are inappropriately made for these settings, the external remote controller may not function properly. In such cases, enter "####" to reset the passcode setting.

4 Enter the 4-digit code with the number keypad.

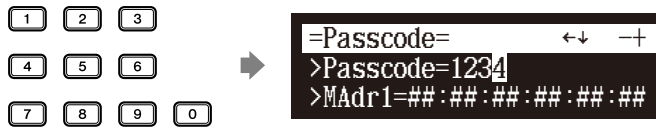

5 Press [ENTER] to complete the operation.



■ Setting the MAC Address

If you feel inconvenient to enter the passcode each time you access from the external remote controller, you can set the MAC address of the external remote controller. This will allow the external remote controller with the registered MAC address to access your Disklavier without entering the passcode.

1 With the passcode properly set, press [▼] to select "MAdr1."

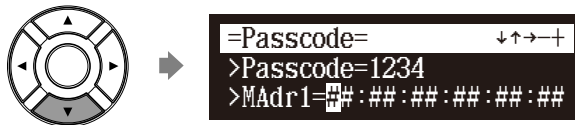

2 Press [◀] and [▶] to move the cursor left and right.



3 Enter the address with [+ / YES] and [- / NO].

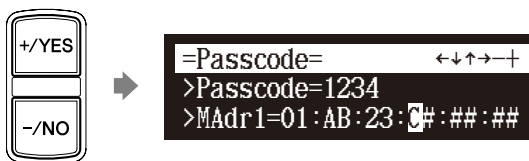

You can set up to three addresses.

4 Press [ENTER] to complete the operation.

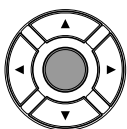

Note:

You can also use [+ / YES] and [- / NO] on the remote control, or the dial on the control unit to enter the code.

Note:

You can also use the dial on the control unit to enter the address.

Adjusting the Brightness of the Display

[SETUP] → "Display"

You can adjust the brightness of the display. You can also set the display to dim after the elapse of a certain time if there is no operation.

1 Press [SYSTEM] on the remote control.

The system menu screen appears.



2 Select "Display" with the cursor buttons ([◀][▶][▲][▼]), then press [ENTER].



The display setting screen appears.

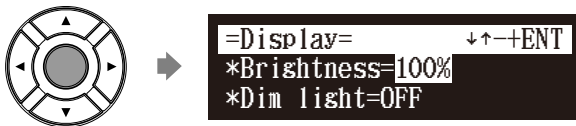

3 Press [+YES] and [-/NO] to change the brightness.

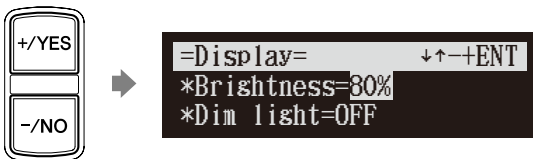

The following brightness settings are available: 40%, 60%, 80%, 100%.

- 4** To set the time for the display to dim, press [▼] to move the cursor to the dim light parameter, then press [+ / YES] and [- / NO].

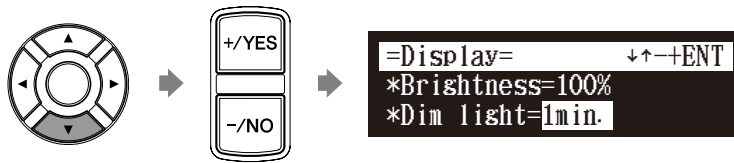

The following time settings are available: OFF, 1min, 2min, 3min, 5min, 10min, 15min, 30min, 45min, 60min.

If there is no operation for the time set above, the display dims to half the brightness of its original setting.

Note:

The brightness of the display will return to its original setting when you press any buttons, insert media, or eject media.

- 5** Press [ENTER] to complete the operation.

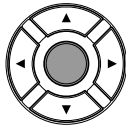

Switching the Languages for the Screen

[SYSTEM] "Language"

- 1** Press [SYSTEM] on the remote control.

The system menu screen appears.



- 2** Select "Language" with the cursor buttons ([◀][▶][▲][▼]), then press [ENTER].

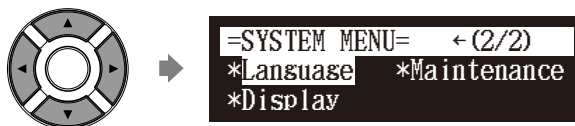

The language setting screen appears.

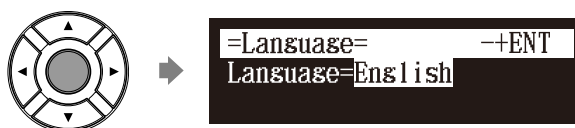

Other Settings

- 3** Press [+ / YES] and [- / NO] to select the language.

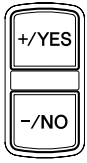

- 4** Press [ENTER].

“OK?” flashes in the first line of the screen.

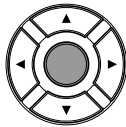

```
=Language=  OK? YES/NO
Language= Japanese
```

- 5** Press [+ / YES] to set the language, and return to the system menu screen.

Resetting the Disklavier

[SETUP] → “Reset”

If you want to return your Disklavier to its initial factory settings, follow the procedure below.

- 1** Press [SETUP] on the remote control.

The setup menu screen appears.



```
=SETUP MENU=  (1/3) →
*TimerPlay  *Audio I/O
*MIDI       *M-Tune
```

- 2** Select “Reset” with the cursor buttons ([◀] [▶] [▲] [▼]), then press [ENTER].

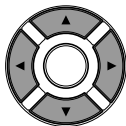

```
=SETUP MENU=  ← (3/3)
*Passcode    *Reset
```

The reset screen appears.

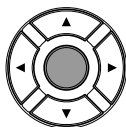

```
=Reset=  → +ENT
>Reset= Parameter
```

Important:

If you reset your Disklavier, depending upon the option you select, you may lose all parameters or all data in the internal memory, or both of these. For normal use, you do not have to reset. If you must reset your Disklavier, Yamaha strongly recommends that you backup your songs in the internal memory. However, you cannot backup your various parameter settings.



To make a backup copy of the songs which are in the internal memory, see Chapter 8 “Media Management – Making Backups of Songs” on page 90.

- 3** Press [+ / YES] and [- / NO] to select the option that you want to reset.

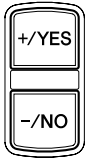

Option	Description
Parameter	Reset all parameters, excluding the clock setting and the Internet setting.
Memory	Reset the internal memory.
Factory Init.	Reset the Disklavier to its initial factory setting.
DeleteCookies	Delete the contents of all saved cookies.

- 4** Press [ENTER].

“OK?” flashes in the first line of the screen.

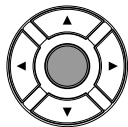

```
=Reset=      OK? YES/NO
>Reset=Factory Init.
```

- 5** Press [+ / YES] to reset, [- / NO] to cancel.



After a while, the completion message appears.
Press any button to return to the setup menu screen.

Diagnosing the Disklavier (Maintenance Mode)

[SYSTEM] "Maintenance"

The piano diagnostics may be required as the occasion demands. In such a case, follow the instructions of your Yamaha dealer and perform the following procedure.

1 Press [SYSTEM] on the remote control.

The system menu screen appears.



2 Select "Maintenance" with the cursor buttons ([◀][▶][▲][▼]), then press [ENTER].

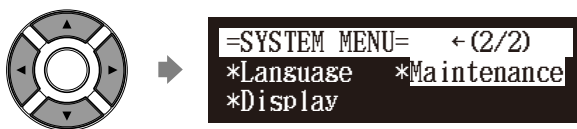

The maintenance screen appears.



3 Press [ENTER].

The maintenance options appears.

(Grand piano)

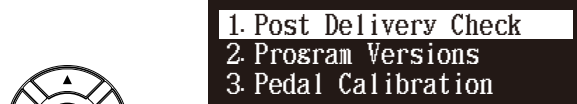

(Upright piano)



- 4** Select a desired option with the cursor buttons ([▲] [▼]), then press [ENTER].

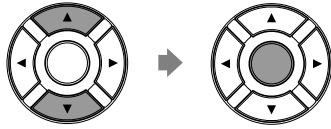

The selected option is executed.

- 5** Press [STOP] to complete the operation.



Note:

Do not execute these options with no instructions from the service personnel.

Updating the Disklavier

Shut down the Disklavier [PLAY/PAUSE] and [ON/OFF]

You can update the Disklavier firmware using update program (saved on the CD-ROM or USB flash memory, or downloaded via Internet).

You can download the update program from the following website:
<http://download.yamaha.com/>

Note:

For this operation you have to insert the CD-ROM or USB flash memory in which the update program is saved or download update program via Internet, and shut down the Disklavier.

- 1** Make sure that Disklavier is shut down.

- 2** Holding [PLAY/PAUSE] on the control unit, press [ON/OFF].



The current version information of each module appears one after the other.

Note:

Depending on the version or specification of the Disklavier, the actual indications for the version and module names may differ from ones depicted here.

- 3** Make sure that the update program is prepared, then press [ENTER] on the control unit.

The starting screen appears.



- 4** Press [ENTER] on the control unit again.

After a while, the update confirmation message of each module appears.

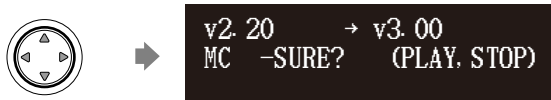

Other Settings

5 Press [PLAY/PAUSE] to start the update.

The update process of the first module takes approximately 3 minutes.

```
MC v2.20 → v3.00
DO NOT REMOVE DISK!
```

When the update of the first module completes, the following confirmation message appears.

Confirmation message of the second module

```
v2.10 → v3.00
CTRL-SURE? (PLAY, STOP)
```

Press [PLAY/PAUSE] to start the update of the second module. The update process of the second module takes approximately 3 minutes.

A total of four modules needs to be updated. Repeat this step to complete the update.

Confirmation message of the third module

```
v2.01 → v3.00
APE -SURE? (PLAY, STOP)
```

The update process of the third module takes approximately 2 minutes.

Confirmation message of the fourth module

```
v2.10 → v3.00
CSP -SURE? (PLAY, STOP)
```

The update process of the fourth module takes approximately 2 minutes.

The closing screen appears when the update for all modules completes.

```
COMPLETE
Turn OFF, Turn ON again!
```

6 Restart the Disklavier.**Important:**

DO NOT turn off this unit during update.

Important:

Be sure to update all the modules.

Internal Tone Generator Voices

The following table lists the basic voices for the internal GM/XG and TG3 tone generator.

Internal GM/XG Tone Generator Basic Voice List

Voice #	Display Name
01 Piano	
001	GrandPno
002	GrndPnoK
003	MelloGrP
004	PianoStr
005	Dream
006	BritePno
007	BritPnoK
008	E.Grand
009	EIGrPnoK
010	Det.CP80
011	EIGrPno1
012	EIGrPno2
013	HnkyTonk
014	HnkyTnkK
015	E.Piano1
016	EI.Pno1K
017	MelloEP1
018	Chor.EP1
019	HardEI.P
020	VX EI.P1
021	60sEI.P
022	E.Piano2
023	EI.Pno2K
024	Chor.EP2
025	DX Hard
026	DXLegend
027	DX Phase
028	DX+Analg
029	DXKotoEP
030	VX EI.P2
031	Harpsi.
032	Harpsi.K
033	Harpsi.2
034	Harpsi.3
035	Clavi.
036	Clavi.K
037	ClaviWah
038	PulseClv
039	PierceCl
02 ChromaticPerc	
040	Celesta
041	Glocken
042	MusicBox

Voice #	Display Name
043	Orgel
044	Vibes
045	VibesK
046	HardVibe
047	Marimba
048	MarimbaK
049	SineMrmb
050	Balafon2
051	Log Drum
052	Xylophon
053	TubulBel
054	ChrchBel
055	Carillon
056	Dulcimer
057	Dulcimr2
058	Cimbalom
059	Santur
03 Organ	
060	DrawOrgn
061	DetDrwOr
062	60sDrOr1
063	60sDrOr2
064	70sDrOr1
065	DrawOrg2
066	60sDrOr3
067	EvenBar
068	16+2"2/3
069	Organ Ba
070	70sDrOr2
071	CheezOrg
072	DrawOrg3
073	PercOrgn
074	70sPcOr1
075	DetPrcOr
076	LiteOrg
077	PercOrg2
078	RockOrgn
079	RotaryOr
080	SloRotar
081	FstRotar
082	ChrchOrg
083	ChurOrg3
084	ChurOrg2
085	NotreDam

Voice #	Display Name
086	OrgFlute
087	TrmOrgFl
088	ReedOrgn
089	Puff Org
090	Acordion
091	AccordIt
092	Harmnica
093	Harmo 2
094	TangoAcD
095	TngoAcD2
04 Guitar	
096	NylonGtr
097	NylonGt2
098	NylonGt3
099	VelGtHrm
100	Ukulele
101	SteelGtr
102	SteelGt2
103	12StrGtr
104	Nyln&Stl
105	Stl&Body
106	Mandolin
107	Jazz Gtr
108	MelloGtr
109	JazzAmp
110	CleanGtr
111	ChorusGt
112	Mute.Gtr
113	FunkGtr1
114	MuteStlG
115	FunkGtr2
116	Jazz Man
117	Ovrdrive
118	Gt.Pinch
119	Dist.Gtr
120	FeedbkGt
121	FeedbGt2
122	GtrHarmo
123	GtFeedbk
124	GtrHrmo2
05 Bass	
125	Aco.Bass
126	JazzRthm
127	VXUprght

Internal Tone Generator Voices

Voice #	Display Name
128	FngrBass
129	FingrDrk
130	FlangeBa
131	Ba&DstEG
132	FngrSlap
133	FngBass2
134	ModAlem
135	PickBass
136	MutePkBa
137	Fretless
138	Fretles2
139	Fretles3
140	Fretles4
141	SynFretl
142	Smooth
143	SlapBas1
144	ResoSlap
145	PunchThm
146	SlapBas2
147	VeloSlap
148	SynBass1
149	SynBa1Dk
150	FastResB
151	AcidBass
152	Clv Bass
153	TeknoBa
154	Oscar
155	SqrBass
156	RubberBa
157	Hammer
158	SynBass2
159	MelloSB1
160	Seq Bass
161	ClkSynBa
162	SynBa2Dk
163	SmthBa 2
164	ModulrBa
165	DX Bass
166	X WireBa
06 Strings	
167	Violin
168	SlowVln
169	Viola
170	Cello
171	Contrabs
172	Trem.Str
173	SlwTrStr
174	Susp Str
175	Pizz.Str
176	Harp
177	YangChin

Voice #	Display Name
178	Timpani
07 Ensemble	
179	Strings1
180	S.Strngs
181	SlowStr
182	ArcoStr
183	60sStrng
184	Orchestr
185	Orchstr2
186	TremOrch
187	VeloStr
188	Strings2
189	S.SlwStr
190	LegatoSt
191	Warm Str
192	Kingdom
193	70s Str
194	Str Ens3
195	Syn.Str1
196	ResoStr
197	Syn Str4
198	SS Str
199	Syn.Str2
200	ChoirAah
201	S.Choir
202	Ch.Aahs2
203	MelChoir
204	ChoirStr
205	VoiceOoh
206	SynVoice
207	SynVox2
208	Choral
209	AnaVoice
210	Orch.Hit
211	OrchHit2
212	Impact
08 Brass	
213	Trumpet
214	Trumpet2
215	BriteTrp
216	WarmTrp
217	Trombone
218	Trmbone2
219	Tuba
220	Tuba 2
221	Mute.Trp
222	Fr.Horn
223	FrHrSolo
224	FrHorn2
225	HornOrch
226	BrasSect

Voice #	Display Name
227	Tp&TbSec
228	BrssSec2
229	HiBrass
230	MelloBrs
231	SynBras1
232	QuackBr
233	RezSynBr
234	PolyBrss
235	SynBras3
236	JumpBrss
237	AnaVelBr
238	AnaBrss1
239	SynBras2
240	Soft Brs
241	SynBras4
242	ChorBrss
243	VelBras2
244	AnaBrss2
09 Reed	
245	SprnoSax
246	Alto Sax
247	Sax Sect
248	HyprAlto
249	TenorSax
250	BrthTnSx
251	SoftTenr
252	TnrSax 2
253	Bari.Sax
254	Oboe
255	Eng.Horn
256	Bassoon
257	Clarinet
10 Pipe	
258	Piccolo
259	Flute
260	Recorder
261	PanFlute
262	Bottle
263	Shakhchi
264	Whistle
265	Ocarina
11 Synth Lead	
266	SquareLd
267	Square 2
268	LMSquare
269	Hollow
270	Shmoog
271	Mellow
272	SoloSine
273	SineLead
274	Saw.Lead

Internal Tone Generator Voices

Voice #	Display Name
275	Saw 2
276	ThickSaw
277	DynaSaw
278	DigiSaw
279	Big Lead
280	HeavySyn
281	WaspySyn
282	PulseSaw
283	Dr. Lead
284	VeloLead
285	Seq Ana
286	CalliopLd
287	Pure Pad
288	Chiff Ld
289	Rubby
290	CharanLd
291	DistLead
292	WireLead
293	Voice Ld
294	SynthAah
295	VoxLead
296	Fifth Ld
297	Big Five
298	Bass &Ld
299	Big&Low
300	Fat&Prky
301	SoftWurl
12 Synth Pad	
302	NewAgePd
303	Fantasy2
304	Warm Pad
305	ThickPad
306	Soft Pad
307	SinePad
308	Horn Pad
309	RotarStr
310	PolySyPd
311	PolyPd80
312	ClickPad
313	Ana Pad
314	SquarPad
315	ChoirPad
316	Heaven2
317	ltopia
318	CC Pad
319	BowedPad
320	Glacier
321	GlassPad
322	MetalPad
323	Tine Pad
324	Pan Pad

Voice #	Display Name
325	Halo Pad
326	SweepPad
327	Shwimmer
328	Converge
329	PolarPad
330	Celstial
13 Synth Effects	
331	Rain
332	ClaviPad
333	HrmoRain
334	AfrcnWnd
335	Caribbean
336	SoundTrk
337	Prologue
338	Ancestrl
339	Crystal
340	SynDrCmp
341	Popcorn
342	TinyBell
343	RndGlock
344	GlockChi
345	ClearBel
346	ChorBell
347	SynMalet
348	SftCryst
349	LoudGlok
350	XmasBell
351	VibeBell
352	DigiBell
353	AirBells
354	BellHarp
355	Gamelmba
356	Atmosphr
357	WarmAtms
358	HollwRls
359	NylonEP
360	NylnHarp
361	Harp Vox
362	AtmosPad
363	Planet
364	Bright
365	FantaBel
366	Smokey
367	Goblins
368	GobSyn
369	50sSciFi
370	Ring Pad
371	Ritual
372	ToHeaven
373	Night
374	Glisten

Voice #	Display Name
375	BelChoir
376	Echoes
377	EchoPad2
378	Echo Pan
379	EchoBell
380	Big Pan
381	SynPiano
382	Creation
383	Stardust
384	Reso Pan
385	Sci-Fi
386	Starz
14 Ethnic	
387	Sitar
388	DetSitar
389	Sitar 2
390	Tambra
391	Tamboura
392	Banjo
393	MuteBnjo
394	Rabab
395	Gopichnt
396	Oud
397	Shamisen
398	Koto
399	T.Koto
400	Kanoon
401	Kalimba
402	Bagpipe
403	Fiddle
404	Shanai
405	Shanai2
406	Pungi
407	Hichriki
15 Percussive	
408	TnklBell
409	Bonang
410	Gender
411	Gamelan
412	S.Gamlan
413	Rama Cym
414	AsianBel
415	Agogo
416	SteelDrm
417	GlasPerc
418	ThaiBell
419	WoodBlok
420	Castanet
421	TaikoDrm
422	Gr.Cassa
423	MelodTom

Internal Tone Generator Voices

Voice #	Display Name
424	Mel Tom2
425	Real Tom
426	Rock Tom
427	Syn.Drum
428	Ana Tom
429	ElecPerc
430	RevCymb
16 Sound Effects	
431	FretNoiz
432	BrthNoiz
433	Seashore
434	Tweet
435	Telephone
436	Helicptr
437	Applause
438	Gunshot
18 SFX Voice	
450	CuttngNz
451	CtngNz2
452	Str Slap
453	Fl.KClk
454	Rain
455	Thunder
456	Wind
457	Stream
458	Bubble

Voice #	Display Name
459	Feed
460	Dog
461	Horse
462	Bird 2
463	Ghost
464	Maou
465	Tel.Dial
466	DoorSqek
467	DoorSlam
468	Scratch
469	Scratch2
470	WindChm
471	Telphon2
472	CarEngin
473	Car Stop
474	Car Pass
475	CarCrash
476	Siren
477	Train
478	Jetplane
479	Starship
480	Burst
481	Coaster
482	SbMarine
483	Laughing
484	Scream

Voice #	Display Name
485	Punch
486	Heart
487	FootStep
488	MchinGun
489	LaserGun
490	Xplosion
491	FireWork

Internal GM/XG Tone Generator Drum Voice List

Voice #	Display Name
17 Drum Kit	
439	StandKit
440	Stnd2Kit
441	Room Kit
442	Rock Kit
443	ElectKit
444	AnalgKit
445	Jazz Kit
446	BrushKit
447	ClascKit
448	SFX Kit1
449	SFX Kit2

Internal TG3 Tone Generator Basic Voice List

Voice #	Display Name
01 Piano	
001	GrandPno
002	BritePno
003	E.Grand
004	HnkyTonk
005	E.Piano1
006	E.Piano2
007	Harpsi.
008	Clavi.
02 ChromaticPerc	
009	Celesta
010	Glocken
011	MusicBox
012	Vibes
013	Marimba
014	Xylophon
015	TubulBel

Voice #	Display Name
016	Dulcimer
03 Organ	
017	DrawOrgn
018	PercOrgn
019	RockOrgn
020	ChrchrOrg
021	ReedOrgn
022	Acordion
023	Harmnica
024	TangoAcid
04 Guitar	
025	NylonGtr
026	SteelGtr
027	Jazz Gtr
028	CleanGtr
029	Mute.Gtr
030	Ovrdrive

Voice #	Display Name
031	Dist.Gtr
032	GtrHarmo
05 Bass	
033	Aco.Bass
034	FngrBass
035	PickBass
036	Fretless
037	SlapBas1
038	SlapBas2
039	SynBass1
040	SynBass2
06 Strings	
041	Violin
042	Viola
043	Cello
044	Contrabs
045	Trem.Str

Voice #	Display Name
046	Pizz.Str
047	Harp
048	Timpani
07 Ensemble	
049	Strings1
050	Strings2
051	Syn.Str1
052	Syn.Str2
053	ChoirAah
054	VoiceOoh
055	SynVoice
056	Orch.Hit
08 Brass	
057	Trumpet
058	Trombone
059	Tuba
060	Mute.Trp
061	Fr.Horn
062	BrasSect
063	SynBras1
064	SynBras2
09 Reed	
065	SprnoSax
066	Alto Sax
067	TenorSax
068	Bari.Sax
069	Oboe
070	Eng.Horn
071	Bassoon
072	Clarinet
10 Pipe	
073	Piccolo
074	Flute
075	Recorder
076	PanFlute
077	Bottle
078	Shakhchi
079	Whistle
080	Ocarina
11 Synth Lead	
081	SquareLd
082	Saw.Lead
083	CaliopLd
084	Chiff Ld
085	CharanLd
086	Voice Ld
087	Fifth Ld
088	Bass &Ld
12 Synth Pad	
089	NewAgePd
090	Warm Pad

Voice #	Display Name
091	PolySyPd
092	ChoirPad
093	BowedPad
094	MetalPad
095	Halo Pad
096	SweepPad
13 Synth Effects	
097	Rain
098	SoundTrk
099	Crystal
100	Atmosphr
101	Bright
102	Goblins
103	Echoes
104	Sci-Fi
14 Ethnic	
105	Sitar
106	Banjo
107	Shamisen
108	Koto
109	Kalimba
110	Bagpipe
111	Fiddle
112	Shanai
15 Percussive	
113	TnklBell
114	Agogo
115	SteelDrm
116	WoodBlok
117	TaikoDrm
118	MelodTom
119	Syn.Drum
120	RevCymbI
16 Sound Effects	
121	FretNoiz
122	BrthNoiz
123	Seashore
124	Tweet
125	Telephone
126	Helicptr
127	Applause
128	Gunshot

Internal TG3 Tone Generator Drum Voice List

Voice #	Display Name
17 Drum Kit	
129	StandKit

Troubleshooting

If you are having difficulty operating the Disklavier, see if any of the symptoms listed below apply to your problem and follow the recommended remedy.

Power

Symptom	Remedy
The Disklavier does not turn on.	<p>Make sure that the main switch on the power supply unit is turned on.</p> <p>Make sure that the AC power cable is securely connected to a suitable AC wall outlet.</p> <p>If the Disklavier still cannot be turned on, disconnect it from the AC wall outlet, and consult your Disklavier dealer.</p>

Control Unit

Symptom	Remedy
The control unit does not appear to work correctly.	Turn off the control unit, wait 5 seconds, then turn it back on. If the problem continues, consult your Disklavier dealer.
The control unit becomes hot.	Although the chassis of the control unit may become hot while the Disklavier is turned on (also in the standby mode), this is not a malfunction.

Remote Control

Symptom	Remedy
You cannot control the Disklavier using the remote control.	<p>Make sure that you are pointing the remote control at the control unit's remote control sensor.</p> <p>Make sure that you are within the remote control's specified operating range (approx. 5 m (16.4 ft)).</p> <p>Make sure that the remote control's batteries have been installed correctly.</p> <p>Check the condition of the remote control's batteries.</p>

Monitor Speakers*

Symptom	Remedy
No sound is heard from the monitor speakers.	<p>Make sure that the POWER switches on both monitor speakers are turned on.</p> <p>Make sure that the monitor speakers are connected to the OUTPUT jacks on the control unit with the supplied speaker cords.</p> <p>Make sure that the overall volume is adequately turned up.</p> <p>Make sure that the volume of the internal tone generator, audio and voice are adequately turned up.</p> <p>Certain model does not come with the monitor speakers. In such a case, prepare active speakers equivalent to the monitor speakers.</p>

* Only for models supplied with the monitor speakers.

Playback

Symptom	Remedy
None of the playback functions can be used.	Insert a medium that contains songs into the Disklavier.
The Disklavier does not read a song file.	The maximum number of the readable files in an album is 999. Make sure that the name of the SMF song has an extension as ".MID" or ".mid" and the E-SEQ song has ".FIL" or ".fil."
Songs are played back at the wrong tempo or in the wrong key.	Reset the tempo or transposition changes. Once the tempo or transposition have been changed, they will affect playback of all songs on an album, until another medium or album is selected, the recording standby mode is engaged, the Disklavier is turned off, or they are reset.
Songs are not played back in the normal song order.	Make sure that the random repeat mode is off.
The playback order differs from the order on another device.	The playback order depends on the recording software or other factors. Naming the file starting from numbers such as 01, 02, etc. may solve the problem.
When selecting a song using the remote control's number keypad, but the last song on the album is selected.	If a song number higher than the last song number on the album is specified, the last song will be selected.
When specifying a search time using the remote control's number keypad, but the end of the song is selected.	If a time value higher than the total length of the song is specified, the end of the song will be selected.
Some notes drop out during playback.	When a piano song is played back at a low volume, complex note trills and faint pianissimo passages sometimes drop out. In such case, increase the Disklavier's volume level.
PianoSmart™ playback cannot be performed.	Make sure that an appropriate SmartPianoSoft song, which is paired with the song on commercial CDs, is selected.
The pedals do not operate during playback.	Make sure that the pedal part is not canceled.

Tone Generator

Symptom	Remedy
The ensemble parts cannot be heard during ensemble song playback.	Make sure that the TG balance is set to an appropriate level and readjust it.
The pitch of the Disklavier and the internal tone generator do not match.	Use the TG Master Tune function to tune the internal tone generator.

Recording

Symptom	Remedy
You cannot re-record.	Re-recording is not possible on protected songs such as PianoSoft and PianoSoft-Plus songs.

Media

Symptom	Remedy
The Disklavier does not recognize a USB flash memory.	Certain USB storage devices may not function properly with the Disklavier. For a list of compatible products, please visit: www.yamaha.com/disklavier/
The Disklavier does not read a CD-R/RW disc.	The audio CD should be formatted in CD-DA, and the data CD in ISO 9660 Level1. The Disklavier may not read a CD-R/RW disc other than this format.

Connection with External Devices

Symptom	Remedy
The Disklavier cannot send or receive MIDI data with other MIDI instruments.	Make sure that the MIDI cables or USB cable are connected properly.
A MIDI loop was accidentally created when you connected a computer to the MIDI OUT terminal on your Disklavier, so that song data is sent back and forth between the computer and the Disklavier.	Configure the setting for the MIDI OUT terminal to "KBD OUT."

Video Synchronized Recording/Playback

Symptom	Remedy
Synchronized songs are not played back.	<p>Make sure that the audio channels of the DVD recorder are correctly connected to the Disklavier.</p> <p>Make sure that the input and output of the DVD recorder are correctly connected to the Disklavier.</p> <p>Make sure that the "OMNI IN" option on the Disklavier is set to "AutoDetect."</p> <p>Make sure that the "OMNI OUT" option on the Disklavier is set to "SYNC."</p>
Noises are heard during recording.	<p>Turn down the volume of the TV connected to the DVD recorder.</p> <p>Disconnect the left side connector of the RCA cord from the OMNI OUT (L) jack on the Disklavier. This will not affect the functionality of video synchronized recording.</p>
Noises are heard during playback.	The level of the synchronized signal (SMPTE) from the Disklavier may be too high. Turn down the level with the "SYNC OUT Level" option and re-record.
The piano playback is not synchronized with the video picture.	The video picture may be delayed on the projection device. Adjust the offset time with the "SYNC IN Offset" to match the piano playing and the video picture.
The beginning of the piano performance is dropped out when you play back the synchronized song.	It may take some time until the Disklavier recognizes the synchronized signal and the piano begins to play back. Select the synchronized song in advance, and then start playback on the DVD recorder. Note that you should wait for a while before playing the piano after recording begins on the DVD recorder.

Error Messages

While operating your Disklavier, an error message may appear in the display. If an error message appears, refer to the table below for an explanation of the message.

Media Selection / Playback

Error Messages	Situation	Remedy
NO MEDIA!	You selected the medium that has not been inserted.	Insert the medium or select another medium.
DIFFERENT CD!	Your CD is not paired with the selected SmartPianoSoft song.	Insert appropriate CD that is paired with the SmartPianoSoft song.

File Operation

Error Messages	Situation	Remedy
CANNOT EXECUTE. NOT ENOUGH DISK SPACE	You tried to copy a song to the medium that has no disk space.	Try another medium or delete songs on the media to make disk space.
CANNOT EXECUTE. NO DESTINATION MEDIUM	You selected the destination medium that has not been inserted when copying the album.	Insert the destination medium and select it.
DISK WRITE PROTECTED!	You tried to copy songs or albums to the medium with the protection tab set to "protected".	Set the protection tab of the medium to "unprotected".
CANNOT EXECUTE. PROTECTED FILE	You tried to copy the protected song file to the removable medium such as a USB flash memory.	You cannot copy the protected file to the removable medium.
Deleted all songs in this album	You tried to delete the album with sub folders on the external medium.	
CANNOT EXECUTE TO CREATE MORE THAN 99 ALBUMS	You tried to create a new album on the medium that already contains 99 albums.	No more than 99 albums can be created on the medium.
CANNOT EXECUTE TO CREATE MORE THAN 999 SONGS	You tried to create a new song in the album that already contains 999 songs.	No more than 999 songs can be created in the album.
CANNOT EXECUTE. SAME TITLE EXISTS	You tried to rename an album as same as the album that already exists.	Enter the different title to an album.
	You tried to rename a playlist as same as the playlist that already exists.	Enter the different title to a playlist.

Recording

Error Messages	Situation	Remedy
SELECT REC TRACK	You tried to start re-recording with no part selected.	Select the part to record before starting re-recording.

Timer Play

Error Messages	Situation	Remedy
SAME TIME EVENT EXISTS! CHANGE THE TIME	You tried to set two different programs with the same time for timer playback.	You cannot set two different program with the same time.

Glossary

This glossary provides basic definitions of terms used frequently in Disklavier manuals.

Continuous Pedal

See *"Incremental Pedal."*

Cookie

A computer data file that stores certain information for use when revisiting a website. In the case of the Disklavier, cookies are used to store ID and password for the IDC service.

DHCP

This is a standard or protocol by which IP addresses and other low-level network configuration information can be dynamically and automatically assigned each time a connection is made to the Internet.

DNS

A system that translates names of computers connected to a network to their corresponding IP addresses.

Ensemble Song

A song which contains piano parts and accompanying instrumental voices. An ensemble song contains the same left- and right-hand parts as an L/R song, and in addition, up to 13 accompanying instrument tracks. These extra tracks are played by the internal XG tone generator. The accompanying tracks may be used for acoustic bass, drums, strings, vibes, etc.

E-SEQ Song Format

A song file format developed by Yamaha for saving songs.

Floppy Disk

The magnetic storage medium that the Disklavier uses to save songs. With the optional USB floppy drive, you can use the 3.5 inch 2DD and 2HD floppy disks commonly used for computers.

Gateway

A system which links different networks or systems, and makes possible data transfer and conversion despite differing communications standards.

General MIDI (GM)

An addition to the MIDI standard that simplifies the transfer of MIDI song files between instruments of different manufacturers. A MIDI song recorded using a GM compatible tone generator should play back correctly when used with any GM compatible tone generator. The standard specifies that a GM compatible tone generator must support 24-note polyphony, 16 parts, and 128 standard voices.

Half Pedal

See *"Incremental Pedal."*

Incremental Pedal

Piano pedals are not always completely up or down and may be held somewhere in-between. Using incremental pedal data (also called continuous or half pedal data) the Disklavier precisely records the up and down movement of the piano pedals.

Internet

A huge network made up of networks, the Internet allows high-speed data transfer among computers, mobile phones and other devices.

IP Address

A string of numbers assigned to each computer connected to a network, and indicating the device's location on the network.

LAN

Short for Local Area Network, this is a data-transfer network that connects a group of computers at a single location (such as an office or home) by means of a special cable.

L/R Song

In a L/R song, the left-hand piano part is stored on track 1 (L) and the right-hand piano part is stored on track 2 (R). During playback you can cancel either part, and then play that part yourself. When recording an L/R song, you can record the two parts simultaneously or separately.

MIDI

An acronym for Musical Instrument Digital Interface. MIDI allows electronic musical instruments to communicate with each other.

Modem

A device which connects and allows data transfer between a conventional telephone line and a computer. It converts the digital signals from the computer to analog audio for sending over the phone line, and vice versa.

Piano Parts

Refer to the left- and right-hand piano parts of a song. The left-hand piano part is recorded onto track 1 and the right-hand piano part is recorded onto track 2.

PianoSoft™

The PianoSoft Disk Collection is a library of prerecorded song disks made by Yamaha specifically for use with the Disklavier.

PianoSoft-Plus™

PianoSoft-Plus disks contain Ensemble songs that can be played on the Disklavier.

Polyphony

The maximum number of voices (or sounds) that can be produced at a time from MIDI instruments.

Provider

A communications business that offers Internet connection services. In order to connect to the Internet, it is necessary to contract to a provider.

Proxy

A proxy server is a server that all computers on a local network have to go through before accessing information on the Internet. It intercepts all or designated requests to the real server to see if it can fulfill the requests itself. If not, it forwards the request to the real server. Proxy servers are used to improve performance and speed, and to filter requests, usually for security and to prevent unauthorized access to an internal network.

Router

A device for connecting multiple computer networks. For example, a router is necessary when connecting several computers in a house or office, to allow all of them access the Internet and share data. A router is usually connected between a modem and a computer, although some modems have a built-in router.

Sequencer

A sequencer can be used with the Disklavier to play back and record MIDI data.

Server

A hardware system or computer used as a central point for a network, providing access to files and services.

SmartPianoSoft™

Software made by Yamaha containing MIDI signals for playing back along with standard audio CDs.

SMF

Abbreviation for Standard MIDI File.

SMF Song Format

A song file format supported by MIDI sequencers and music software.

Song

Normally, a short piece of music with lyrics. However, for clarity in Disklavier manuals, the term is used to refer to any piece of music of any genre.

Standard MIDI File

A file of MIDI data that can be read and used by a number of different MIDI devices and computers.

Subnet Mask

A setting used to divide a large-scale network into several smaller networks.

TG Master Tune

The function that allows you to tune the internal XG tone generator, and if connected, an external tone generator simultaneously so that their tunings match that of the Disklavier.

Glossary

Tone Generator

An electronic device that can generate tones or instrument voices.

Transpose

Changing the key of a song. For example, a song in the key of C is transposed to the key of D when it is moved up two semitones.

USB

An interface for connecting an external device with plug and play. The Disklavier supplies with 2 TO DEVICE terminal with USB 1.1 standard and 1 TO HOST terminal. You can use as the external memory media if connected a USB flash memory or a USB hard disk to TO DEVICE terminal. Also the Disklavier enables you to enjoy a variety of MIDI features by connecting a computer to TO HOST terminal.

Voice

The sounds produced by a tone generator expressing various instruments.

Web Page

Refers to each individual page that makes up a website.

Website

This refers to the group of web pages that are opened together. For example, the collection of web pages whose addresses begin with "*http://www.yamaha.com/*" is referred to as the Yamaha site.

XG

Yamaha XG is an extension of the GM (General MIDI) format. Its greater polyphony, more voices, and use of effects enhances the compatibility between MIDI devices. When a song in the Yamaha XG format is played on another XG-compatible tone generator or synthesizer, it plays and sounds as the original composer/creator intended.

General Specifications

		Upright Piano	Grand Piano
Sensor System	Key Sensors	Noncontact optical fiber/grayscale shutter sensing system for 88 keys (senses the key position, keying velocity, and key releasing velocity)	
	Pedal Sensors	Damper & soft pedals: Noncontact optical position-sensing system	Damper & shift pedals: Noncontact optical position-sensing system Sostenuto pedal: Optical ON/OFF detection sensing system ¹
Drive System	Keys	DSP servo drive system (servocontrolled solenoids)	
	Pedals	DSP servo drive system (servocontrolled solenoids)	
Data Storage	Internal Memory	128 MB	
Removable Media	Compact Disc	Audio CD (CD-DA), Data CD (ISO 9660 Level1-compliant)	
	USB Flash Memory	FAT16 or FAT32 format Yamaha does not assure the operation of the commercially available USB flash memories.	
	USB Hard Disk	FAT32 format Yamaha does not assure the operation of the commercially available USB hard disks.	
	Floppy Disk	3.5" 2DD (720 KB) or 2HD (1.44 MB) floppy disk ²	
File Format		Standard MIDI File (SMF) format 0, Standard MIDI File (SMF) format 1, E-SEQ format	
Song Format		PianoSoft (Solo), PianoSoft-Plus, PianoSoft-PlusAudio, SmartPianoSoft, SmartKey (CueTIME)	
Control Unit	Drive	CD (read only)	
	Dimensions (W × H × D)	292 × 49 × 216 mm (11-1/2" × 1-15/16" × 8-1/2")	
	Weight	2.7 kg (5.95 lb)	
Monitor Speaker ³	Rated Power Output	20 W × 2 with tone and volume controls	
	Drivers	10 cm (3-15/16") woofer × 2, 2.2 cm (7/8") tweeter × 2	
	Dimensions (W × H × D)	144 × 236 × 167 mm (5-11/16" × 9-5/16" × 6-9/16")	
	Weight	4.4 kg (9.70 lb)	
Connectors	MIDI	MIDI IN, MIDI OUT	
	Audio	OUTPUT, ANALOG MIDI IN, OMNI IN, OMNI OUT	
	Others	LAN, USB (1 × TO HOST, 2 × TO DEVICE)	
Pitch Control		Set at A=440 Hz, tunable -50 to +50 cents in 1 cent increment	
Ensemble Tone	Type	Advanced Wave Memory 2 (AWM2)	
	Polyphony	32 notes (max.)	
	Ensemble Parts	16 parts	
	Voice Module Modes	XG, GM	
	Normal Voices	676 voices (480 voices can be used for playing)	
Drum Voices	21 kits (11 kits can be used for playing)		
Power Source		Local AC current, 120V, 60 Hz	
Supplied Accessories		Control unit (1), control unit suspension bracket (1) ⁴ , screw for control unit suspension bracket installation (4 × 10) (4) ⁴ , screw for control unit suspension (5 × 12) (3) ⁴ , screw for optional USB floppy disk drive installation (3 × 6) (4) ⁴ , monitor speaker (2) ³ , monitor speaker installation kit (1) ³ , speaker cord (2) ³ , remote control (1), battery for remote control (2), sample PianoSoft CD software (2), quick reference (1), operation manual (1), PianoSoft CD song list (1), Music book "50 greats for the piano" (1)	
Optional Accessories		USB floppy disk drive (UD-FD01)	

Function & Controls

Playback Functions	Media Select	Internal memory, CD, USB media (including floppy disk)
	Song Select	Cursor buttons (control unit), cursor buttons/numeric section (remote control)
	Basic Functions	Play, stop, pause
	Song Search	Reverse/forward w/sound (MIDI songs), reverse/forward w/o sound (audio songs), directly by time or measure.
	Repeat	ALL (all songs in current album), RPT (current song), RND (all songs in current album in random order), A-B
	Part Cancel	L (left), R (right), pedal
	Timer Playback	See page 35.
	Video Synchronization	See page 39.
	SmartKey™ Playback	See page 40.
	PianoSmart™ Playback	See page 40.
Playback Controls	Volume	11 levels (-10 to 0)
	Tempo	-50 to 50% in 1% increment
	Transposition	-24 to +24 semitones (2 octaves) in 1 semitone increment
	Balance (TG, Audio)	10 to 127
Recording Functions	Piano Part Recording	L/R overwrite, split
	Metronome Mode Recording	See page 48.
	Tempo Changing	See page 55.
	Video Synchronization	See page 57.
	Audio CD Synchronization	See page 61.
Piano Playing Functions	XG Voices	Approx. 500 voices
Metronome	Range	30 to 400 beats per minute
	Time Signatures	1/4, 2/4, 3/4, 4/4, 5/4, 6/4, 7/4, 8/4, 9/4
	Volume	Controllable
Utility Functions	Song	Copy, delete, rename, sort, add to playlist, type convert, time format convert, strip XP
	Album	Copy, delete, create, rename, sort, add to playlist
	Playlist	Create, delete, rename
	Backup/Restore	See pages 90 and 91.
	Floppy Disk ^{*2}	Format
Network Functions	DisklavierRadio	See pages 25 and 95.
	FromToPC	See pages 84 and 88.
	Network Update	See page 97.
Update		Firmware update with media (CD-ROM or USB flash memory) or via the Internet

Specifications are subject to change without prior notice.

Note: ^{*1} Not equipped on some models.

^{*2} Possible for optional floppy disk drive (UD-FD01).

^{*3} Only for models supplied with the monitor speakers.

^{*4} Only for grand pianos.

disklavier™ 

Appendix

Software License Notice

GNU GENERAL PUBLIC LICENSE

Version 2, June 1991

Copyright © 1989, 1991 Free Software Foundation, Inc.

59 Temple Place, Suite 330, Boston, MA 02111-1307 USA

Everyone is permitted to copy and distribute verbatim copies of this license document, but changing it is not allowed.

■ Preamble

The licenses for most software are designed to take away your freedom to share and change it. By contrast, the GNU General Public License is intended to guarantee your freedom to share and change free software — to make sure the software is free for all its users. This General Public License applies to most of the Free Software Foundation's software and to any other program whose authors commit to using it. (Some other Free Software Foundation software is covered by the GNU Library General Public License instead.) You can apply it to your programs, too.

When we speak of free software, we are referring to freedom, not price. Our General Public Licenses are designed to make sure that you have the freedom to distribute copies of free software (and charge for this service if you wish), that you receive source code or can get it if you want it, that you can change the software or use pieces of it in new free programs; and that you know you can do these things.

To protect your rights, we need to make restrictions that forbid anyone to deny you these rights or to ask you to surrender the rights. These restrictions translate to certain responsibilities for you if you distribute copies of the software, or if you modify it.

For example, if you distribute copies of such a program, whether gratis or for a fee, you must give the recipients all the rights that you have. You must make sure that they, too, receive or can get the source code. And you must show them these terms so they know their rights.

We protect your rights with two steps: (1) copyright the software, and (2) offer you this license which gives you legal permission to copy, distribute and/or modify the software.

Also, for each author's protection and ours, we want to make certain that everyone understands that there is no warranty for this free software. If the software is modified by someone else and passed on, we want its recipients to know that what they have is not the original, so that any problems introduced by others will not reflect on the original authors' reputations.

Finally, any free program is threatened constantly by software patents. We wish to avoid the danger that redistributors of a free program will individually obtain patent licenses, in effect making the program proprietary.

To prevent this, we have made it clear that any patent must be licensed for everyone's free use or not licensed at all.

The precise terms and conditions for copying, distribution and modification follow.

■ TERMS AND CONDITIONS FOR COPYING, DISTRIBUTION AND MODIFICATION

- 0 This License applies to any program or other work which contains a notice placed by the copyright holder saying it may be distributed under the terms of this General Public License. The “Program”, below, refers to any such program or work, and a “work based on the Program” means either the Program or any derivative work under copyright law: that is to say, a work containing the Program or a portion of it, either verbatim or with modifications and/or translated into another language. (Hereinafter, translation is included without limitation in the term modification.) Each licensee is addressed as “you”.

Activities other than copying, distribution and modification are not covered by this License; they are outside its scope. The act of running the Program is not restricted, and the output from the Program is covered only if its contents constitute a work based on the Program (independent of having been made by running the Program). Whether that is true depends on what the Program does.

1. You may copy and distribute verbatim copies of the Program’s source code as you receive it, in any medium, provided that you conspicuously and appropriately publish on each copy an appropriate copyright notice and disclaimer of warranty; keep intact all the notices that refer to this License and to the absence of any warranty; and give any other recipients of the Program a copy of this License along with the Program.

You may charge a fee for the physical act of transferring a copy, and you may at your option offer warranty protection in exchange for a fee.

2. You may modify your copy or copies of the Program or any portion of it, thus forming a work based on the Program, and copy and distribute such modifications or work under the terms of Section 1 above, provided that you also meet all of these conditions:
- a) You must cause the modified files to carry prominent notices stating that you changed the files and the date of any change.
 - b) You must cause any work that you distribute or publish, that in whole or in part contains or is derived from the Program or any part thereof, to be licensed as a whole at no charge to all third parties under the terms of this License.
 - c) If the modified program normally reads commands interactively when run, you must cause it, when started running for such interactive use in the most ordinary way, to print or display an announcement including an appropriate copyright notice and a notice that there is no warranty (or else, saying that you provide a warranty) and that users may redistribute the program under these conditions, and telling the user how to view a copy of this License. (Exception: if the Program itself is interactive but does not normally print such an announcement, your work based on the Program is not required to print an announcement.)

These requirements apply to the modified work as a whole. If identifiable sections of that work are not derived from the Program, and can be reasonably considered independent and separate works in themselves, then this License, and its terms, do not apply to those sections when you distribute them as separate works. But when you distribute the same sections as part of a whole which is a work based on the Program, the distribution of the whole must be on the terms of this License, whose permissions for other licensees extend to the entire whole, and thus to each and every part regardless of who wrote it.

Thus, it is not the intent of this section to claim rights or contest your rights to work written entirely by you; rather, the intent is to exercise the right to control the distribution of derivative or collective works based on the Program.

In addition, mere aggregation of another work not based on the Program with the Program (or with a work based on the Program) on a volume of a storage or distribution medium does not bring the other work under the scope of this License.

3. You may copy and distribute the Program (or a work based on it, under Section 2) in object code or executable form under the terms of Sections 1 and 2 above provided that you also do one of the following:
 - a) Accompany it with the complete corresponding machine-readable source code, which must be distributed under the terms of Sections 1 and 2 above on a medium customarily used for software interchange; or,
 - b) Accompany it with a written offer, valid for at least three years, to give any third party, for a charge no more than your cost of physically performing source distribution, a complete machine-readable copy of the corresponding source code, to be distributed under the terms of Sections 1 and 2 above on a medium customarily used for software interchange; or,
 - c) Accompany it with the information you received as to the offer to distribute corresponding source code.
(This alternative is allowed only for noncommercial distribution and only if you received the program in object code or executable form with such an offer, in accord with Subsection b above.)

The source code for a work means the preferred form of the work for making modifications to it. For an executable work, complete source code means all the source code for all modules it contains, plus any associated interface definition files, plus the scripts used to control compilation and installation of the executable.

However, as a special exception, the source code distributed need not include anything that is normally distributed (in either source or binary form) with the major components (compiler, kernel, and so on) of the operating system on which the executable runs, unless that component itself accompanies the executable.

If distribution of executable or object code is made by offering access to copy from a designated place, then offering equivalent access to copy the source code from the same place counts as distribution of the source code, even though third parties are not compelled to copy the source along with the object code.

4. You may not copy, modify, sublicense, or distribute the Program except as expressly provided under this License. Any attempt otherwise to copy, modify, sublicense or distribute the Program is void, and will automatically terminate your rights under this License. However, parties who have received copies, or rights, from you under this License will not have their licenses terminated so long as such parties remain in full compliance.
5. You are not required to accept this License, since you have not signed it. However, nothing else grants you permission to modify or distribute the Program or its derivative works. These actions are prohibited by law if you do not accept this License. Therefore, by modifying or distributing the Program (or any work based on the Program), you indicate your acceptance of this License to do so, and all its terms and conditions for copying, distributing or modifying the Program or works based on it.
6. Each time you redistribute the Program (or any work based on the Program), the recipient automatically receives a license from the original licensor to copy, distribute or modify the Program subject to these terms and conditions. You may not impose any further restrictions on the recipients' exercise of the rights granted herein. You are not responsible for enforcing compliance by third parties to this License.
7. If, as a consequence of a court judgment or allegation of patent infringement or for any other reason (not limited to patent issues), conditions are imposed on you (whether by court order, agreement or otherwise) that contradict the conditions of this License, they do not excuse you from the conditions of this License. If you cannot distribute so as to satisfy simultaneously your obligations under this License and any other pertinent obligations, then as a consequence you may not distribute the Program at all. For example, if a patent license would not permit royalty-free redistribution of the Program by all those who receive copies directly or indirectly through you, then the only way you could satisfy both it and this License would be to refrain entirely from distribution of the Program.

Software License Notice

If any portion of this section is held invalid or unenforceable under any particular circumstance, the balance of the section is intended to apply and the section as a whole is intended to apply in other circumstances.

It is not the purpose of this section to induce you to infringe any patents or other property right claims or to contest validity of any such claims; this section has the sole purpose of protecting the integrity of the free software distribution system, which is implemented by public license practices. Many people have made generous contributions to the wide range of software distributed through that system in reliance on consistent application of that system; it is up to the author/donor to decide if he or she is willing to distribute software through any other system and a licensee cannot impose that choice.

This section is intended to make thoroughly clear what is believed to be a consequence of the rest of this License.

8. If the distribution and/or use of the Program is restricted in certain countries either by patents or by copyrighted interfaces, the original copyright holder who places the Program under this License may add an explicit geographical distribution limitation excluding those countries, so that distribution is permitted only in or among countries not thus excluded. In such case, this License incorporates the limitation as if written in the body of this License.
9. The Free Software Foundation may publish revised and/or new versions of the General Public License from time to time. Such new versions will be similar in spirit to the present version, but may differ in detail to address new problems or concerns.

Each version is given a distinguishing version number. If the Program specifies a version number of this License which applies to it and “any later version”, you have the option of following the terms and conditions either of that version or of any later version published by the Free Software Foundation. If the Program does not specify a version number of this License, you may choose any version ever published by the Free Software Foundation.

10. If you wish to incorporate parts of the Program into other free programs whose distribution conditions are different, write to the author to ask for permission.
For software which is copyrighted by the Free Software Foundation, write to the Free Software Foundation; we sometimes make exceptions for this.
Our decision will be guided by the two goals of preserving the free status of all derivatives of our free software and of promoting the sharing and reuse of software generally.

NO WARRANTY

11. BECAUSE THE PROGRAM IS LICENSED FREE OF CHARGE, THERE IS NO WARRANTY FOR THE PROGRAM, TO THE EXTENT PERMITTED BY APPLICABLE LAW. EXCEPT WHEN OTHERWISE STATED IN WRITING THE COPYRIGHT HOLDERS AND/OR OTHER PARTIES PROVIDE THE PROGRAM “AS IS” WITHOUT WARRANTY OF ANY KIND, EITHER EXPRESSED OR IMPLIED, INCLUDING, BUT NOT LIMITED TO, THE IMPLIED WARRANTIES OF MERCHANTABILITY AND FITNESS FOR A PARTICULAR PURPOSE. THE ENTIRE RISK AS TO THE QUALITY AND PERFORMANCE OF THE PROGRAM IS WITH YOU. SHOULD THE PROGRAM PROVE DEFECTIVE, YOU ASSUME THE COST OF ALL NECESSARY SERVICING, REPAIR OR CORRECTION.
12. IN NO EVENT UNLESS REQUIRED BY APPLICABLE LAW OR AGREED TO IN WRITING WILL ANY COPYRIGHT HOLDER, OR ANY OTHER PARTY WHO MAY MODIFY AND/OR REDISTRIBUTE THE PROGRAM AS PERMITTED ABOVE, BE LIABLE TO YOU FOR DAMAGES, INCLUDING ANY GENERAL, SPECIAL, INCIDENTAL OR CONSEQUENTIAL DAMAGES ARISING OUT OF THE USE OR INABILITY TO USE THE PROGRAM (INCLUDING BUT NOT LIMITED TO LOSS OF DATA OR DATA BEING RENDERED INACCURATE OR LOSSES SUSTAINED BY YOU OR THIRD PARTIES OR A FAILURE OF THE PROGRAM TO OPERATE WITH ANY OTHER PROGRAMS), EVEN IF SUCH HOLDER OR OTHER PARTY HAS BEEN ADVISED OF THE POSSIBILITY OF SUCH DAMAGES.

GNU LESSER GENERAL PUBLIC LICENSE

Version 2.1, February 1999

Copyright © 1991, 1999 Free Software Foundation, Inc.

59 Temple Place, Suite 330, Boston, MA 02111-1307 USA

Everyone is permitted to copy and distribute verbatim copies of this license document, but changing it is not allowed.

[This is the first released version of the Lesser GPL. It also counts as the successor of the GNU Library Public License, version 2, hence the version number 2.1.]

■ Preamble

The licenses for most software are designed to take away your freedom to share and change it. By contrast, the GNU General Public Licenses are intended to guarantee your freedom to share and change free software — to make sure the software is free for all its users.

This license, the Lesser General Public License, applies to some specially designated software packages — typically libraries — of the Free Software Foundation and other authors who decide to use it. You can use it too, but we suggest you first think carefully about whether this license or the ordinary General Public License is the better strategy to use in any particular case, based on the explanations below.

When we speak of free software, we are referring to freedom of use, not price. Our General Public Licenses are designed to make sure that you have the freedom to distribute copies of free software (and charge for this service if you wish); that you receive source code or can get it if you want it; that you can change the software and use pieces of it in new free programs; and that you are informed that you can do these things.

To protect your rights, we need to make restrictions that forbid distributors to deny you these rights or to ask you to surrender these rights. These restrictions translate to certain responsibilities for you if you distribute copies of the library or if you modify it.

For example, if you distribute copies of the library, whether gratis or for a fee, you must give the recipients all the rights that we gave you. You must make sure that they, too, receive or can get the source code. If you link other code with the library, you must provide complete object files to the recipients, so that they can relink them with the library after making changes to the library and recompiling it. And you must show them these terms so they know their rights.

We protect your rights with a two-step method: (1) we copyright the library, and (2) we offer you this license, which gives you legal permission to copy, distribute and/or modify the library.

To protect each distributor, we want to make it very clear that there is no warranty for the free library. Also, if the library is modified by someone else and passed on, the recipients should know that what they have is not the original version, so that the original author's reputation will not be affected by problems that might be introduced by others.

Finally, software patents pose a constant threat to the existence of any free program. We wish to make sure that a company cannot effectively restrict the users of a free program by obtaining a restrictive license from a patent holder. Therefore, we insist that any patent license obtained for a version of the library must be consistent with the full freedom of use specified in this license.

Most GNU software, including some libraries, is covered by the ordinary GNU General Public License. This license, the GNU Lesser General Public License, applies to certain designated libraries, and is quite different from the ordinary General Public License. We use this license for certain libraries in order to permit linking those libraries into non-free programs.

When a program is linked with a library, whether statically or using a shared library, the combination of the two is legally speaking a combined work, a derivative of the original library. The ordinary General Public License therefore permits such linking only if the entire combination fits its criteria of freedom. The Lesser General Public License permits more lax criteria for linking other code with the library.

We call this license the “Lesser” General Public License because it does Less to protect the user’s freedom than the ordinary General Public License. It also provides other free software developers Less of an advantage over competing non-free programs. These disadvantages are the reason we use the ordinary General Public License for many libraries. However, the Lesser license provides advantages in certain special circumstances.

For example, on rare occasions, there may be a special need to encourage the widest possible use of a certain library, so that it becomes a de-facto standard. To achieve this, non-free programs must be allowed to use the library. A more frequent case is that a free library does the same job as widely used non-free libraries. In this case, there is little to gain by limiting the free library to free software only, so we use the Lesser General Public License.

In other cases, permission to use a particular library in non-free programs enables a greater number of people to use a large body of free software. For example, permission to use the GNU C Library in non-free programs enables many more people to use the whole GNU operating system, as well as its variant, the GNU/Linux operating system.

Although the Lesser General Public License is Less protective of the users’ freedom, it does ensure that the user of a program that is linked with the Library has the freedom and the wherewithal to run that program using a modified version of the Library.

The precise terms and conditions for copying, distribution and modification follow. Pay close attention to the difference between a “work based on the library” and a “work that uses the library”. The former contains code derived from the library, whereas the latter must be combined with the library in order to run.

■ TERMS AND CONDITIONS FOR COPYING, DISTRIBUTION AND MODIFICATION

0. This License Agreement applies to any software library or other program which contains a notice placed by the copyright holder or other authorized party saying it may be distributed under the terms of this Lesser General Public License (also called “this License”). Each licensee is addressed as “you”.

A “library” means a collection of software functions and/or data prepared so as to be conveniently linked with application programs (which use some of those functions and data) to form executables.

The “Library”, below, refers to any such software library or work which has been distributed under these terms. A “work based on the Library” means either the Library or any derivative work under copyright law: that is to say, a work containing the Library or a portion of it, either verbatim or with modifications and/or translated straightforwardly into another language. (Hereinafter, translation is included without limitation in the term “modification”.)

“Source code” for a work means the preferred form of the work for making modifications to it. For a library, complete source code means all the source code for all modules it contains, plus any associated interface definition files, plus the scripts used to control compilation and installation of the library.

Activities other than copying, distribution and modification are not covered by this License; they are outside its scope. The act of running a program using the Library is not restricted, and output from such a program is covered only if its contents constitute a work based on the Library (independent of the use of the Library in a tool for writing it). Whether that is true depends on what the Library does and what the program that uses the Library does.

1. You may copy and distribute verbatim copies of the Library's complete source code as you receive it, in any medium, provided that you conspicuously and appropriately publish on each copy an appropriate copyright notice and disclaimer of warranty; keep intact all the notices that refer to this License and to the absence of any warranty; and distribute a copy of this License along with the Library.

You may charge a fee for the physical act of transferring a copy, and you may at your option offer warranty protection in exchange for a fee.

2. You may modify your copy or copies of the Library or any portion of it, thus forming a work based on the Library, and copy and distribute such modifications or work under the terms of Section 1 above, provided that you also meet all of these conditions:
 - a) The modified work must itself be a software library.
 - b) You must cause the files modified to carry prominent notices stating that you changed the files and the date of any change.
 - c) You must cause the whole of the work to be licensed at no charge to all third parties under the terms of this License.
 - d) If a facility in the modified Library refers to a function or a table of data to be supplied by an application program that uses the facility, other than as an argument passed when the facility is invoked, then you must make a good faith effort to ensure that, in the event an application does not supply such function or table, the facility still operates, and performs whatever part of its purpose remains meaningful.

(For example, a function in a library to compute square roots has a purpose that is entirely well-defined independent of the application. Therefore, Subsection 2d requires that any application-supplied function or table used by this function must be optional: if the application does not supply it, the square root function must still compute square roots.)

These requirements apply to the modified work as a whole. If identifiable sections of that work are not derived from the Library, and can be reasonably considered independent and separate works in themselves, then this License, and its terms, do not apply to those sections when you distribute them as separate works. But when you distribute the same sections as part of a whole which is a work based on the Library, the distribution of the whole must be on the terms of this License, whose permissions for other licensees extend to the entire whole, and thus to each and every part regardless of who wrote it.

Thus, it is not the intent of this section to claim rights or contest your rights to work written entirely by you; rather, the intent is to exercise the right to control the distribution of derivative or collective works based on the Library.

In addition, mere aggregation of another work not based on the Library with the Library (or with a work based on the Library) on a volume of a storage or distribution medium does not bring the other work under the scope of this License.

3. You may opt to apply the terms of the ordinary GNU General Public License instead of this License to a given copy of the Library. To do this, you must alter all the notices that refer to this License, so that they refer to the ordinary GNU General Public License, version 2, instead of to this License. (If a newer version than version 2 of the ordinary GNU General Public License has appeared, then you can specify that version instead if you wish.) Do not make any other change in these notices.

Once this change is made in a given copy, it is irreversible for that copy, so the ordinary GNU General Public License applies to all subsequent copies and derivative works made from that copy.

This option is useful when you wish to copy part of the code of the Library into a program that is not a library.

Software License Notice

4. You may copy and distribute the Library (or a portion or derivative of it, under Section 2) in object code or executable form under the terms of Sections 1 and 2 above provided that you accompany it with the complete corresponding machine-readable source code, which must be distributed under the terms of Sections 1 and 2 above on a medium customarily used for software interchange.

If distribution of object code is made by offering access to copy from a designated place, then offering equivalent access to copy the source code from the same place satisfies the requirement to distribute the source code, even though third parties are not compelled to copy the source along with the object code.

5. A program that contains no derivative of any portion of the Library, but is designed to work with the Library by being compiled or linked with it, is called a “work that uses the Library”. Such a work, in isolation, is not a derivative work of the Library, and therefore falls outside the scope of this License.

However, linking a “work that uses the Library” with the Library creates an executable that is a derivative of the Library (because it contains portions of the Library), rather than a “work that uses the library”. The executable is therefore covered by this License. Section 6 states terms for distribution of such executables.

When a “work that uses the Library” uses material from a header file that is part of the Library, the object code for the work may be a derivative work of the Library even though the source code is not. Whether this is true is especially significant if the work can be linked without the Library, or if the work is itself a library. The threshold for this to be true is not precisely defined by law.

If such an object file uses only numerical parameters, data structure layouts and accessors, and small macros and small inline functions (ten lines or less in length), then the use of the object file is unrestricted, regardless of whether it is legally a derivative work. (Executables containing this object code plus portions of the Library will still fall under Section 6.)

Otherwise, if the work is a derivative of the Library, you may distribute the object code for the work under the terms of Section 6. Any executables containing that work also fall under Section 6, whether or not they are linked directly with the Library itself.

6. As an exception to the Sections above, you may also combine or link a “work that uses the Library” with the Library to produce a work containing portions of the Library, and distribute that work under terms of your choice, provided that the terms permit modification of the work for the customer’s own use and reverse engineering for debugging such modifications.

You must give prominent notice with each copy of the work that the Library is used in it and that the Library and its use are covered by this License. You must supply a copy of this License. If the work during execution displays copyright notices, you must include the copyright notice for the Library among them, as well as a reference directing the user to the copy of this License.

Also, you must do one of these things:

- a) Accompany the work with the complete corresponding machine-readable source code for the Library including whatever changes were used in the work (which must be distributed under Sections 1 and 2 above); and, if the work is an executable linked with the Library, with the complete machine-readable “work that uses the Library”, as object code and/or source code, so that the user can modify the Library and then relink to produce a modified executable containing the modified Library. (It is understood that the user who changes the contents of definitions files in the Library will not necessarily be able to recompile the application to use the modified definitions.)
- b) Use a suitable shared library mechanism for linking with the Library. A suitable mechanism is one that (1) uses at run time a copy of the library already present on the user’s computer system, rather than copying library functions into the executable, and (2) will operate properly with a modified version of the library, if the user installs one, as long as the modified version is interface-compatible with the version that the work was made with.

- c) Accompany the work with a written offer, valid for at least three years, to give the same user the materials specified in Subsection 6a, above, for a charge no more than the cost of performing this distribution.
- d) If distribution of the work is made by offering access to copy from a designated place, offer equivalent access to copy the above specified materials from the same place.
- e) Verify that the user has already received a copy of these materials or that you have already sent this user a copy.

For an executable, the required form of the “work that uses the Library” must include any data and utility programs needed for reproducing the executable from it.

However, as a special exception, the materials to be distributed need not include anything that is normally distributed (in either source or binary form) with the major components (compiler, kernel, and so on) of the operating system on which the executable runs, unless that component itself accompanies the executable.

It may happen that this requirement contradicts the license restrictions of other proprietary libraries that do not normally accompany the operating system. Such a contradiction means you cannot use both them and the Library together in an executable that you distribute.

7. You may place library facilities that are a work based on the Library side-by-side in a single library together with other library facilities not covered by this License, and distribute such a combined library, provided that the separate distribution of the work based on the Library and of the other library facilities is otherwise permitted, and provided that you do these two things:
 - a) Accompany the combined library with a copy of the same work based on the Library, uncombined with any other library facilities. This must be distributed under the terms of the Sections above.
 - b) Give prominent notice with the combined library of the fact that part of it is a work based on the Library, and explaining where to find the accompanying uncombined form of the same work.
8. You may not copy, modify, sublicense, link with, or distribute the Library except as expressly provided under this License. Any attempt otherwise to copy, modify, sublicense, link with, or distribute the Library is void, and will automatically terminate your rights under this License. However, parties who have received copies, or rights, from you under this License will not have their licenses terminated so long as such parties remain in full compliance.
9. You are not required to accept this License, since you have not signed it. However, nothing else grants you permission to modify or distribute the Library or its derivative works. These actions are prohibited by law if you do not accept this License. Therefore, by modifying or distributing the Library (or any work based on the Library), you indicate your acceptance of this License to do so, and all its terms and conditions for copying, distributing or modifying the Library or works based on it.
10. Each time you redistribute the Library (or any work based on the Library), the recipient automatically receives a license from the original licensor to copy, distribute, link with or modify the Library subject to these terms and conditions. You may not impose any further restrictions on the recipients’ exercise of the rights granted herein. You are not responsible for enforcing compliance by third parties with this License.
11. If, as a consequence of a court judgment or allegation of patent infringement or for any other reason (not limited to patent issues), conditions are imposed on you (whether by court order, agreement or otherwise) that contradict the conditions of this License, they do not excuse you from the conditions of this License. If you cannot distribute so as to satisfy simultaneously your obligations under this License and any other pertinent obligations, then as a consequence you may not distribute the Library at all. For example, if a patent license would not permit royalty-free redistribution of the Library by all those who receive copies directly or indirectly through you, then the only way you could satisfy both it and this License would be to refrain entirely from distribution of the Library.

Software License Notice

If any portion of this section is held invalid or unenforceable under any particular circumstance, the balance of the section is intended to apply, and the section as a whole is intended to apply in other circumstances.

It is not the purpose of this section to induce you to infringe any patents or other property right claims or to contest validity of any such claims; this section has the sole purpose of protecting the integrity of the free software distribution system which is implemented by public license practices. Many people have made generous contributions to the wide range of software distributed through that system in reliance on consistent application of that system; it is up to the author/donor to decide if he or she is willing to distribute software through any other system and a licensee cannot impose that choice.

This section is intended to make thoroughly clear what is believed to be a consequence of the rest of this License.

12. If the distribution and/or use of the Library is restricted in certain countries either by patents or by copyrighted interfaces, the original copyright holder who places the Library under this License may add an explicit geographical distribution limitation excluding those countries, so that distribution is permitted only in or among countries not thus excluded. In such case, this License incorporates the limitation as if written in the body of this License.

13. The Free Software Foundation may publish revised and/or new versions of the Lesser General Public License from time to time. Such new versions will be similar in spirit to the present version, but may differ in detail to address new problems or concerns.

Each version is given a distinguishing version number. If the Library specifies a version number of this License which applies to it and “any later version”, you have the option of following the terms and conditions either of that version or of any later version published by the Free Software Foundation. If the Library does not specify a license version number, you may choose any version ever published by the Free Software Foundation.

14. If you wish to incorporate parts of the Library into other free programs whose distribution conditions are incompatible with these, write to the author to ask for permission. For software which is copyrighted by the Free Software Foundation, write to the Free Software Foundation; we sometimes make exceptions for this. Our decision will be guided by the two goals of preserving the free status of all derivatives of our free software and of promoting the sharing and reuse of software generally.

NO WARRANTY

15. BECAUSE THE LIBRARY IS LICENSED FREE OF CHARGE, THERE IS NO WARRANTY FOR THE LIBRARY, TO THE EXTENT PERMITTED BY APPLICABLE LAW. EXCEPT WHEN OTHERWISE STATED IN WRITING THE COPYRIGHT HOLDERS AND/OR OTHER PARTIES PROVIDE THE LIBRARY “AS IS” WITHOUT WARRANTY OF ANY KIND, EITHER EXPRESSED OR IMPLIED, INCLUDING, BUT NOT LIMITED TO, THE IMPLIED WARRANTIES OF MERCHANTABILITY AND FITNESS FOR A PARTICULAR PURPOSE. THE ENTIRE RISK AS TO THE QUALITY AND PERFORMANCE OF THE LIBRARY IS WITH YOU. SHOULD THE LIBRARY PROVE DEFECTIVE, YOU ASSUME THE COST OF ALL NECESSARY SERVICING, REPAIR OR CORRECTION.

16. IN NO EVENT UNLESS REQUIRED BY APPLICABLE LAW OR AGREED TO IN WRITING WILL ANY COPYRIGHT HOLDER, OR ANY OTHER PARTY WHO MAY MODIFY AND/OR REDISTRIBUTE THE LIBRARY AS PERMITTED ABOVE, BE LIABLE TO YOU FOR DAMAGES, INCLUDING ANY GENERAL, SPECIAL, INCIDENTAL OR CONSEQUENTIAL DAMAGES ARISING OUT OF THE USE OR INABILITY TO USE THE LIBRARY (INCLUDING BUT NOT LIMITED TO LOSS OF DATA OR DATA BEING RENDERED INACCURATE OR LOSSES SUSTAINED BY YOU OR THIRD PARTIES OR A FAILURE OF THE LIBRARY TO OPERATE WITH ANY OTHER SOFTWARE), EVEN IF SUCH HOLDER OR OTHER PARTY HAS BEEN ADVISED OF THE POSSIBILITY OF SUCH DAMAGES.

expat

Copyright © 1998, 1999, 2000 Thai Open Source Software Center Ltd and Clark Cooper
Copyright © 2001, 2002, 2003 Expat maintainers.

Permission is hereby granted, free of charge, to any person obtaining a copy of this software and associated documentation files (the “Software”), to deal in the Software without restriction, including without limitation the rights to use, copy, modify, merge, publish, distribute, sublicense, and/or sell copies of the Software, and to permit persons to whom the Software is furnished to do so, subject to the following conditions:

The above copyright notice and this permission notice shall be included in all copies or substantial portions of the Software.

THE SOFTWARE IS PROVIDED “AS IS”, WITHOUT WARRANTY OF ANY KIND, EXPRESS OR IMPLIED, INCLUDING BUT NOT LIMITED TO THE WARRANTIES OF MERCHANTABILITY, FITNESS FOR A PARTICULAR PURPOSE AND NONINFRINGEMENT.

IN NO EVENT SHALL THE AUTHORS OR COPYRIGHT HOLDERS BE LIABLE FOR ANY CLAIM, DAMAGES OR OTHER LIABILITY, WHETHER IN AN ACTION OF CONTRACT, TORT OR OTHERWISE, ARISING FROM, OUT OF OR IN CONNECTION WITH THE SOFTWARE OR THE USE OR OTHER DEALINGS IN THE SOFTWARE.

glibc

This file contains the copying permission notices for various files in the GNU C Library distribution that have copyright owners other than the Free Software Foundation. These notices all require that a copy of the notice be included in the accompanying documentation and be distributed with binary distributions of the code, so be sure to include this file along with any binary distributions derived from the GNU C Library.

All code incorporated from 4.4 BSD is distributed under the following license:

Copyright © 1991 Regents of the University of California. All rights reserved.

Redistribution and use in source and binary forms, with or without modification, are permitted provided that the following conditions are met:

1. Redistributions of source code must retain the above copyright notice, this list of conditions and the following disclaimer.
2. Redistributions in binary form must reproduce the above copyright notice, this list of conditions and the following disclaimer in the documentation and/or other materials provided with the distribution.
3. [This condition was removed.]
4. Neither the name of the University nor the names of its contributors may be used to endorse or promote products derived from this software without specific prior written permission.

Software License Notice

THIS SOFTWARE IS PROVIDED BY THE REGENTS AND CONTRIBUTORS "AS IS" AND ANY EXPRESS OR IMPLIED WARRANTIES, INCLUDING, BUT NOT LIMITED TO, THE IMPLIED WARRANTIES OF MERCHANTABILITY AND FITNESS FOR A PARTICULAR PURPOSE ARE DISCLAIMED. IN NO EVENT SHALL THE REGENTS OR CONTRIBUTORS BE LIABLE FOR ANY DIRECT, INDIRECT, INCIDENTAL, SPECIAL, EXEMPLARY, OR CONSEQUENTIAL DAMAGES (INCLUDING, BUT NOT LIMITED TO, PROCUREMENT OF SUBSTITUTE GOODS OR SERVICES; LOSS OF USE, DATA, OR PROFITS; OR BUSINESS INTERRUPTION) HOWEVER CAUSED AND ON ANY THEORY OF LIABILITY, WHETHER IN CONTRACT, STRICT LIABILITY, OR TORT (INCLUDING NEGLIGENCE OR OTHERWISE) ARISING IN ANY WAY OUT OF THE USE OF THIS SOFTWARE, EVEN IF ADVISED OF THE POSSIBILITY OF SUCH DAMAGE.

The DNS resolver code, taken from BIND 4.9.5, is copyrighted both by UC Berkeley and by Digital Equipment Corporation. The DEC portions are under the following license:

Portions Copyright © 1993 by Digital Equipment Corporation.

Permission to use, copy, modify, and distribute this software for any purpose with or without fee is hereby granted, provided that the above copyright notice and this permission notice appear in all copies, and that the name of Digital Equipment Corporation not be used in advertising or publicity pertaining to distribution of the document or software without specific, written prior permission.

THE SOFTWARE IS PROVIDED "AS IS" AND DIGITAL EQUIPMENT CORP. DISCLAIMS ALL WARRANTIES WITH REGARD TO THIS SOFTWARE, INCLUDING ALL IMPLIED WARRANTIES OF MERCHANTABILITY AND FITNESS. IN NO EVENT SHALL DIGITAL EQUIPMENT CORPORATION BE LIABLE FOR ANY SPECIAL, DIRECT, INDIRECT, OR CONSEQUENTIAL DAMAGES OR ANY DAMAGES WHATSOEVER RESULTING FROM LOSS OF USE, DATA OR PROFITS, WHETHER IN AN ACTION OF CONTRACT, NEGLIGENCE OR OTHER TORTIOUS ACTION, ARISING OUT OF OR IN CONNECTION WITH THE USE OR PERFORMANCE OF THIS SOFTWARE.

The Sun RPC support (from rpcsrc-4.0) is covered by the following license:

Copyright © 1984, Sun Microsystems, Inc.

Sun RPC is a product of Sun Microsystems, Inc. and is provided for unrestricted use provided that this legend is included on all tape media and as a part of the software program in whole or part. Users may copy or modify Sun RPC without charge, but are not authorized to license or distribute it to anyone else except as part of a product or program developed by the user.

SUN RPC IS PROVIDED AS IS WITH NO WARRANTIES OF ANY KIND INCLUDING THE WARRANTIES OF DESIGN, MERCHANTABILITY AND FITNESS FOR A PARTICULAR PURPOSE, OR ARISING FROM A COURSE OF DEALING, USAGE OR TRADE PRACTICE.

Sun RPC is provided with no support and without any obligation on the part of Sun Microsystems, Inc. to assist in its use, correction, modification or enhancement.

SUN MICROSYSTEMS, INC. SHALL HAVE NO LIABILITY WITH RESPECT TO THE INFRINGEMENT OF COPYRIGHTS, TRADE SECRETS OR ANY PATENTS BY SUN RPC OR ANY PART THEREOF.

In no event will Sun Microsystems, Inc. be liable for any lost revenue or profits or other special, indirect and consequential damages, even if Sun has been advised of the possibility of such damages.

The following CMU license covers some of the support code for Mach, derived from Mach 3.0:

Mach Operating System

Copyright © 1991, 1990, 1989 Carnegie Mellon University All Rights Reserved.

Permission to use, copy, modify and distribute this software and its documentation is hereby granted, provided that both the copyright notice and this permission notice appear in all copies of the software, derivative works or modified versions, and any portions thereof, and that both notices appear in supporting documentation.

CARNEGIE MELLON ALLOWS FREE USE OF THIS SOFTWARE IN ITS “AS IS” CONDITION. CARNEGIE MELLON DISCLAIMS ANY LIABILITY OF ANY KIND FOR ANY DAMAGES WHATSOEVER RESULTING FROM THE USE OF THIS SOFTWARE.

Carnegie Mellon requests users of this software to return to

Software Distribution Coordinator
 School of Computer Science
 Carnegie Mellon University
 Pittsburgh PA 15213-3890

or Software.Distribution@CS.CMU.EDU any improvements or extensions that they make and grant Carnegie Mellon the rights to redistribute these changes.

The file if_ppp.h is under the following CMU license:

Redistribution and use in source and binary forms, with or without modification, are permitted provided that the following conditions are met:

1. Redistributions of source code must retain the above copyright notice, this list of conditions and the following disclaimer.
2. Redistributions in binary form must reproduce the above copyright notice, this list of conditions and the following disclaimer in the documentation and/or other materials provided with the distribution.
3. Neither the name of the University nor the names of its contributors may be used to endorse or promote products derived from this software without specific prior written permission.

THIS SOFTWARE IS PROVIDED BY CARNEGIE MELLON UNIVERSITY AND CONTRIBUTORS “AS IS” AND ANY EXPRESS OR IMPLIED WARRANTIES, INCLUDING, BUT NOT LIMITED TO, THE IMPLIED WARRANTIES OF MERCHANTABILITY AND FITNESS FOR A PARTICULAR PURPOSE ARE DISCLAIMED. IN NO EVENT SHALL THE UNIVERSITY OR CONTRIBUTORS BE LIABLE FOR ANY DIRECT, INDIRECT, INCIDENTAL, SPECIAL, EXEMPLARY, OR CONSEQUENTIAL DAMAGES (INCLUDING, BUT NOT LIMITED TO, PROCUREMENT OF SUBSTITUTE GOODS OR SERVICES; LOSS OF USE, DATA, OR PROFITS; OR BUSINESS INTERRUPTION) HOWEVER CAUSED AND ON ANY THEORY OF LIABILITY, WHETHER IN CONTRACT, STRICT LIABILITY, OR TORT (INCLUDING NEGLIGENCE OR OTHERWISE) ARISING IN ANY WAY OUT OF THE USE OF THIS SOFTWARE, EVEN IF ADVISED OF THE POSSIBILITY OF SUCH DAMAGE.

The following license covers the files from Intel’s “Highly Optimized Mathematical Functions for Itanium” collection:

Intel License Agreement
 Copyright © 2000, Intel Corporation
 All rights reserved.

Redistribution and use in source and binary forms, with or without modification, are permitted provided that the following conditions are met:

- * Redistributions of source code must retain the above copyright notice, this list of conditions and the following disclaimer.
- * Redistributions in binary form must reproduce the above copyright notice, this list of conditions and the following disclaimer in the documentation and/or other materials provided with the distribution.
- * The name of Intel Corporation may not be used to endorse or promote products derived from this software without specific prior written permission.

Software License Notice

THIS SOFTWARE IS PROVIDED BY THE COPYRIGHT HOLDERS AND CONTRIBUTORS "AS IS" AND ANY EXPRESS OR IMPLIED WARRANTIES, INCLUDING, BUT NOT LIMITED TO, THE IMPLIED WARRANTIES OF MERCHANTABILITY AND FITNESS FOR A PARTICULAR PURPOSE ARE DISCLAIMED. IN NO EVENT SHALL INTEL OR CONTRIBUTORS BE LIABLE FOR ANY DIRECT, INDIRECT, INCIDENTAL, SPECIAL, EXEMPLARY, OR CONSEQUENTIAL DAMAGES (INCLUDING, BUT NOT LIMITED TO, PROCUREMENT OF SUBSTITUTE GOODS OR SERVICES; LOSS OF USE, DATA, OR PROFITS; OR BUSINESS INTERRUPTION) HOWEVER CAUSED AND ON ANY THEORY OF LIABILITY, WHETHER IN CONTRACT, STRICT LIABILITY, OR TORT (INCLUDING NEGLIGENCE OR OTHERWISE) ARISING IN ANY WAY OUT OF THE USE OF THIS SOFTWARE, EVEN IF ADVISED OF THE POSSIBILITY OF SUCH DAMAGE.

The files `inet/getnameinfo.c` and `sysdeps/posix/getaddrinfo.c` are copyright © by Craig Metz and are distributed under the following license:

The Inner Net License, Version 2.00

The author(s) grant permission for redistribution and use in source and binary forms, with or without modification, of the software and documentation provided that the following conditions are met:

0. If you receive a version of the software that is specifically labelled as not being for redistribution (check the version message and/or README), you are not permitted to redistribute that version of the software in any way or form.
1. All terms of the all other applicable copyrights and licenses must be followed.
2. Redistributions of source code must retain the authors' copyright notice(s), this list of conditions, and the following disclaimer.
3. Redistributions in binary form must reproduce the authors' copyright notice(s), this list of conditions, and the following disclaimer in the documentation and/or other materials provided with the distribution.
4. [The copyright holder has authorized the removal of this clause.]
5. Neither the name(s) of the author(s) nor the names of its contributors may be used to endorse or promote products derived from this software without specific prior written permission.

THIS SOFTWARE IS PROVIDED BY ITS AUTHORS AND CONTRIBUTORS "AS IS" AND ANY EXPRESS OR IMPLIED WARRANTIES, INCLUDING, BUT NOT LIMITED TO, THE IMPLIED WARRANTIES OF MERCHANTABILITY AND FITNESS FOR A PARTICULAR PURPOSE ARE DISCLAIMED. IN NO EVENT SHALL THE AUTHORS OR CONTRIBUTORS BE LIABLE FOR ANY DIRECT, INDIRECT, INCIDENTAL, SPECIAL, EXEMPLARY, OR CONSEQUENTIAL DAMAGES (INCLUDING, BUT NOT LIMITED TO, PROCUREMENT OF SUBSTITUTE GOODS OR SERVICES; LOSS OF USE, DATA, OR PROFITS; OR BUSINESS INTERRUPTION) HOWEVER CAUSED AND ON ANY THEORY OF LIABILITY, WHETHER IN CONTRACT, STRICT LIABILITY, OR TORT (INCLUDING NEGLIGENCE OR OTHERWISE) ARISING IN ANY WAY OUT OF THE USE OF THIS SOFTWARE, EVEN IF ADVISED OF THE POSSIBILITY OF SUCH DAMAGE.

If these license terms cause you a real problem, contact the author.

libcap

Unless otherwise *explicitly* stated, the following text describes the licensed conditions under which the contents of this libcap release may be used and distributed:

Redistribution and use in source and binary forms of libcap, with or without modification, are permitted provided that the following conditions are met:

1. Redistributions of source code must retain any existing copyright notice, and this entire permission notice in its entirety, including the disclaimer of warranties.
2. Redistributions in binary form must reproduce all prior and current copyright notices, this list of conditions, and the following disclaimer in the documentation and/or other materials provided with the distribution.
3. The name of any author may not be used to endorse or promote products derived from this software without their specific prior written permission.

ALTERNATIVELY, this product may be distributed under the terms of the GNU General Public License, in which case the provisions of the GNU GPL are required INSTEAD OF the above restrictions. (This clause is necessary due to a potential conflict between the GNU GPL and the restrictions contained in a BSD-style copyright.)

THIS SOFTWARE IS PROVIDED "AS IS" AND ANY EXPRESS OR IMPLIED WARRANTIES, INCLUDING, BUT NOT LIMITED TO, THE IMPLIED WARRANTIES OF MERCHANTABILITY AND FITNESS FOR A PARTICULAR PURPOSE ARE DISCLAIMED.

IN NO EVENT SHALL THE AUTHOR(S) BE LIABLE FOR ANY DIRECT, INDIRECT, INCIDENTAL, SPECIAL, EXEMPLARY, OR CONSEQUENTIAL DAMAGES (INCLUDING, BUT NOT LIMITED TO, PROCUREMENT OF SUBSTITUTE GOODS OR SERVICES; LOSS OF USE, DATA, OR PROFITS; OR BUSINESS INTERRUPTION) HOWEVER CAUSED AND ON ANY THEORY OF LIABILITY, WHETHER IN CONTRACT, STRICT LIABILITY, OR TORT (INCLUDING NEGLIGENCE OR OTHERWISE) ARISING IN ANY WAY OUT OF THE USE OF THIS SOFTWARE, EVEN IF ADVISED OF THE POSSIBILITY OF SUCH DAMAGE.

libupnp

Copyright © 2000-2003 Intel Corporation
All rights reserved.

Redistribution and use in source and binary forms, with or without modification, are permitted provided that the following conditions are met:

- * Redistributions of source code must retain the above copyright notice, this list of conditions and the following disclaimer.
- * Redistributions in binary form must reproduce the above copyright notice, this list of conditions and the following disclaimer in the documentation and/or other materials provided with the distribution.
- * Neither name of Intel Corporation nor the names of its contributors may be used to endorse or promote products derived from this software without specific prior written permission.

THIS SOFTWARE IS PROVIDED BY THE COPYRIGHT HOLDERS AND CONTRIBUTORS "AS IS" AND ANY EXPRESS OR IMPLIED WARRANTIES, INCLUDING, BUT NOT LIMITED TO, THE IMPLIED WARRANTIES OF MERCHANTABILITY AND FITNESS FOR A PARTICULAR PURPOSE ARE DISCLAIMED. IN NO EVENT SHALL INTEL OR CONTRIBUTORS BE LIABLE FOR ANY DIRECT, INDIRECT, INCIDENTAL, SPECIAL, EXEMPLARY, OR CONSEQUENTIAL DAMAGES (INCLUDING, BUT NOT LIMITED TO, PROCUREMENT OF SUBSTITUTE GOODS OR SERVICES; LOSS OF USE, DATA, OR PROFITS; OR BUSINESS INTERRUPTION) HOWEVER CAUSED AND ON ANY THEORY OF LIABILITY, WHETHER IN CONTRACT, STRICT LIABILITY, OR TORT (INCLUDING NEGLIGENCE OR OTHERWISE) ARISING IN ANY WAY OUT OF THE USE OF THIS SOFTWARE, EVEN IF ADVISED OF THE POSSIBILITY OF SUCH DAMAGE.

ntp

Copyright Notice

jpg "Clone me," says Dolly sheepishly

Last update: 02:45 UTC Tuesday, June 27, 2006

The following copyright notice applies to all files collectively called the Network Time Protocol Version 4 Distribution. Unless specifically declared otherwise in an individual file, this notice applies as if the text was explicitly included in the file.

Copyright © David L. Mills 1992-2006

Permission to use, copy, modify, and distribute this software and its documentation for any purpose with or without fee is hereby granted, provided that the above copyright notice appears in all copies and that both the copyright notice and this permission notice appear in supporting documentation, and that the name University of Delaware not be used in advertising or publicity pertaining to distribution of the software without specific, written prior permission. The University of Delaware makes no representations about the suitability this software for any purpose. It is provided "as is" without express or implied warranty.

openldap

The OpenLDAP Public License

Version 2.8, 17 August 2003

Redistribution and use of this software and associated documentation ("Software"), with or without modification, are permitted provided that the following conditions are met:

1. Redistributions in source form must retain copyright statements and notices,
2. Redistributions in binary form must reproduce applicable copyright statements and notices, this list of conditions, and the following disclaimer in the documentation and/or other materials provided with the distribution, and
3. Redistributions must contain a verbatim copy of this document.

The OpenLDAP Foundation may revise this license from time to time. Each revision is distinguished by a version number. You may use this Software under terms of this license revision or under the terms of any subsequent revision of the license.

THIS SOFTWARE IS PROVIDED BY THE OPENLDAP FOUNDATION AND ITS CONTRIBUTORS "AS IS" AND ANY EXPRESSED OR IMPLIED WARRANTIES, INCLUDING, BUT NOT LIMITED TO, THE IMPLIED WARRANTIES OF MERCHANTABILITY AND FITNESS FOR A PARTICULAR PURPOSE ARE DISCLAIMED. IN NO EVENT SHALL THE OPENLDAP FOUNDATION, ITS CONTRIBUTORS, OR THE AUTHOR(S) OR OWNER(S) OF THE SOFTWARE BE LIABLE FOR ANY DIRECT, INDIRECT, INCIDENTAL, SPECIAL, EXEMPLARY, OR CONSEQUENTIAL DAMAGES (INCLUDING, BUT NOT LIMITED TO, PROCUREMENT OF SUBSTITUTE GOODS OR SERVICES; LOSS OF USE, DATA, OR PROFITS; OR BUSINESS INTERRUPTION) HOWEVER CAUSED AND ON ANY THEORY OF LIABILITY, WHETHER IN CONTRACT, STRICT LIABILITY, OR TORT (INCLUDING NEGLIGENCE OR OTHERWISE) ARISING IN ANY WAY OUT OF THE USE OF THIS SOFTWARE, EVEN IF ADVISED OF THE POSSIBILITY OF SUCH DAMAGE.

The names of the authors and copyright holders must not be used in advertising or otherwise to promote the sale, use or other dealing in this Software without specific, written prior permission. Title to copyright in this Software shall at all times remain with copyright holders.

OpenLDAP is a registered trademark of the OpenLDAP Foundation.

Copyright 1999-2003 The OpenLDAP Foundation, Redwood City, California, USA. All Rights Reserved. Permission to copy and distribute verbatim copies of this document is granted.

openssl

LICENSE ISSUES

The OpenSSL toolkit stays under a dual license, i.e. both the conditions of the OpenSSL License and the original SSLeay license apply to the toolkit.

See below for the actual license texts. Actually both licenses are BSD-style Open Source licenses. In case of any license issues related to OpenSSL please contact openssl-core@openssl.org.

OpenSSL License

Copyright © 1998-2006 The OpenSSL Project. All rights reserved.

Redistribution and use in source and binary forms, with or without modification, are permitted provided that the following conditions are met:

1. Redistributions of source code must retain the above copyright notice, this list of conditions and the following disclaimer.
2. Redistributions in binary form must reproduce the above copyright notice, this list of conditions and the following disclaimer in the documentation and/or other materials provided with the distribution.
3. All advertising materials mentioning features or use of this software must display the following acknowledgment:
“This product includes software developed by the OpenSSL Project for use in the OpenSSL Toolkit. (<http://www.openssl.org/>)”
4. The names “OpenSSL Toolkit” and “OpenSSL Project” must not be used to endorse or promote products derived from this software without prior written permission. For written permission, please contact openssl-core@openssl.org.
5. Products derived from this software may not be called “OpenSSL” nor may “OpenSSL” appear in their names without prior written permission of the OpenSSL Project.
6. Redistributions of any form whatsoever must retain the following acknowledgment:
“This product includes software developed by the OpenSSL Project for use in the OpenSSL Toolkit. (<http://www.openssl.org/>)”

THIS SOFTWARE IS PROVIDED BY THE OpenSSL PROJECT “AS IS” AND ANY EXPRESSED OR IMPLIED WARRANTIES, INCLUDING, BUT NOT LIMITED TO, THE IMPLIED WARRANTIES OF MERCHANTABILITY AND FITNESS FOR A PARTICULAR PURPOSE ARE DISCLAIMED. IN NO EVENT SHALL THE OpenSSL PROJECT OR ITS CONTRIBUTORS BE LIABLE FOR ANY DIRECT, INDIRECT, INCIDENTAL, SPECIAL, EXEMPLARY, OR CONSEQUENTIAL DAMAGES (INCLUDING, BUT NOT LIMITED TO, PROCUREMENT OF SUBSTITUTE GOODS OR SERVICES; LOSS OF USE, DATA, OR PROFITS; OR BUSINESS INTERRUPTION) HOWEVER CAUSED AND ON ANY THEORY OF LIABILITY, WHETHER IN CONTRACT, STRICT LIABILITY, OR TORT (INCLUDING NEGLIGENCE OR OTHERWISE) ARISING IN ANY WAY OUT OF THE USE OF THIS SOFTWARE, EVEN IF ADVISED OF THE POSSIBILITY OF SUCH DAMAGE.

This product includes cryptographic software written by Eric Young (ey@cryptsoft.com).

This product includes software written by Tim Hudson (tjh@cryptsoft.com).

Software License Notice

Original SSLeay License

Copyright © 1995-1998 Eric Young (eay@cryptsoft.com) All rights reserved.

This package is an SSL implementation written by Eric Young (eay@cryptsoft.com).

The implementation was written so as to conform with Netscapes SSL.

This library is free for commercial and non-commercial use as long as the following conditions are adhered to. The following conditions apply to all code found in this distribution, be it the RC4, RSA, lhash, DES, etc., code; not just the SSL code. The SSL documentation included with this distribution is covered by the same copyright terms except that the holder is Tim Hudson (tjh@cryptsoft.com).

Copyright remains Eric Young's, and as such any Copyright notices in the code are not to be removed.

If this package is used in a product, Eric Young should be given attribution as the author of the parts of the library used.

This can be in the form of a textual message at program startup or in documentation (online or textual) provided with the package.

Redistribution and use in source and binary forms, with or without modification, are permitted provided that the following conditions are met:

7. Redistributions of source code must retain the copyright notice, this list of conditions and the following disclaimer.
8. Redistributions in binary form must reproduce the above copyright notice, this list of conditions and the following disclaimer in the documentation and/or other materials provided with the distribution.
9. All advertising materials mentioning features or use of this software must display the following acknowledgement:
"This product includes cryptographic software written by Eric Young (eay@cryptsoft.com)"
The word 'cryptographic' can be left out if the routines from the library being used are not cryptographic related :-).
10. If you include any Windows specific code (or a derivative thereof) from the apps directory (application code) you must include an acknowledgement:
"This product includes software written by Tim Hudson (tjh@cryptsoft.com)"

THIS SOFTWARE IS PROVIDED BY ERIC YOUNG "AS IS" AND ANY EXPRESS OR IMPLIED WARRANTIES, INCLUDING, BUT NOT LIMITED TO, THE IMPLIED WARRANTIES OF MERCHANTABILITY AND FITNESS FOR A PARTICULAR PURPOSE ARE DISCLAIMED. IN NO EVENT SHALL THE AUTHOR OR CONTRIBUTORS BE LIABLE FOR ANY DIRECT, INDIRECT, INCIDENTAL, SPECIAL, EXEMPLARY, OR CONSEQUENTIAL DAMAGES (INCLUDING, BUT NOT LIMITED TO, PROCUREMENT OF SUBSTITUTE GOODS OR SERVICES; LOSS OF USE, DATA, OR PROFITS; OR BUSINESS INTERRUPTION) HOWEVER CAUSED AND ON ANY THEORY OF LIABILITY, WHETHER IN CONTRACT, STRICT LIABILITY, OR TORT (INCLUDING NEGLIGENCE OR OTHERWISE) ARISING IN ANY WAY OUT OF THE USE OF THIS SOFTWARE, EVEN IF ADVISED OF THE POSSIBILITY OF SUCH DAMAGE.

The license and distribution terms for any publically available version or derivative of this code cannot be changed.

i.e. this code cannot simply be copied and put under another distribution license [including the GNU Public License.]

pam

Unless otherwise *explicitly* stated the following text describes the licensed conditions under which the contents of this Linux-PAM release may be distributed:

Redistribution and use in source and binary forms of Linux-PAM, with or without modification, are permitted provided that the following conditions are met:

1. Redistributions of source code must retain any existing copyright notice, and this entire permission notice in its entirety, including the disclaimer of warranties.
2. Redistributions in binary form must reproduce all prior and current copyright notices, this list of conditions, and the following disclaimer in the documentation and/or other materials provided with the distribution.
3. The name of any author may not be used to endorse or promote products derived from this software without their specific prior written permission.

ALTERNATIVELY, this product may be distributed under the terms of the GNU General Public License, in which case the provisions of the GNU GPL are required INSTEAD OF the above restrictions. (This clause is necessary due to a potential conflict between the GNU GPL and the restrictions contained in a BSD-style copyright.)

THIS SOFTWARE IS PROVIDED "AS IS" AND ANY EXPRESS OR IMPLIED WARRANTIES, INCLUDING, BUT NOT LIMITED TO, THE IMPLIED WARRANTIES OF MERCHANTABILITY AND FITNESS FOR A PARTICULAR PURPOSE ARE DISCLAIMED.

IN NO EVENT SHALL THE AUTHOR(S) BE LIABLE FOR ANY DIRECT, INDIRECT, INCIDENTAL, SPECIAL, EXEMPLARY, OR CONSEQUENTIAL DAMAGES (INCLUDING, BUT NOT LIMITED TO, PROCUREMENT OF SUBSTITUTE GOODS OR SERVICES; LOSS OF USE, DATA, OR PROFITS; OR BUSINESS INTERRUPTION) HOWEVER CAUSED AND ON ANY THEORY OF LIABILITY, WHETHER IN CONTRACT, STRICT LIABILITY, OR TORT (INCLUDING NEGLIGENCE OR OTHERWISE) ARISING IN ANY WAY OUT OF THE USE OF THIS SOFTWARE, EVEN IF ADVISED OF THE POSSIBILITY OF SUCH DAMAGE.

unzip

This is version 2005-Feb-10 of the Info-ZIP copyright and license.

The definitive version of this document should be available at <ftp://ftp.info-zip.org/pub/infozip/license.html> indefinitely.

Copyright © 1990-2005 Info-ZIP. All rights reserved.

For the purposes of this copyright and license, "Info-ZIP" is defined as the following set of individuals:

Mark Adler, John Bush, Karl Davis, Harald Denker, Jean-Michel Dubois, Jean-loup Gailly, Hunter Goatley, Ed Gordon, Ian Gorman, Chris Herboth, Dirk Haase, Greg Hartwig, Robert Heath, Jonathan Hudson, Paul Kienitz, David Kirschbaum, Johnny Lee, Onno van der Linden, Igor Mandrichenko, Steve P. Miller, Sergio Monesi, Keith Owens, George Petrov, Greg Roelofs, Kai Uwe Rommel, Steve Salisbury, Dave Smith, Steven M. Schweda, Christian Spieler, Cosmin Truta, Antoine Verheijen, Paul von Behren, Rich Wales, Mike White

This software is provided "as is," without warranty of any kind, express or implied. In no event shall Info-ZIP or its contributors be held liable for any direct, indirect, incidental, special or consequential damages arising out of the use of or inability to use this software.

Permission is granted to anyone to use this software for any purpose, including commercial applications, and to alter it and redistribute it freely, subject to the following restrictions:

Software License Notice

1. Redistributions of source code must retain the above copyright notice, definition, disclaimer, and this list of conditions.
2. Redistributions in binary form (compiled executables) must reproduce the above copyright notice, definition, disclaimer, and this list of conditions in documentation and/or other materials provided with the distribution. The sole exception to this condition is redistribution of a standard UnZipSFX binary (including SFXWiz) as part of a self-extracting archive; that is permitted without inclusion of this license, as long as the normal SFX banner has not been removed from the binary or disabled.
3. Altered versions — including, but not limited to, ports to new operating systems, existing ports with new graphical interfaces, and dynamic, shared, or static library versions — must be plainly marked as such and must not be misrepresented as being the original source. Such altered versions also must not be misrepresented as being Info-ZIP releases — including, but not limited to, labeling of the altered versions with the names “Info-ZIP” (or any variation thereof, including, but not limited to, different capitalizations), “Pocket UnZip,” “WiZ” or “MacZip” without the explicit permission of Info-ZIP. Such altered versions are further prohibited from misrepresentative use of the Zip-Bugs or Info-ZIP e-mail addresses or of the Info-ZIP URL(s).
4. Info-ZIP retains the right to use the names “Info-ZIP,” “Zip,” “UnZip,” “UnZipSFX,” “WiZ,” “Pocket UnZip,” “Pocket Zip,” and “MacZip” for its own source and binary releases.

zlib

© 1995-2004 Jean-loup Gailly and Mark Adler

This software is provided ‘as-is’, without any express or implied warranty. In no event will the authors be held liable for any damages arising from the use of this software.

Permission is granted to anyone to use this software for any purpose, including commercial applications, and to alter it and redistribute it freely, subject to the following restrictions:

1. The origin of this software must not be misrepresented; you must not claim that you wrote the original software. If you use this software in a product, an acknowledgment in the product documentation would be appreciated but is not required.
2. Altered source versions must be plainly marked as such, and must not be misrepresented as being the original software.
3. This notice may not be removed or altered from any source distribution.

Jean-loup Gailly
jloup@gzip.org

Mark Adler
madler@alumni.caltech.edu

If you use the zlib library in a product, we would appreciate *not* receiving lengthy legal documents to sign. The sources are provided for free but without warranty of any kind. The library has been entirely written by Jean-loup Gailly and Mark Adler; it does not include third-party code.

If you redistribute modified sources, we would appreciate that you include in the file ChangeLog history information documenting your changes. Please read the FAQ for more information on the distribution of modified source versions.

MIDI Data Format

If you are familiar with MIDI, or are using a computer to control your music software with computer-generated MIDI messages, the data provided in this section can help you to control your Disklavier. Messages include those that can be received by the piano part and/or those that can be received by an ESBL part. Messages that can be transmitted as well as received are shown as “transmitted.”

1. CHANNEL MESSAGES

1.1 Key On / Key Off

(Piano Part, ESBL Part) (transmitted)

Piano Part reception note range = A-1-C7 : C3=60

ESBL part reception note range = C-2-G8

Velocity range = 1-127 (Only the Key On velocity is received)

1.2 Control Change

1.2.1 Bank Select

(ESBL Part) (transmitted)

Cntrl#	Parameter	Data Range
0	Bank Select MSB	0: Normal, 63: User voice, 64: SFX, 126: SFX kit, 127: Drum
32	Bank Select LSB	0...127

You can select the Voice banks with MSB and LSB numbers. MSB and LSB functions differently depending on the play mode. In XG mode, MSB numbers select Voice type (Normal Voice or Drum Voice), and LSB number select Voice banks. In TG300B mode, LSB is fixed, and MSB numbers select Voice banks.

(See Normal Voice List Drum Voice List.)

A new bank selection will not become effective until the next Program Change message is received.

1.2.2 Modulation

(ESBL Part)

Cntrl#	Parameter	Data Range
1	Modulation	0...127

1.2.3 Portamento Time

(ESBL Part)

Cntrl#	Parameter	Data Range
5	Portamento Time	0...127

When the parameter 1.2.9 Portamento = ON, values will adjust the speed of pitch change.

A setting of 0 - minimum portamento time, and 127 - maximum portamento time.

1.2.4 Data Entry

(ESBL Part)

Messages which set the value for the parameter specified by RPN/NRPN.

Cntrl#	Parameter	Data Range
6	Data Entry MSB	0...127
38	Data Entry LSB	0...127

Parameter value is determined by combining MSB and LSB.

1.2.5 Main Volume

(Piano Part, ESBL Part) (transmitted)

Cntrl#	Parameter	Data Range
7	Main Volume	0...127

1.2.6 Pan

(ESBL Part)

Cntrl#	Parameter	Data Range
10	Pan	0...127

1.2.7 Expression

(Piano Part, ESBL Part)

Cntrl#	Parameter	Data Range
11	Expression	0...127

1.2.8 Hold1

(Piano Part, ESBL Part) (transmitted)

Cntrl#	Parameter	Data Range
64	Hold1	0...127 (0-63:off, 64-127:on)

1.2.9 Portamento (ESBL Part)

Cntrl#	Parameter	Data Range
65	Portamento	0...127 (0-63:off, 64-127:on)

1.2.10 Sostenuto

(Piano Part, ESBL Part) (transmitted)

Cntrl#	Parameter	Data Range
66	Sostenuto	0...127 (0-63:off, 64-127:on)

1.2.11 Soft Pedal

(Piano Part, ESBL Part) (transmitted)

Cntrl#	Parameter	Data Range
67	Soft Pedal	0...127 (0-63:off, 64-127:on)

1.2.12 Harmonic Content

(ESBL Part)

Messages which adjust the resonance set for each Voice.

Cntrl#	Parameter	Data Range
71	Harmonic Content	0...127 (0:-64, 64:+0, 127:+63)

Higher values will result in a more characteristic, resonant sound.

Depending on the Voice, the effective range may be narrower than the range available for adjustment.

1.2.13 Release Time

(ESBL Part)

Messages which adjust the envelope release time set for each Voice.

Cntrl#	Parameter	Data Range
72	Release Time	0...127 (0:-64, 64:+0, 127:+63)

1.2.14 Attack Time

(ESBL Part)

Messages which adjust the envelope attack time set for each Voice.

Cntrl#	Parameter	Data Range
73	Attack Time	0...127 (0:-64, 64:+0, 127:+63)

1.2.15 Brightness

(ESBL Part)

Messages which adjust the filter cutoff frequency set for each Voice.

Cntrl#	Parameter	Data Range
74	Brightness	0...127 (0:-64, 64:+0, 127:+63)

1.2.16 Portamento Control

(ESBL Part)

Messages which apply a portamento between the currently-sounding note and the subsequent note.

Cntrl#	Parameter	Data Range
84	Portamento Control	0...127

1.2.17 Effect1 Depth (Reverb Send Level)

(ESBL Part)

Cntrl#	Parameter	Data Range
91	Effect1 Depth	0...127

MIDI Data Format

1.2.18 Effect3 Depth (Chorus Send Level) (ESBL Part)

Cntrl#	Parameter	Data Range
93	Effect3 Depth	0...127

1.2.19 Effect4 Depth (Variation Effect Send Level) (ESBL Part)

Cntrl#	Parameter	Data Range
94	Effect4 Depth	0...127

1.2.20 Data Increment / Decrement (for RPN) (ESBL Part)

Cntrl#	Parameter	Data Range
96	RPN Increment	0...127
97	RPN Decrement	0...127

1.2.21 NRPN (Non-Registered Parameter Number) (ESBL Part)

Cntrl#	Parameter	Data Range
98	NRPN LSB	0...127
99	NRPN MSB	0...127

First send the NRPN MSB and NRPN LSB to specify the parameter which is to be controlled. Then use Data Entry to set the value of the specified parameter.

* Note that once the NRPN has been set for a channel subsequent data entry will be recognized as the same NRPN's value change. Therefore, after you use the NRPN, you should set a Null (7FH, 7FH) value to avoid an unexpected result.

The following NRPN number can be received.

NRPN	Data entry	PARAMETER NAME and VALUE RANGE
MSB	LSB	MSB
\$01	\$08	\$mm Vibrato Rate mm : \$00 - \$40 - \$7F (-64 - 0 - +63)
\$01	\$09	\$mm Vibrato Depth mm : \$00 - \$40 - \$7F (-64 - 0 - +63)
\$01	\$0A	\$mm Vibrato Delay mm : \$00 - \$40 - \$7F (-64 - 0 - +63)
\$01	\$20	\$mm Filter Cutoff Frequency mm : \$00 - \$40 - \$7F (-64 - 0 - +63)
\$01	\$21	\$mm Filter Resonance mm : \$00 - \$40 - \$7F (-64 - 0 - +63)
\$01	\$63	\$mm EG Attack Time mm : \$00 - \$40 - \$7F (-64 - 0 - +63)
\$01	\$64	\$mm EG Decay Time mm : \$00 - \$40 - \$7F (-64 - 0 - +63)
\$01	\$66	\$mm EG Release Time mm : \$00 - \$40 - \$7F (-64 - 0 - +63)
\$14	\$rr	\$mm Drum Filter Cutoff Frequency mm : \$00 - \$40 - \$7F (-64 - 0 - +63) rr : drum instrument note number
\$15	\$rr	\$mm Drum Filter Resonance mm : \$00 - \$40 - \$7F (-64 - 0 - +63) rr : drum instrument note number
\$16	\$rr	\$mm Drum EG Attack mm : \$00 - \$40 - \$7F (-64 - 0 - +63) rr : drum instrument note number
\$17	\$rr	\$mm Drum EG Decay Rate mm : \$00 - \$40 - \$7F (-64 - 0 - +63) rr : drum instrument note number Applies to both Decay1 and 2.
\$18	\$rr	\$mm Drum Instrument Pitch Coarse mm : \$00 - \$40 - \$7F (-64 - 0 - +63) rr : drum instrument note number
\$19	\$rr	\$mm Drum Instrument Pitch Fine mm : \$00 - \$40 - \$7F (-64 - 0 - +63) rr : drum instrument note number
\$1A	\$rr	\$mm Drum Instrument Level mm : \$00 - \$7F (0 - max) rr : drum instrument note number
\$1C	\$rr	\$mm Drum Instrument Pan mm : \$00 - \$40 - \$7F (random, left - center - right) rr : drum instrument note number

\$1D \$rr \$mm Drum Instrument Reverb Send Level
mm : \$00 - \$7F (0 - max)
rr : drum instrument note number

\$1E \$rr \$mm Drum Instrument Chorus Send Level
mm : \$00 - \$7F (0 - max)
rr : drum instrument note number

\$1F \$rr \$mm Drum Instrument Variation Send Level
mm : \$00 - \$7F (0 - max)
rr : drum instrument note number

MSB 14H- 1FH (for Drum) is valid only if the Multi Part parameter PART MODE = DRUMS 1 or DRUMS2 for that channel. (If PART MODE = DRUM, no values will be changed.)

1.2.22 RPN (Registered Parameter Number) (ESBL Part)

Cntrl#	Parameter	Data Range
100	RPN LSB	0...127
101	RPN MSB	0...127

The following RPN numbers can be received.

RPN	Data entry	PARAMETER NAME and VALUE RANGE
MSB	LSB	MSB
00H	00H	mmH — Pitch Bend Sensitivity mm:00-18H (0-24 chromatic steps) Assignable in chromatic steps up to 2 octaves Default : 02H LSB value is ignored.
00H	01H	mmH 11H Fine Tuning mm: 00H-40H-7FH (-64-0-+63)
00H	02H	mmH — Coarse Tuning mm: 28H - 40H - 58H (-24 - +24 chromatic steps) LSB value is ignored.
7FH	7FH	— — RPN null Cancels RPN and NRPN numbers

1.2.23 Channel Mode Messages

The following Channel Mode Messages can be received.

2nd byte	3rd byte	
120	0	All Sound Off
121	0	Reset All Controllers
123	0	All Note Off
124	0	Omni Off
125	0	Omni On
126	0 ~ 16	Mono
127	0	Poly

1.2.23.1 All Sound Off

(Piano Part, ESBL Part) (transmitted)

ESBL part;

Terminates all sounds currently sounding on the specified channel. However, the status of channel messages such as Note On and Hold On is maintained.

Piano Part;

The status of channel messages is not maintained.

1.2.23.2 Reset All Controllers

(ESBL Part)

The values of the following controllers will be reset to the defaults.

CONTROLLER	VALUE
Pitch Bend Change	±0 (center)
Channel Aftertouch	0 (off)
Polyphonic Aftertouch	0 (off)
Modulation	0 (off)
Expression	127 (max)
Hold 1	0 (off)
Portamento	0 (off)
Sostenuto	0 (off)
Soft Pedal	0 (off)

Portamento Control cancels the Portamento Source Key Number that was received
 RPN number not specified; internal data will not change
 NRPN number not specified; internal data will not change

1.2.23.3 All Note Off

(Piano Part, ESBL Part) (transmitted)

Terminates all notes currently on for the specified channel. However, if Hold 1 or Sostenuto is on, notes will continue sounding until these are turned off.

1.2.23.4 Omni Off

(Piano Part, ESBL Part)

Performs the same function as when an All Notes Off message is received.

1.2.23.5 Omni On

(Piano Part, ESBL Part)

Performs the same function as when an All Notes Off message is received.

1.2.23.6 Mono

(Piano Part, ESBL Part)

Performs the same function as when an All Sounds on message is received, and if the 3rd byte (mono number) is in the range of 0 - 16, sets the corresponding channel to Mono Mode (Mode 4 : m = 1).

1.2.23.7 Poly

(Piano Part, ESBL Part)

Performs the same function as when an All Sounds Off message is received. and sets the corresponding channel to Poly Mode (Mode 3).

1.2.24 Local Control

(Piano Part, ESBL Part)

0;Off Disklavier keyboard does not play the internal voices.
 127;On

1.3 Program Change

(ESBL Part) (transmitted)

Messages for Voice selection. With a combination of Bank Select, you can select not only basic Voice numbers, but also variation Voice bank numbers.

1.4 Pitch Bend

(ESBL Part)

When Multi Part Parameter Rcv PITCH BEND CHANGE=OFF, pitch bend for that part is not received.

1.5 Channel Aftertouch

(ESBL Part)

1.6 Polyphonic Aftertouch

(ESBL Part) (PianoPart) (transmitted)

Applying further pressure on the key does not output "key aftertouch" information. Instead, key position is transmitted as additional information.

2. SYSTEM EXCLUSIVE MESSAGES

2.1 Parameter Change

The Disklavier receives the following parameter change messages.

[UNIVERSAL REALTIME MESSAGE]

1) Master Volume

[UNIVERSAL NON REALTIME MESSAGE]

1) General MIDI Mode On

[XG NATIVE]

1) XG System on

2) XG System Data parameter change

3) Multi Effect1 Data parameter change

4) Multi Part Data parameter change

5) Drums Setup Data parameter change

[OTHER]

1) Master tuning

2) TG300 System Data Parameter change

3) TG300 Multi Effect Data parameter change

4) TG300 Multi Part Data parameter change

2.1.2 Universal Realtime Messages

2.1.2.1 Master Volume

(Piano Part, ESBL Part)

11110000	F0	= Exclusive status
01111111	7F	= Universal Real Time
01111111	7F	= ID of target device
0000100	04	= Sub-ID #1=Device Control Message
00000001	01	= Sub-ID #2=Master Volume
0sssssss	*SS	= Volume LSB
0ttttttt	TT	= Volume MSB
11110111	F7	= End of Exclusive

or

11110000	F0	= Exclusive status
01111111	7F	= Universal Real Time
0xxxxnnn	XN	= Device Number, xxx = don't care
0000100	04	= Sub-ID #1=Device Control Message
00000001	01	= Sub-ID #2=Master Volume
0sssssss	SS	= Volume LSB
0ttttttt	TT	= Volume MSB
11110111	F7	= End of Exclusive

When received, the Volume MSB will be effective for the System Parameter MASTER VOLUME.

* "SS" is the hexadecimal expression of Osssssss; same as for "tt", "aa", etc.

2.1.3 Universal Non-Realtime Messages

2.1.3.1 General MIDI Mode On

(ESBL Part)

11110000	F0	= Exclusive status
01111110	7E	= Universal Non-Real Time
01111111	7F	= ID of target device
00001001	09	= Sub-ID #1=General MIDI Message
00000001	01	= Sub-ID #2=General MIDI On
11110111	F7	= End of Exclusive

or

11110000	F0	= Exclusive status
01111110	7E	= Universal Non-Real Time
0xxxxnnn	XN	= Device Number, xxx = don't care
00001001	09	= Sub-ID #1=General MIDI Message
00000001	01	= Sub-ID #2=General MIDI On
11110111	F7	= End of Exclusive

When General MIDI Mode On is received. the play mode will be changed to XG mode.

When this happens, the ESBL part will receive the MIDI messages which compatible with GM System Level 1, and consequently will not receive NRPN and Bank Select messages. Since approximately 50ms is required to execute this message, be sure to leave an appropriate interval before the subsequent message.

2.1.4 XG Native Parameter Change

(ESBL Part)

With the Parameter Change messages as listed below, you can change the characteristic of a Voice, such as by Effect Type or effect parameter, transpose, tuning, and others.

11110000	F0	Exclusive status
01000011	43	YAMAHA ID
0001nnnn	1n	Device Number
01001100	4C	XG Model ID
0aaaaaaa	aaaaaa	Address High
0aaaaaaa	aaaaaa	Address Mid
0aaaaaaa	aaaaaa	Address Low
0ddddd	ddddd	Data
11110111	F7	End of Exclusive

* Any number is OK since the device number for the Disklavier is fixed to "All."

MIDI Data Format

For parameters with data size of 2 or 4, transmit the appropriate number of data bytes.

When sending the parameter change messages consecutively, be sure to leave an appropriate interval (if the time base is 480. ca 5 unit) between the messages.

2.1.4.1 XG System On (ESBL Part)

11110000	F0	Exclusive status
01000011	43	YAMAHA ID
0001nnnn	1N	Device Number
01001100	4C	XG Model ID
0aaaaaaa	00	Address High
0aaaaaaa	00	Address Mid
0aaaaaaa	7E	Address Low
00000000	00	Data
11110111	F7	End of Exclusive

When this data is received, the Disklavier will switch to XG mode and all the parameters will be initialized accordingly, and XG-compatible messages such as NRPN and Bank Select messages can be received.

Since approximately 50ms is required to execute this message, be sure to leave an appropriate interval before the subsequent message

2.1.4.2 XG System Data parameter change (ESBL Part)

See tables <1-1> and <1-2>.

2.1.4.3 Multi Effect1 Data parameter change (ESBL Part)

See tables <1-1> and <1-3>.

2.1.4.4 Multi Part Data parameter change (ESBL Part)

See tables <1-1> and <1-4>.

2.1.4.5 Drums Setup Data parameter change (ESBL Part)

See tables <1-1> and <1-5>.

If a Drum Setup Reset parameter change message is received, the Drum Setup parameter values will be initialized.

Selecting a Drum Set will cause the Drum Setup parameter values to be initialized.

2.1.5 Other parameter changes

2.1.5.1 Master Tuning (ESBL Part)

11110000	F0	Exclusive status
01000011	43	YAMAHA ID
0001nnnn	1n	Device Number
00100111	27	Model ID
00110000	30	Sub ID2
00000000	00	
00000000	00	
0mmmmmmm	mm	Master Tune MSB
0lllllll	ll	Master Tune LSB
0ccccccc	cc	
11110111	F7	End of Exclusive

This message simultaneously changes the pitch of all channels.

2.2 Bulk Dump (ESBL Part)

The Disklavier receives the following bulk dump data.

[XG NATIVE]

- 1) XG System Data
- 2) Multi Effect1 Data
- 3) Multi Part Data
- 4) Drums Setup Data

[QS300 NATIVE]

- 1) QS300 User Normal Voice Data

2.2.1 XG Native Bulk Dump

11110000	F0	Exclusive status
01000011	43	YAMAHA ID
0000nnnn	0n	Device Number
01001100	4C	XG Model ID
0bbbbbbb	bbbbbbb	ByteCount
0bbbbbbb	bbbbbbb	ByteCount
0aaaaaaa	aaaaaaa	Address High
0aaaaaaa	aaaaaaa	Address Mid
0aaaaaaa	aaaaaaa	Address Low
0ddddddd	dd	Data
0ccccccc	ccccccc	Checksum
11110111	F7	End of Exclusive

For the Address and Byte Count, refer to the supplementary tables.

The Checksum is the value that results in a value of 0 for the lower 7 bits when the Start Address, Byte Count, plus the Checksum itself are added.

2.2.1.1 XG System Data bulk dump (ESBL Part)

See tables <1-1> and <1-2>.

2.2.1.2 Multi Effect1 Data bulk dump (ESBL Part)

See tables <1-1> and <1-3>.

2.2.1.3 Multi Part Data bulk dump (ESBL Part)

See tables <1-1> and <1-4>.

2.2.1.4 Drums Setup Data bulk dump (ESBL Part)

See tables <1-1> and <1-5>.

2.2.2 QS300 Native Bulk Dump

11110000	F0	Exclusive status
01000011	43	YAMAHA ID
0000nnnn	0n	Device Number
01001101	4B	QS300 Model ID
0bbbbbbb	bbbbbbb	ByteCount
0bbbbbbb	bbbbbbb	ByteCount
0aaaaaaa	aaaaaaa	Address High
0aaaaaaa	aaaaaaa	Address Mid
0aaaaaaa	aaaaaaa	Address Low
0ddddddd	dd	Data
0ccccccc	ccccccc	Checksum
11110111	F7	End of Exclusive

2.2.2.1 QS300 User Normal Voice Data bulk dump (ESBL Part)

See tables <2-1> and <2-2>.

3. SYSTEM REALTIME MESSAGES

3.1 Active Sensing

- a) Transmission Transmitted.
- b) Reception
Once FE has been received, if no MIDI data is subsequently received for longer than an interval of approximately 300msec. the Disklavier will perform the same function as when ALL SOUNDS OFF, ALL NOTES OFF, and RESET ALL CONTROLLERS messages are received, and will then return to a status in which FE is not monitored.

3.2 Start

- a) Transmission
This message is transmitted only when the REMOTE OUT parameter is set to On.
- b) Reception
This message is received only when REMOTE IN Parameter is Set to On.

3.3 Stop

- a) Transmission
This message is transmitted only when the REMOTE OUT parameter is set to On.
- b) Reception
This message is received only when REMOTE IN Parameter is Set to On.

<Table 1-1>

Parameter Bass Address
Model ID = 4C [XG]

	Parameter Change Address			Description
	(H)	(M)	(L)	
XG SYSTEM	00	00	00	System
	00	00	7D	Drum setup Reset
	00	00	7E	XG System On
	00	00	7F	All Parameter Reset
EFFECT1	02	01	00	Effect1 (Reverb, Chorus, Variation)
MULTI PART	08	00	00	Multi Part 1 :
	08	0F	00	Multi Part 16
DRUM	30	18	00	Drum Setup 1
	30	18	00	Drum Setup 2

----->

Address	Parameter
3n 0B 00	note number 13
3n 0C 00	note number 14
:	:
3n 5B 00	note number 91

n: Drum setup number (0, 1)

<Table 1-2>

MIDI Parameter Change table (SYSTEM) [XG]

Address (H)	Size (H)	Data (H)	Parameter	Description (H)	Default value (H)
00 00 00	4	0000-07FF	MASTER TUNE	-102.4 - +102.3 [cent] 1st bit3-0→bit15-12 2nd bit3-0→bit11-8 3rd bit3-0→bit7-4 4th bit3-0→bit3-0	00 04 00 00 -400
04	1	00 - 7F	MASTER VOLUME	0 - 127	7F
05	1	00 - 7F	not used		
06	1	28 - 58	TRANSPOSE	-24 - +24 [semitones]	40
7D	n		DRUM SETUP RESET	n=Drum setup number	
7E	00		XG SYSTEM ON	00=XG system ON (receive only)	
7F	00		ALL PARAMETER RESET	00=ON (receive only)	
TOTAL SIZE		07			

<Table 1-3>

MIDI Parameter Change table (EFFECT 1) [XG]

Address (H)	Size (H)	Data (H)	Parameter	Description	Default value (H)
02 01 00	2	00-7F	REVERB TYPE MSB	see Effect Type List	01(=HALL1)
		00-7F	REVERB TYPE LSB	00 : basic type	00
02	1	00-7F	REVERB PARAMETER 1	see Effect Parameter List	Depends on reverb type
03	1	00-7F	REVERB PARAMETER 2	"	"
04	1	00-7F	REVERB PARAMETER 3	"	"
05	1	00-7F	REVERB PARAMETER 4	"	"
06	1	00-7F	REVERB PARAMETER 5	"	"
07	1	00-7F	REVERB PARAMETER 6	"	"
08	1	00-7F	REVERB PARAMETER 7	"	"
09	1	00-7F	REVERB PARAMETER 8	"	"
0A	1	00-7F	REVERB PARAMETER 9	"	"
0B	1	00-7F	REVERB PARAMETER 10	"	"
0C	1	00-7F	REVERB RETURN	-∞dB...0dB...+6dB(0...64...127)	40
0D	1	01-7F	REVERB PAN	L63...C...R63(1...64...127)	40

MIDI Data Format

TOTAL SIZE		0E				
02	01	10	1	00-7F	REVERB PARAMETER 11	see Effect Parameter List
		11	1	00-7F	REVERB PARAMETER 12	Depends on reverb type
		12	1	00-7F	REVERB PARAMETER 13	"
		13	1	00-7F	REVERB PARAMETER 14	"
		14	1	00-7F	REVERB PARAMETER 15	"
		15	1	00-7F	REVERB PARAMETER 16	"
TOTAL SIZE		6				
02	01	20	2	00-7F	CHORUS TYPE MSB	see Effect Type List
				00-7F	CHORUS TYPE LSB	00 : basic type
		22	1	00-7F	CHORUS PARAMETER 1	41 (=CHORUS1)
		23	1	00-7F	CHORUS PARAMETER 2	00
		24	1	00-7F	CHORUS PARAMETER 3	Depends on chorus Type
		25	1	00-7F	CHORUS PARAMETER 4	"
		26	1	00-7F	CHORUS PARAMETER 5	"
		27	1	00-7F	CHORUS PARAMETER 6	"
		28	1	00-7F	CHORUS PARAMETER 7	"
		29	1	00-7F	CHORUS PARAMETER 8	"
		2A	1	00-7F	CHORUS PARAMETER 9	"
		2B	1	00-7F	CHORUS PARAMETER 10	"
		2C	1	00-7F	CHORUS RETURN	-∞dB...0dB...+6dB(0...64...127)
		2D	1	01-7F	CHORUS PAN	L63...C...R63(1...64...127)
		2E	1	00-7F	SEND CHORUS TO REVERB	-∞dB...0dB... +6dB(0...64...127)
TOTAL SIZE		0F				
02	01	30	1	00-7F	CHORUS PARAMETER 11	see Effect Parameter List
		31	1	00-7F	CHORUS PARAMETER 12	Depends on chorus Type
		32	1	00-7F	CHORUS PARAMETER 13	"
		33	1	00-7F	CHORUS PARAMETER 14	"
		34	1	00-7F	CHORUS PARAMETER 15	"
		35	1	00-7F	CHORUS PARAMETER 16	"
TOTAL SIZE		6				
02	01	40	2	00-7F	VARIATION TYPE MSB	see Effect Type List
				00-7F	VARIATION TYPE LSB	00 : basic type
		42	2	00-7F	VARIATION PARAMETER 1 MSB	see Effect Parameter List
				00-7F	VARIATION PARAMETER 1 LSB	Depends on variation type
		44	2	00-7F	VARIATION PARAMETER 2 MSB	"
				00-7F	VARIATION PARAMETER 2 LSB	"
		46	2	00-7F	VARIATION PARAMETER 3 MSB	"
				00-7F	VARIATION PARAMETER 3 LSB	"
		48	2	00-7F	VARIATION PARAMETER 4 MSB	"
				00-7F	VARIATION PARAMETER 4 LSB	"
		4A	2	00-7F	VARIATION PARAMETER 5 MSB	"
				00-7F	VARIATION PARAMETER 5 LSB	"
		4C	2	00-7F	VARIATION PARAMETER 6 MSB	"
				00-7F	VARIATION PARAMETER 6 LSB	"
		4E	2	00-7F	VARIATION PARAMETER 7 MSB	"
				00-7F	VARIATION PARAMETER 7 LSB	"
		50	2	00-7F	VARIATION PARAMETER 8 MSB	"
				00-7F	VARIATION PARAMETER 8 LSB	"
		52	2	00-7F	VARIATION PARAMETER 9 MSB	"
				00-7F	VARIATION PARAMETER 9 LSB	"
		54	2	00-7F	VARIATION PARAMETER 10 MSB	"
				00-7F	VARIATION PARAMETER 10 LSB	"
		56	1	00-7F	VARIATION RETURN	-∞ dB...0dB...+6dB(0...64...127)
		57	1	01-7F	VARIATION PAN	L63...C...R63(1...64...127)
		58	1	00-7F	SEND VARIATION TO REVERB	-∞ dB...0dB...+6dB(0...64...127)
		59	1	00-7F	SEND VARIATION TO CHORUS	-∞ dB...0dB...+6dB(0...64...127)
		5A	1	00-01	VARIATION CONNECTION	0:INSERTION, 1:SYSTEM
		5B	1	00-0F,7F	VARIATION PART	Part1...16(0...15)
						0FF (127)
		5C	1	00-7F	MW VARIATION CONTROL DEPTH	-64 - +63
		5D	1	00-7F	BEND VARIATION CONTROL DEPTH	-64 - +63
		5E	1	00-7F	CAT VARIATION CONTROL DEPTH	-64 - +63
		5F	1	00-7F	AC1 VARIATION CONTROL DEPTH	-64 - +63
		60	1	00-7F	AC2 VARIATION CONTROL DEPTH	-64 - +63
TOTAL SIZE		21				
02	01	70	1	00-7F	VARIATION PARAMETER 11	see Effect Parameter List
		71	1	00-7F	VARIATION PARAMETER 12	Depends on variation type
		72	1	00-7F	VARIATION PARAMETER 13	"
		73	1	00-7F	VARIATION PARAMETER 14	"
		74	1	00-7F	VARIATION PARAMETER 15	"
		75	1	00-7F	VARIATION PARAMETER 16	"
TOTAL SIZE		6				

<Table 1-4>

MIDI Parameter Change table (MULTI PART) [XG]

Address (H)		Size (H)	Data (H)	Parameter	Description	Default value (H)
08	nn	00	1	00 - 20	ELEMENT RESERVE	0 - 32
	nn	01	1	00 - 7F	BANK SELECT MSB	0 - 127
	nn	02	1	00 - 7F	BANK SELECT LSB	0 - 127
	nn	03	1	00 - 7F	PROGRAM NUMBER	1 - 128
	nn	04	1	00 - 0F, 7F	Rev CHANNEL	1 - 16, OFF
	nn	05	1	00 - 01	MONO/POLY MODE	0: MONO 1: POLY
	nn	06	1	00 - 02	SAME NOTE NUMBER KEY ON ASSIGN	0: SINGLE 1: MULTI 2: INST (for DRUM)
	nn	07	1	00 - 03	PART MODE	0: NORMAL 1: DRUM 2-3: DRUMS1 - 2
	nn	08	1	28 - 58	NOTE SHIFT	-24 - +24 [semitones]
	nn	09	2	00 - FF	DETUNE	-12.8 - +12.7 [Hz]
	nn	0A				1st bit3-0→bit7-4 2nd bit3-0→bit3-0
	nn	0B	1	00 - 7F	VOLUME	0 - 127
	nn	0C	1	00 - 7F	VELOCITY SENSE DEPTH	0 - 127
	nn	0D	1	00 - 7F	VELOCITY SENSE OFFSET	0 - 127
	nn	0E	1	00 - 7F	PAN	0/random, 1/L63-64/C-127/R63
	nn	0F	1	00 - 7F	NOTE LIMIT LOW	C-2 - G8
	nn	10	1	00 - 7F	NOTE LIMIT HIGH	C-2 - G8
	nn	11	1	00 - 7F	DRY LEVEL	0 - 127
	nn	12	1	00 - 7F	CHORUS SEND	0 - 127
	nn	13	1	00 - 7F	REVERB SEND	0 - 127
	nn	14	1	00 - 7F	VARIATION SEND	0 - 127
	nn	15	1	00 - 7F	VIBRATO RATE	-64 - +63
	nn	16	1	00 - 7F	VIBRATO DEPTH	-64 - +63
	nn	17	1	00 - 7F	VIBRATO DELAY	-64 - +63
	nn	18	1	00 - 7F	FILTER CUTOFF FREQUENCY	-64 - +63
	nn	19	1	00 - 7F	FILTER RESONANCE	-64 - +63
	nn	1A	1	00 - 7F	EG ATTACK TIME	-64 - +63
	nn	1B	1	00 - 7F	EG DECAY TIME	-64 - +63
	nn	1C	1	00 - 7F	EG RELEASE TIME	-61 - +63
	nn	1D	1	28 - 58	MW PITCH CONTROL	-24 - +24 [semitones]
	nn	1E	1	00 - 7F	MW FILTER CONTROL	-9600 - +9450 [cent]
	nn	1F	1	00 - 7F	MW AMPLITUDE CONTROL	-64 - +63
	nn	20	1	00 - 7F	MW LFO PMOD DEPTH	0 - 127
	nn	21	1	00 - 7F	MW LFO FMOD DEPTH	0 - 127
	nn	22	1	00 - 7F	MW LFO AMOD DEPTH	0 - 127
	nn	23	1	28 - 58	BEND PITCH CONTROL	-24 - +24 [semitones]
	nn	24	1	00 - 7F	BEND FILTER CONTROL	-9600 - +9450 [cent]
	nn	25	1	00 - 7F	BEND AMPLITUDE CONTROL	-64 - +63
	nn	26	1	00 - 7F	BEND LFO PMOD DEPTH	+100 - +100 [%]
	nn	27	1	00 - 7F	BEND LFO FMOD DEPTH	+100 - +100 [%]
	nn	28	1	00 - 7F	BEND LFO AMOD DEPTH	+100 - +100 [%]
	TOTAL SIZE		29			
	nn	30	1	00 - 01	Rev PITCH BEND	0/OFF, 1/ON
	nn	31	1	00 - 01	Rev CH AFTER TOUCH (CAT)	0/OFF, 1/ON
	nn	32	1	00 - 01	Rev PROGRAM CHANGE	0/OFF, 1/ON
	nn	33	1	00 - 01	Rev CONTROL CHANGE	0/OFF, 1/ON
	nn	34	1	00 - 01	Rev POLY AFTER TOUCH (PAT)	0/OFF, 1/ON
	nn	35	1	00 - 01	Rev NOTE MESSAGE	0/OFF, 1/ON
	nn	36	1	00 - 01	Rev RPN	0/OFF, 1/ON
	nn	37	1	00 - 01	Rev NRPN	0/OFF, 1/ON
	nn	38	1	00 - 01	Rev MODULATION	0/OFF, 1/ON
	nn	39	1	00 - 01	Rev VOLUME	0/OFF, 1/ON
	nn	3A	1	00 - 01	Rev PAN	0/OFF, 1/ON
	nn	3B	1	00 - 01	Rev EXPRESSION	0/OFF, 1/ON
	nn	3C	1	00 - 01	Rev HOLD1	0/OFF, 1/ON
	nn	3D	1	00 - 01	Rev PORTAMENTO	0/OFF, 1/ON
	nn	3E	1	00 - 01	Rev SOSTENUTO	0/OFF, 1/ON
	nn	3F	1	00 - 01	Rev SOFT PEDAL	0/OFF, 1/ON
	nn	40	1	00 - 01	Rev BANK SELECT	0/OFF, 1/ON
	nn	41	1	00 - 7F	SCALE TUNING C	-64 - +63 [cent]

MIDI Data Format

nn	42	1	00 - 7F	SCALE TUNING C#	-64 - +63 [cent]	40
nn	43	1	00 - 7F	SCALE TUNING D	-64 - +63 [cent]	40
nn	44	1	00 - 7F	SCALE TUNING D#	-64 - +63 [cent]	40
nn	45	1	00 - 7F	SCALE TUNING E	-64 - +63 [cent]	40
nn	46	1	00 - 7F	SCALE TUNING F	-64 - +63 [cent]	40
nn	47	1	00 - 7F	SCALE TUNING F#	-64 - +63 [cent]	40
nn	48	1	00 - 7F	SCALE TUNING G	-64 - +63 [cent]	40
nn	49	1	00 - 7F	SCALE TUNING G#	-64 - +63 [cent]	40
nn	4A	1	00 - 7F	SCALE TUNING A	-64 - +63 [cent]	40
nn	4B	1	00 - 7F	SCALE TUNING A#	-64 - +63 [cent]	40
nn	4C	1	00 - 7F	SCALE TUNING B	-64 - +63 [cent]	40
nn	4D	1	28 - 58	CAT PITCH CONTROL	-24 - +24 [semitones]	40
nn	4E	1	00 - 7F	CAT FILTER CONTROL	-9600 - +9450 [cent]	40
nn	4F	1	00 - 7F	CAT AMPLITUDE CONTROL	-64 - +63	40
nn	50	1	00 - 7F	CAT LFO PMOD DEPTH	0 - 127	00
nn	51	1	00 - 7F	CAT LFO FMOD DEPTH	0 - 127	00
nn	52	1	00 - 7F	CAT LFO AMOD DEPTH	0 - 127	00
nn	53	1	28 - 58	PAT PITCH CONTROL	-24 - +24 [semitones]	40
nn	54	1	00 - 7F	PAT FILTER CONTROL	-9600 - +9450 [cent]	40
nn	55	1	00 - 7F	PAT AMPLITUDE CONTROL	-64 - +63	40
nn	56	1	00 - 7F	PAT LFO PMOD DEPTH	0 - 127	00
nn	57	1	00 - 7F	PAT LFO FMOD DEPTH	0 - 127	00
nn	58	1	00 - 7F	PAT LFO AMOD DEPTH	0 - 127	00
nn	59	1	00 - 5F	AC1 CONTROLLER NUMBER	0 - 95	10
nn	5A	1	28 - 58	AC1 PITCH CONTROL	-24 - +24 [semitones]	40
nn	5B	1	00 - 7F	AC1 FILTER CONTROL	-9600 - +9450 [cent]	40
nn	5C	1	00 - 7F	AC1 AMPLITUDE CONTROL	-64 - +63	40
nn	5D	1	00 - 7F	AC1 LFO PMOD DEPTH	0 - 127	00
nn	5E	1	00 - 7F	AC1 LFO FMOD DEPTH	0 - 127	00
nn	5F	1	00 - 7F	AC1 LFO AMOD DEPTH	0 - 127	00
nn	60	1	00 - 5F	AC2 CONTROLLER NUMBER	0 - 95	11
nn	61	1	28 - 58	AC2 PITCH CONTROL	-24 - +24 [semitones]	40
nn	62	1	00 - 7F	AC2 FILTER CONTROL	-9600 - +9450 [cent]	40
nn	63	1	00 - 7F	AC2 AMPLITUDE CONTROL	-64 - +63	40
nn	64	1	00 - 7F	AC2 LFO PMOD DEPTH	0 - 127	00
nn	65	1	00 - 7F	AC2 LFO FMOD DEPTH	0 - 127	00
nn	66	1	00 - 7F	AC2 LFO AMOD DEPTH	0 - 127	00
nn	67	1	00 - 01	PORTAMENTO SWITCH	0/OFF, 1/ON	00
nn	68	1	00 - 7F	PORTAMENTO TIME	0 - 127	00
nn	69	1	00 - 7F	PITCH EG INITIAL LEVEL	-64 - +63	40
nn	6A	1	00 - 7F	PITCH EG ATTACK TIME	-64 - +63	40
nn	6B	1	00 - 7F	PITCH EG RELEASE LEVEL	-64 - +63	40
nn	6C	1	00 - 7F	PITCH EG RELEASE TIME	-64 - +63	40
nn	6D	1	01 - 7F	VELOCITY LIMIT LOW	1 - 127	01
nn	6E	1	01 - 7F	VELOCITY LIMIT HIGH	1 - 127	7F
TOTAL SIZE		3F				

nn = Part Number (0:1Part, 1:2Part, 2:3Part, ..., 15:16Part)

For the DRUM PART, the following parameters have no effect.

- SOFT PEDAL
- BANK SELECT LSB
- MONO/POLY
- SCALE TUNING
- PORTAMENTO
- PITCH EG INITIAL LEVEL
- PITCH EG ATTACK TIME
- PITCH EG RELEASE LEVEL
- PITCH EF RELEASE TIME
- POLY AFTER TOUCH

<Table 1-5>

MIDI Parameter Change table (DRUM SETUP) [XG]

Address (H)	Size (H)	Data (H)	Parameter	Description	Default (H)
3n rr	00	1 00 - 7F	PITCH COARSE	-64 - +63	40
3n rr	01	1 00 - 7F	PITCH FINE	-64 - +63 [cent]	40
3n rr	02	1 00 - 7F	LEVEL	0 - 127	Depends on the note
3n rr	03	1 00 - 7F	ALTERNATE GROUP	0/OFF, 1 - 127	"
3n rr	04	1 00 - 7F	PAN	0/random, 1/L63 - 64/C - 127/R63	"
3n rr	05	1 00 - 7F	REVERB SEND	0 - 127	"
3n rr	06	1 00 - 7F	CHORUS SEND	0 - 127	"
3n rr	07	1 00 - 7F	VARIATION SEND	0 - 127	7F

3n	rr	08	1	00 - 01	KEY ASSIGN	0/SINGLE, 1/MULTI	00
3n	rr	09	1	00 - 01	Rcv NOTE OFF	0/OFF, 1/ON	Depends on the note
3n	rr	0A	1	00 - 01	Rcv NOTE ON	0/OFF, 1/ON	01
3n	rr	0B	1	00 - 7F	FILTER CUTOFF FREQUENCY	-64 - +63	40
3n	rr	0C	1	00 - 7F	FILTER RESONANCE	-64 - +63	40
3n	rr	0D	1	00 - 7F	EG ATTACK RATE	-64 - +63	40
3n	rr	0E	1	00 - 7F	EG DECAY1 RATE	-64 - +63	40
3n	rr	0F	1	00 - 7F	EG DECAY2 RATE	-64 - +63	40
TOTAL SIZE		10					

[Note]

n: Drum number (0 - 1)

rr: note number (0D - 5B)

When XG system on or GM mode on messages are received, all Drum Setup parameters are initialized.

The Drum Setup Reset message can be used to initialize each Drum Setup parameter.

Selecting a Drum Set will cause the Drum Setup parameter values to be initialized.

<Table 2-1>

Parameter Bass Address

Model ID = 4B [QS300]

Bulk Dump				Description
Address				
	(H)	(M)		(L)
USER	11	00	00	User Normal Voice 1
NORMAL				:
VOICE	00	1F	00	User Normal Voice 32

<Table 2-2>

MIDI Bulk Dump table (USER NORMAL VOICE) [QS300]

Address (H)	Size (H)	Data (H)	Parameter	Description	Default (H)
11 nn	00	17D	20-7E	Voice Name	[Common]
:	07				
:	08			not used	
:	0A			"	
0B		01-03		Element Switch	1:Element 1 on, 2:Element 2 on, 3:Element 1 and 2 on
0C		00-7F		Voice Level	
:	0D			not used	
:	3C			"	
:	3D		00-7F	Wave Number High	[Element 1] bit13-bit7
3E		00-7F		Wave Number Low	bit6-bit0
3F		00-7F		Note Limit Low	
40		00-7F		Note Limit High	
41		00-7F		Velocity Limit Low	
42		00-7F		Velocity Limit High	
43		00-01		Filter EG Velocity Curve	
44		00-02		LFO Wave Select	0:saw, 1:tri, 2:S&H
45		00-01		LFO Phase Initialize	0:OFF, 1:ON
46		00-3F		LFO Speed	
47		00-7F		LFO Delay	
48		00-7F		LFO Fade Time	
49		00-3F		LFO PMD Depth	
4A		00-0F		LFO CMD Depth	
4B		00-1F		LFO AMD Depth	
4C		20-60		Note Shift	
4D		0E -72		Detune	
4E		00-05		Pitch Scaling	0:100%, 1:50%, 2:20%, 3:10%, 4:5%, 5:0%
4F		00-7F		Pitch Scaling Center Note	
50		00-03		Pitch EG Depth	0:1/2oct, 1:1oct, 2:2oct, 3:4oct
51		39-47		Velocity PEG Level Sensitivity	
52		39-47		Velocity PEG Rate Sensitivity	
53		39-47		PEG Rate Scaling	
54		00-7F		PEG Rate Scaling Center Note	
55		00-3F		PEG Rate 1	
56		00-3F		PEG Rate 2	
57		00-3F		PEG Rate 3	

MIDI Data Format

58	00-3F	PEG Rate 4	
59	00-7F	PEG Level 0	
5A	00-7F	PEG Level 1	
5B	00-7F	PEG Level 2	
5C	00-7F	PEG Level 3	
5D	00-7F	PEG Level 4	
5E	00-3F	Filter Resonance	
5F	00-07	Velocity Sensitivity	
60	00-7F	Cutoff Frequency	
61	00-7F	Cutoff Scaling Break Point 1	
62	00-7F	Cutoff Scaling Break Point 2	
63	00-7F	Cutoff Scaling Break Point 3	
64	00-7F	Cutoff Scaling Break Point 4	
65	00-7F	Cutoff Scaling Offset 1	
66	00-7F	Cutoff Scaling Offset 2	
67	00-7F	Cutoff Scaling Offset 3	
68	00-7F	Cutoff Scaling Offset 4	
69	39-47	Velocity FEG Level Sensitivity	
6A	39-47	Velocity FEG Rate Sensitivity	
6B	39-47	FEG Rate Scaling	
6C	00-7F	FEG Rate Scaling Center Note	
6D	00-3F	FEG Rate 1	
6E	00-3F	FEG Rate 2	
6F	00-3F	FEG Rate 3	
70	00-3F	FEG Rate 4	
71	00-7F	FEG Level 0	
72	00-7F	FEG Level 1	
73	00-7F	FEG Level 2	
74	00-7F	FEG Level 3	
75	00-7F	FEG Level 4	
76	00-7F	Element Level	
77	00-7F	Level Scaling Break Point 1	
78	00-7F	Level Scaling Break Point 2	
79	00-7F	Level Scaling Break Point 3	
7A	00-7F	Level Scaling Break Point 4	
7B	00-7F	Level Scaling Offset 1	
7C	00-7F	Level Scaling Offset 2	
7D	00-7F	Level Scaling Offset 3	
7E	00-7F	Level Scaling Offset 4	
7F	00-06	Velocity Curve	
80	00-0F	Pan	0 (Left)-14 (Right), 15:Scaling
81	39-47	AEG Rate Scaling	
82	00-7F	AEG Scaling Center Note	
83	00-0F	AEG Key on Delay	
84	00-7F	AEG Attack Rate	
85	00-7F	AEG Decay 1 Rate	
86	00-7F	AEG Decay 2 Rate	
87	00-7F	AEG Release Rate	
88	00-7F	AEG Decay 1 Level	
89	00-7F	AEG Decay 2 Level	
8A	00-7F	Address Offset High	bit13-bit7
8B	00-7F	Address Offset Low	bit6-bit0
8C	39-47	Resonance Sensitivity	
8D			[Element 2]
:			same as [Element 1]
DC			”
DD			”
:			[Element 3]
12C			not used
:			”
12D			”
:			[Element 4]
17C			not used
:			”
TOTAL SIZE	17D		”

nn=Voice Number (00-1F)

XG Normal Voice List

Bank Select MSB = 000, LSB = Bank Number

Voice names in bold typeface are voices that can be selected in the Disklavier.

The Disklavier can produce all the voices listed below, but can only display bank 0 voices.

Instrument Group	Program #	Bank #	Voice Name	Element	Instrument Group	Program #	Bank #	Voice Name	Element	Instrument Group	Program #	Bank #	Voice Name	Element	Instrument Group	Program #	Bank #	Voice Name	Element						
Piano	1	0	GrandPno	1	Organ	17	0	DrawOrgn	1	Bass	33	0	Aco.Bass	1	Ensemble	49	0	Strings1	1						
	1	1	GrndPnoK	1		32	32	DetDrwOr	2		40	40	JazzRthm	2		3	3	S.Strngs	2						
	18	18	MelloGrP	1		33	33	60sDrOr1	2		45	45	VXUpght	2		8	8	SlowStr	1						
	40	40	PianoStr	2		34	34	60sDrOr2	2		34	0	FngrBass	1		24	24	ArcoStr	2						
	41	41	Dream	2		35	35	70sDrOr1	2		18	18	FngDrk	2		35	35	60sStrng	2						
	2	0	BritePno	1		36	36	DrawOrg2	2		27	27	FlangeBa	2		40	40	Orchestr	2						
	1	1	BritPnoK	1		37	37	60sDrOr3	2		40	40	Ba&DstEG	2		41	41	Orchstr2	2						
	3	0	E.Grand	2		38	38	EvenBar	2		43	43	FngSlap	2		42	42	TremOrch	2						
	1	1	ElGrPnoK	2		40	40	16+2"2/3	2		45	45	FngBass2	2		45	45	VeloStr	2						
	32	32	Det.CP80	2		64	64	Organ Ba	1		65	65	ModAlem	2		50	0	Strings2	1						
	40	40	ElGrPno1	2		65	65	70sDrOr2	2		28	0	PickBass	1		3	3	S.SlwStr	2						
	41	41	ElGrPno2	2		66	66	CheezOrg	2		36	0	MutePkBa	1		8	8	LegatoSt	2						
	4	0	HnkyTonk	2		67	67	DrawOrg3	2		32	0	Fretless	1		40	40	Warm Str	2						
	1	1	HnkyTnkK	2		18	0	PercOrgn	1		32	32	Fretles2	2		41	41	Kingdom	2						
	5	0	E.Piano1	2		24	24	70sPcOr1	2		33	33	Fretles3	2		64	64	70s Tr	1						
	1	1	El.Pno1K	1		32	32	DetPrcOr	2		34	34	Fretles4	2		65	65	Str Ens3	1						
	18	18	MelloEP1	2		33	33	LiteOrg	2		96	96	SynFret1	2		51	0	Syn.Str1	2						
	32	32	Chor.EP1	2		37	37	PercOrg2	2		97	97	Smooth	2		27	27	ResoStr	2						
	40	40	HardELP	2		19	0	RockOrgn	2		37	0	SlapBas1	1		64	64	Syn Str4	2						
	45	45	VX EL.P1	2		64	64	RotaryOr	2		27	27	ResoSlap	1		65	65	SS Str	2						
	64	64	60sELP	1		65	65	SloRotar	2		32	32	PunchThm	2		52	0	Syn.Str2	2						
	6	0	E.Piano2	2		66	66	FstRotar	2		38	0	SlapBas2	1		53	0	ChoirAah	1						
	1	1	El.Pno2K	1		20	0	ChrchOrg	2		43	43	VeloSlap	2		3	3	S.Choir	2						
	32	32	Chor.EP2	2		32	32	ChurOrg3	2		0	0	SynBass1	1		16	16	Ch.Aahs2	2						
	33	33	DX Hard	2		35	35	ChurOrg2	2		18	18	SynBa1Dk	1		32	32	MelChoir	2						
	34	34	DXLegend	2		40	40	NotreDam	2		20	20	FastResB	1		40	40	ChoirStr	2						
	40	40	DX Phase	2		64	64	OrgFlute	2		24	24	AcidBass	1		54	0	VoiceOoh	1						
	41	41	DX+Analg	2		65	65	TrmOrgFl	2		35	35	Clv Bass	2		55	0	SynVoice	1						
	42	42	DXKotoEP	2		21	0	ReedOrgn	1		40	40	TeknoBa	2		40	40	SynVox2	2						
	45	45	VX EL.P2	2		40	40	Puff Org	2		64	64	Oscar	2		41	41	Choral	2						
	7	0	Harpsi.	1		22	0	Acordion	2		65	65	SqrBass	1		64	64	AnaVoice	1						
	1	1	Harpsi.K	1		32	32	AccordIt	1		66	66	RubberBa	2		56	0	Orch.Hit	2						
	25	25	Harpsi.2	2		23	0	Harmnica	1		96	96	Hammer	2		35	35	OrchHit2	2						
	35	35	Harpsi.3	2		32	32	Harmo 2	2		24	0	TangoAcd	2		64	64	Impact	2						
	8	0	Clavi.	2		24	0	TangoAcd	2		64	64	TngoAcd2	2		6	6	Trumpet	1						
	1	1	Clavi. K	1		16	16	NylonGtr	1		12	12	Seq Bass	2		17	17	Trumpet2	1						
	27	27	ClaviWah	2		25	25	NylonGt2	2		18	18	ClkSynBa	2		32	32	BriteTrp	2						
	64	64	PulseClv	1		43	43	NylonGt3	2		19	19	SynBa2Dk	1		32	32	WarmTrp	2						
	65	65	PierceCl	2		96	96	VelGtHrm	2		40	40	ModulrBa	2		41	41	DX Bass	2						
	Chromatic	9	0	Celesta		1	Guitar	25	0		NylonGtr	1	Strings	41		0	Violin	1	Brass	57	0	Trumpet	1		
	Percussion	10	0	Glocken		1	16	16	NylonGt2		1	8		8		SlowVln	1	12		12	Seq Bass	2			
	11	0	MusicBox	2		26	0	SteelGtr	1		35	35		12StrGtr		2	18	18		ClkSynBa	2	58	0	Trombone	1
	64	64	Orgel	2		16	16	SteelGt2	1		40	40		Nyln&Stl		2	19	19		SynBa2Dk	1	18	18	Trmbone2	2
	12	0	Vibes	1		35	35	12StrGtr	2		41	41		Stl&Body		2	40	40		ModulrBa	2	59	0	Tuba	1
	1	1	VibesK	1		40	40	Nyln&Stl	2		96	96		Mandolin		1	41	41		DX Bass	2	16	16	Tuba 2	1
	45	45	HardVibe	2		41	41	Stl&Body	2		27	0		Jazz Gtr		1	64	64		X WireBa	2	60	0	Mute.Trp	1
	13	0	Marimba	1		96	96	Mandolin	1		44	0		Contrabs		1	61	0		Fr.Horn	2	61	0	Fr.Horn	2
	1	1	MarimbaK	1		27	0	Jazz Gtr	1		45	0		Trem.Str		1	6	6		FrHrSolo	2	6	6	FrHrSolo	2
	64	64	SineMrmB	2		18	18	MelloGtr	1		8	8		SlowTrStr		1	32	32		FrHorn2	1	32	32	FrHorn2	1
	97	97	Balafon2	2		32	32	JazzAmp	2		40	40		Susp Str		2	37	37		HornOrch	2	62	0	BrasSect	1
	98	98	Log Drum	2		28	0	CleanGtr	1		40	40		Susp Str		2	35	35		Tp&TbSec	2	35	35	Tp&TbSec	2
	14	0	Xylophon	1		32	32	ChorusGt	2		41	41		Harp		1	40	40		BrssSec2	2	40	40	HiBrass	2
15	0	TubulBel	1	29	0	Mute.Gtr	1	47	0	Harp	1	42		42	MelloBrs	2	42	42		MelloBrs	2				
96	96	ChrchBel	2	40	40	FunkGtr1	2	40	40	YangChin	2	63		0	SynBras1	2	63	0		SynBras1	2				
97	97	Carillon	2	41	41	MuteStlG	2	44	44	Timpani	1	12		12	QuackBr	2	20	20		RezSynBr	2				
16	0	Dulcimer	1	43	43	FunkGtr2	2	45	45	Jazz Man	1	24		24	PolyBrss	2	24	24		PolyBrss	2				
35	35	Dulcimer2	2	45	45	Jazz Man	1	28	0	CleanGtr	1	27		27	SynBras3	2	27	27		SynBras3	2				
96	96	Cimbalom	2	30	0	Ovrdrive	1	43	43	ChorusGt	2	32		32	JumpBrss	2	32	32		JumpBrss	2				
97	97	Santur	2	43	43	Gt.Pinch	2	31	0	Dist.Gtr	1	45		45	AnaVelBr	2	45	45		AnaVelBr	2				
				31	0	Dist.Gtr	1	40	40	FeedbkGtr	2	64	64	AnaBrss1	2	64	0	SynBras2	1						
				40	40	FeedbkGtr	2	41	41	FeedbGt2	2	18	18	Soft Brs	2	40	40	SynBras4	2						
				41	41	MuteStlG	2	65	65	GtrHarmo	1	41	41	ChorBrss	2	41	41	ChorBrss	2						
				43	43	FunkGtr2	2	66	66	GtrHrmo2	1	45	45	VelBras2	2	45	45	VelBras2	2						
				45	45	Jazz Man	1					64	64	AnaBras2	2										

- | | | | | |
|-----------------------------|----------------------|--------------------|-----------------------|-----------------------|
| Bank 0 : (GM) | Bank 18 : Dark | Bank 34 : Detune 3 | Bank 43 : Velo-Switch | Bank 71 : Other wave |
| Bank 1 : Key Scale Planning | Bank 19 : Dark | Bank 35 : Octave 1 | Bank 45 : Velo-Xfade | Bank 72 : Other wave |
| Bank 3 : Stereo | Bank 20 : Resonant | Bank 36 : Octave 2 | Bank 64 : Other wave | Bank 96 : Other wave |
| Bank 6 : Single | Bank 24 : Attack | Bank 37 : 5th 1 | Bank 65 : Other wave | Bank 97 : Other wave |
| Bank 8 : Slow | Bank 24 : Release | Bank 38 : 5th 2 | Bank 66 : Other wave | Bank 98 : Other wave |
| Bank 12 : Fast Decay | Bank 27 : Reso Sweep | Bank 39 : Bend | Bank 67 : Other wave | Bank 99 : Other wave |
| Bank 14 : Double Attack | Bank 28 : Muted | Bank 40 : Tutti | Bank 68 : Other wave | Bank 100 : Other wave |
| Bank 16 : Bright | Bank 32 : Detune 1 | Bank 41 : Tutti | Bank 69 : Other wave | Bank 101 : Other wave |
| Bank 17 : Bright | Bank 33 : Detune 2 | Bank 42 : Tutti | Bank 70 : Other wave | |

Bank Select
MSB = 064, LSB = 000
SFX Voice

Instrument Group	Program #	Bank #	Voice Name	Element
Reed	65	0	SprnoSax	1
	66	0	Alto Sax	1
	40	0	Sax Sect	2
	43	0	HyprAlto	2
	67	0	TenorSax	1
	40	0	BrthTnSx	2
	41	0	SoftTenr	2
	64	0	TnrSax 2	1
	68	0	Bari.Sax	1
	69	0	Oboe	2
	70	0	Eng.Horn	1
	71	0	Bassoon	1
72	0	Clarinet	1	
Pipe	73	0	Piccolo	1
	74	0	Flute	1
	75	0	Recorder	1
	76	0	PanFlute	1
	77	0	Bottle	2
	78	0	Shakhchi	2
	79	0	Whistle	1
	80	0	Ocarina	1
Synth Lead	81	0	SquareLd	2
	6	0	Square 2	1
	8	0	LMSquare	2
	18	0	Hollow	1
	19	0	Shmoog	2
	64	0	Mellow	2
	65	0	SoloSine	2
	66	0	SineLead	1
	82	0	Saw.Lead	2
	6	0	Saw 2	1
	8	0	ThickSaw	2
	18	0	DynaSaw	1
	19	0	DigiSaw	2
	20	0	Big Lead	2
	24	0	HeavySyn	2
	25	0	WaspySyn	2
	40	0	PulseSaw	2
	41	0	Dr. Lead	2
	45	0	VeloLead	2
	96	0	Seq Ana	2
	83	0	Caliop.Ld	2
	65	0	Pure Pad	2
	84	0	Chiff Ld	2
	64	0	Rubby	2
85	0	Charan.Ld	2	
64	0	DistLead	2	
65	0	WireLead	2	
86	0	Voice Ld	2	
24	0	SynthAah	2	
64	0	VoxLead	2	
87	0	Fifth Ld	2	
35	0	Big Five	2	
88	0	Bass &Ld	2	
16	0	Big&Low	2	
64	0	Fat&Prky	2	
65	0	SoftWurl	2	
Synth Pad	89	0	NewAgePd	2
	64	0	Fantasy2	2
	90	0	Warm Pad	2
	16	0	ThickPad	2
	17	0	Soft Pad	2
	18	0	SinePad	2
	64	0	Horn Pad	2
	65	0	RotarStr	2
	91	0	PolySyPd	2
	64	0	PolyPd80	2
	65	0	ClickPad	2
	66	0	Ana Pad	2
	67	0	SquarPad	2

Instrument Group	Program #	Bank #	Voice Name	Element
Synth Pad	92	0	ChoirPad	2
	64	0	Heaven2	2
	66	0	Itopia	2
	67	0	CC Pad	2
	93	0	BowedPad	2
	64	0	Glacier	2
	65	0	GlassPad	2
	94	0	MetalPad	2
	64	0	Tine Pad	2
	65	0	Pan Pad	2
Synth Effects	95	0	Halo Pad	2
	96	0	Rain	2
	20	0	Shwimmer	2
	27	0	Converge	2
	64	0	PolarPad	2
	66	0	Celstial	2
	97	0	Rain	2
	45	0	ClaviPad	2
	64	0	HrmoRain	2
	65	0	AfrcnWnd	2
Synth Pad	98	0	SoundTrk	2
	27	0	Prologue	2
	64	0	Ancestrl	2
	99	0	Crystal	2
	12	0	SynDrCmp	2
	14	0	Popcorn	2
	18	0	TinyBell	2
	35	0	RndGlock	2
	40	0	GlockChi	2
	41	0	ClearBel	2
	42	0	ChorBell	2
	66	0	LoudGlok	2
	67	0	XmasBell	2
	68	0	VibeBell	2
69	0	DigiBell	2	
70	0	AirBells	2	
71	0	BellHarp	2	
72	0	Gamelmba	2	
Synth Pad	100	0	Atmosphr	2
	18	0	WarmAtms	2
	19	0	HollwRls	2
	40	0	NylonEP	2
	64	0	NylnHarp	2
	65	0	Harp Vox	2
	66	0	AtmosPad	2
	67	0	Planet	2
	101	0	Bright	2
	64	0	FantaBell	2
96	0	Smokey	2	
Synth Pad	102	0	Goblins	2
	64	0	GobSyn	2
	65	0	50sSciFi	2
	66	0	Ring Pad	2
	67	0	Ritual	2
	68	0	ToHeaven	2
	70	0	Night	2
	71	0	Glisten	2
	96	0	BelChoir	2
	103	0	Echoes	2
8	0	EchoPad2	2	
14	0	Echo Pan	2	
64	0	EchoBell	2	
65	0	Big Pan	2	
66	0	SynPiano	2	
67	0	Creation	2	
68	0	Stardust	2	
69	0	Reso Pan	2	
104	0	Sci-Fi	2	
64	0	Starz	2	

Instrument Group	Program #	Bank #	Voice Name	Element
Ethnic	105	0	Sitar	1
	32	0	DetSitar	2
	35	0	Sitar 2	2
	96	0	Tambra	2
	97	0	Tamboura	2
	106	0	Banjo	1
	28	0	MuteBnjo	1
	96	0	Rabab	2
	97	0	Gopichnt	2
	98	0	Oud	2
	107	0	Shamisen	1
	108	0	Koto	1
	96	0	T. Koto	2
	97	0	Kanoon	2
109	0	Kalimba	1	
110	0	Bagpipe	2	
111	0	Fiddle	1	
112	0	Shanai	1	
64	0	Shanai2	1	
96	0	Pungi	1	
97	0	Hichriki	2	
Percussive	113	0	TnklBell	2
	96	0	Bonang	2
	97	0	Gender	2
	98	0	Gamelan	2
	99	0	S.Gamlan	2
	100	0	Rama Cym	2
	101	0	AsianBel	2
	114	0	Agogo	2
	115	0	SteelDrum	2
	97	0	GlasPerc	2
	98	0	ThaiBell	2
	116	0	WoodBlok	1
	96	0	Castanet	1
	117	0	TaikoDrum	1
	96	0	Gr.Cassa	1
	118	0	MelodTom	2
	64	0	Mel Tom2	1
	65	0	Real Tom	2
66	0	Rock Tom	2	
119	0	Syn.Drum	1	
64	0	Ana Tom	1	
65	0	ElecPerc	2	
120	0	RevCymb	1	
Sound Effects	121	0	FretNoiz	2
	122	0	BrthNoiz	2
	123	0	Seashore	2
	124	0	Tweet	2
	125	0	Telephone	1
	126	0	Helicptr	1
	127	0	Applause	1
	128	0	Gunshot	1

Program #	MSB=064 LSB=000	Element	Program #	MSB=064 LSB=000	Element
1	CuttingNz	1	65	Tel.Dial	1
2	CttingNz2	2	66	DoorSqek	1
3			67	Door Slam	1
4	Str Slap	1	68	Scratch	1
5			69	Scratch 2	2
6			70	WindChm	1
7			71	Telphon2	1
8			72		
9			73		
10			74		
11			75		
12			76		
13			77		
14			78		
15			79		
16			80		
17	Fl.KClick	1	81	CarEngin	1
18			82	Car Stop	1
19			83	Car Pass	1
20			84	CarCrash	1
21			85	Siren	2
22			86	Train	1
23			87	Jetplane	2
24			88	Starship	2
25			89	Burst	2
26			90	Coaster	2
27			91	SbMarine	2
28			92		
29			93		
30			94		
31			95		
32			96		
33	Rain	1	97	Laughing	1
34	Thunder	1	98	Scream	1
35	Wind	1	99	Punch	1
36	Stream	2	100	Heart	1
37	Bubble	2	101	FootStep	1
38	Feed	2	102		
39			103		
40			104		
41			105		
42			106		
43			107		
44			108		
45			109		
46			110		
47			111		
48			112		
49	Dog	1	113	MchinGun	1
50	Horse	1	114	LaserGun	2
51	Bird 2	1	115	Xplosion	2
52			116	FireWork	2
53			117		
54			118		
55	Ghost	2	119		
56	Maou	2	120		
57			121		
58			122		
59			123		
60			124		
61			125		
62			126		
63			127		
64			128		

█ : No Sound

TG300B Normal Voice List

Bank Select MSB = Bank Number, LSB = 000

Instrument Group	Program #	Bank #	Voice Name	Element	Instrument Group	Program #	Bank #	Voice Name	Element	Instrument Group	Program #	Bank #	Voice Name	Element								
Piano	1	0	GrandPno	1	Organ	17	0	DrawOrgn	1	Guitar	29	0	Mute.Gtr	1								
		8	GrndPnoK	1			1	70sDrOr1	2			8	FunkGtr1	2								
		16	MelloGrP	1			8	DetDrwOr	2			16	FunkGtr2	2								
		126	A-Piano1	2			9	70sDrOr2	2			126	A-Bass	2								
	2	0	BritePno	1			16	60sDrOr1	2		127	synbass1	1	30	0	Ovrdrive	1					
		8	BritPnoK	1			17	60sDrOr2	2		126	Choir-1	1		126	Choir-1	1					
		126	A-Piano2	2			18	60sDrOr3	2		127	synbass2	1		127	synbass2	1					
		127	a.piano2	1			32	DrawOrg2	2		31	Dist.Gtr	1		8	FeedbkGt	2					
	3	0	E.Grand	2			33	EvenBar	2		9	FeedbkGt2	2	126	Choir-2	1						
		8	ElGrPno1	2			40	Organ Ba	1		127	synbass3	2	32	GtrHarmo	1						
		126	A-Piano3	2			126	Slap-2	2		8	GtFeedbk	1	126	Choir-3	2						
		127	a.piano3	1			127	harpsi1	1		127	synbass4	1	127	synbass4	1						
	4	0	HnkyTonk	2			18	0	PercOrgn		1	33	Aco.Bass	1	34	0	FngrBass	1				
		8	HnkyTnkK	2			1	70sPcOr1	2		126	Choir-4	2	1		FngBass2	2					
		126	A-Piano4	2			8	DetPrcOr	2		127	newagepd	2	126		Strngs-1	2					
		127	e.piano4	1			32	PercOrg2	2		127	synharmo	2	127		synharmo	2					
5	0	E.Piano1	2	126	Slap-3	2	19	0	RockOrgn	2	35	0	PickBass	1								
	8	Chor.EP1	2	127	harpsi2	2		8	ChrchOrg	1		8	MutePkBa	1								
	16	VX EL.P1	2	8	ChurOrg2	2		16	ChurOrg3	2		126	Strngs-2	2								
	24	60sEL.P	1	24	OrgFlute	2		127	clavi1	2		127	choir pd	2								
6	25	HardEL.P	2	16	TrmOrgFl	2	20	0	ReedOrgn	1	36	0	SlapBas1	1								
	26	MelloEP1	2	126	Slap-5	2		8	AccordIt	2		1	Fretless	1								
	32	El.Pno1K	1	127	clavi1	1		126	Slap-7	2		8	ResoSlap	1								
	126	A-Piano5	1	127	harpsi3	2		127	clavi3	1		126	Strngs-4	2								
7	0	E.Piano2	2	21	0	ReedOrgn	1	23	0	Harmnica	1	37	0	SlapBas2	1							
	8	Chor.EP2	2	126	Slap-6	2	1		Harmo 2	2	126		E-Organ1	2	8	LegatoSt	2					
	16	VX EL.P2	2	127	clavi2	2	127		celesta1	1	127		atmosphr	2	9	Warm Str	2					
	24	DX Hard	2	0	Acordion	2	24		0	TangoAcid	1		126	TP/TRB-2	2	10	S.SlwStr	2				
32	El.Pno2K	1	8	AccordIt	2	126		Finger-1	1	127	strsect1	1	126	TP/TRB-2	2							
126	A-Piano6	1	126	Slap-8	2	127		celesta2	1	8	Strings2	1	127	pizz.str	1							
127	e.piano3	1	127	clavi1	1	25		0	NylonGtr	1	1	70s Str	1	50	0	Strings2	1					
8	0	Clavi.	2	8	ChurOrg3		2	1	Ukulele	1	1	LegatoSt	2		1	70s Str	1					
	8	Clavi. K	1	16	OrgFlute		2	8	SteelGtr	1	8	Warm Str	2		8	LegatoSt	2					
	126	A-Piano7	1	126	Slap-5		2	8	12StrGtr	2	9	S.SlwStr	2		9	Warm Str	2					
	127	e.piano4	1	127	clavi1	1	9	Nyln&Stl	2	10	TP/TRB-3	1	10	S.SlwStr	2							
Chromatic Percussion	9	0	Celesta	1	Guitar	25	0	NylonGtr	1	Bass	33	0	Aco.Bass	1	38	0	SlapBas2	1				
		126	E-Piano2	2			1	Harmo 2	2			126	E-Organ1	2		126	E-Organ1	2	126	atmosphr	2	
		127	e.organ1	2			126	Slap-8	2			127	celesta1	1		127	atmosphr	2	127	atmosphr	2	
		127	e.organ1	2			127	celesta2	1			39	0	SynBass1		1	1	SynBass1	1	1	SynBass1	1
	10	0	Glocken	1			1	Finger-2	2		8		SynBa1Dk	1	8	AcidBass	1	8	AcidBass	1		
		126	E-Piano3	2			126	Slap-8	2		9		FastResB	1	9	FastResB	1	9	FastResB	1		
		127	e.organ2	2			127	celesta1	1		10		TeknoBa	2	10	TeknoBa	2	10	TeknoBa	2		
		127	e.organ2	2			127	celesta2	1		16	ResoBass	1	16	ResoBass	1	16	ResoBass	1			
	11	0	MusicBox	2			21	0	ReedOrgn		1	126	E-Organ2	2	40	0	SynBass2	2	39	0	SynBass1	1
		126	A-Guitr1	1			126	Slap-6	2		1	Harmo 2	2	1		ClkSynBa	2	1		SynBa1Dk	1	
		127	e.organ3	1			127	clavi2	2		2	ModulrBa	2	2		ModulrBa	2	2		SynBa1Dk	1	
		127	e.organ3	1			127	clavi2	2		3	Seq Bass	2	3		Seq Bass	2	3		Seq Bass	2	
	12	0	Vibes	1			22	0	Acordion		2	8	DX Bass	2	40	1	ClkSynBa	2	8	DX Bass	2	
		1	HardVibe	2			8	AccordIt	2		8	X WireBa	2	8		DX Bass	2	8	DX Bass	2		
		8	VibesK	1			126	Slap-7	2		9	RubberBa	2	9		X WireBa	2	9	X WireBa	2		
		126	A-Guitr2	2			127	clavi3	1		16	RubberBa	2	16		RubberBa	2	16	RubberBa	2		
13	127	e.organ4	1	23	0	Harmnica	1	17	SynBa2Dk	1	40	2	ModulrBa	2	17	SynBa2Dk	1					
	0	Marimba	1	1	Harmo 2	2	18	MelloSB1	1	18		MelloSB1	1	18	MelloSB1	1						
	8	MarimbaK	1	126	Slap-8	2	126	celesta1	1	19		SmthBa 2	2	19	SmthBa 2	2						
	17	Balafon2	2	127	celesta2	1	24	0	TangoAcid	1		126	E-Organ3	2	126	E-Organ3	2					
24	Log Drum	2	0	Acordion	2	1		Jazz Gtr	1	127	synfunny	1	127	synfunny	1							
126	A-Guitr3	2	8	AccordIt	2	1		MelloGtr	1	1	ClkSynBa	2	1	ClkSynBa	2							
127	pipeorg1	2	126	Slap-8	2	8		PdlSteel	1	2	ModulrBa	2	2	ModulrBa	2							
14	0	Xylophon	1	26	0	SteelGtr	1	126	Picked-1	1	40	3	Seq Bass	2	3	Seq Bass	2					
	126	E-Guitr1	2	8	12StrGtr	2	126	synbras2	2	3		Seq Bass	2	3	Seq Bass	2						
	127	pipeorg2	2	9	Nyln&Stl	2	127	synbras3	2	8		DX Bass	2	8	DX Bass	2						
	127	pipeorg2	2	16	Mandolin	2	127	synbras4	2	9		X WireBa	2	9	X WireBa	2						
15	0	TubulBel	1	32	SteelGtr2	2	27	0	Jazz Gtr	1	40	1	ClkSynBa	2	16	RubberBa	2					
	8	ChrchBel	2	1	MelloGtr	1		1	MelloGtr	1		16	RubberBa	2	16	RubberBa	2					
	9	Carillon	2	8	PdlSteel	1		8	PdlSteel	1		17	SynBa2Dk	1	17	SynBa2Dk	1					
	126	E-Guitr2	2	126	Picked-2	2		126	synbras3	2		18	MelloSB1	1	18	MelloSB1	1					
16	127	pipeorg3	2	127	synbras3	2	28	0	CleanGtr	1	40	2	ModulrBa	2	19	SmthBa 2	2					
	0	Dulcimer	1	8	ChorusGt	2		1	CleanGtr	1		2	ModulrBa	2	19	SmthBa 2	2					
	1	Dulcimr2	2	126	FretlsBs	1		8	ChorusGt	2		2	ModulrBa	2	126	E-Organ3	2					
	8	Cimbalom	2	127	synbras4	2		126	FretlsBs	1		126	E-Organ3	2	127	synfunny	1					

MIDI Data Format

Instrument Group	Program #	Bank #	Voice Name	Element	Instrument Group	Program #	Bank #	Voice Name	Element	Instrument Group	Program #	Bank #	Voice Name	Element	Instrument Group	Program #	Bank #	Voice Name	Element	
Brass	57	0	Trumpet	1	Synth Lead	81	0	SquareLd	2	Synth Effects	97	0	Rain	2	Percussive	113	0	TnkIBell	2	
	1	1	Trumpet2	1		1	1	Square 2	1		1	1	1	HrmoRain		2	8	Bonang	2	
	24	2	BriteTrp	2		2	2	Hollow	1		2	2	2	2		AfrcnWnd	2	9	Gender	2
	25	2	WarmTrp	2		3	3	Mellow	2		2	2	2	8		ClaviPad	2	10	Gamelan	2
	126	1	Sax-3	1		4	4	SoloSine	2		2	2	2	127		brssect2	2	11	S.Gamlan	2
	127	1	contrabs	1		5	5	Shmoog	2		2	2	2	0		SoundTrk	2	16	Rama Cym	2
	58	0	Trombone	1		6	6	LMSquare	2		2	2	2	1		Ancestrl	2	127	timpani	1
	1	1	Trmbone2	2		8	8	SineLead	1		1	1	2	2		Prologue	2	0	Agogo	2
	126	2	Sax-4	2		127	127	sax3	1		1	1	127	vibe1		1	127	melotom	1	
	127	1	harp 1	1		82	0	Saw.Lead	2		2	2	0	Crystal		2	0	SteelDrum	2	
	59	0	Tuba	1		1	1	Saw 2	1		1	1	1	SynMalet		1	127	deepsnar	1	
	1	1	Tuba 2	1		2	2	PulseSaw	2		2	2	2	SftCryst		2	0	WoodBlok	1	
	126	1	Brass-1	1		3	3	ThickSaw	2		2	2	3	RndGlock		2	8	Castanet	1	
	127	1	harp 2	1		4	4	Big Lead	2		2	2	4	LoudGlok		2	127	e.perc1	1	
	60	0	Mute.Trp	1		5	5	VeloLead	2		2	2	5	GlockChi		2	0	TaikoDrm	1	
	126	1	Brass-2	1		6	6	HeavySyn	2		2	2	6	ClearBel		2	8	Gr.Cassa	1	
	127	1	guitar 1	1		7	7	DynaSaw	1		1	1	7	XmasBell		2	127	e.perc2	1	
	61	0	Fr.Horn	2		8	8	Dr. Lead	2		2	2	8	VibeBell		2	0	MelodTom	2	
	1	2	FrHorn2	2		16	16	WaspySyn	2		2	2	9	DigiBell		2	1	Real Tom	2	
	8	2	FrHrSolo	2		127	127	sax4	1		1	1	16	ChorBell		2	8	Mel Tom2	2	
	16	1	HornOrch	1		83	0	CalioLd	2		2	2	17	AirBells		2	9	Rock Tom	2	
	126	2	Brass-3	2		2	2	Pure Pad	2		2	2	18	BellHarp		2	127	taiko	1	
	127	1	guitar 2	1		127	127	clarint1	1		1	1	19	Gamelmba		2	0	Syn.Drum	1	
	62	0	BrasSect	1		84	0	Chiff Ld	2		2	2	127	vibe2		1	8	Ana Tom	1	
	8	2	BrssSec2	2		127	127	clarint2	1		1	1	0	Atmosphr		2	9	ElecPerc	2	
	126	2	Brass-4	2		85	0	CharanLd	2		2	2	1	WarmAtms		2	127	taikorim	1	
	127	2	elecgr1	2		8	8	DistLead	2		2	2	2	NylnHarp		2	0	RevCymb1	1	
	63	0	SynBras1	2		127	127	oboe	1		1	1	3	Harp Vox		2	127	cymbal	2	
	1	2	PolyBrss	2		86	0	Voice Ld	2		2	2	4	HollwRls		2	0	FretNoiz	2	
	8	2	SynBras3	2		127	127	ooboe	1		1	1	5	NylonEP		2	1	CuttingNz	1	
	9	2	QuackBr	2		87	0	Fifth Ld	2		2	2	6	AtmosPad		2	2	Str Slap	1	
	16	2	AnaBrss1	2		1	1	Big Five	2		2	2	127	symallet		1	3	CtngNz2	2	
	126	2	Brass-5	2		127	127	bassoon	1		1	1	0	Bright		2	127	castanet	1	
	127	2	elecgr2	2		88	0	Bass & Ld	2		2	2	127	maletwin		2	0	BrthNoiz	2	
	64	0	SynBras2	1		1	1	Big&Low	2		2	2	0	Goblins		2	1	Fl.KClk	1	
	1	2	Soft Brs	2		2	2	Fat&Prky	2		2	2	1	GobSyn		2	127	triangle	1	
	8	2	SynBras4	2		127	127	harmnica	1		1	1	2	50sSciFi		2	0	Seashore	2	
	16	2	AnaBrss2	2		89	0	NewAgePd	2		2	2	127	glocken		2	1	Rain	1	
	17	2	VelBras2	2		1	1	Fantasy2	2		2	2	0	Echoes		2	2	Thunder	1	
	126	1	Orch-Hit	1		127	127	trumpet1	1		1	1	1	EchoBell		2	3	Wind	1	
	127	1	sitar	1		90	0	Warm Pad	2		2	2	2	Echo Pan		2	4	Stream	2	
	65	0	SprnoSax	1		1	1	ThickPad	2		2	2	3	EchoPad2		2	5	Bubble	2	
	127	1	a.bass 1	1		2	2	Horn Pad	2		2	2	4	Big Pan		2	127	orchchit	1	
	66	0	Alto Sax	1		3	3	RotarStr	2		2	2	6	SynPiano		2	0	Tweet	2	
	8	2	HyrAlto	2		4	4	Soft Pad	2		2	2	127	tubulbel		1	1	Dog	1	
127	1	a.bass 2	1	127	127	trumpet2	1	1	1	0	Sci-Fi	2	2	Horse	1					
67	0	TnrSax 2	2	91	0	PolySyPd	2	2	2	1	Starz	2	3	Bird 2	1					
8	2	BrthTnSx	2	1	1	PolyPd80	2	2	2	127	xylophon	1	127	telephone	1					
127	1	e.bass 1	1	127	127	trmbone1	2	2	2	105	0	Sitar	1	0	Telephone	1				
68	0	Bari.Sax	1	92	0	ChoirPad	2	2	2	1	Sitar 2	2	1	Tel.Dial	1					
127	1	e.bass 2	1	1	1	Heaven2	2	2	2	2	DetSitar	2	2	DoorSqek	1					
69	0	Oboe	2	127	127	trmbone2	2	2	2	8	Tambra	2	3	DoorSlam	1					
127	1	slapbas1	1	93	0	BowedPad	2	2	2	16	Tamboura	2	4	Scratch	1					
70	0	Eng.Horn	1	127	127	fr.horn1	1	1	1	127	marimba	2	5	WindChm	1					
127	1	slapbas2	1	94	0	MetalPad	2	2	2	0	Banjo	1	6	Scratch2	2					
71	0	Bassoon	1	1	1	Tine Pad	2	2	2	1	MuteBnjo	1	127	bird	1					
127	1	fretles1	1	2	2	Pan Pad	2	2	2	8	Rabab	2	0	Helicptr	1					
72	0	Clarinet	1	127	127	fr.horn2	2	2	2	16	Gopichnt	2	1	CarEngin	1					
127	1	fretles2	1	95	0	Halo Pad	2	2	2	24	Oud	2	2	Car Stop	1					
73	0	Piccolo	1	127	127	tuba	2	2	2	127	koto	1	3	Car Pass	1					
127	1	flute1	1	96	0	SweepPad	2	2	2	0	Shamisen	1	4	CarCrash	1					
74	0	Flute	1	1	1	PolarPad	2	2	2	127	sho	2	5	Siren	2					
127	1	flute2	1	8	8	Converge	2	2	2	0	Koto	1	6	Train	1					
75	0	Recorder	1	9	9	Shwimmer	2	2	2	8	T. Koto	2	7	Jetplane	2					
127	1	piccolo1	1	10	10	Celstial	2	2	2	16	Kanoon	2	8	Starship	2					
76	0	PanFlute	1	127	127	brssect1	1	1	1	127	shakhchi	2	9	Burst	2					
127	2	piccolo2	2	77	0	Bottle	2	2	2	0	Kalimba	1	16	Coaster	2					
77	0	Bottle	2	127	127	recorder	1	1	1	127	whistle1	2	127	jam	1					
127	1	recorder	1	78	0	Shakhchi	2	2	2	0	Bagpipe	2	0	Applause	1					
78	0	Shakhchi	2	127	127	panpipes	2	2	2	127	whistle2	1	1	Laughing	1					
127	2	panpipes	2	79	0	Whistle	1	1	1	0	Fiddle	1	2	Scream	1					
79	0	Whistle	1	127	127	sax1	2	2	2	127	bottle	2	3	Punch	1					
127	2	sax1	2	80	0	Ocarina	1	1	1	0	Shanai	1	4	Heart	1					
127	1	sax2	1	1	1	Pungi	1	1	1	1	Shanai2	1	5	FootStep	1					
73	0	Piccolo	1	8	8	Hichriki	2	2	2	127	breath	2	127	efctwatr	2					
127	1	flute1	1	16	16	Hichriki	2	2	2	0	Gunshot	1	0	MchinGun	1					
74	0	Flute	1	127	127	breath	2	2	2	1	LaserGun	1	2	LaserGun	1					
127	1	flute2	1	73	0	Piccolo	1	1	1	2	Xplosion	2	3	Xplosion	2					
75	0	Recorder	1	127	127	recorder	1	1	1	127	efctjngl	2	127	efctjngl	2					
127	1	piccolo1	1	74	0	Flute	1	1	1	0	MchinGun	1	1	MchinGun	1					
76	0	PanFlute	1	127	127	flute2	1	1	1	2	LaserGun	1	2	LaserGun	1					
127	2	piccolo2	2	75	0	Recorder	1	1	1	3	Xplosion	2	3	Xplosion	2					
77	0	Bottle	2	127	127	recorder	1	1	1	127	efctjngl	2	127	efctjngl	2					
127	1	recorder	1	76	0	PanFlute	1	1	1	0	MchinGun	1	1	MchinGun	1					
78	0	Shakhchi	2	127	127	panpipes	2	2	2	2	LaserGun	1	2	LaserGun	1					
127	2	panpipes	2	77	0	Whistle	1	1	1	3	Xplosion	2	3	Xplosion	2					
79	0	Whistle	1	127	127	sax1	2	2	2	127	efctjngl	2	127	efctjngl	2					
127	2	sax1	2	80	0	Ocarina	1	1	1	0	MchinGun	1	1	MchinGun	1					
127	1	sax2	1	1	1	Pungi	1	1	1	2	LaserGun	1	2	LaserGun	1					
73	0	Piccolo	1	8	8	Hichriki	2	2	2	3	Xplosion	2	3	Xplosion	2					
127	1	flute1	1	16	16	Hichriki	2	2	2	127	efctjngl	2	127	efctjngl	2					
74	0	Flute	1	127	127	breath	2	2	2	0	MchinGun	1	1	MchinGun	1					
127	1	flute2	1	73	0	Piccolo	1	1	1	2	LaserGun	1	2	LaserGun	1					

XG Drum Voice List

Bank Select MSB = Bank Number, LSB = 000

Drum kit names in bold typeface are those that can be selected in the Disklavier.

Bank	127				127	127	127	127	127	127	127	126	126	
Program #	1				2	9	17	25	26	33	41	49	1	2
Note#	Note	Key off	Alternate assign	Standard Kit	Standard2 Kit	Room Kit	Rock Kit	Electro Kit	Analog Kit	Jazz Kit	Brush Kit	Classic Kit	SFX 1	SFX 2
13	C# -1		3	Surdo Mute										
14	D -1		3	Surdo Open										
15	D# -1			Hi Q										
16	E -1			Whip Slap										
17	F -1		4	Scratch Push										
18	F# -1		4	Scratch Pull										
19	G -1			Finger Snap										
20	G# -1			Click Noise										
21	A -1			Metronome Click										
22	A# -1			Metronome Bell										
23	B -1			Seq Click L										
24	C 0			Seq Click H										
25	C# 0			Brush Tap										
26	D 0	O		Brush Swirl L										
27	D# 0			Brush Slap										
28	E 0	O		Brush Swirl H				Reverse Cymbal	Reverse Cymbal					
29	F 0	O		Snare Roll	Snare Roll 2									
30	F# 0			Castanet				Hi Q	Hi Q					
31	G 0			Snare L	Snare L 2		SD Rock M	Snare M	SD Rock H		Brush Slap L			
32	G# 0			Sticks										
33	A 0			Bass Drum L			Bass Drum M	Bass Drum H 4	Bass Drum M			Bass Drum L2		
34	A# 0			Open Rim Shot	Open Rim Shot 2									
35	B 0			Bass Drum M	Bass Drum M 2		Bass Drum H 3	BD Rock	BD Analog L			Gran Cassa		
36	C 1			Bass Drum H	Bass Drum H 2		BD Rock	BD Gate	BD Analog H	BD Jazz	BD Soft	Gran Cassa Mute	Guitar Cutting Noise	Dial Tone
37	C# 1			Side Stick					Analog Side Stick				Guitar Cutting Noise 2	Door Creaking
38	D 1			Snare M	Snare M 2	SD Room L	SD Rock	SD Rock L	Analog Snare L		Brush Slap M	Marching Sn M	Door Slam	Scratch
39	D# 1			Hand Clap									String Slap	Scratch 2
40	E 1			Snare H	Snare H 2	SD Room H	SD Rock Rim	SD Rock H	Analog Snare H		Brush Tap H	Marching Sn H	Scratch 2	Windchime
41	F 1			Floor Tom L		Room Tom 1	Rock Tom 1	E Tom 1	Analog Tom 1	Jazz Tom 1	Brush Tom 1	Jazz Tom 1		Telephone Ring 2
42	F# 1		1	Hi-Hat Closed					Analog HH Closed 1					
43	G 1			Floor Tom H		Room Tom 2	Rock Tom 2	E Tom 2	Analog Tom 2	Jazz Tom 2	Brush Tom 2	Jazz Tom 2		
44	G# 1		1	Hi-Hat Pedal					Analog HH Closed 2					
45	A 1			Low Tom		Room Tom 3	Rock Tom 3	E Tom 3	Analog Tom 3	Jazz Tom 3	Brush Tom 3	Jazz Tom 3		
46	A# 1		1	Hi-Hat Open					Analog HH Open					
47	B 1			Mid Tom L		Room Tom 4	Rock Tom 4	E Tom 4	Analog Tom 4	Jazz Tom 4	Brush Tom 4	Jazz Tom 4		
48	C 2			Mid Tom H		Room Tom 5	Rock Tom 5	E Tom 5	Analog Tom 5	Jazz Tom 5	Brush Tom 5	Jazz Tom 5		
49	C# 2			Crash Cymbal 1					Analog Cymbal				Hand Cym.Open L	
50	D 2			High Tom		Room Tom 6	Rock Tom 6	E Tom 6	Analog Tom 6	Jazz Tom 6	Brush Tom 6	Jazz Tom 6		
51	D# 2			Ride Cymbal 1									Hand Cym.Closed L	
52	E 2			Chinese Cymbal										
53	F 2			Ride Cymbal Cup									FL Key Click	Engine Start
54	F# 2			Tambourine										Tire Screech
55	G 2			Splash Cymbal										Car Passing
56	G# 2			Cowbell					Analog Cowbell					Crash
57	A 2			Crash Cymbal 2								Hand Cym.Open H		Siren
58	A# 2			Vibraslap										Train
59	B 2			Ride Cymbal 2								Hand Cym.Closed H		Jetplane
60	C 3			Bongo H										Starship
61	C# 3			Bongo L										Burst Noise
62	D 3			Conga H Mute					Analog Conga H					Coaster
63	D# 3			Conga H Open					Analog Conga M					SbMarine
64	E 3			Conga L					Analog Conga L					
65	F 3			Timbale H										
66	F# 3			Timbale L										
67	G 3			Agogo H										
68	G# 3			Agogo L									Rain	Laughing
69	A 3			Cabasa									Thunder	Screaming
70	A# 3			Maracas					Analog Maracas				Wind	Punch
71	B 3	O		Samba Whistle H									Stream	Heartbeat
72	C 4	O		Samba Whistle L									Bubble	Footsteps
73	C# 4			Guiro Short									Feed	
74	D 4	O		Guiro Long										
75	D# 4			Claves					Analog Claves					
76	E 4			Wood Block H										
77	F 4			Wood Block L										
78	F# 4			Cuica Mute				Scratch Push	Scratch Push					
79	G 4			Cuica Open				Scratch Pull	Scratch Pull					
80	G# 4		2	Triangle Mute										
81	A 4		2	Triangle Open										
82	A# 4			Shaker										
83	B 4			Jingle Bell										
84	C 5			Bell Tree									Dog	Machine Gun
85	C# 5												Horse Gallop	Laser Gun
86	D 5												Bird 2	Explosion
87	D# 5													FireWork
88	E 5													
89	F 5													
90	F# 5												Ghost	
91	G 5												Maou	

: Same as Standard kit
 : No sound

TG300B Drum Voice List

Program #	Note#	Alternate assign	1	9	17	25	26	33	41	49	57	128
			Standard Kit	Room Kit	Power Kit	Electro Kit	Analog Kit	Jazz Kit	Brush Kit	Orchestra Kit	SFX Set	C/M Kit
25	C# 0		Snare Roll									
26	D 0		Finger Snap									
27	D# 0		Hi Q							Hi-Hat Closed		
28	E 0		Whip Slap							Hi-Hat Pedal		
29	F 0	7	Scratch Push							Hi-Hat Open		
30	F# 0	7	Scratch Pull							Ride Cymbal 1		
31	G 0		Sticks									
32	G# 0		Click Noise									
33	A 0		Metronome Click									
34	A# 0		Metronome Bell									
35	B 0		Bass Drum M							BD Jazz		
36	C 1		Bass Drum H		BD Power	BD Electronic	BD Analog H	BD Jazz	BD Soft	Gran Cassa		
37	C# 1		Side Stick				Analog Side Stick					
38	D 1		Snare M		SD Power	SD Electronic	Analog Snare L.		Brush Tap	Concert SD		
39	D# 1		Hand Clap						Brush Slap	Castanet	High-Q	
40	E 1		Snare H			SD Power			Brush Swirl	Concert SD	Slap	SD Electro
41	F 1		Floor Tom L.	Room Tom 1	Room Tom 1	E Tom 1	Analog Tom 1	Jazz Tom 1	Jazz Tom 1	Timpani F	Scratch Push	
42	F# 1	1	Hi-Hat Closed				Analog HH Closed 1			Timpani F#	Scratch Pull	
43	G 1		Floor Tom H	Room Tom 2	Room Tom 2	E Tom 2	Analog Tom 2	Jazz Tom 2	Jazz Tom 2	Timpani G	Sticks	
44	G# 1	1	Hi-Hat Pedal				Analog HH Closed 2			Timpani G#	Square Click	Hi-Hat Open 1
45	A 1		Low Tom	Room Tom 3	Room Tom 3	E Tom 3	Analog Tom 3	Jazz Tom 3	Jazz Tom 3	Timpani A	Metronome Click	
46	A# 1	1	Hi-Hat Open				Analog HH Open			Timpani A#	Metronome Bell	Hi-Hat Open 2
47	B 1		Mid Tom L.	Room Tom 4	Room Tom 4	E Tom 4	Analog Tom 4	Jazz Tom 4	Jazz Tom 4	Timpani B	Guitar Fret Noise	
48	C 2		Mid Tom H	Room Tom 5	Room Tom 5	E Tom 5	Analog Tom 5	Jazz Tom 5	Jazz Tom 5	Timpani C	Guitar Cutting Down	
49	C# 2		Crash Cymbal 1				Analog Cymbal			Timpani C#	Guitar Cutting Up	
50	D 2		High Tom	Room Tom 6	Room Tom 6	E Tom 6	Analog Tom 6	Jazz Tom 6	Jazz Tom 6	Timpani D	Ac Bass Slap	
51	D# 2		Ride Cymbal 1							Timpani D#	FL-Key Click	
52	E 2		Chinese Cymbal			Reverse Cymbal				Timpani E	Laughing	
53	F 2		Ride Cymbal Cup							Timpani F	Screaming	
54	F# 2		Tambourine								Punch	
55	G 2		Splash Cymbal								Heartbeat	
56	G# 2		Cowbell				Analog Cowbell				Footsteps 1	
57	A 2		Crash Cymbal 2							Hand Cym.1	Footsteps 2	
58	A# 2		Vibraslap								Applause	
59	B 2		Ride Cymbal 2							Hand Cym.2	Door Creaking	
60	C 3		Bongo H								Door Slam	
61	C# 3		Bongo L								Scratch	
62	D 3		Conga H Mute				Analog Conga H				Windchime	
63	D# 3		Conga H Open				Analog Conga M				Engine Start	
64	E 3		Conga L				Analog Conga L				Tire Screech	
65	F 3		Timbale H								Car Passing	
66	F# 3		Timbale L								Crash	
67	G 3		Agogo H								Siren	
68	G# 3		Agogo L								Train	
69	A 3		Cabasa								Jetplane	
70	A# 3		Maracas				Analog Maracas				Helicopter	
71	B 3	2	Samba Whistle H								Starship	
72	C 4	2	Samba Whistle L								Gunshot	
73	C# 4	3	Guiro Short								Machine Gun	Vibraslap
74	D 4	3	Guiro Long								Laser Gun	
75	D# 4		Claves				Analog Claves				Explosion	
76	E 4		Wood Block H								Dog	Laughing
77	F 4		Wood Block L								Horse Gallop	Screaming
78	F# 4	4	Cuica Mute								Bird Tweet	Punch
79	G 4	4	Cuica Open								Rain	Heartbeat
80	G# 4	5	Triangle Mute								Thunder	Footsteps 1
81	A 4	5	Triangle Open								Wind	Footsteps 2
82	A# 4		Shaker								Seashore	Applause
83	B 4		Jingle Bell								Stream	Door Creaking
84	C 5		Bell Tree								Bubble	Door Slam
85	C# 5		Castanet									Scratch
86	D 5	6	Surdo Mute									Windchime
87	D# 5	6	Surdo Open									Engine Start
88	E 5									Applause		Tire Screech
89	F 5											Car Passing
90	F# 5											Crash
91	G 5											Siren
92	G# 5											Train
93	A 5											Jetplane
94	A# 5											Helicopter
95	B 5											Starship
96	C 6											Gunshot
97	C# 6											Machine Gun
98	D 6											Laser Gun
99	D# 6											Explosion
100	E 6											Dog
101	F 6											Horse Gallop
102	F# 6											Bird Tweet
103	G 6											Rain
104	G# 6											Thunder
105	A 6											Wind
106	A# 6											Seashore
107	B 6											Stream
108	C 7											Bubble

: Same as Standard kit
 : No sound

Effect Type List

Exclusive		Effect Type	Description
MSB	LSB		
REVERB			
00	00	NO EFFECT	Effect turned off.
01	00	HALL1	Reverb simulating the resonance of a hall.
01	01	HALL2	Reverb simulating the resonance of a hall.
02	00	ROOM1	Reverb simulating the resonance of a room.
02	01	ROOM2	Reverb simulating the resonance of a room.
02	02	ROOM3	Reverb simulating the resonance of a room.
03	00	STAGE1	Reverb appropriate for a solo instrument.
03	01	STAGE2	Reverb appropriate for a solo instrument.
04	00	PLATE	Reverb simulating a metal plate reverb unit.
10	00	WHITE ROOM	A unique short reverb with a bit of initial delay.
11	00	TUNNEL	Simulation of a tunnel space expanding to left and right.
13	00	BASEMENT	A bit of initial delay followed by reverb with a unique resonance.
CHORUS			
00	00	NO EFFECT	Effect turned off.
41	00	CHORUS1	Conventional chorus program that adds natural spaciousness.
41	01	CHORUS2	Conventional chorus program that adds natural spaciousness.
41	02	CHORUS3	Conventional chorus program that adds natural spaciousness.
41	08	CHORUS4	Chorus with stereo input. The pan setting specified for the Part will also apply to the effect sound.
42	00	CELESTE1	A 3-phase LFO adds modulation and spaciousness to the sound.
42	01	CELESTE2	A 3-phase LFO adds modulation and spaciousness to the sound.
42	02	CELESTE3	A 3-phase LFO adds modulation and spaciousness to the sound.
42	08	CELESTE4	Celeste with stereo input. The pan setting specified for the Part will also apply to the effect sound.
43	00	FLANGER1	Adds a jet-airplane effect to the sound.
43	01	FLANGER2	Adds a jet-airplane effect to the sound.
43	08	FLANGER3	Adds a jet-airplane effect to the sound.
VARIATION			
00	00	NO EFFECT	Effect turned off.
01	00	HALL1	Reverb simulating the resonance of a hall.
01	01	HALL2	Reverb simulating the resonance of a hall.
02	00	ROOM1	Reverb simulating the resonance of a room.
02	01	ROOM2	Reverb simulating the resonance of a room.
02	02	ROOM3	Reverb simulating the resonance of a room.
03	00	STAGE1	Reverb appropriate for a solo instrument.
03	01	STAGE2	Reverb appropriate for a solo instrument.
04	00	PLATE	Reverb simulating a metal plate reverb unit.
05	00	DELAY L, C, R	A program that creates three delay sounds; L, R, and C (center).
06	00	DELAY L, R	A program that creates two delay sounds; L and R. Two feedback delays are provided.
07	00	ECHO	Two delays (L and R) and independent feedback delays for L and R.
08	00	CROSS DELAY	A program that crosses the feedback of two delays.
09	00	EARLY REF1	An effect that produces only the early reflection component of reverb.
09	01	EARLY REF2	An effect that produces only the early reflection component of reverb.
0A	00	GATE REVERB	A simulation of gated reverb.
0B	00	REVERSE GATE	A program that simulates gated reverb played backwards.
14	00	KARAOKE 1	A delay with feedback of the same types as used for karaoke reverb.
14	01	KARAOKE 2	A delay with feedback of the same types as used for karaoke reverb.
14	02	KARAOKE 3	A delay with feedback of the same types as used for karaoke reverb.
41	00	CHORUS1	Conventional chorus program that add natural spaciousness.
41	01	CHORUS2	Conventional chorus program that adds natural spaciousness.
41	02	CHORUS3	Conventional chorus program that adds natural spaciousness.
41	08	CHORUS4	Chorus with stereo input.
42	00	CELESTE1	A 3-phase LFO adds modulation and spaciousness to the sound.
42	01	CELESTE2	A 3-phase LFO adds modulation and spaciousness to the sound.
42	02	CELESTE3	A 3-phase LFO adds modulation and spaciousness to the sound.
42	08	CELESTE4	Celeste with stereo input.
43	00	FLANGER1	Adds a jet-airplane effect to the sound.
43	01	FLANGER2	Adds a jet-airplane effect to the sound.
43	08	FLANGER3	Adds a jet-airplane effect to the sound.
44	00	SYMPHONIC	A multi-phase version of CELESTE.
45	00	ROTARY SPEAKER	A simulation of a rotary speaker. You can use AC1 (assignable controller) etc. to control the speed of rotation.
46	00	TREMOLO	An effect that cyclically modulates the volume.
47	00	AUTO PAN	A program that cyclically moves that sound image to left and right, front and back.
48	00	PHASER1	Cyclically changes the phase to add modulation to the sound.
48	08	PHASER2	Phaser with stereo input.
49	00	DISTORTION	Adds a sharp-edged distortion to the sound.
4A	00	OVER DRIVE	Adds mild distortion to the sound.
4B	00	AMP SIMULATOR	A simulation of a guitar amp.
4C	00	3BAND EQ (MONO)	A mono EQ with adjustable LOW, MID, and HIGH equalizing.
4D	00	2BAND EQ (STEREO)	A stereo EQ with adjustable LOW and HIGH. Ideal for drum Parts.
4E	00	AUTO WAH (LFO)	Cyclically modulates the center frequency of a wah filter. With an AC1 etc. this can function as a pedal wah.
40	00	THRU	Bypass without applying any effect.

* MSB, LSB is represented in hexadecimal.

* LCB=0 is the basic effect type.

Effect Parameter List

No	Parameter	Range	Value	See Table	Control
HALL1, HALL2, ROOM 1, 2, 3, STAGE 1, 2, PLATE					
1	Reverb Time	0.3~30.0s	0-69	table#4	
2	Diffusion	0~10	0-10		
3	Initial Delay	0~63	0-63	table#5	
4	HPF Cutoff	Thru~8.0kHz	0-52	table#3	
5	LPF Cutoff	1.0k~Thru	34-60	table#3	
6					
7					
8					
9					
10	Dry/Wet	D63>W~D=W~D<W63	1-127		•
11	Rev Delay	0~63	0-63	table#5	
12	Density	0~3	0-3		
13	Er/Rev Balance	E63>R ~ E=R ~ E>R63	1-127		
14					
15	Feedback Level	-63~+63	1-127		
16					
WHITE ROOM, TUNNEL, BASEMENT					
1	Reverb Time	0.3~30.0s	0-69	table#4	
2	Diffusion	0~10	0-10		
3	Initial Delay	0~63	0-63	table#5	
4	HPF Cutoff	Thru~8.0kHz	0-52	table#3	
5	LPF Cutoff	1.0k~Thru	34-60	table#3	
6	Width	0.5~10.2m	0-37	table#11	
7	Height	0.5~20.2m	0-73	table#11	
8	Depth	0.5~30.2m	0-104	table#11	
9	Wall Vary	0~30	0-30		
10	Dry/Wet	D63>W~D=W~D<W63	1-127		•
11	Rev Delay	0~63	0-63	table#5	
12	Density	0~3	0-3		
13	Er/Rev Balance	E63>R~E=R~E>R63	1-127		
14					
15	Feedback Level	-63~+63	1-127		
16					
DELAY L, C, R					
1	Lch Delay	0.1~715.0ms	1-7150		
2	Rch Delay	0.1~715.0ms	1-7150		
3	Cch Delay	0.1~715.0ms	1-7150		
4	Feedback Delay	0.1~715.0ms	1-7150		
5	Feedback Level	-63~+63	1-127		
6	Cch Level	0~127	0-127		
7	High Damp	0.1~1.0	1-10		
8					
9					
10	Dry/Wet	D63>W~D=W~D<W63	1-127		•
11					
12					
13	EQ Low Frequency	50Hz~2.0kHz	8-40	table#3	
14	EQ Low Gain	-12~+12dB	52-76		
15	EQ High Frequency	500Hz~16.0kHz	28-58	table#3	
16	EQ High Gain	-12~+12dB	52-76		
DELAY L, R					
1	Lch Delay	0.1~715.0ms	1-7150		
2	Rch Delay	0.1~715.0ms	1-7150		
3	Feedback Delay1	0.1~715.0ms	1-7150		
4	Feedback Delay2	0.1~715.0ms	1-7150		
5	Feedback Level	-63~+63	1-127		
6	High Damp	0.1~1.0	1-10		
7					
8					
9					
10	Dry/Wet	D63>W~D=W~D<W63	1-127		•
11					
12					
13	EQ Low Frequency	50Hz~2.0kHz	8-40	table#3	
14	EQ Low Gain	-12~+12dB	52-76		
15	EQ High Frequency	500Hz~16.0kHz	28-58	table#3	
16	EQ High Gain	-12~+12dB	52-76		

No	Parameter	Range	Value	See Table	Control
ECHO					
1	Lch Delay1	0.1~355.0ms	1-3350		
2	Lch Feedback Level	-63~+63	1-127		
3	Rch Delay1	0.1~355.0ms	1-3550		
4	Rch Feedback Level	-63~+63	1-127		
5	High Damp	0.1~1.0	1-10		
6	Lch Delay2	0.1~355.0ms	1-3550		
7	Rch Delay2	0.1~355.0ms	1-3550		
8	Delay2 Level	0~127	0-127		
9					
10	Dry/Wet	D63>W~D=W~D<W63	1-127		•
11					
12					
13	EQ Low Frequency	50Hz~2.0kHz	8-40	table#3	
14	EQ Low Gain	-12~+12dB	52-76		
15	EQ High Frequency	500Hz~16.0kHz	28-58	table#3	
16	EQ High Gain	-12~+12dB	52-76		
CROSS DELAY					
1	L->R Delay	0.1~355.0ms	1-3550		
2	R->L Delay	0.1~355.0ms	1-3550		
3	Feedback Level	-63~+63	1-127		
4	Input Select	L, R, L&R	0-2		
5	High Damp	0.1~1.0	1-10		
6					
7					
8					
9					
10	Dry/Wet	D63>W~D=W~D<W63	1-127		•
11					
12					
13	EQ Low Frequency	50Hz~2.0kHz	8-40	table#3	
14	EQ Low Gain	-12~+12dB	52-76		
15	EQ High Frequency	500Hz~16.0kHz	28-58	table#3	
16	EQ High Gain	-12~+12dB	52-76		
EARLY REF1, EARLY REF2					
1	Type	S-H, L-H, Rdm, Rvs, Plt, Spr	0-5		
2	Room Size	0.1~7.0	0-44	table#6	
3	Diffusion	0~10	0-10		
4	Initial Delay	0~63	0-63	table#5	
5	Feedback Level	-63~+63	1-127		
6	HPF Cutoff	Thru~8.0kHz	0-52		
7	LPF Cutoff	1.0k~Thru	34-60		
8					
9					
10	Dry/Wet	D63>W~D=W~D<W63	1-127		•
11	Liveness	0~10	0-10		
12	Density	0~3	0-3		
13	High Damp	0.1~1.0	1-10		
14					
15					
16					
GATE REVERB, REVERSE GATE					
1	Type	TypeA, TypeB	0-1		
2	Room Size	0.1~7.0	0-44	table#6	
3	Diffusion	0~10	0-10		
4	Initial Delay	0~63	0-63	table#5	
5	Feedback Level	-63~+63	1-127		
6	HPF Cutoff	Thru~8.0kHz	0-52		
7	LPF Cutoff	1.0k~Thru	34-60		
8					
9					
10	Dry/Wet	D63>W~D=W~D<W63	1-127		•
11	Liveness	0~10	0-10		
12	Density	0~3	0-3		
13	High Damp	0.1~1.0	1-10		
14					
15					
16					

• : Can be controlled by AC1 (Assignable Controller 1)
 No.* : These numbers correspond to the Parameter Suffix numbers in <Table 1-3>
 See Table** : Refer to "Effect Data Assign Table"

No	Parameter	Range	Value	See Table	Control
KARAOKE 1, 2, 3					
1	Delay Time	0~127	0-127	table#7	
2	Feedback Level	-63~+63	1-127		
3	HPF Cutoff	Thru~8.0kHz	0-52		
4	LPF Cutoff	1.0k~Thru	34-60		
5					
6					
7					
8					
9					
10	Dry/Wet	D63>W~D=W~D<W63	1-127		•
11					
12					
13					
14					
15					
16					
CHORUS 1, 2, 3, 4, CELESTE 1, 2, 3, 4					
1	LFO Frequency	0.00~39.7Hz	0-127	table#1	
2	LFO PM Depth	0~127	0-127		
3	Feedback Level	-63~+63	1-127		
4	Delay Offset	0~127	0-127	table#2	
5					
6	EQ Low Frequency	50Hz~2.0kHz	8-40	table#3	
7	EQ Low Gain	-12~+12dB	52-76		
8	EQ High Frequency	500Hz~16.0kHz	28-58	table#3	
9	EQ High Gain	-12~+12dB	52-76		
10	Dry/Wet	D63>W~D=W~D<W63	1-127		•
11					
12					
13					
14					
15	Input Mode	mono/stereo	0-1		
16					
FLANGER 1, 2, 3					
1	LFO Frequency	0.00~39.7Hz	0-127	table#1	
2	LFO Depth	0~127	0-127		
3	Feedback Level	-63~+63	1-127		
4	Delay Offset	0~63	0-63	table#2	
5					
6	EQ Low Frequency	50Hz~2.0kHz	8-40	table#3	
7	EQ Low Gain	-12~+12dB	52-76		
8	EQ High Frequency	500Hz~16.0kHz	28-58	table#3	
9	EQ High Gain	-12~+12dB	52-76		
10	Dry/Wet	D63>W~D=W~D<W63	1-127		•
11					
12					
13					
14	LFO Phase Difference	-180~+180deg	4-124		
15					
16					
SYMPHONIC					
1	LFO Frequency	0.00~39.7Hz	0-127	table#1	
2	LFO Depth	0~127	0-127		
3	Delay Offset	0~127	0-127	table#2	
4					
5					
6	EQ Low Frequency	50Hz~2.0kHz	8-40	table#3	
7	EQ Low Gain	-12~+12dB	52-76		
8	EQ High Frequency	500Hz~16.0kHz	28-58	table#3	
9	EQ High Gain	-12~+12dB	52-76		
10	Dry/Wet	D63>W~D=W~D<W63	1-127		•
11					
12					
13					
14					
15					
16					

No	Parameter	Range	Value	See Table	Control
ROTARY SPEAKER					
1	LFO Frequency	0.00~39.7Hz	0-127	table#1	•
2	LFO Depth	0~127	0-127		
3					
4					
5					
6	EQ Low Frequency	50Hz~2.0kHz	8-40	table#3	
7	EQ Low Gain	-12~+12dB	52-76		
8	EQ High Frequency	500Hz~16.0kHz	28-58	table#3	
9	EQ High Gain	-12~+12dB	52-76		
10	Dry/Wet	D63>W~D=W~D<W63	1-127		
11					
12					
13					
14					
15					
16					
TREMOLO					
1	LFO Frequency	0.00~39.7Hz	0-127	table#1	•
2	AM Depth	0~127	0-127		
3	PM Depth	0~127	0-127		
4					
5					
6	EQ Low Frequency	50Hz~2.0kHz	8-40	table#3	
7	EQ Low Gain	-12~+12dB	52-76		
8	EQ High Frequency	500Hz~16.0kHz	28-58	table#3	
9	EQ High Gain	-12~+12dB	52-76		
10					
11					
12					
13					
14		-180~+180deg	4-124		
15	Input Mode	mono/stereo	0-1		
16					
AUTO PAN					
1	LFO Frequency	0.00~39.7Hz	0-127	table#1	•
2	L/R Depth	0~127	0-127		
3	F/R Depth	0~127	0-127		
4	PAN Direction	L<->R, L->R, L<-R, Lturn, Rturn, L/R	0-5		
5					
6	EQ Low Frequency	50Hz~2.0kHz	8-40	table#3	
7	EQ Low Gain	-12~+12dB	52-76		
8	EQ High Frequency	500Hz~16.0kHz	28-58	table#3	
9	EQ High Gain	-12~+12dB	52-76		
10					
11					
12					
13					
14					
15					
16					
PHASER1, PHASER2					
1	LFO Frequency	0.00~39.7Hz	0-127	table#1	
2	LFO Depth	0~127	0-127		
3	Phase Shift	0~127	0-127		
4	Feedback Level	-63~+63	1-127		
5					
6	EQ Low Frequency	50Hz~2.0kHz	8-40	table#3	
7	EQ Low Gain	-12~+12dB	52-76		
8	EQ High Frequency	500Hz~16.0kHz	28-58	table#3	
9	EQ High Gain	-12~+12dB	52-76		
10	Dry/Wet	D63>W~D=W~D<W63	1-127		•
11	Stage	3~10	3-10		
12	Diffusion	Mono/Stereo	0-1		
13	LFO Phase Di	-180~+180deg	4-124		
14					
15					
16					

• : Can be controlled by AC1 (Assignable Controller 1)
 No.* : These numbers correspond to the Parameter Suffix numbers in <Table 1-3>
 See Table** : Refer to "Effect Data Assign Table"

MIDI Data Format

No	Parameter	Range	Value	See Table	Control
DISTORTION, OVERDRIVE					
1	Drive	0~127	0-127		•
2	EQ Low Frequency	50Hz~2.0kHz	8-40	table#3	
3	EQ Low Gain	-12~+12dB	52-76		
4	LPF Cutoff	1.0k~Thru	34-60	table#3	
5	Output Level	0~127	0-127		
6					
7	EQ Mid Frequency	500Hz~10.0kHz	28-54	table#3	
8	EQ Mid Gain	-12~+12dB	52-76		
9	EQ Mid Width	1.0~12.0	10-120		
10	Dry/Wet	D63>W~D=W~D<W63	1-127		
11	Edge (Clip Curve)	0~127	0-127	mild -sharp	
12					
13					
14					
15					
16					
GUITAR AMP SIMULATOR					
1	Drive	0~127	0-127		•
2	AMP Type	Off, Stack, Combo, Tube	0-3		
3	LPF Cutoff	1.0k~Thru	34-60	table#3	
4	Output Level	0~127	0-127		
5					
6					
7					
8					
9					
10	Dry/Wet	D63>W~D=W~D<W63	1-127		
11	Edge (Clip Curve)	0~127	0-127	mild -sharp	
12					
13					
14					
15					
16					
3-BAND EQ					
1	EQ Low Gain	-12~+12dB	52-76		
2	EQ Mid Frequency	500Hz~10.0kHz	28-54	table#3	
3	EQ Mid Gain	-12~+12dB	52-76		
4	EQ Mid Width	1.0~12.0	10-120		
5	EQ High Gain	-12~+12dB	52-76		
6	EQ Low Frequency	50Hz~2.0kHz	8-40	table#3	
7	EQ High Frequency	500Hz~16.0kHz	28-58	table#3	
8					
9					
10					
11					
12					
13					
14					
15					
16					

No	Parameter	Range	Value	See Table	Control
2-BAND EQ					
1	EQ Low Frequency	50Hz~2.0kHz	8-40	table#3	
2	EQ Low Gain	-12~+12dB	52-76		
3	EQ High Frequency	500Hz~16.0kHz	28-58	table#3	
4	EQ High Gain	-12~+12dB	52-76		
5					
6					
7					
8					
9					
10					
11	EQ Mid Frequency	100Hz~10.0kHz	14-54	table#3	
12	EQ Mid Gain	-12~+12dB	52-76		
13	EQ Mid Width	1.0~12.0	10-120		
14					
15					
16					
AUTO WAH					
1	LFO Frequency	0.00~39.7Hz	0-127	table#1	
2	LFO Depth	0~127	0-127		
3	Cutoff Frequency	0~127	0-127		•
4	Resonance	1.0~12.0	10-120		
5					
6	EQ Low Frequency	50Hz~2.0kHz	8-40	table#3	
7	EQ Low Gain	-12~+12dB	52-76		
8	EQ High Frequency	500Hz~16.0kHz	28-58	table#3	
9	EQ High Gain	-12~+12dB	52-76		
10	Dry/Wet	D63>W~D=W~D<W63	1-127		
11					
12					
13					
14					
15					
16					

- : Can be controlled by AC1 (Assignable Controller 1)
- No.* : These numbers correspond to the Parameter Suffix numbers in <Table 1-3>
- See Table** : Refer to "Effect Data Assign Table"

Effect Data Assign Table

Table#1

LFO Frequency (Hz)

Data	Value	Data	Value	Data	Value
0	0.00	43	1.81	86	5.38
1	0.04	44	1.85	87	5.55
2	0.08	45	1.89	88	5.72
3	0.13	46	1.94	89	6.06
4	0.17	47	1.98	90	6.39
5	0.21	48	2.02	91	6.73
6	0.25	49	2.06	92	7.07
7	0.29	50	2.10	93	7.40
8	0.34	51	2.15	94	7.74
9	0.38	52	2.19	95	8.08
10	0.42	53	2.23	96	8.41
11	0.46	54	2.27	97	8.75
12	0.51	55	2.31	98	9.08
13	0.55	56	2.36	99	9.42
14	0.59	57	2.40	100	9.76
15	0.63	58	2.44	101	10.10
16	0.67	59	2.48	102	10.80
17	0.72	60	2.52	103	11.40
18	0.76	61	2.57	104	12.10
19	0.80	62	2.61	105	12.80
20	0.84	63	2.65	106	13.50
21	0.88	64	2.69	107	14.10
22	0.93	65	2.78	108	14.80
23	0.97	66	2.86	109	15.50
24	1.01	67	2.94	110	16.20
25	1.05	68	3.03	111	16.80
26	1.09	69	3.11	112	17.50
27	1.14	70	3.20	113	18.20
28	1.18	71	3.28	114	19.50
29	1.22	72	3.37	115	20.90
30	1.26	73	3.45	116	22.20
31	1.30	74	3.53	117	23.60
32	1.35	75	3.62	118	24.90
33	1.39	76	3.70	119	26.20
34	1.43	77	3.87	120	27.60
35	1.47	78	4.04	121	28.90
36	1.51	79	4.21	122	30.30
37	1.56	80	4.37	123	31.60
38	1.60	81	4.54	124	33.00
39	1.64	82	4.71	125	34.30
40	1.68	83	4.88	126	37.00
41	1.72	84	5.05	127	39.70
42	1.77	85	5.22		

Table#2

Modulation Delay Offset (ms)

Data	Value	Data	Value	Data	Value
0	0.0	43	4.3	86	8.6
1	0.1	44	4.4	87	8.7
2	0.2	45	4.5	88	8.8
3	0.3	46	4.6	89	8.9
4	0.4	47	4.7	90	9.0
5	0.5	48	4.8	91	9.1
6	0.6	49	4.9	92	9.2
7	0.7	50	5.0	93	9.3
8	0.8	51	5.1	94	9.4
9	0.9	52	5.2	95	9.5
10	1.0	53	5.3	96	9.6
11	1.1	54	5.4	97	9.7
12	1.2	55	5.5	98	9.8
13	1.3	56	5.6	99	9.9
14	1.4	57	5.7	100	10.0
15	1.5	58	5.8	101	11.1
16	1.6	59	5.9	102	12.2
17	1.7	60	6.0	103	13.3
18	1.8	61	6.1	104	14.4
19	1.9	62	6.2	105	15.5
20	2.0	63	6.3	106	17.1
21	2.1	64	6.4	107	18.6
22	2.2	65	6.5	108	20.2
23	2.3	66	6.6	109	21.8
24	2.4	67	6.7	110	23.3
25	2.5	68	6.8	111	24.9
26	2.6	69	6.9	112	26.5
27	2.7	70	7.0	113	28.0
28	2.8	71	7.1	114	29.6
29	2.9	72	7.2	115	31.2
30	3.0	73	7.3	116	32.8
31	3.1	74	7.4	117	34.3
32	3.2	75	7.5	118	35.9
33	3.3	76	7.6	119	37.5
34	3.4	77	7.7	120	39.0
35	3.5	78	7.8	121	40.6
36	3.6	79	7.9	122	42.2
37	3.7	80	8.0	123	43.7
38	3.8	81	8.1	124	45.3
39	3.9	82	8.2	125	46.9
40	4.0	83	8.3	126	48.4
41	4.1	84	8.4	127	50.0
42	4.2	85	8.5		

Table#3

EQ Frequency (Hz)

Data	Value	Data	Value
0	THRU(20)	43	2.8k
1	22	44	3.2k
2	25	45	3.6k
3	28	46	4.0k
4	32	47	4.5k
5	36	48	5.0k
6	40	49	5.6k
7	45	50	6.3k
8	50	51	7.0k
9	56	52	8.0k
10	63	53	9.0k
11	70	54	10.0k
12	80	55	11.0k
13	90	56	12.0k
14	100	57	14.0k
15	110	58	16.0k
16	125	59	18.0k
17	140	60	THRU(20.0k)
18	160		
19	180		
20	200		
21	225		
22	250		
23	280		
24	315		
25	355		
26	400		
27	450		
28	500		
29	560		
30	630		
31	700		
32	800		
33	900		
34	1.0k		
35	1.1k		
36	1.2k		
37	1.4k		
38	1.6k		
39	1.8k		
40	2.0k		
41	2.2k		
42	2.5k		

Table#4

Reverb Time (ms)

Data	Value	Data	Value
0	0.3	43	4.6
1	0.4	44	4.7
2	0.5	45	4.8
3	0.6	46	4.9
4	0.7	47	5.0
5	0.8	48	5.5
6	0.9	49	6.0
7	1.0	50	6.5
8	1.1	51	7.0
9	1.2	52	7.5
10	1.3	53	8.0
11	1.4	54	8.5
12	1.5	55	9.0
13	1.6	56	9.5
14	1.7	57	10.0
15	1.8	58	11.0
16	1.9	59	12.0
17	2.0	60	13.0
18	2.1	61	14.0
19	2.2	62	15.0
20	2.3	63	16.0
21	2.4	64	17.0
22	2.5	65	18.0
23	2.6	66	19.0
24	2.7	67	20.0
25	2.8	68	25.0
26	2.9	69	30.0
27	3.0		
28	3.1		
29	3.2		
30	3.3		
31	3.4		
32	3.5		
33	3.6		
34	3.7		
35	3.8		
36	3.9		
37	4.0		
38	4.1		
39	4.2		
40	4.3		
41	4.4		
42	4.5		

Table#5

Delay Time (ms)

Data	Value	Data	Value	Data	Value
0	0.1	43	67.8	86	135.5
1	1.7	44	69.4	87	137.0
2	3.2	45	70.9	88	138.6
3	4.8	46	72.5	89	140.2
4	6.4	47	74.1	90	141.8
5	8.0	48	75.7	91	143.3
6	9.5	49	77.2	92	144.9
7	11.1	50	78.8	93	146.5
8	12.7	51	80.4	94	148.1
9	14.3	52	81.9	95	149.6
10	15.8	53	83.5	96	151.2
11	17.4	54	85.1	97	152.8
12	19.0	55	86.7	98	154.4
13	20.6	56	88.2	99	155.9
14	22.1	57	89.8	100	157.5
15	23.7	58	91.4	101	159.1
16	25.3	59	93.0	102	160.6
17	26.9	60	94.5	103	162.2
18	28.4	61	96.1	104	163.8
19	30.0	62	97.7	105	165.4
20	31.6	63	99.3	106	166.9
21	33.2	64	100.8	107	168.5
22	34.7	65	102.4	108	170.1
23	36.3	66	104.0	109	171.7
24	37.9	67	105.6	110	173.2
25	39.5	68	107.1	111	174.8
26	41.0	69	108.7	112	176.4
27	42.6	70	110.3	113	178.0
28	44.2	71	111.9	114	179.5
29	45.7	72	113.4	115	181.1
30	47.3	73	115.0	116	182.7
31	48.9	74	116.6	117	184.3
32	50.5	75	118.2	118	185.8
33	52.0	76	119.7	119	187.4
34	53.6	77	121.3	120	189.0
35	55.2	78	122.9	121	190.6
36	56.8	79	124.4	122	192.1
37	58.3	80	126.0	123	193.7
38	59.9	81	127.6	124	195.3
39	61.5	82	129.2	125	196.9
40	63.1	83	130.7	126	198.4
41	64.6	84	132.3	127	200.0
42	66.2	85	133.9		

Table#6

Room Size (m)

Data	Value	Data	Value
0	0.1	43	6.8
1	0.3	44	7.0
2	0.4		
3	0.6		
4	0.7		
5	0.9		
6	1.0		
7	1.2		
8	1.4		
9	1.5		
10	1.7		
11	1.8		
12	2.0		
13	2.1		
14	2.3		
15	2.5		
16	2.6		
17	2.8		
18	2.9		
19	3.1		
20	3.2		
21	3.4		
22	3.5		
23	3.7		
24	3.9		
25	4.0		
26	4.2		
27	4.3		
28	4.5		
29	4.6		
30	4.8		
31	5.0		
32	5.1		
33	5.3		
34	5.4		
35	5.6		
36	5.7		
37	5.9		
38	6.1		
39	6.2		
40	6.4		
41	6.5		
42	6.7		

Table#7

Delay Time (ms)

Data	Value	Data	Value	Data	Value
0	0.1	43	135.5	86	270.9
1	3.2	44	138.6	87	274.0
2	6.4	45	141.8	88	277.2
3	9.5	46	144.9	89	280.3
4	12.7	47	148.1	90	283.5
5	15.8	48	151.2	91	286.6
6	19.0	49	154.4	92	289.8
7	22.1	50	157.5	93	292.9
8	25.3	51	160.7		

MIDI IMPLEMENTATION CHART

Function...		Transmitted	Recognized	Remarks
Basic	Default	1-16	1-16	Memorized
Channel	Changed	1-16	1-16	
Mode	Default	3	3	
	Messages	x	3, 4 (m=1) *2, *3	
	Altered	*****	x	
Note		0-127	0-127	
Number	: True voice	*****	0-127	
Velocity	Note ON	o 9nH, v=1-127	o v=1-127	
	Note OFF	o 8nH, v=0-127	o	
After	Key s	o *5	o	
Touch	Ch s	x	o *1, *2	
Pitch Bend		x	o 0-24 semi *1, *2	
Control	0, 32	o	o *1, *2	Bank Select
	7, 11	o	o *1	
	1, 5, 10	x	o *1, *2	
	6, 38	x	o *2	Data Entry
	64	o	o	Hold1 (Sustain)
	65	x	o *2	Portament
	66	o *4	o *2	Sostenuto
	67	o	o	Soft (Shift) Pedal
	71-74, 84	x	o *2	
	91, 93, 94	x	o *2	Effect Depth
96-101	x	o *1, *2		
Prog		o 0-127	o 0-127 *2	
Change	: True #	*****		
System Exclusive		o	o	
Common	: Song Pos	x	x	
	: Song Sel	x	x	
	: Tune	x	x	
System	: Clock	x	x	
Real Time	: Commands	x	x	
Aux	: All Sound OFF	o	o (120, 126, 127)	
	: Reset All Cntrls	x	o (121)	
	: Local ON/OFF	x	o	
	: All Notes OFF	o	o (123-125)	
	Messages : Active Sense	o	o	
	: Reset	x	x	
Notes	*1 = Received (transmitted) if switch is on. *2 = Only ESBL Part can recognized. *3 = m is always treated as 1 regardless of its value. *4 = Transmit if this model has a Sostenuto Pedal.		*5 = Applying further pressure on the key does not output key aftertouch information. Instead, key position is transmitted as additional information.	

Mode 1 : OMNI ON. POLY Mode 2 : OMNI ON. MONO o : YES
 Mode 3 : OMNI OFF. POLY Mode 4 : OMNI OFF. MONO x : NO



YAMAHA CORPORATION
P. O. Box 1, Hamamatsu, 430-8650 Japan