

YAMAHA

RX-496RDS/496

RX-396RDS/396

Natural Sound Stereo Receiver

Récepteur stéréo

Natural Sound Stereoreceiver

Natural Sound Stereoreceiver

Ricevitore stereo a suono naturale

Receptor estéreo de Sonido Natural

Natural Sound Stereo Ontvanger

OWNER'S MANUAL
MODE D'EMPLOI
BEDIENUNGSANLEITUNG
BRUKSANVISNING
MANUALE DI ISTRUZIONI
MANUAL DE INSTRUCCIONES
GEBRUIKSAANWIJZING

SUPPLIED ACCESSORIES
ACCESSOIRES FOURNIS
MITGELIEFERTE ZUBEHÖRTEILE
MEDFÖLJANDE TILLBEHÖR
ACCESSORI IN DOTAZIONE
ACCESORIOS INCLUIDOS
BIJGELEVERDE ACCESSOIRES

- After unpacking, check that the following parts are included.
- Après le déballage, vérifier que les pièces suivantes sont incluses.
- Nach dem Auspacken überprüfen, ob die folgenden Teile vorhanden sind.
- Kontrollera efter det apparaten packats upp att följande delar finns med.
- Verificare che tutte le parti seguenti siano contenute nell'imbballaggio dell'apparecchio.
- Desembalar el aparato y verificar que los siguientes accesorios están en la caja.
- Controleer na het uitpakken of de volgende onderdelen voorhanden zijn.

- Indoor FM Antenna
- Antenne FM intérieure
- UKW-Innenantenne
- FM inomhusantenn
- Antenna FM interna
- Antena FM interior
- FM Binnenantenne

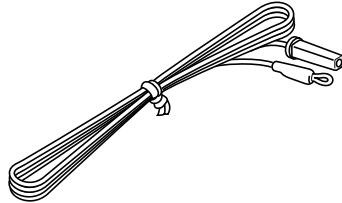

- Remote Control Transmitter
- Télécommande
- Fernbedienung
- Fjärrkontroll
- Telecomando
- Transmisor de control remoto
- Afstandbediening

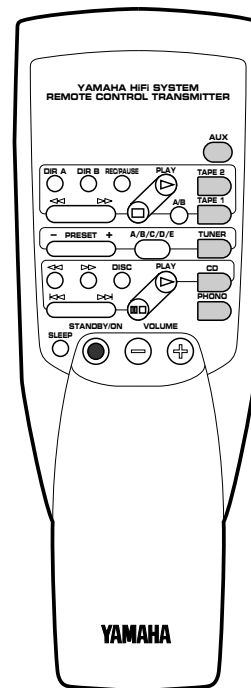

- AM Loop Antenna
- Cadre-antenne AM
- MW-Rahmenantenne
- AM ramantenn
- Antenna AM ad anello
- Antena de cuadro de AM
- AM Lusantenne

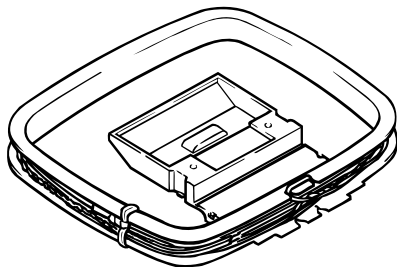

- 75-ohm/300-ohm antenna adapter (U.K. model only)
- Adaptateur d'antenne 75 ohms/300 ohms (Modèle pour le Royaume-Uni seulement)
- 75 Ohm/300 Ohm Antennenstecker (Nur Großbritannien-Modell)
- 75 ohm/300 ohm antennadapter (Endast modell för Storbritannien)
- Adattatore per antenna da 75 e 300 ohm (Solo modello per la Gran Bretagna)
- Adaptador de antena de 75 ohmios/300 ohmios (Sólo modelo para Reino Unido)
- 75 ohm/300 ohm antenne-adapter (Alleen modellen voor Groot-Brittannië)

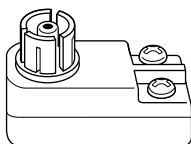

- Batteries (size AA, R6, UM-3)
- Piles (taille AA, R6, UM-3)
- Batterien (Größe AA, R6, UM-3)
- Batterier (storlek AA, R6, UM-3)
- Batterie (dimensioni AA, R6, UM-3)
- Pilas (tamaño AA, R6, UM-3)
- Batterijen (maat AA, R6, UM-3)

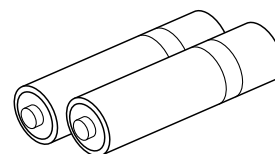

FEATURES

- **Minimum RMS Output Power per Channel**
 - RX-496RDS and RX-496**
75W + 75W (8Ω) RMS Output Power, 0.04% THD, 20–20,000 Hz
 - RX-396RDS and RX-396**
50W + 50W (8Ω) RMS Output Power, 0.04% THD, 20–20,000 Hz
- **High Dynamic Power, Low Impedance Drive Capability**
- **Continuously Variable LOUDNESS Control**
- **40-Station Random Access Preset Tuning**
- **Automatic Preset Tuning**
- **Preset Station Shifting Capability (Preset Editing)**
- **IF Count Direct PLL Synthesizer Tuning System**
- **SLEEP Timer**
- **Remote Control Capability**
- **RX-496RDS and RX-396RDS only**
Multi-Functions for RDS Broadcast Reception
- **RX-496RDS and RX-496 only**
PURE DIRECT Switch to Reproduce the Purest Source Sound

CONTENTS

| | | | |
|--|----|---|----|
| SUPPLIED ACCESSORIES | 2 | BASIC OPERATIONS | 14 |
| FEATURES | 3 | TUNING OPERATIONS | 17 |
| CAUTION | 4 | PRESET TUNING | 18 |
| NOTES ABOUT THE REMOTE CONTROL TRANSMITTER | 5 | RECEIVING RDS STATIONS | |
| CONNECTIONS | 6 | RX-496RDS and RX-396RDS only | 21 |
| CONTROLS AND THEIR FUNCTIONS | 10 | TROUBLESHOOTING | 26 |
| | | SPECIFICATIONS | 27 |

CAUTION : READ THIS BEFORE OPERATING YOUR UNIT.

1. To assure the finest performance, please read this manual carefully. Keep it in a safe place for future reference.
2. Install this unit in a cool, dry, clean place – away from windows, heat sources, sources of excessive vibration, dust, moisture and cold. Avoid sources of humming (transformers, motors). To prevent fire or electrical shock, do not expose the unit to rain or water.
3. Never open the cabinet. If something drops into the set, contact your dealer.
4. Do not use force on switches, controls or connection wires. When moving the unit, first disconnect the power plug and the wires connected to other equipment. Never pull the wires themselves.
5. The openings on the cabinet assure proper ventilation of the unit. If these openings are obstructed, the temperature inside the cabinet will rise rapidly. Therefore, avoid placing objects against these openings, and install the unit in well-ventilated condition. Be sure to allow a space of at least 20 cm behind, 20 cm on the both sides and 30 cm above the top panel of the unit. Otherwise it may not only damage the unit, but also cause fire.
6. Always set the VOLUME control to “– ∞” before starting the audio source play. Increase the volume gradually to an appropriate level after playback has been started.
7. Do not attempt to clean the unit with chemical solvents; this might damage the finish. Use a clean, dry cloth.
8. Be sure to read the “TROUBLESHOOTING” section regarding common operating errors before concluding that the unit is faulty.
9. When not planning to use this unit for long periods of time (ie., vacation, etc.), disconnect the AC power plug from the wall outlet.
10. To prevent lightning damage, disconnect the AC power plug and antenna cable when there is an electrical storm.
11. Grounding or polarization – Precautions should be taken so that the grounding or polarization of an appliance is not defeated.
12. Do not connect audio equipment to the AC outlet on the rear panel if the equipment requires more power than the outlet is rated to provide.
13. **Voltage Selector (General Model only)**
The voltage selector on the rear panel of this unit must be set for your local main voltage BEFORE plugging into the AC main supply.
Voltages are 110/120/220/240 V AC, 50/60 Hz.

IMPORTANT

Please record the serial number of this unit in the space below.

Model:

Serial No.:

The serial number is located on the rear of the unit. Retain this Owner's Manual in a safe place for future reference.

WARNING

TO REDUCE THE RISK OF FIRE OR ELECTRIC SHOCK, DO NOT EXPOSE THIS UNIT TO RAIN OR MOISTURE.

This unit is not disconnected from the AC power source as long as it is connected to the wall outlet, even if this unit itself is turned off. This state is called the standby mode. In this state, this unit is designed to consume a very small quantity of power.

For U.K. customers

If the socket outlets in the home are not suitable for the plug supplied with this appliance, it should be cut off and an appropriate 3 pin plug fitted. For details, refer to the instructions described below.

Note: The plug severed from the mains lead must be destroyed, as a plug with bared flexible cord is hazardous if engaged in a live socket outlet.

Special Instructions for U.K. Model

IMPORTANT

THE WIRES IN MAINS LEAD ARE COLOURED IN ACCORDANCE WITH THE FOLLOWING CODE:

Blue: NEUTRAL

Brown: LIVE

As the colours of the wires in the mains lead of this apparatus may not correspond with the coloured markings identifying the terminals in your plug, proceed as follows: The wire which is coloured BLUE must be connected to the terminal which is marked with the letter N or coloured BLACK. The wire which is coloured BROWN must be connected to the terminal which is marked with the letter L or coloured RED. Making sure that neither core is connected to the earth terminal of the three pin plug.

FREQUENCY STEP switch (General Model only)

Because the interstation frequency spacing differs in different areas, set the FREQUENCY STEP switch (located at the rear) according to the frequency spacing in your area. Before setting this switch, disconnect the AC power plug of this unit from the AC outlet.

WARNING

Do not change the **IMPEDANCE SELECTOR** switch setting while the power to this unit is on, otherwise this unit may be damaged.

IF THIS UNIT FAILS TO TURN ON WHEN THE STANDBY/ON SWITCH IS PRESSED;

The **IMPEDANCE SELECTOR** switch may not be set to either end. If so, set the switch to either end when this unit is in the standby mode.

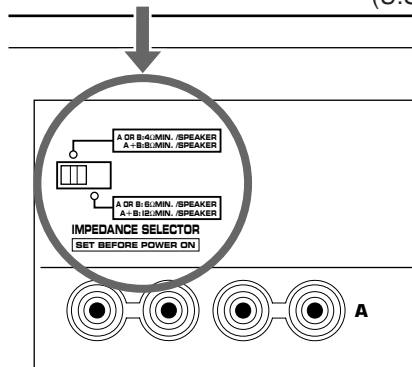
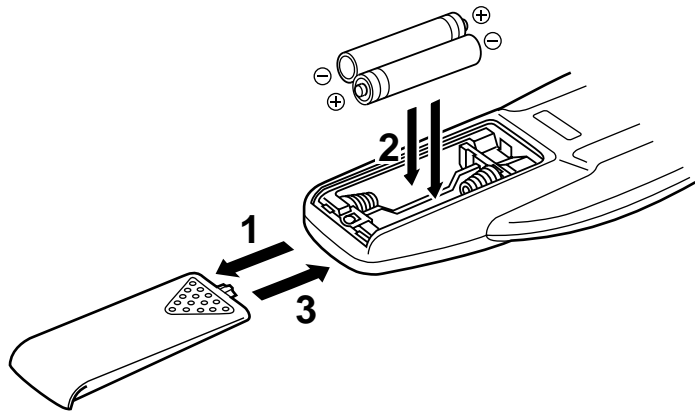
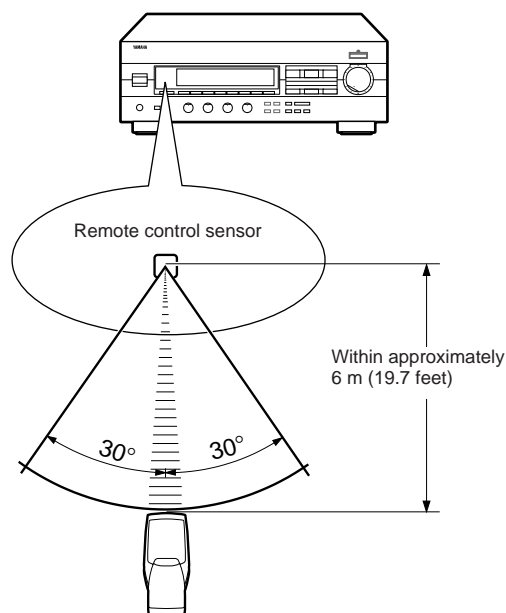
IMPEDANCE SELECTOR (U.S.A. model)**NOTES ABOUT THE REMOTE CONTROL TRANSMITTER****Battery installation****Remote control transmitter operation range****Battery replacement**

If you find that the remote control transmitter must be used closer to the main unit, the batteries are weak. Replace both batteries with new ones.

Notes

- Use only AA, R6, UM-3 batteries for replacement.
- Be sure the polarities are correct. (See the illustration inside the battery compartment.)
- Remove the batteries if the remote control transmitter is not used for an extended period of time.
- If batteries leak, dispose of them immediately. Avoid touching the leaked material or letting it come in contact with clothing, etc. Clean the battery compartment thoroughly before installing new batteries.

Notes

- There should be no large obstacles between the remote control transmitter and the main unit.
- If the remote control sensor is directly illuminated by strong lighting (especially an inverter type of fluorescent lamp etc.), it might cause the remote control transmitter not to work correctly. In this case, reposition the main unit to avoid direct lighting.

CONNECTIONS

Never plug in this unit and other components until all connections are completed.

CONNECTIONS WITH OTHER COMPONENTS

When making connections between this unit and other components, be sure all connections are made correctly, that is to say L (left) to L, R (right) to R, “+” to “+” and “-” to “-”. Also, refer to the owner’s manual for each component to be connected to this unit.

* If you have YAMAHA components numbered as 1, 3, 4, etc. on the rear panel, connections can be made easily by making sure to connect the output (or input) terminals of each component to the same-numbered terminals of this unit.

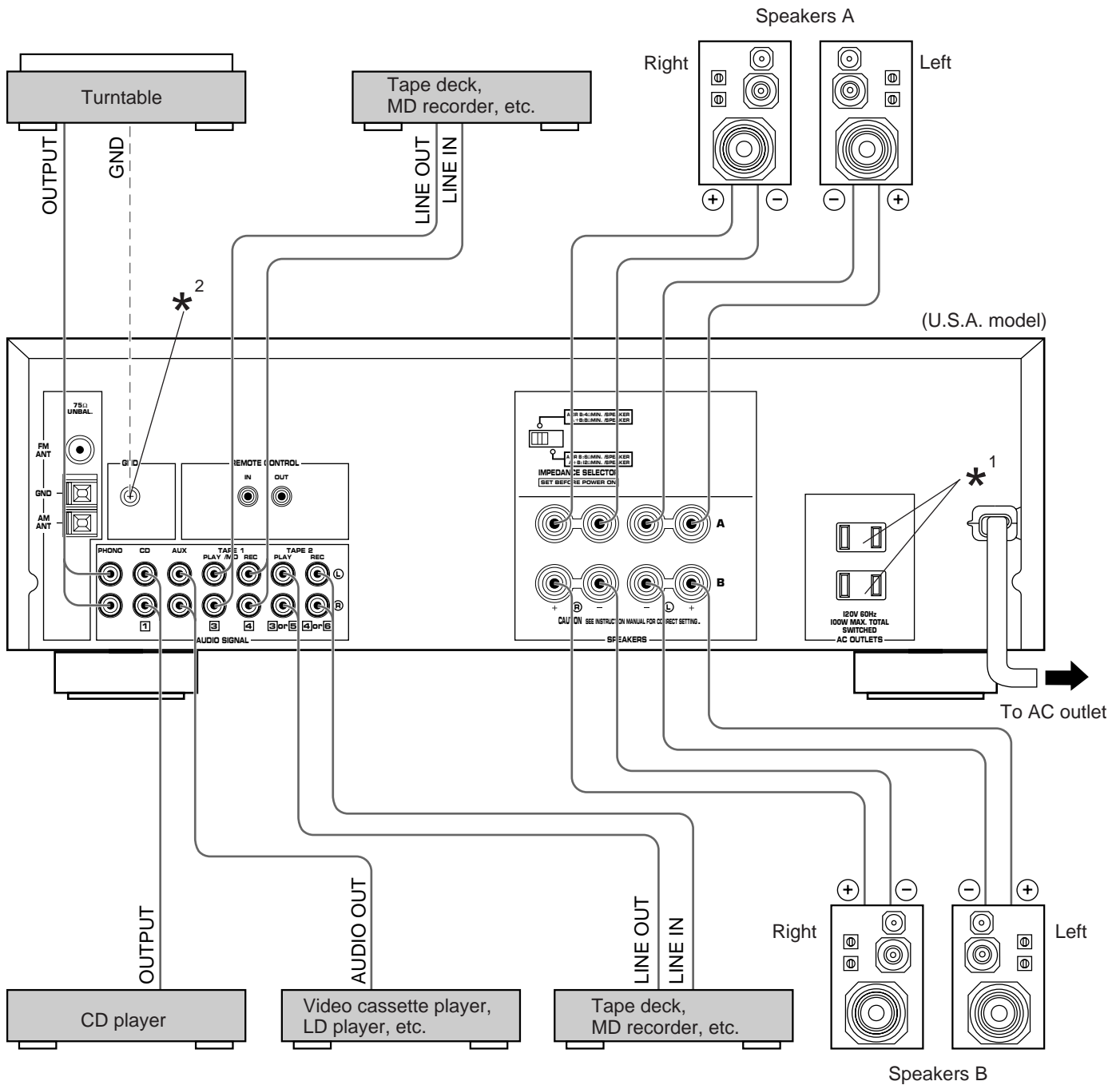

*¹, *²: See page 7.

*¹ AC OUTLETS (SWITCHED)

(U.S.A., Canada, Europe and General models)
..... 2 SWITCHED OUTLETS
(U.K. and Australia models) 1 SWITCHED OUTLET

Use these to connect the power cords from your components to this unit.

The power to the **SWITCHED** outlets is controlled by this unit's **STANDBY/ON** switch or the provided remote control transmitter's **STANDBY/ON** key. These outlets will supply power to any component whenever this unit is turned on.

The maximum power (total power consumption of components) that can be connected to the **SWITCHED AC OUTLETS** is 100 watts.

*² GND terminal (For turntable use)

Connecting the ground wire of the turntable to the **GND** terminal will normally minimize hum, but in some cases better results may be obtained with the ground wire disconnected.

CONNECTING SPEAKERS

Connect the **SPEAKERS** terminals to your speakers with wire of the proper gauge (cut as short as possible). If the connections are faulty, no sound will be heard from the speakers. Make sure that the polarity of the speaker wires is correct, that is the + and – markings are observed. If these wires are reversed, the sound will be unnatural and lack bass.

Caution

Do not let the bare speaker wires touch each other or any metal part of this unit. This could damage this unit and/or speakers.

How to Connect:

Red: positive (+)
Black: negative (–)

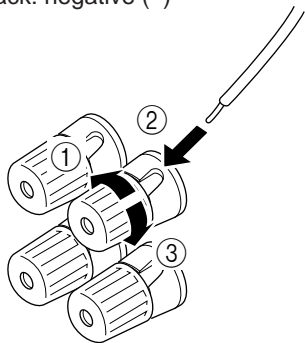

- ① Unscrew the knob.
- ② Insert the bare wire.
[Remove approx. 5mm (1/4") insulation from the speaker wires.]
- ③ Tighten the knob and secure the wire.

<U.S.A., Canada, Australia and General models only>

Banana Plug connections are also possible. Simply insert the Banana Plug connector into the corresponding terminal.

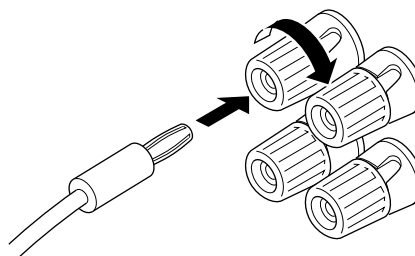

Use speakers with the specified impedance shown on the rear of this unit.

Note

One or two speaker systems can be connected to this unit. If you use only one speaker system, connect it to either the **SPEAKERS A** or **B** terminals.

IMPEDANCE SELECTOR switch

Be sure to switch the position only when the power to this unit is not on.

Select the position whose requirements your speaker system meets.

WARNING

Do not change the **IMPEDANCE SELECTOR** switch setting while the power to this unit is on, otherwise this unit may be damaged.

IF THIS UNIT FAILS TO TURN ON WHEN THE STANDBY/ON SWITCH IS PRESSED;

The **IMPEDANCE SELECTOR** switch may not be set to either end. If so, set the switch to either end when this unit is in the standby mode.

 (Left position)

If you use one pair of speakers, the impedance of each speaker must be 4Ω or higher.

If you use two pairs of speakers, the impedance of each speaker must be 8Ω or higher.

 (Right position)

<For U.S.A. model only>

If you use one pair of speakers, the impedance of each speaker must be 6Ω or higher.

If you use two pairs of speakers, the impedance of each speaker must be 12Ω or higher.

<For Canada model only>

The impedance of each speaker must be 6Ω or higher.

<Except U.S.A. and Canada models>

If you use one pair of speakers, the impedance of each speaker must be 8Ω or higher.

If you use two pairs of speakers, the impedance of each speaker must be 16Ω or higher.

IMPEDANCE SELECTOR (U.S.A. model)

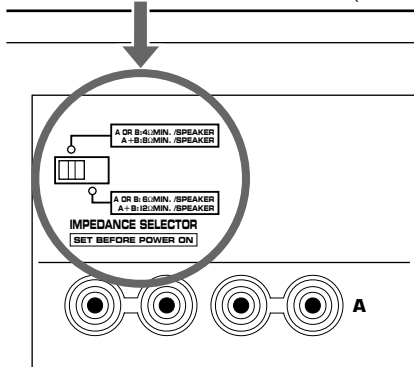

For Custom Installer For U.S.A., Canada and Australia models only

REMOTE CONTROL (IN, OUT) terminals

These terminals are used for custom installation system. When this unit is connected to the components for custom installation system, you can operate this unit with the system remote control.

Connect the **REMOTE CONTROL IN** terminal of this unit to the output terminal of the central controller for custom installation system.

By connecting the **REMOTE CONTROL OUT** terminal of this unit to the REMOTE CONTROL IN terminal of the other component, you can also operate the component with the system remote control. In this way, up to 6 components can be connected in series.

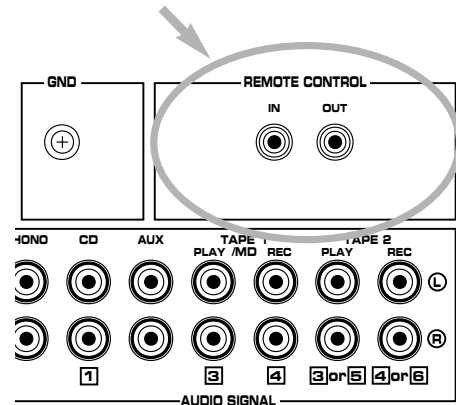

ANTENNA CONNECTIONS

- Each antenna should be connected to the designated terminal(s) correctly, referring to the following diagram.
- Both AM and FM indoor antennas are supplied to this unit. In general, these antennas will provide sufficient signal strength. Nevertheless, a properly installed outdoor antenna will give clearer reception than an indoor one. If you experience poor reception quality, an outdoor antenna may result in improvement.

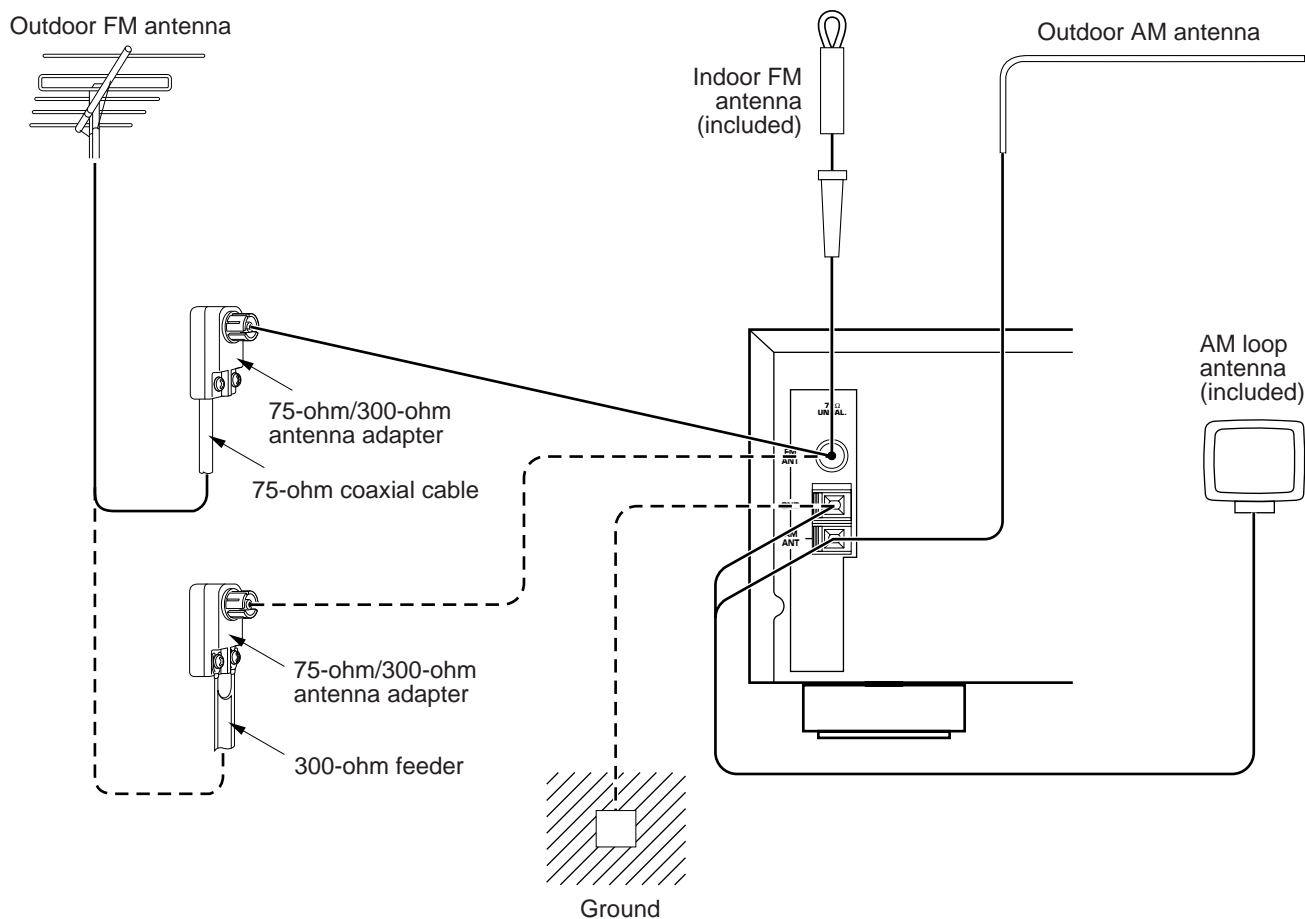

Connecting the AM loop antenna

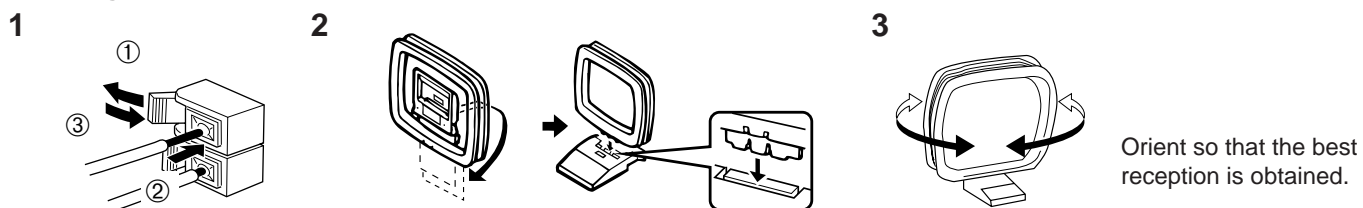

- * The AM loop antenna should be placed apart from the main unit. The antenna may be hung on a wall.
- * The AM loop antenna should be kept connected, even if an outdoor AM antenna is connected to this unit.

GND terminal

For maximum safety and minimum interference, connect the **GND** terminal to a good earth ground, which is a metal stake driven into moist earth.

Notes

- When connecting the indoor FM antenna, insert its connector into the **FM ANT** terminal firmly.
- If you need an outdoor FM antenna to improve FM reception quality, either 300-ohm feeder or coaxial cable may be used. In locations troubled by electrical interference, a coaxial cable is preferable.

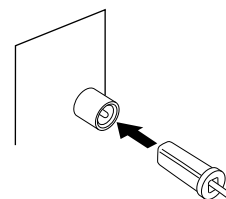

CONTROLS AND THEIR FUNCTIONS

FRONT PANEL

RX-496RDS and RX-496

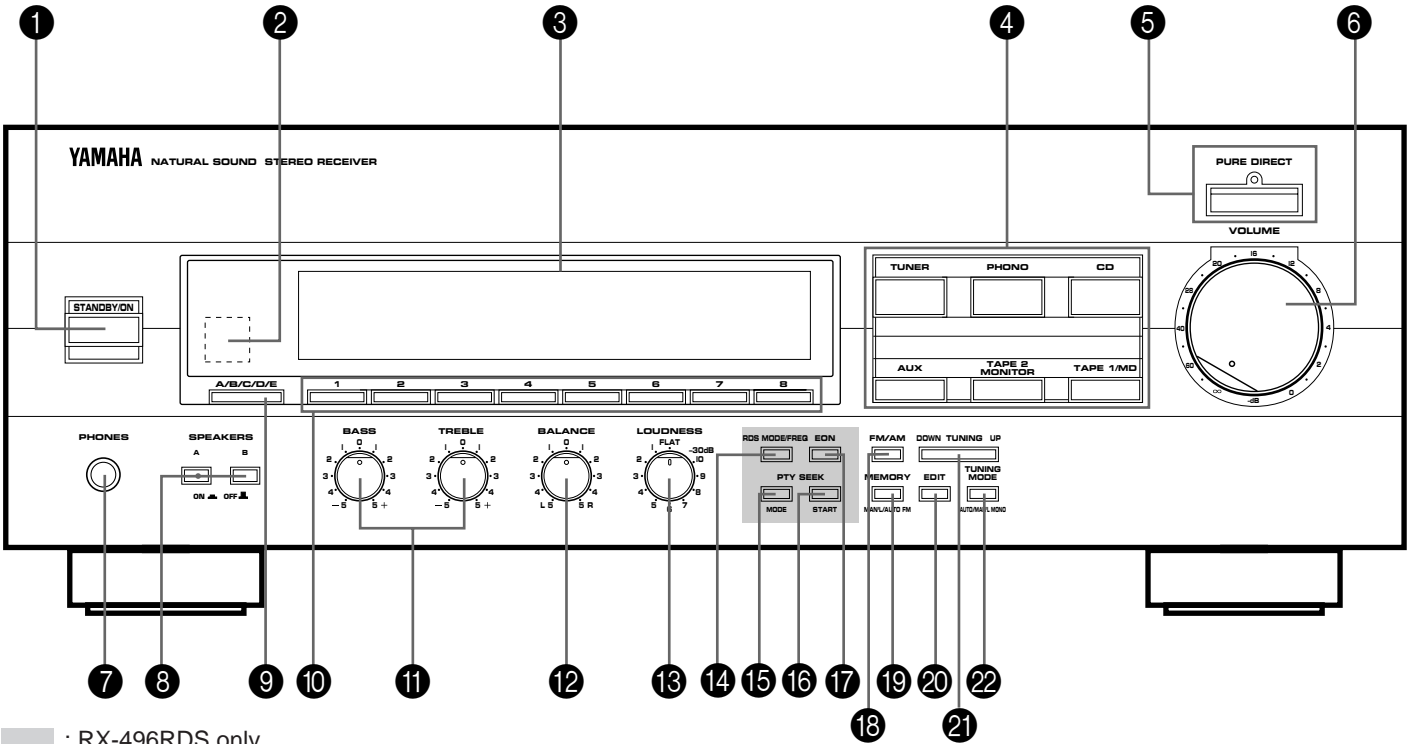

RX-396RDS and RX-396

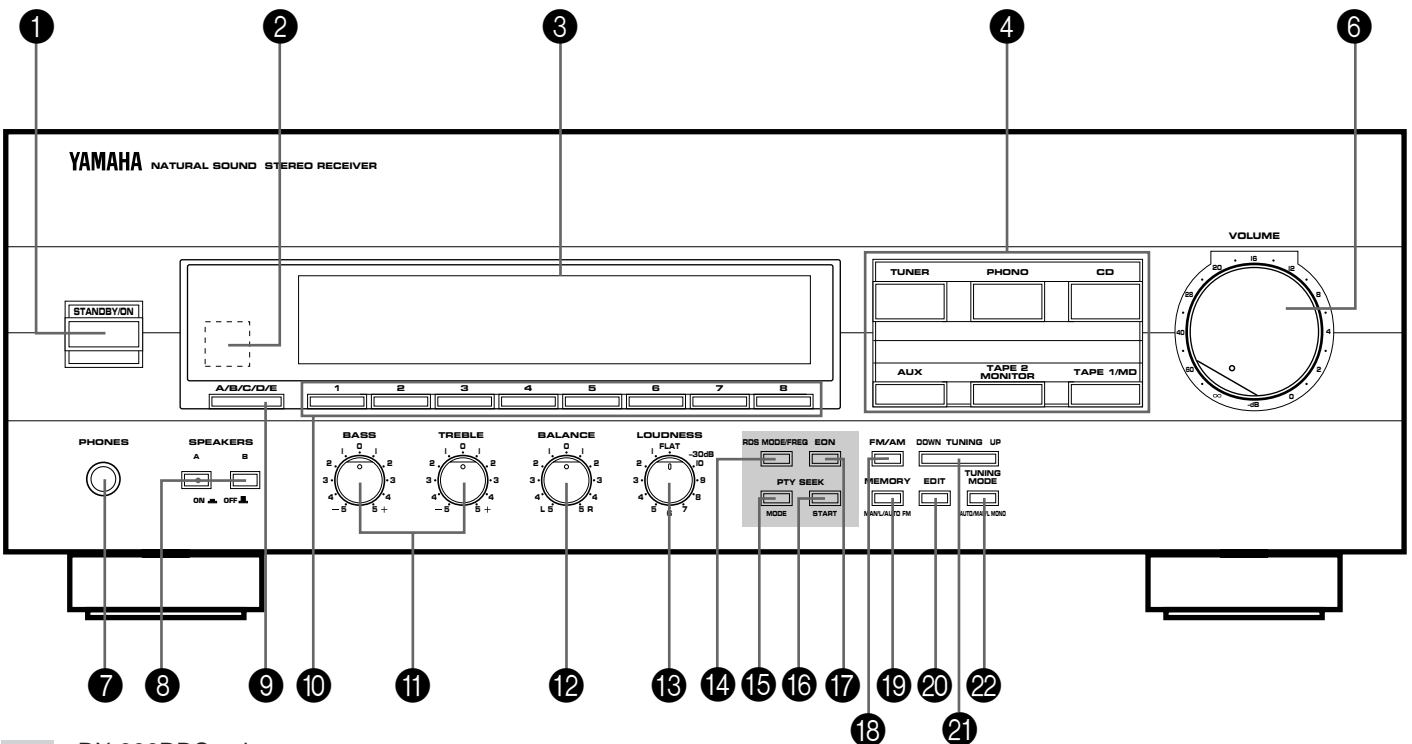

1 STANDBY/ON switch

Press this switch to turn on the power to this unit. Press it again to turn this unit into the standby mode.

Standby mode

In this state, this unit consumes a very small quantity of power to receive infrared-signals from the remote control transmitter.

2 Remote control sensor

Receives signals from the remote control transmitter.

3 Display panel

Shows various information. (For details, refer to page 13.)

4 Input selector buttons

Select a program source to listen to. When a button is pressed, the name of the selected source appears on the display.

5 PURE DIRECT switch and indicator**RX-496RDS and RX-496 only**

Press this switch so that the indicator lights up to listen to a source in the purest sound. (Refer to page 16 for details.)

6 VOLUME control

Used to raise or lower the volume level.

7 PHONES jack

When you listen with headphones, connect the headphones to the **PHONES** jack.

When listening with headphones privately, set both the **SPEAKERS A** and **B** switches to the **OFF** position.

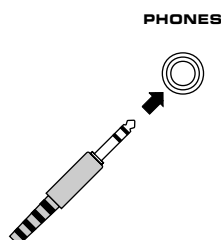
**8 SPEAKERS switches**

Set the switch **A** or **B** (or both **A** and **B**) for the speaker system (connected to this unit) you will use to the **ON** position. Set the switch for the speaker system you will not use to the **OFF** position.

9 A/B/C/D/E button

Press this button to select a desired group (A–E) of preset stations.

10 Preset station number selector buttons

Select a preset station number (1 to 8).

11 Tone controls**BASS**

Used to increase or decrease the low frequency response. The 0 position produces flat response.

TREBLE

Used to increase or decrease the high frequency response. The 0 position produces flat response.

12 BALANCE control

Adjusts the balance of the output volume to the left and right speakers to compensate for sound imbalance caused by speaker location or listening room conditions.

13 Continuously variable LOUDNESS control

Used to compensate for the human ears' loss of sensitivity to high and low-frequency ranges at low volume.

14 RDS MODE/FREQ button**RX-496RDS and RX-396RDS only**

When an RDS station is received, pressing this button changes the display mode into the PS mode, PTY mode, RT mode and/or CT mode (if the station employs these RDS data services), and frequency display in turn.

15 PTY SEEK MODE button**RX-496RDS and RX-396RDS only**

When this button is pressed, the unit turns into the PTY SEEK mode.

16 PTY SEEK START button**RX-496RDS and RX-396RDS only**

Press this button to begin searching for a station after the desired program type is selected in the PTY SEEK mode.

17 EON button**RX-496RDS and RX-396RDS only**

Press this button to select a desired program type (NEWS, INFO, AFFAIRS, SPORT) when you want to call a radio program of that program type automatically.

18 FM/AM button

Press this button to switch the reception band to FM or AM.

19 MEMORY (MAN'L/AUTO FM) button

When this button is pressed, the "MEMO" indicator flashes for about 5 seconds. While the indicator is flashing, select a desired preset station number by pressing the corresponding preset station number selector button to enter the displayed station into the memory.

When this button is held down for more than 3 seconds, the automatic preset tuning begins. (For details, refer to page 19.)

20 EDIT button

This button is used to exchange the places of two preset stations with each other.

21 TUNING DOWN/UP button

Used for tuning. Press the "UP" side to tune in to higher frequencies, and press the "DOWN" side to tune in to lower frequencies.

*** RX-496RDS and RX-396RDS only**

When this unit is in the PTY SEEK mode, pressing this switch changes the currently selected program type.

22 TUNING MODE (AUTO/MAN'L MONO) button

Press this button to switch the tuning mode to automatic or manual. To select the automatic tuning mode, press this button so that the "AUTO" indicator lights up on the display. To select the manual tuning mode, press this button so that the "AUTO" indicator goes off.

REMOTE CONTROL TRANSMITTER

The remote control transmitter provided with this unit is designed to control all the most commonly used functions of this unit. If the CD player and tape deck connected to this unit are YAMAHA components designed for remote control compatibility, this remote control transmitter will also control various functions of each component.

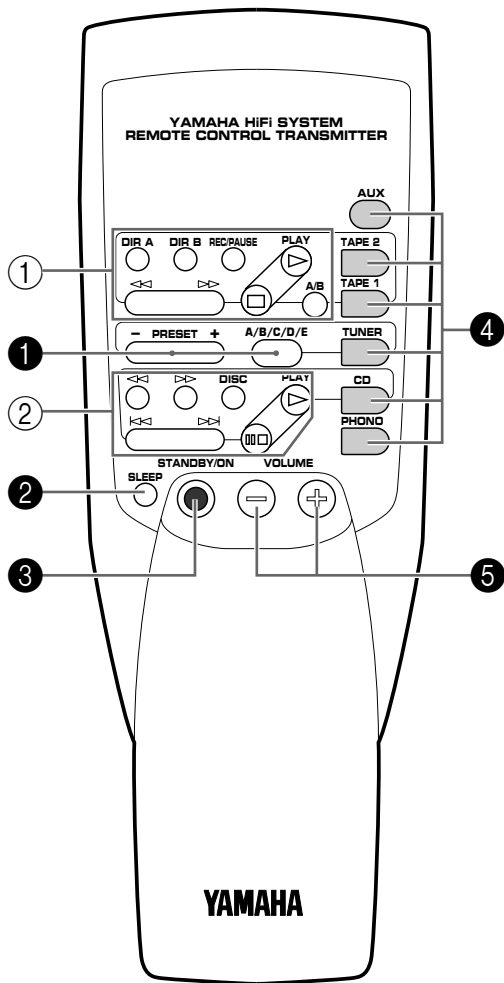

For Control of This Unit

① Tuner keys

Control tuner.

+: Selects higher preset station number.

-: Selects lower preset station number.

A/B/C/D/E: Selects the group (A – E) of preset station numbers.

② SLEEP timer key

This unit is automatically turned into the standby mode one hour after this key is pressed (so that "SLEEP" indicator lights up).

③ STANDBY/ON key

Turns the power to this unit on and turns this unit into the standby mode alternately.

④ Input selector keys

Select input source.

⑤ VOLUME +/- keys

Turn the volume level up/down.

For Other Component Control

Identify the remote control transmitter keys with your component's keys. If these keys are identical, their functions will be the same. On each key function, refer to the corresponding instruction on your component's manual.

① Tape deck keys

Control tape deck.

* **DIR A, B** and **A/B** are applicable only to double cassette tape deck.

* For a single cassette deck with automatic reverse function, pressing **DIR A** will reverse the direction of tape running.

② CD player keys

Control compact disc player.

* **DISC** is applicable only to compact disc changer.

DISPLAY PANEL

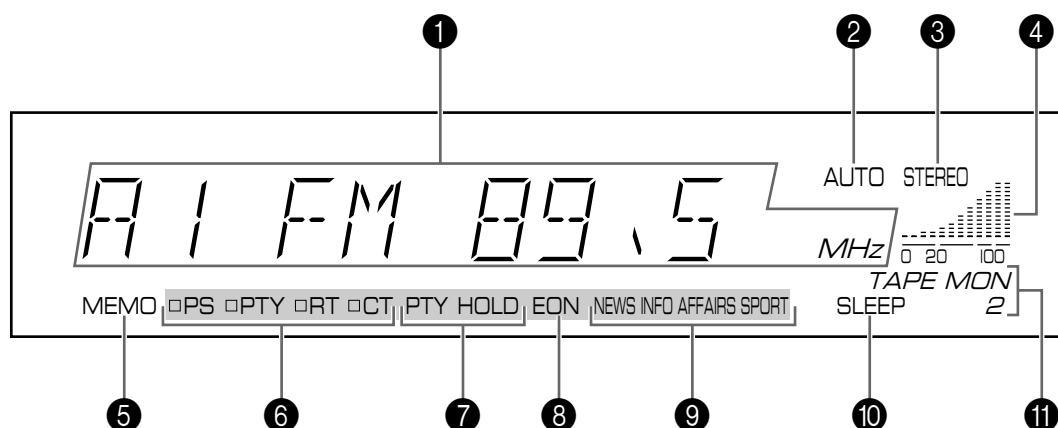

■ : RX-496RDS and RX-396RDS only

1 Multi-information display

Displays various information, for example station frequency, preset station number and name of selected input source.

2 AUTO indicator

Lights up when this unit is in the automatic tuning mode.

3 STEREO indicator

Lights up when an FM stereo broadcast with sufficient signal strength is received.

4 Signal-level meter

Indicates the signal level of the received station. If multipath interference is detected, the indication decreases.

5 MEMO indicator

When the **MEMORY** button is pressed, this indicator flashes for about 5 seconds. While this indicator is flashing, the displayed station can be programmed to the memory by using the **A/B/C/D/E** button and the preset station number selector buttons.

6 RDS mode indicators

RX-496RDS and RX-396RDS only

The name(s) of RDS mode(s) employed by the currently received RDS station light(s) up. Illumination of the indicator on the head of a name shows that the corresponding RDS mode is now selected.

7 PTY HOLD indicator

RX-496RDS and RX-396RDS only

Lights up while the search is performed in the PTY SEEK mode.

8 EON indicator

RX-496RDS and RX-396RDS only

Lights up when an RDS station that employs the EON data service is received.

9 Program type name indicators

RX-496RDS and RX-396RDS only

The name selected in the EON mode lights up.

10 SLEEP indicator

Lights up while the built-in SLEEP timer is functioning.

11 TAPE MON 2 indicator

Lights up when the tape deck (or MD recorder etc.) connected to the TAPE 2 terminals on the rear of this unit is selected as the input source by pressing the **TAPE 2 MONITOR** button.

From page 14 to 25, this manual describes how to operate this unit mainly by using the front panel control parts. To operate this unit on the remote control transmitter, use the corresponding keys on the remote control transmitter.

BASIC OPERATIONS

TO PLAY A SOURCE

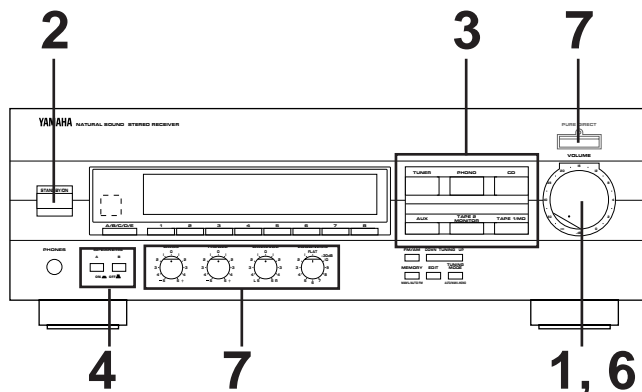

 : RX-496RDS and RX-496 only

1

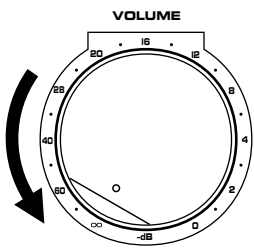

Set to the "∞" position.

2 Turn the power on.



3 Select the desired input source by using the input selector buttons.

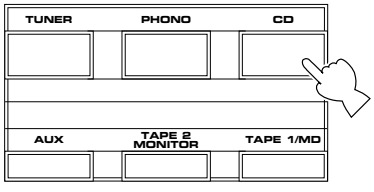

* The name of the selected input source will appear on the display.

4 Select the speakers to be used.

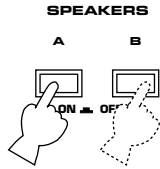

* If you use two speaker systems, press both the A and B switches.

5 Play the source. (For detailed information on the tuning operation, refer to page 17.)

6

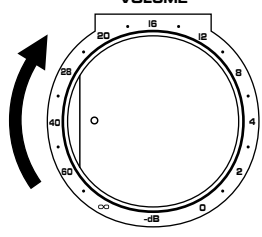

Adjust to the desired output level.

7 If desired, adjust the **BASS**, **TREBLE**, **BALANCE** and **LOUDNESS** controls, or use the **PURE DIRECT** switch (for RX-496RDS and RX-496 only). For details, refer to page 16.

Notes on using the input selector buttons

- Note that pressing each input selector button selects the source which is connected to the corresponding input terminals on the rear panel.
- The selection of **TAPE 2 MONITOR** cannot be canceled by pressing another input selector button. To cancel it, press **TAPE 2 MONITOR** again so that the "TAPE MON 2" indicator disappears from the display. When you select a button other than **TAPE 2 MONITOR**, make sure that the "TAPE MON 2" indicator is not illuminated on the display.

When you finish using this unit

Press the **STANDBY/ON** switch on the front panel again or the **STANDBY/ON** key on the remote control transmitter to turn this unit into the standby mode.

TO RECORD (OR DUB) A SOURCE TO TAPE (OR MD)

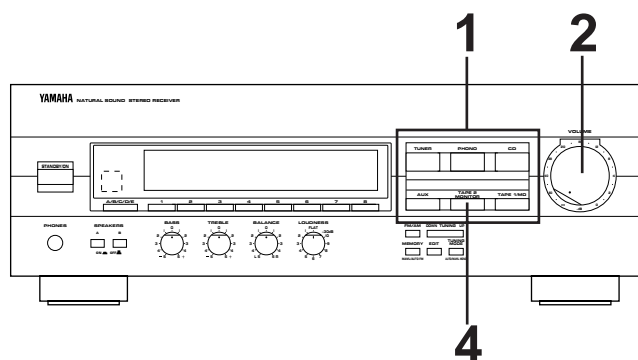

- 1** Select the source to be recorded.

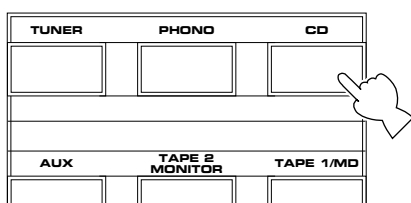

* When you select **TUNER**, **PHONO**, **CD**, **AUX** or **TAPE 1/MD**, make sure that **TAPE 2 MONITOR** is not also selected.

- 2** Play the source and then turn the **VOLUME** control up to confirm the input source. (For detailed information on the tuning operations, refer to the page 17.)

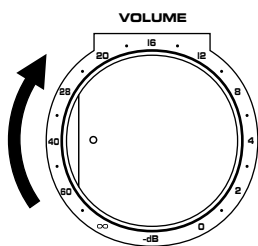

- 3** Begin recording on the tape deck (or MD recorder etc.) connected to this unit.

- 4** If the tape deck (or MD recorder etc.) connected to the **TAPE 2** terminals on the rear of this unit is used for recording, you can monitor the sounds being recorded by pressing **TAPE 2 MONITOR** so that the "TAPE MON 2" indicator lights up on the display.

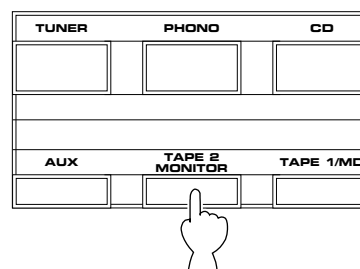

Note
VOLUME, **BASS**, **TREBLE**, **BALANCE** and **LOUDNESS** controls have no effect on the material being recorded.

Selecting the SPEAKER system

Because one or two speaker systems can be connected to this unit, the **SPEAKERS** switches allow you to select speaker system **A** or **B**, or both at once.

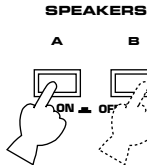

Adjusting the BALANCE control

Adjust the balance of the output volume to the left and right speakers to compensate for sound imbalance caused by speaker location or listening room conditions.



Adjusting the BASS and TREBLE controls

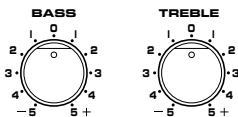

BASS : Turn this clockwise to increase (or counter-clockwise to decrease) the low frequency response.

TREBLE : Turn this clockwise to increase (or counter-clockwise to decrease) the high frequency response.

Adjusting the continuously variable LOUDNESS control

This control provides compensation for the human ears' loss of sensitivity to high and low-frequency ranges at low volume. This control is adjustable to retain full tonal range at any volume level.

1

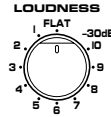

Set to the "FLAT" position.

2

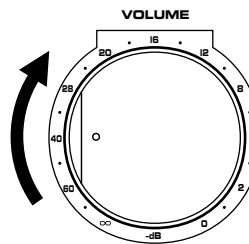

Set to the loudest listening level that you would listen in.

3

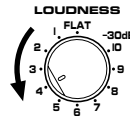

Turn until the desired volume is gained.

Using the PURE DIRECT switch

RX-496RDS and RX-496 only

You can enjoy the purest possible sound from your audio sources by pressing this switch so that the indicator lights up. By doing so, the audio signal bypasses the **BASS**, **TREBLE**, **BALANCE** and **LOUDNESS** controls, eliminating any alteration to the audio signal.

To cancel this function, press it again so that the indicator goes off.

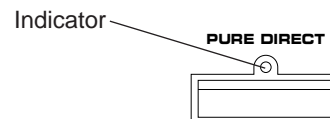

TUNING OPERATIONS

Normally, if station signals are strong and there is no interference, quick automatic-search tuning (AUTOMATIC TUNING) is possible. However, if signals of the station you want to select are weak, you must tune to it manually (MANUAL TUNING).

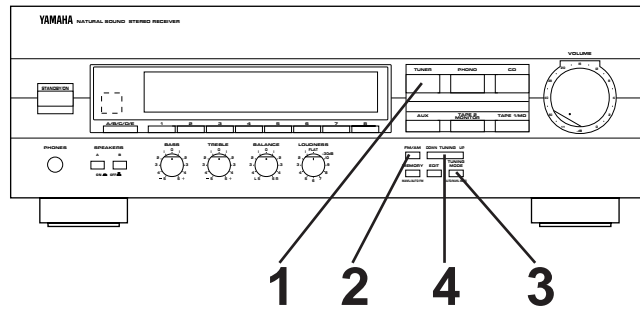

AUTOMATIC TUNING

1 Select "TUNER" as the input source.

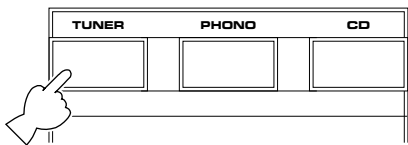

2 Select the reception band (FM or AM) confirming it on the display.

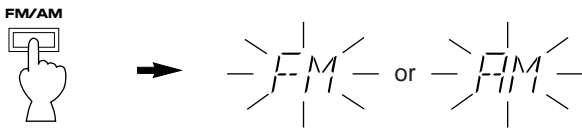

3 Turn the "AUTO" indicator off.

4 To tune to a higher frequency, press the right side once. To tune to a lower frequency, press the left side once.

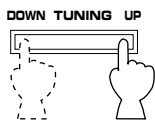

- * If the station where tuning search stops is not the desired one, press again.
- * If the tuning search does not stop at the desired station (because the signals of the station are weak), change to the MANUAL TUNING method.

MANUAL TUNING

1 Select "TUNER" as the input source.

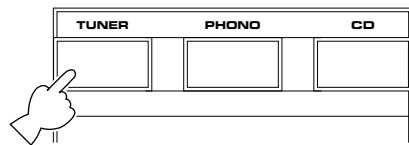

2 Select the reception band (FM or AM) confirming it on the display.

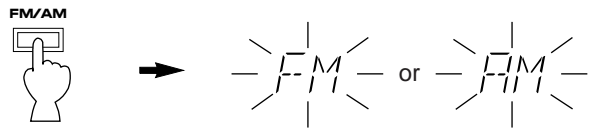

3 Turn the "AUTO" indicator off.

4 Tune to a desired station manually.

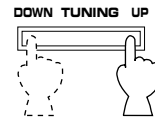

* To continue tuning search, hold down the button.

Notes

- If you tune to an FM station manually, it is received in monaural mode automatically to increase the signal quality.
- **RX-496RDS and RX-396RDS only**

When tuned in to a station, the frequency of the received station is shown on the display. If an RDS station that employs PS data service is received, the frequency is then replaced by the station name. Refer to page 23 for details.

PRESET TUNING

MANUAL PRESET TUNING

This unit can store station frequencies selected by tuning operation. With this function, you can recall any desired station only by selecting the preset station number where it is stored. Up to 40 stations (8 stations x 5 groups) can be stored.

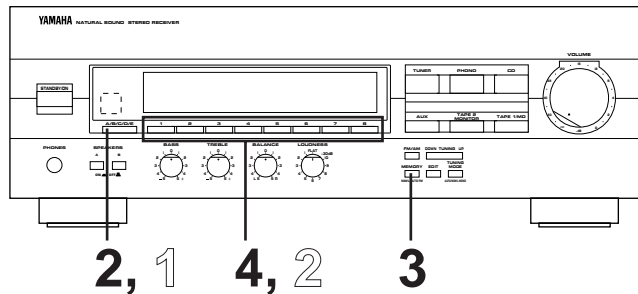

To store stations

1 Tune to a desired station.
(Refer to the previous page for tuning procedure.)

2 Select a desired group (A – E) of preset stations confirming it on the display.

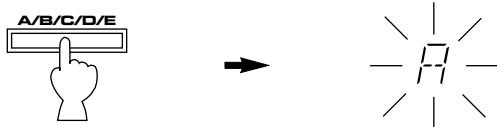

3 **MEMORY** indicator flashes on and off for about 5 seconds.

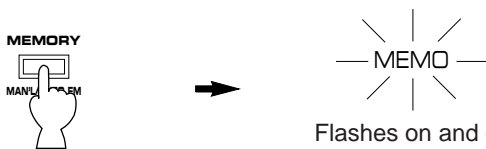

4 Select a preset station number where you want to program the station before the “MEMO” indicator goes off from the display.

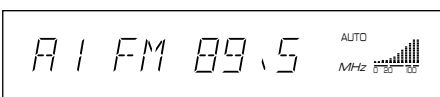
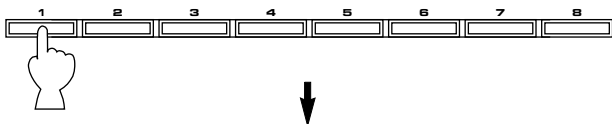

Shows the displayed station has been programmed to A1.

- * In the same way, program other stations to A2, A3 ... A8.
- * You can program more stations to preset station numbers of other groups in the same way by selecting other groups in step 2.

To recall a preset station

1 Select the group of preset stations.

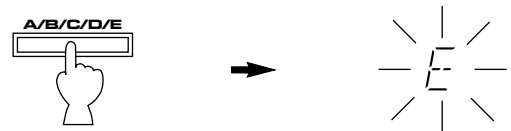

2 Select the preset station number.

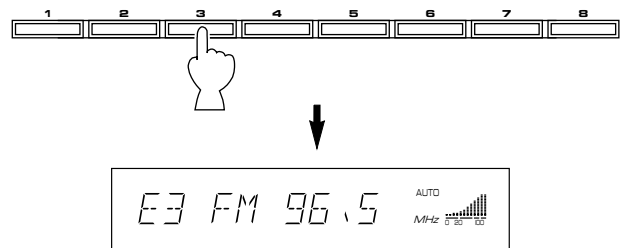

Notes

- A new setting can be programmed in place of the former one.
- For presets, the setting of the reception mode (stereo or monaural) is stored along with the station frequency.

Memory back-up

The memory back-up circuit prevents the programmed data from being lost even if this unit is turned into the standby mode or the power plug is disconnected from the AC outlet or the power is cut due to temporary power failure. If, however, the power is cut for more than one week, the memory may be erased. If so, it can be re-programmed by simply following the PRESET TUNING steps.

AUTOMATIC PRESET TUNING

You can make use of an automatic preset tuning function for FM stations. With this function, this unit performs automatic tuning and stores FM stations with strong signals sequentially. Up to 40 stations are stored automatically in the same way as in the manual preset tuning method on page 18.

* **RX-496RDS and RX-396RDS only**

Only RDS stations can be stored by this function. (Refer to page 21 to 25 for details about RDS stations.)

To store stations

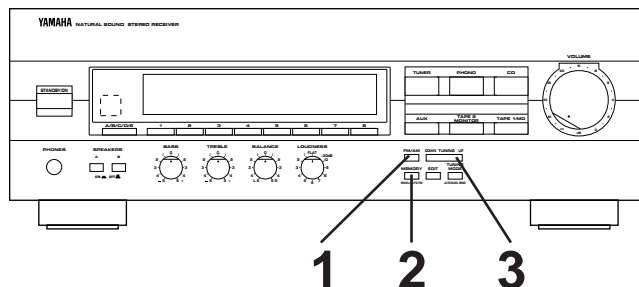

1



2

Press and hold for more than 3 seconds.

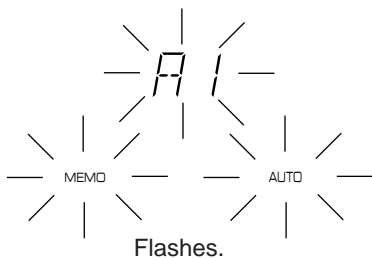

3

DOWN TUNING UP

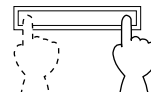

To tune to higher frequencies, press right side once.
To tune to lower frequencies, press left side once.

* If the **TUNING** button is not pressed, in a while, the automatic preset tuning begins automatically toward higher frequencies.

The automatic preset tuning begins from the frequency currently displayed. Received stations are programmed to A1, A2 ... A8 sequentially.

* If more than 8 stations are received, they are also programmed to the preset station numbers of other groups (B, C, D and E) in that order.

If you want to store the first station received by the automatic preset tuning to a desired preset station number:

If, for example, you want to store the first received station to C5, select "C5" by using the **A/B/C/D/E** button and the preset station number selector buttons after pressing the **MEMORY** button in step 2. Then press the **TUNING** button. The first received station is stored to C5, and next stations to C6, C7 ... sequentially.

If stations are stored up to E8, the automatic preset tuning finishes automatically.

When the automatic preset tuning is finished;
The display shows the frequency of the last preset station. Check the contents and the number of preset stations by following the procedure of the section "To recall a preset station" on page 18.

To recall a preset station

Simply follow the procedure of the section "To recall a preset station" on page 18.

*** RX-496RDS, RX-396RDS**

A recalled station is shown by the frequency or station name on the display.

*** RX-496, RX-396**

A recalled station is shown by the frequency on the display.

Notes

- You can replace a preset station by another FM or AM station manually by simply following the procedure of the section "To store stations" on page 18.

RX-496RDS and RX-396RDS only

- The automatic preset tuning search will be performed through all RDS network frequencies until stations are stored up to E8. If the number of received stations is not enough to be stored up to E8, the search is finished automatically after searching all frequencies.
- With this function, only RDS stations with sufficient signal strength are stored automatically. If the station you want to program is weak in signal strength, tune to it in monaural manually and program it by following the procedure of the section "To store stations" on page 18.
- * There may be a case that this function cannot receive a station which could be received by the automatic tuning method. This is because this function receives a large volume of PI (Program Identification) data along with the station.

RX-496 and RX-396 only

- If the number of received stations is not enough to be stored up to E8, the search is finished automatically after searching all frequencies.
- With this function, only FM stations with sufficient signal strength are stored automatically. If the station you want to program is weak in signal strength, tune to it in monaural manually and program it by following the procedure of the section "To store stations" on page 18.

EXCHANGING PRESET STATIONS

You can exchange the places of two preset stations with each other as shown below.

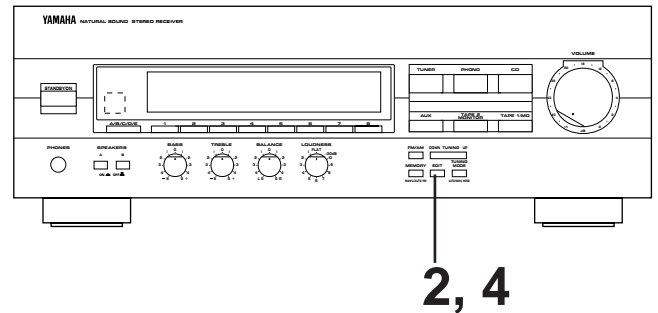

Example)

If you want to shift the preset station on E1 to A5, and vice versa.

| | |
|----------|---|
| 1 | Recall the preset station on E1 (by following the method of "To recall a preset station" on page 18). |
| 2 | |
| 3 | Recall the preset station on A5 by following the same method as in step 1. |
| | |
| 4 | |

In areas where RDS broadcasts cannot be received, the RDS broadcast functions do not operate. (Skip the procedures from page 21 to 25.)

RECEIVING RDS STATIONS RX-496RDS and RX-396RDS only

RDS (Radio Data System) is a data transmission system gradually being introduced by FM stations in many countries. Stations using this system transmit an inaudible stream of data in addition to the normal radio signal.

RDS data contains various information, such as PI (Program Identification), PS (Program Service name), PTY (Program Type), RT (Radio Text), CT (Clock Time), EON (Enhanced Other Networks), etc.

RDS function is carried out among the network stations.

* This unit utilizes PI, PS, PTY, RT, CT and EON to receive RDS broadcast stations.

Displaying RDS data

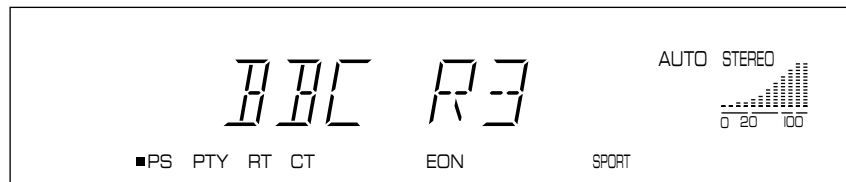

This unit can be turned into the following five modes to display RDS data.

PS (Program Service name) mode:

Displays the name of the RDS station now being received instead of the frequency.

PTY (Program Type) mode:

Displays the type of the program on the RDS station now being received. There are 15 program types to classify RDS stations. Refer to the next page for details.

RT (Radio Text) mode:

Displays information about the program (such as title of the song, name of the singer, etc.) on the RDS station now being received.

CT (Clock Time) mode:

Displays current time. This signal comes from the RDS station now being received.

EON (Enhanced Other Networks) mode:

Automatically receives a program of the designated program type when its broadcast starts, in place of the program now being received. When the broadcast of the called program ends, the previously received program (or another program on the same station) is recalled.

Program types in the PTY mode

| | | | |
|----------------|---|-----------------|---|
| NEWS | News: Short accounts of facts, events and publicly expressed views, reportage and actuality. | VARIED | Varied: Used for mainly speech-based programs usually of light-entertainment nature, not covered by above categories. Examples are: quizzes, panel games, personality interviews, comedy and satire. |
| AFFAIRS | Current affairs: Topical program expanding or enlarging upon the news, generally in different presentation style or concept, including documentary debate, or analysis. | POP M | Pop: Commercial music, which would generally be considered to be of current popular appeal, often featuring in current or recent record sales charts. |
| INFO | Information: Program whose purpose is to impart advice in the widest sense, including meteorological reports and forecasts, consumer affairs, medical help, etc. | ROCK M | Rock: Contemporary modern music, usually written and performed by young musicians. |
| SPORT | Sport: Program concerned with any aspect of sport. | M.O.R. M | M.O.R.: (Middle of the Road Music). Common term to describe music considered to be "easy-listening", as opposed to Pop, Rock or Classical. Music in this category is often but not always, vocal, and usually of short duration (<5 min.) |
| EDUCATE | Education: Program intended primarily to educate, of which the formal element is fundamental. | LIGHT M | Light classics: Classical Musical for general, rather than specialist appreciation. Examples of music in this category are instrumental music, and vocal or choral works. |
| DRAMA | Drama: All radio plays and serials. | CLASSICS | Serious classics: Performances of major orchestral works, symphonies, chamber music etc., and including Grand Opera. |
| CULTURE | Culture: Programs concerned with any aspect of national or regional culture, including religious affairs, philosophy, social science, language, theatre, etc. | OTHER M | Other music: Musical styles not fitting into any of the above categories. Particularly used for specialist music, of which Jazz, Rhythm & Blues, Folk, Country, and Reggae are examples. |
| SCIENCE | Science: Programs about the natural sciences and technology. | | |

Changing the RDS modes

When an RDS station is received, "PS", "PTY", "RT" and/or "CT" that correspond to the RDS data services employed by the station light up on the display. By pressing the **RDS MODE/FREQ** button once or more, you can change the display mode among the RDS modes employed by the received station in the order shown below. (The RDS mode not employed by the station cannot be selected.) Illumination of the indicator on the head of the name of an RDS mode shows that the corresponding RDS mode is now selected.

* When an RDS station is received, do not press the **RDS MODE/FREQ** button until one or more names of RDS modes light up on the display. If the button is pressed before one or more names light up on the display, the mode cannot be changed. This is because the unit has not received all of the RDS data on the station yet.

* If no name of RDS mode lights up on the display, the mode cannot be changed.

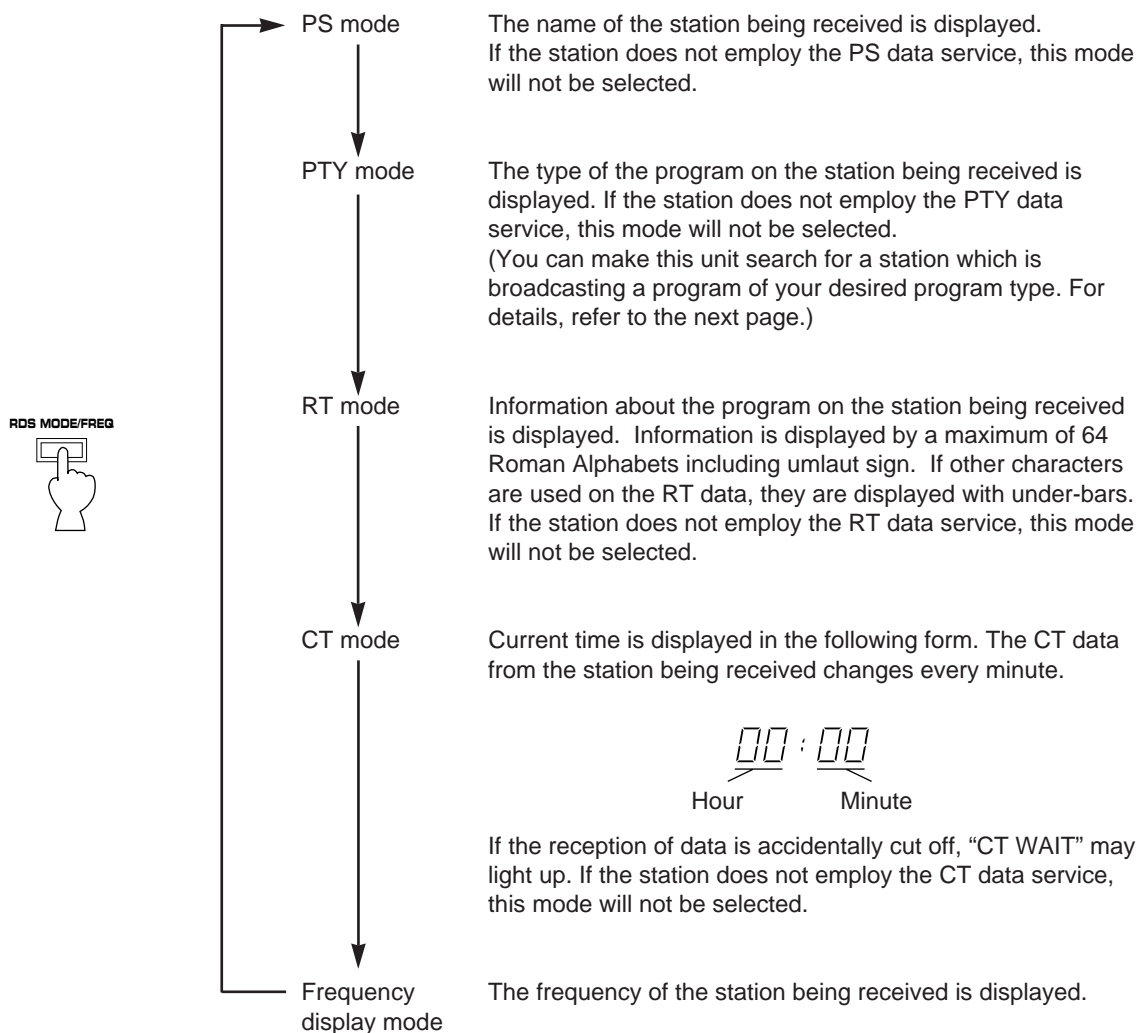

Notes

- RDS data service cannot be utilized by this unit if the received signal is not strong enough. Especially, the RT (Radio Text mode) needs much data to be received, so it may occur that RT mode cannot be displayed even if other RDS modes (PS, PTY, etc.) are displayed.
- There may be a case that RDS data reception is not possible due to poor reception conditions. If so, press the **TUNING MODE** button so that the "AUTO" indicator goes off from the display. Though the reception mode is changed to monaural by this operation, when you change the display to an RDS mode, RDS data may be displayed.
- If the signal strength becomes weakened by external interference during receiving an RDS station, the RDS data service may be cut off suddenly and "...WAIT" will light up on the display.

Calling a program of your desired program type from among preset RDS stations (PTY SEEK)

By designating a program type, the unit automatically searches all preset stations for an RDS station which broadcasts a program of that program type.

* There are 15 program types to classify RDS stations. For details, refer to page 22.

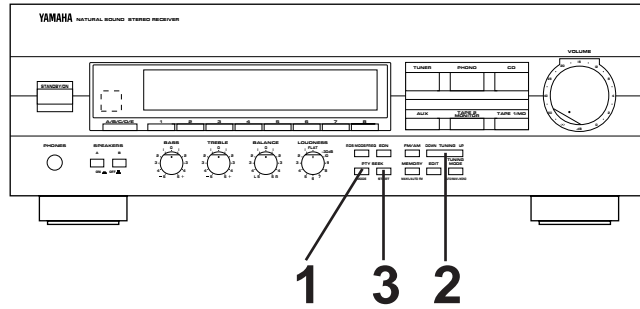

1 Turn the unit into the PTY SEEK mode.

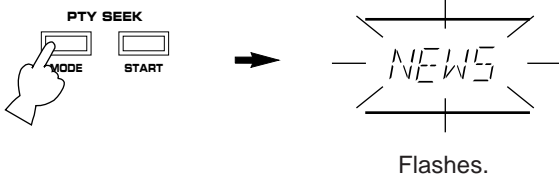

* The program type of the station now being received or "NEWS" flashes on the display.

2 Select the desired program type.

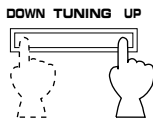

3 Begin searching all preset RDS stations.

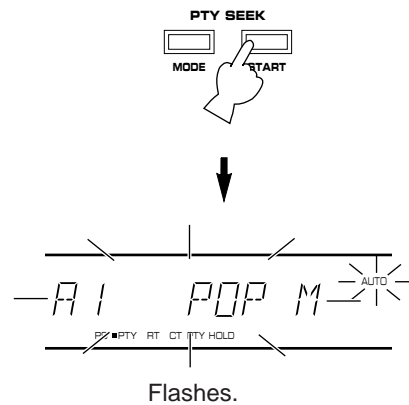

* The "PTY HOLD" indicator lights up on the display.

- If a station which broadcasts a program of the program type you selected is found, the unit stops at the station and the display shows its frequency after showing the name of the program type in a flash.
- If the called station is not the desired one, press the **PTY SEEK START** button once more. The unit begins searching for another station which broadcasts a program of the same program type.
- To stop the search, press the **PTY SEEK START** button once more.

To cancel this function

If the **PTY SEEK MODE** button is pressed once more, the PTY SEEK mode will be canceled.

Making this unit call a program of your desired program type automatically when its broadcast starts

This function uses the EON (Enhanced Other Networks) data service on the RDS station network. Only by selecting a desired program type (NEWS, INFO, AFFAIRS or SPORT), this unit automatically searches all preset RDS stations for a station that broadcasts a program of that program type in the background, and, if found, receives a program when its broadcast starts in place of the program now being received.

* This function can be used only when an RDS station that employs the EON data service is received. (When such a station is received, the "EON" indicator lights up on the display.)

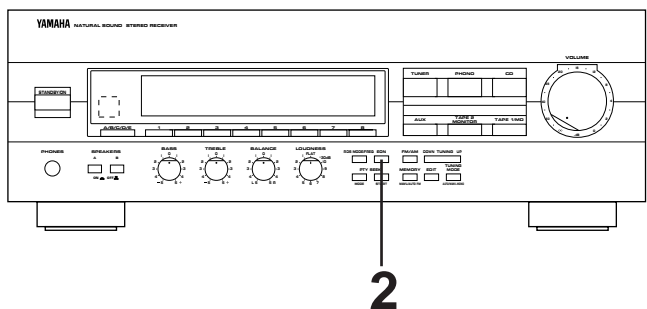

1 Make sure that the "EON" indicator is illuminated on the display.

The display shows 'AS NIR 1 5H'. Below the display, the 'EON' indicator is lit, while 'PS', 'PTY', 'RT', and 'CT' are not.

* If the "EON" indicator is not illuminated on the display, receive an (or another) RDS station so that the "EON" indicator lights up on the display.

3 When the broadcast of the called program ends, the previously received program (or another program of the same station) is recalled.

The display shows 'AS NIR 1 5H'. Below the display, the 'EON' indicator is lit, while 'PS', 'PTY', 'RT', and 'CT' are not.

To cancel this function
Press the **EON** button once or more, so that no program type name lights up on the display.

2 Select a desired program type, NEWS, INFO, AFFAIRS or SPORT.

A hand icon is shown pressing the 'EON' button. An arrow points to the display, which now shows 'AS NIR 1 5H'. Below the display, both 'EON' and 'NEWS' indicators are lit.

Press once or more. Lights up.

The search is performed among all preset RDS stations in the background. If a program is found, the program will be automatically received when it starts broadcasting.

The display shows '82 NIR 2'. Below the display, the 'EON' and 'NEWS' indicators are shown with diagonal lines through them, indicating they are flashing.

Flashes.

TROUBLESHOOTING

If the unit fails to operate normally, check the following points to determine whether the fault can be corrected by the simple measures suggested. If it cannot be corrected, or if the fault is not listed in the SYMPTOM column, disconnect the power cord and contact your authorized YAMAHA dealer or service center for help.

| | SYMPTOM | CAUSE | REMEDY |
|--|--|--|---|
| Amplifier | The unit fails to turn on when the STANDBY/ON switch is pressed, or turns into the standby mode suddenly soon after the power is turned on. | Power cord is not plugged in or is not completely inserted. | Firmly plug in the power cord. |
| | | The IMPEDANCE SELECTOR switch on the rear panel is not set to either end. | Set the switch to either end when this unit is in the standby mode. |
| | It happens that this unit does not work normally. | There is an influence of strong external noise (lightning, excessive static electricity, etc.) or a misoperation on this unit while using this unit. | Turn this unit into the standby mode and disconnect the AC power cord from the AC outlet. After about 30 seconds pass, connect the power and operate this unit again. |
| | No sound. | Incorrect output cord connections. | Connect the cords properly. If the problem persists, the cords may be defective. |
| | | Appropriate input source is not selected. | Select an appropriate input source with the input selector buttons. |
| | | The SPEAKERS switches are not set properly. | Set the SPEAKERS switch which corresponds to the speakers to be used to the ON position. |
| | | Speaker connections are not secure. | Secure the connections. |
| | The sound suddenly goes off. | The protection circuit has been activated because of short circuit etc. | Turn this unit into the standby mode, and then turn on to reset the protection circuit. |
| | | The SLEEP timer has functioned. | Cancel the SLEEP timer function. |
| | Only one side speaker outputs the sound. | Incorrect setting of the BALANCE control. | Adjust it to the appropriate position. |
| | | Incorrect cord connections. | Connect the cords properly. If the problem persists, the cords may be defective. |
| | There is a lack of bass, and no ambience. | The + and – wires are connected in reverse to this unit or speakers. | Connect the speaker wires in the correct phase (+ and –). |
| | Sound “hums”. | Incorrect cord connections. | Firmly connect the audio plugs. If the problem persists, the cords may be defective. |
| | | No connection from the turntable to the GND terminal. | Make the GND connection between the turntable and this unit. |
| | Sound level is low. | The LOUDNESS control is functioning. | Set the LOUDNESS control to the FLAT position. |
| The volume level is low while playing a record. | The record is being played on a turntable with an MC cartridge. | The player should be connected to the unit through the MC head amplifier. | |
| The volume level cannot be increased, or sound is distorted. | The component connected to the REC terminals of this unit is turned off. | Turn the power to the component on. | |
| FM | FM stereo reception is noisy. | Because of the characteristics of FM stereo broadcasts, this is limited to cases where the transmitter is too far away or the antenna input is poor. | Check the antenna connections. Try using a high quality directional FM antenna. Set the TUNING MODE button to the manual tuning mode. |
| | There is distortion and clear reception cannot be obtained even with a good FM antenna. | There is multipath interference. | Adjust antenna placement to eliminate multipath interference. |
| | A desired station cannot be tuned in with the automatic tuning method. | The station is too weak. | Use the manual tuning method. Use a high quality directional FM antenna. |
| | Previously preset stations can no longer be tuned in. | This unit has been unplugged for a long period. | Repeat the presetting procedure. |
| AM | A desired station cannot be tuned in with the automatic tuning method. | Weak signal or loose antenna connections. | Tighten the AM loop antenna connections and rotate it for best reception. Use the manual tuning method. |
| | There are continuous crackling and hissing noises. | Noises result from lightning, fluorescent lamps, motors, thermostats and other electrical equipment. | Use an outdoor antenna and a ground wire. This will help somewhat but it is difficult to eliminate all the noises. |
| | There are buzzing and whining noises (especially in the evening). | A television set is being used nearby. | Relocate this unit away from the TV. |
| Remote control transmitter | The remote control transmitter does not work. | Direct sunlight or lighting (of an inverter type of fluorescent lamp etc.) is striking the remote control sensor of the main unit. | Change the position of the main unit. |
| | | The batteries of this remote control transmitter are too weak. | Replace the batteries with new ones. |
| Others | The sound is degraded when listening with the headphones connected to the compact disc player or cassette deck that is connected with this unit. | This unit is in the standby mode. | Turn the power to this unit on. |

SPECIFICATIONS

AUDIO SECTION

Minimum RMS Output Power per Channel (Power Amp. Section)
8 ohms, 20 Hz to 20 kHz, 0.04% THD

<RX-496RDS/496>75 W+75 W
<RX-396RDS/396>50 W+50 W

Dynamic Power per Channel
(by IHF Dynamic Headroom measuring method)

<RX-496RDS/496>
8/6/4/2 ohms105/125/150/178 W
<RX-396RDS/396>
8/6/4/2 ohms70/77/89/100 W

DIN Standard Output Power per Channel

[Europe model only]
4 ohms, 1 kHz, 0.7% THD
<RX-496RDS>105 W
<RX-396RDS/396>55 W

IEC Power [Europe model only]

8 ohms, 1 kHz, 0.04% THD
<RX-496RDS/496>84 W
<RX-396RDS/396>52 W

Power Band Width

<RX-496RDS/496>
8 ohms, 35 W, 0.08% THD10 Hz to 50 kHz
<RX-396RDS/396>
8 ohms, 22.5 W, 0.08% THD10 Hz to 50 kHz

Damping Factor (SPEAKERS A)

8 ohms, 20 Hz to 20 kHz100 or more

Maximum Power (EIAJ) 1 kHz, 10 % THD

[General model only]
<RX-496>100 W
<RX-396>70 W

Input Sensitivity/Impedance

PHONO MM2.5 mV/47 k-ohms
CD/AUX/TAPE 1/TAPE 2150 mV/47 k-ohms

Maximum Input Signal

PHONO MM
1 kHz, 0.04% THD90 mV

Output Level/Impedance

REC OUT150 mV/2.5 k-ohms

Headphone Jack Rated Output/Impedance

Output Level (8 ohms, 0.04% THD)
<RX-496RDS/496>0.49 V/390 ohms
<RX-396RDS/396>0.47 V/330 ohms

Frequency Response (20 Hz to 20 kHz)

CD/AUX/TAPE 1/TAPE 20±0.5 dB

RIAA Equalization Deviation

PHONO MM0±0.5 dB

Total Harmonic Distortion (20 Hz to 20 kHz)

PHONO MM to REC OUT
1 V0.02 %
CD/AUX/TAPE 1/TAPE 2 to SP OUT
35 W/8 ohms0.02 %

Signal-to-Noise Ratio (IHF-A Network)

PHONO MM to REC OUT
(5 mV Input Shorted)82 dB
CD/AUX/TAPE 1/TAPE 2 to SP OUT
(Shorted)108 dB

Residual Noise (IHF-A Network)

MAIN L/R100 µV

Channel Separation (Vol. -30 dB, EFFECT OFF)

CD/AUX/TAPE 1/TAPE 2
(Input 5.1 k-ohms Terminated, 1 kHz to 10 kHz)60 dB

Tone Control Characteristics

BASS: Boost/cut±10 dB (50 Hz)
Turnover Frequency350 Hz
TREBLE: Boost/cut±10 dB (20 kHz)
Turnover Frequency3.5 kHz

Continuos LOUDNESS Control-30 dB (1 kHz)

FM SECTION

| | |
|---|-------------------------|
| Tuning Range | 87.5 to 108.0 MHz |
| 50 dB Quieting Sensitivity (IHF, 75 ohms) [General model only] | |
| Mono | 1.55 μ V (15.1 dBf) |
| Stereo | 21 μ V (37.7 dBf) |
| Usable Sensitivity (75 ohms) [General model] | |
| 30 dB S/N Quieting | 0.8 μ V (9.3 dBf) |
| [Europe and U.K. models] | |
| DIN, Mono (S/N 26 dB) | 0.9 μ V |
| DIN, Stereo (S/N 46 dB) | 24 μ V |
| Image Response Ratio | |
| [General model] | 45 dB |
| [Europe and U.K. models] | 80 dB |
| IF Response Ratio | 80 dB |
| Spurious Response Ratio | 70 dB |
| AM Suppression Ratio | 55 dB |
| Capture Ratio | 1.5 dB |
| Alternate Channel Selectivity [General model only] | 85 dB |
| Signal-to-Noise Ratio (IHF) Mono/Stereo | |
| [General model] | 80 dB/75 dB |
| (DIN-Weighted, 40 kHz Dev.) Mono/Stereo [Europe and U.K. models] | 75 dB/70 dB |
| Harmonic Distortion (1 kHz) Mono/Stereo | 0.1/0.2 % |
| Stereo Separation (1 kHz) | 50 dB |
| Frequency Response 20 Hz to 15 kHz | 0 \pm 1.5 dB |

AM SECTION

| | |
|-----------------------------|------------------|
| Tuning Range | |
| [General model] | 530 to 1,710 kHz |
| [Europe and U.K. models] | 531 to 1,611 kHz |
| Usable Sensitivity | 100 μ V/m |
| Selectivity | 32 dB |
| Signal-to-Noise Ratio | 50 dB |
| Image Response Ratio | 40 dB |
| Spurious Response Ratio | 50 dB |
| Harmonic Distortion (1 kHz) | 0.3 % |

AUDIO SECTION

| | |
|------------------------|-------------------|
| Output Level/Impedance | |
| FM (100 % mod., 1 kHz) | 500 mV/2.2 k-ohms |
| AM (30 % mod., 1 kHz) | 150 mV/2.2 k-ohms |

GENERAL

| | |
|---|--|
| Power Supply | |
| [General model] | AC 110/120/220/240 V, 50/60 Hz |
| [Europe and U.K. models] | AC 230 V, 50 Hz |
| Power Consumption | |
| <RX-496RDS/496> | 145 W |
| <RX-396RDS/396> | 120 W |
| AC Outlets | |
| 2 SWITCHED OUTLETS [Europe and General models] | 100 W max. total |
| 1 SWITCHED OUTLET [U.K. model] | 100 W max. total |
| Dimensions (W x H x D) | 435 x 146 x 308.5 mm (17-1/8" x 5-3/4" x 12-1/8") |
| Weight | |
| <RX-496RDS/496> | 8.2 kg (18 lbs. 1 oz.) |
| <RX-396RDS/396> | 6.4 kg (14 lbs. 2 oz.) |
| Accessories | AM loop antenna Indoor FM antenna 75-ohm/300-ohm antenna adapter (U.K. model only) Remote control transmitter Batteries |

Specifications are subject to change without notice.

YAMAHA

YAMAHA ELECTRONICS CORPORATION, USA 6660 ORANGETHORPE AVE., BUENA PARK, CALIF. 90620, U.S.A.
YAMAHA CANADA MUSIC LTD. 135 MILNER AVE., SCARBOROUGH, ONTARIO M1S 3R1, CANADA
YAMAHA ELECTRONIK EUROPA G.m.b.H. SIEMENSSTR. 22-34, 25462 RELLINGEN BEI HAMBURG, F.R. OF GERMANY
YAMAHA ELECTRONIQUE FRANCE S.A. RUE AMBROISE CROIZAT BP70 CROISSY-BEAUBOURG 77312 MARNE-LA-VALLEE CEDEX02, FRANCE
YAMAHA ELECTRONICS (UK) LTD. YAMAHA HOUSE, 200 RICKMANSWORTH ROAD WATFORD, HERTS WD1 7JS, ENGLAND
YAMAHA SCANDINAVIA A.B. J A WETTERGRENS GATA 1, BOX 30053, 400 43 VÄSTRA FRÖLUNDA, SWEDEN
YAMAHA MUSIC AUSTRALIA PTY, LTD. 17-33 MARKET ST., SOUTH MELBOURNE, 3205 VIC., AUSTRALIA

YAMAHA CORPORATION

V205380