



AVENTAGE

AV Receiver

*RX-A670*

Owner's Manual

musicCast

- 
- This unit is a product for enjoying video and music at home.
  - This manual explains preparations and operations for everyday users of the unit.
  - Read the supplied booklet "Quick Start Guide" before using the unit.

# CONTENTS

## BEFORE USING THE UNIT 5

<b>Accessories</b> .....	5
<b>How to use this manual</b> .....	5
<b>Remote control</b> .....	6
Insert the batteries.....	6
Operating range of the remote control.....	6

## FEATURES 7

<b>What you can do with the unit</b> .....	7
<b>Part names and functions</b> .....	11
Front panel.....	11
Front display (indicators).....	12
Rear panel.....	13
Remote control.....	14

## PREPARATIONS 15

<b>1 Placing speakers</b> .....	16
Typical speaker layouts.....	17
Other speaker layouts.....	19
Presence speaker layout.....	21
Setting the speaker impedance.....	22
<b>2 Connecting speakers</b> .....	23
Connecting speaker cables.....	24
Connecting the subwoofer (with built-in amplifier).....	24
Connecting front speakers that support bi-amp connections.....	24
Connecting Zone B speakers.....	24
<b>3 Connecting a TV/playback devices</b> .....	25
Input/output jacks and cables.....	25
Connecting a TV.....	26
Connecting video devices (such as BD/DVD players).....	27
Connecting audio devices (such as CD players).....	29
Connecting to the jack on the front panel.....	29

<b>4 Connecting the radio antennas</b> .....	30
FM/AM antennas (Except for U.K., Europe, Australia and Russia models).....	30
DAB/FM antenna (U.K., Europe, Australia and Russia models).....	30
<b>5 Preparing for connecting to a network</b> .....	31
Connecting a network cable.....	31
Preparing a wireless antenna.....	31
<b>6 Connecting the power cable</b> .....	32
<b>7 Selecting an on-screen menu language</b> .....	33
<b>8 Configuring the necessary speaker settings</b> .....	34
<b>9 Optimizing the speaker settings automatically (YPAO)</b> .....	35
Error messages.....	37
Warning messages.....	38
<b>10 Connecting to a network wirelessly</b> .....	39
Selecting the connection method.....	39
Connecting the unit to a wireless network.....	40
Connecting a mobile device to the unit directly (Wireless Direct).....	45
<b>11 Setting the MusicCast</b> .....	47
MusicCast CONTROLLER.....	47
Adding the unit to the MusicCast network.....	47

## PLAYBACK 48

<b>Basic playback procedure</b> .....	48
Enjoying playback.....	48
Switching information on the front display.....	49
<b>Selecting the input source and favorite settings with one touch (SCENE)</b> .....	50
Selecting a registered scene.....	50
Registering a scene.....	50

<b>Selecting the sound mode</b> .....	<b>51</b>
Enjoying stereoscopic sound fields (CINEMA DSP 3D).....	52
Enjoying unprocessed playback.....	54
Enjoying pure high fidelity sound (direct playback).....	55
Enhancing the bass (Extra Bass).....	55
Playing back digitally compressed formats (such as MP3, etc.) with enriched sound (Compressed Music Enhancer).....	55
<b>Listening to FM/AM radio (Except for U.K., Europe, Australia and Russia models)</b> .....	<b>56</b>
Selecting a frequency for reception.....	56
Registering favorite radio stations (presets).....	57
<b>Listening to DAB radio (U.K., Europe, Australia and Russia models)</b> .....	<b>60</b>
Preparing the DAB tuning.....	60
Selecting a DAB radio station for reception.....	61
Registering favorite DAB radio stations (presets).....	62
Displaying the DAB information.....	63
Checking reception strength of each DAB channel label.....	64
<b>Listening to FM radio (U.K., Europe, Australia and Russia models)</b> .....	<b>65</b>
Selecting a frequency for reception.....	65
Registering favorite FM radio stations (presets).....	65
Radio Data System tuning.....	68
<b>Playing back music stored on a Bluetooth® device</b> .....	<b>69</b>
Playback Bluetooth® device music on the unit.....	69
Enjoying audio using Bluetooth® speakers/headphones.....	70
<b>Playing back music with AirPlay</b> .....	<b>71</b>
Playback of iTunes/iPhone music contents.....	71
<b>Playing back music stored on a USB storage device</b> .....	<b>73</b>
Connecting a USB storage device.....	73
Playback of USB storage device contents.....	73
<b>Playing back music stored on media servers (PCs/NAS)</b> .....	<b>76</b>
Media sharing setup.....	76
Playback of PC music contents.....	77
<b>Listening to Internet radio</b> .....	<b>79</b>
Playback of Internet radio.....	79
Registering favorite Internet radio stations.....	80

<b>Playing back more high-quality sounds with bi-amp connections</b> .....	<b>81</b>
Connecting front speakers that support bi-amp connections.....	81
<b>Playing back music in multiple rooms</b> .....	<b>82</b>
Connecting Zone B speakers.....	82
Operating the Zone B.....	83
<b>Useful functions</b> .....	<b>85</b>
Registering favorite items (shortcut).....	85
<b>Configuring playback settings for different playback sources (Option menu)</b> .....	<b>87</b>
Option menu items.....	87

## **CONFIGURATIONS** **91**

<b>Configuring various functions (Setup Menu)</b> .....	<b>91</b>
Setup menu items.....	92
Speaker.....	94
HDMI.....	99
Sound.....	101
ECO.....	104
Function.....	105
Network.....	108
Bluetooth.....	110
Language.....	111
<b>Configuring the system settings (ADVANCED SETUP menu)</b> .....	<b>112</b>
ADVANCED SETUP menu items.....	112
Changing the speaker impedance setting (SP IMP.).....	112
Selecting the remote control ID (REMOTE ID).....	113
Switching the video signal type (TV FORMAT).....	113
Selecting the HDMI 4K signal format (4K MODE).....	113
DTS Format Notification Setting (DTS MODE).....	114
Restoring the default settings (INIT).....	114
Updating the firmware (UPDATE).....	114
Checking the firmware version (VERSION).....	114
<b>Updating the unit's firmware via the network</b> .....	<b>115</b>
Updating the unit's firmware immediately.....	115
Updating the unit's firmware at power off.....	115

---

<b>Frequently asked questions.....</b>	<b>117</b>
<b>Troubleshooting.....</b>	<b>119</b>
First, check the following:.....	119
Power, system and remote control.....	119
Audio.....	120
Video.....	122
FM/AM radio (AM radio feature is available except for U.K., Europe, Australia and Russia models)...	123
DAB radio (U.K., Europe, Australia and Russia models).....	123
USB and network.....	124
Bluetooth®.....	125
<b>Error indications on the front display.....</b>	<b>126</b>
<b>Glossary.....</b>	<b>127</b>
Audio information.....	127
HDMI and video information.....	128
Network information.....	129
Yamaha technologies.....	129
<b>Supported devices and file formats.....</b>	<b>130</b>
Supported devices.....	130
File formats.....	130
<b>Video signal flow.....</b>	<b>131</b>
<b>Information on HDMI.....</b>	<b>132</b>
HDMI Control.....	132
Audio Return Channel (ARC).....	134
HDMI signal compatibility.....	134
<b>Trademarks.....</b>	<b>135</b>
<b>Specifications.....</b>	<b>136</b>



# BEFORE USING THE UNIT

## Accessories

Check that the following accessories are supplied with the product.

AM antenna (except for U.K., Europe, Australia and Russia models)



FM antenna (except for U.K., Europe, Australia and Russia models)

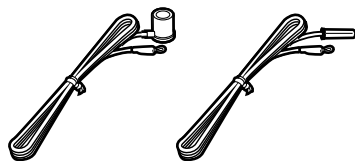

\* One of the above is supplied depending on the region of purchase.

DAB/FM antenna (U.K., Europe, Australia and Russia models)

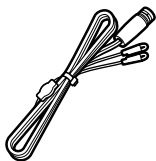

YPAO microphone

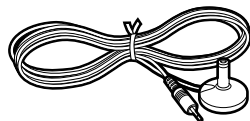

Remote control

Batteries (AAA, R03, UM-4) (x2)

CD-ROM (Owner's Manual)

Quick Start Guide

## How to use this manual

- The illustrations of the main unit used in this manual are of the U.S.A. model, unless otherwise specified.
- Some features are not available in certain regions.
- Due to product improvements, specifications and appearance are subject to change without notice.
- This manual explains operations using the supplied remote control.
- This manual describes all the "iPod touch", "iPhone" and "iPad" as the "iPhone". "iPhone" refers to "iPod touch", "iPhone" and "iPad", unless otherwise specified.

### Notice:

Indicates precautions for use to avoid the possibility of malfunction/damage to the unit.

### Note:

Indicates instructions and supplementary explanations for optimum use.

## Remote control

The supplied remote control is used as follows.

### Insert the batteries

Insert the batteries the right way round.

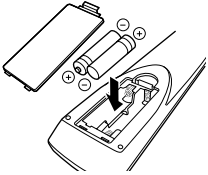

### Operating range of the remote control

Point the remote control at the remote control sensor on the unit and remain within the operating range shown below.

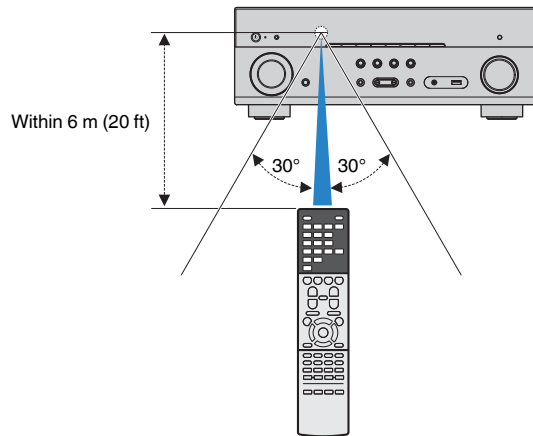

# FEATURES

## What you can do with the unit

The unit is equipped with full of useful functions.

### Supports 2- to 7.1-channel speaker system

You can enjoy your favorite acoustic spaces in various styles.

#### YPAO automatically optimizes the speaker settings to suit your room.

- “Optimizing the speaker settings automatically (YPAO)” (p.35)

#### CINEMA DSP allows you to create stereo or multichannel sounds with the sound fields like actual movie theaters and concert halls in your own room.

- “Enjoying stereoscopic sound fields (CINEMA DSP 3D)” (p.52)

#### You can enjoy compressed music with enhanced sound (Compressed Music Enhancer).

- “Playing back digitally compressed formats (such as MP3, etc.) with enriched sound (Compressed Music Enhancer)” (p.55)

#### The Zone A/B function allows you to playback an input source in the room where the unit is installed (Zone A) and in another room (Zone B).

- “Playing back music in multiple rooms” (p.82)

### Change the input source and favorite settings with one touch (SCENE)

The SCENE function allows you to select the input source and settings registered to the corresponding scene, such as sound program and Compressed Music Enhancer on/off, with just one touch.

- “Selecting the input source and favorite settings with one touch (SCENE)” (p.50)

### 4K Ultra HD signal and HDCP 2.2 supported

You can enjoy the high definition video quality of 4K with HDCP 2.2 that complies with the latest copyright protection.

- “Selecting the HDMI 4K signal format (4K MODE)” (p.113)

### Support for the Latest Surround Format, Dolby Atmos® and DTS:X™ with presence speakers

The unit supports Dolby Atmos and DTS:X that will fill the room with multidimensional sound. You can enjoy Dolby Atmos, DTS:X or CINEMA DSP 3D with the layout for presence speakers that suits your listening environment.

- “Typical speaker layouts” (p.17)
- “Presence speaker layout” (p.21)

### Wide variety of supported content via network

When the unit is connected to a network by establishing a wired or wireless connection, you can enjoy various contents via network on the unit.

#### You can select a wired or wireless connection to a network.

- “Preparing for connecting to a network” (p.31)
- “Connecting to a network wirelessly” (p.39)

#### You can play back music files stored on your PC or DLNA-compatible NAS on the unit.

- “Playing back music stored on media servers (PCs/NAS)” (p.76)

#### You can listen to Internet radio stations from all over the world.

- “Listening to Internet radio” (p.79)

#### The AirPlay function allows you to play back iTunes or iPhone/iPad/iPod touch music on the unit via network.

- “Playing back music with AirPlay” (p.71)

## **The ECO mode (power saving function) allows you to create an eco-friendly home theater system**

When the ECO mode is enabled, you can reduce the unit's power consumption.

- "ECO Mode" (p.104)

## **Sequential operation of a TV, AV receiver, and BD/DVD player (HDMI Control)**

When the unit is connected to an HDMI Control-compatible TV and BD/DVD player with each HDMI cable, you can control the unit (such as power and volume) and BD/DVD player with TV remote control operations.

- "HDMI Control" (p.132)

## **Supports Bluetooth® devices**

You can play back music stored on a Bluetooth device.

- "Playing back music stored on a Bluetooth® device" (p.69)

## **Supports USB storage devices**

You can play back music stored on a USB storage device.

- "Playing back music stored on a USB storage device" (p.73)

## **Connecting various devices**

A number of HDMI jacks and various input/output jacks on the unit allow you to connect video devices (such as BD/DVD players), audio devices (such as CD players), game consoles, portable audio player, and other devices.

- "Connecting a TV/playback devices" (p.25)

## **Playing back TV audio in surround sound with a single HDMI cable connection (Audio Return Channel: ARC)**

When using an ARC-compatible TV, you only need one HDMI cable to enable video output to the TV, audio input from the TV, and the transmission of HDMI Control signals.

- "Connecting a TV" (p.26)

## **Creating 3-dimensional sound fields**

Connecting presence speakers allows you to create a natural 3-dimensional sound field in your own room (CINEMA DSP 3D). Even when no presence speakers are connected, the Virtual Presence Speaker (VPS) function produces 3D surround sound. In addition, the unit creates Virtual Surround Back Speaker (VSBS) using the surround speakers to add a sense of depth to the rear sound field even when no surround back speakers are connected.

- "Enjoying stereoscopic sound fields (CINEMA DSP 3D)" (p.52)

## **Surround playback with 5 speakers placed in front**

You can enjoy the surround sound even when the surround speakers are placed in front.

- "Enjoying surround sound with 5 speakers placed in front (Virtual CINEMA FRONT)" (p.53)

## **Enjoying pure high fidelity sound**

When the direct playback mode is enabled, the unit plays back the selected source with the least circuitry, which lets you to enjoy Hi-Fi sound quality.

- "Enjoying pure high fidelity sound (direct playback)" (p.55)

## **Enhanced bass reproduction**

Extra Bass allows you to enjoy enhanced bass reproduction that does not depend on the speakers used.

- "Enhancing the bass (Extra Bass)" (p.55)

## **Listening to FM/AM radio (Except for U.K., Europe, Australia and Russia models)**

The unit is equipped with a built-in FM/AM tuner. You can register up to 40 favorite radio stations as presets.

- "Listening to FM/AM radio (Except for U.K., Europe, Australia and Russia models)" (p.56)

## Listening to DAB/FM radio (U.K., Europe, Australia and Russia models)

The unit is equipped with a built-in DAB/FM tuner. DAB (Digital Audio Broadcasting) uses digital signals for clearer sound and more stable reception compared to analog signals. You can register up to 40 favorite radio stations as presets.

- “Listening to DAB radio (U.K., Europe, Australia and Russia models)” (p.60)
- “Listening to FM radio (U.K., Europe, Australia and Russia models)” (p.65)

## Easy operation with a TV screen

You can operate the USB storage device, view information, or easily configure the settings using the on-screen menu.

## Auto Rename function

The unit automatically creates input source names according to the HDMI-compatible devices connected, and displays the respective input source names on the front display.

- “Input Rename” (p.105)

## Useful applications

The useful application for connections and operations of the unit is as follows.

### Application for tablets “AV SETUP GUIDE”



AV SETUP GUIDE is an application that assists you with cable connections between AV Receiver and source devices as well as AV Receiver setup. This app guides you through the various settings such as speaker connections, TV and source device connections and assigning the power amp.

Functions:

- 1) Connection support guide
  - Speaker connection
  - TV/source devices connection
- 2) Setup support guide
  - Automatic network setup of HDMI, power amp assign, etc.
  - Various setup assistance with illustrations.
  - YPAO setting guidance
- 3) View Owner's Manual

\* This application is for tablets only.

For details, search for “AV SETUP GUIDE” on the App Store or Google Play™.

### Application for smartphone / tablets “AV CONTROLLER”



AV CONTROLLER is an application that assists you with various operations of AV Receiver without the remote control. This app allows you not only to control the unit's power and volume but also to select the input source and start/stop playback, as shown below.

Functions:

- Power on/off
- Volume up/down
- Mute
- Music Play
- Input Selection
- DSP Mode Selection
- SCENE selection
- Blu-ray player fundamental control
- Seamless control between the Yamaha AV Receiver and Blu-ray player
- Demo mode - Explains how to use this app

For details, search for “AV CONTROLLER” on the App Store or Google Play.

## ■ Application for smartphone / tablets "MusicCast CONTROLLER"



MusicCast CONTROLLER is an application that allows you to link a MusicCast compatible device to other MusicCast compatible devices in other rooms and play them back simultaneously. This app lets you use your smartphone or other mobile device instead of the remote control to easily select music to play back as well as configure the unit and MusicCast compatible devices.

Functions:

- Selecting and playing back various content
  - Play back music from your mobile device
  - Select an Internet radio station
  - Play back music files stored on media servers (PCs/NAS)
  - Play back music files stored on a USB storage device
- Operating and configuring the unit
  - Select the input source, adjust the volume and mute the audio output
  - Select from a wide variety of sound processing features

For details, search for "MusicCast CONTROLLER" on the App Store or Google Play.

## Part names and functions

The part names and functions of the unit and the supplied remote control are as follows.

### Front panel

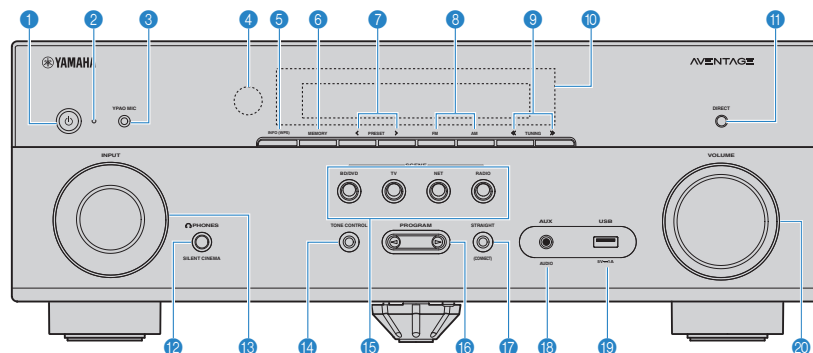

(U.S.A. model)

- 1** **⏻ (power) key**  
Turns on/off (standby) the unit.
- 2** **Standby indicator**  
Lights up when the unit is in standby mode under any of the following conditions.
  - HDMI Control is enabled (p.99)
  - Standby Through is enabled (p.99)
  - Network Standby is enabled (p.109)
- 3** **YPAO MIC jack**  
For connecting the supplied YPAO microphone (p.35).
- 4** **Remote control sensor**  
Receives remote control signals (p.6).
- 5** **INFO (WPS) key**  
Selects the information displayed on the front display (p.49).  
Enters the wireless LAN connection setup (WPS button configuration) by holding down for 3 seconds (p.41).
- 6** **MEMORY key**  
Registers radio stations as preset stations (p.57).
- 7** **PRESET keys**  
Select a preset radio station (p.58).
- 8** **FM and AM keys (except for U.K., Europe, Australia and Russia models)**  
**FM and DAB keys (U.K., Europe, Australia and Russia models)**  
Switch between FM and AM (p.56) or FM and DAB (p.60).
- 9** **TUNING keys**  
Select the radio frequency (p.56).
- 10** **Front display**  
Displays information (p.12).
- 11** **DIRECT key**  
Enables/disables the direct playback mode (p.55).
- 12** **PHONES jack**  
For connecting headphones.
- 13** **INPUT knob**  
Select an input source.
- 14** **TONE CONTROL key**  
Adjusts the level of high-frequency range (Treble) and low-frequency range (Bass) individually (p.88).
- 15** **SCENE keys**  
Select the registered input source and sound program with one touch. Also, turns on the unit when it is in standby mode (p.50).
- 16** **PROGRAM keys**  
Select a sound program or a surround decoder (p.51).
- 17** **STRAIGHT (CONNECT) key**  
Enables/disables the straight decode mode (p.54).  
Enters the MusicCast network addition and the wireless LAN setup by holding down for 5 seconds (p.47).
- 18** **AUX jack**  
For connecting devices, such as portable audio players (p.29).
- 19** **USB jack**  
For connecting a USB storage device (p.73).
- 20** **VOLUME knob**  
Adjusts the volume.

## Front display (indicators)

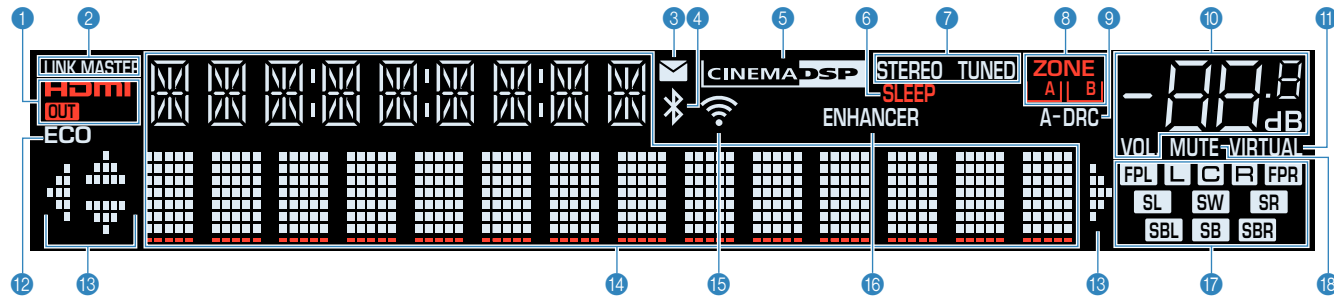

### 1 HDMI

Lights up when HDMI signals are being input or output.

#### OUT

Lights up when HDMI signals are being output.

### 2 LINK MASTER

Lights up when the unit is the master device of the MusicCast network.

### 3 Firmware update indicator

Lights up when a firmware update is available via the network.

### 4 Bluetooth indicator

Light up while the unit is connected to a Bluetooth device.

### 5 CINEMA DSP

Lights up when CINEMA DSP (p.52) or CINEMA DSP 3D (p.52) is working.

### 6 SLEEP

Lights up when the sleep timer is on.

### 7 STEREO

Lights up when the unit is receiving a stereo FM radio signal.

#### TUNED

Lights up when the unit is receiving an FM/AM radio station (except for U.K., Europe, Australia and Russia models) or FM radio station (U.K., Europe, Australia and Russia models) signal.

### 8 ZONE indicators

Indicate the zone to which the sound is output (p.84).

### 9 A-DRC

Lights up when Adaptive DRC (p.88) is working.

### 10 Volume indicator

Indicates the current volume.

### 11 VIRTUAL

Lights up when the Virtual Surround Back Speaker (VSBS) (p.17), Virtual Presence Speaker (VPS) (p.52), Virtual CINEMA DSP (p.53) or Virtual CINEMA FRONT (p.53) is working.

### 12 ECO

Lights up when the eco mode (p.104) is enabled.

### 13 Cursor indicators

Indicate the remote control cursor keys currently operational.

### 14 Information display

Displays the current status (such as input name and sound mode name). You can switch the information by pressing INFO (p.49).

### 15 Signal strength indicator

Indicates the strength of the wireless signal (p.39).

#### Note

This indicator may light up when the unit is added to the MusicCast network. For details, see "Setting the MusicCast" (p.47).

### 16 ENHANCER

Lights up when Compressed Music Enhancer (p.55) is working.

### 17 Speaker indicators

Indicate speaker terminals from which signals are output.

**L** Front speaker (L)

**R** Front speaker (R)

**C** Center speaker

**SL** Surround speaker (L)

**SR** Surround speaker (R)

**SBL** Surround back speaker (L)

**SBR** Surround back speaker (R)

**SB** Surround back speaker

**FPL** Presence speaker (L)

**FPR** Presence speaker (R)

**SW** Subwoofer

### 18 MUTE

Blinks when audio is temporarily muted.



# Rear panel

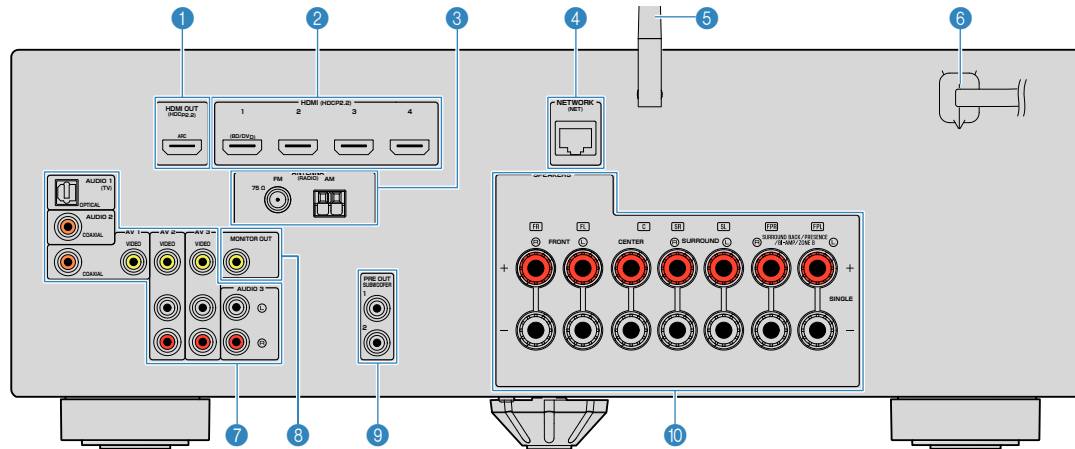

• The area around the video/audio output jacks is marked in white on the actual product to prevent improper connections.

## 1 HDMI OUT jack

For connecting to an HDMI-compatible TV and outputting video/audio signals (p.25). When using ARC, TV audio signal can also be input through the HDMI OUT jack.

## 2 HDMI 1-4 jacks

For connecting to HDMI-compatible playback devices and inputting video/audio signals (p.27).

## 3 ANTENNA jacks

For connecting to the radio antennas (p.30).

## 4 NETWORK jack

For a wired connection to a network (p.31).

## 5 Wireless antenna

For a wireless (Wi-Fi) connection to a network (p.31) and a Bluetooth connection (p.69).

## 6 Power cable

For connecting to an AC wall outlet (p.32).

## 7 AV jacks

### AUDIO jacks

For connecting to video/audio playback devices and inputting video/audio signals (p.27).

## 8 MONITOR OUT jack

For connecting to a TV and outputting video signals (p.25).

## 9 SUBWOOFER PRE OUT 1-2 jacks

For connecting to a subwoofer (with built-in amplifier) (p.23).

## 10 SPEAKERS terminals

For connecting to speakers (p.23).

( U.S.A. model)

# Remote control

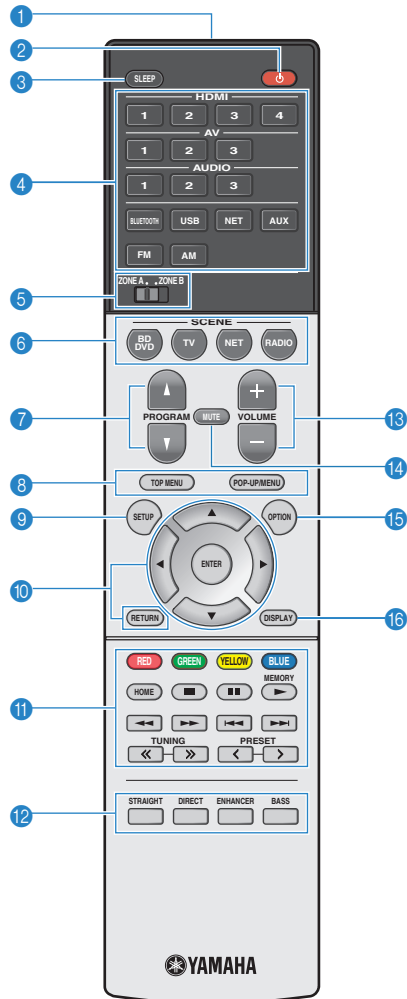

(U.S.A. model)

## 1 Remote control signal transmitter

Transmits infrared signals.

## 2 (receiver power) key

Turns on/off (standby) the unit.

## 3 SLEEP key

Pressing this key repeatedly will specify the time (120 min, 90 min, 60 min, 30 min, off), in which the unit switches to the standby mode.

## 4 Input selection keys

Select an input source for playback.

You can select directly each input source by pressing the following keys.

**HDMI 1-4** HDMI 1-4 jacks

**AV 1-3** AV 1-3 jacks

**AUDIO 1-3** AUDIO 1-3 jacks

**BLUETOOTH** Bluetooth device

**USB** USB jack (on the front panel)

**NET** SERVER, NET RADIO, MusicCast Link, AirPlay and network sources (press repeatedly to select a desired source)

**AUX** AUX jack (on the front panel)

**FM** FM radio

**AM or DAB** AM radio (except for U.K., Europe, Australia and Russia models) or DAB radio (U.K., Europe, Australia and Russia models)

## 5 ZONE switch

Changes the zone that is controlled by the remote control (p.83).

## 6 SCENE keys

Select the registered input source and sound program with one touch. Also, turn on the unit when it is in standby mode (p.50).

## 7 PROGRAM keys

Select a sound program or a surround decoder (p.51).

## 9 SETUP key

Displays the setup menu (p.91).

## 10 Menu operation keys

**Cursor keys** Select a menu or the parameter.

**ENTER** Confirms a selected item.

**RETURN** Returns to the previous screen.

## 8 10 11 External device operation keys

Let you perform playback operations when "USB" or "NET" is selected as the input source, or control playback of the HDMI Control-compatible playback device.

### Note

- The playback devices must support HDMI Control. Some HDMI Control-compatible devices cannot be used.
- You can assign the unit's functions to the RED/GREEN/YELLOW/BLUE keys (p.107).

## 11 Radio keys

Operate the FM/AM/DAB radio when "TUNER" is selected as the input source (p.56).

**MEMORY** Registers radio stations as presets.

**PRESET** Select a preset station.

**TUNING** Select the radio frequency.

## 12 Sound mode keys

Select a sound mode (p.51).

## 13 VOLUME keys

Adjust the volume.

## 14 MUTE key

Mutes the audio output.

## 15 OPTION key

Displays the option menu (p.87).

## 16 DISPLAY key

Turns on/off the browse screen, playback screen, etc.

# PREPARATIONS

## General setup procedure

- 1** **Placing speakers..... (p.16)**
- 2** **Connecting speakers..... (p.23)**
- 3** **Connecting a TV/playback devices..... (p.25)**
- 4** **Connecting the radio antennas..... (p.30)**
- 5** **Preparing for connecting to a network..... (p.31)**
- 6** **Connecting the power cable..... (p.32)**
- 7** **Selecting an on-screen menu language..... (p.33)**
- 8** **Configuring the necessary speaker settings..... (p.34)**
- 9** **Optimizing the speaker settings automatically (YPAO)..... (p.35)**
- 10** **Connecting to a network wirelessly..... (p.39)**
- 11** **Setting the MusicCast..... (p.47)**

This completes all the preparations. Enjoy playing movies, music, radio and other content with the unit!

# 1 Placing speakers

Select the speaker layout for the number of speakers that you are using and place the speakers and subwoofer in your room. This section describes the representative speaker layout examples.

## Notice

- (U.S.A. and Canada models only)  
Under its default settings, the unit is configured for 8-ohm speakers. When connecting 6-ohm speakers, set the unit's speaker impedance to "6  $\Omega$  MIN". For details, see "Setting the speaker impedance" (p.22).
- (Except for U.S.A. and Canada models)  
Use speakers with an impedance of at least 6  $\Omega$ .
- Use a subwoofer with built-in amplifier.
- Be sure to connect the front left and right speakers.

# Typical speaker layouts

## 5.1.2-channel system (using presence speakers)

This speaker system uses the presence speakers to produce a natural 3-dimensional sound field, and also creates Virtual Surround Back Speaker (VSBS) using the surround speakers to add a sense of depth to the rear sound field. This system is suited for enjoying not only 5.1-channel but also for 7.1-channel contents.

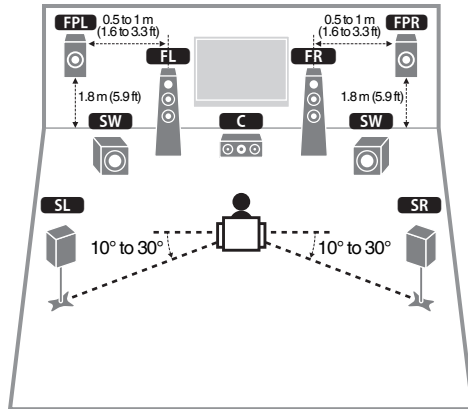

Speaker type	Abbr.	Function
Front (L/R)	<b>FL</b> / <b>FR</b>	Produce front left/right channel sounds (stereo sounds).
Center	<b>C</b>	Produces center channel sounds (such as movie dialogue and vocals).
Surround (L/R)	<b>SL</b> / <b>SR</b>	Produce surround left/right channel sounds.
Presence (L/R)	<b>FPL</b> / <b>FPR</b>	Produce CINEMA DSP effect sounds or heights channel sounds of Dolby Atmos and DTS:X contents.
Subwoofer	<b>SW</b>	Produces LFE (low-frequency effect) channel sounds and reinforces the bass parts of other channels. This channel is counted as "0.1". You can connect two subwoofers to the unit and place them on the left/right (or front/rear) sides of the room.

### Note

- "5.1.2-channel" denotes "standard 5.1-channel plus 2 for overhead speaker channels". For details on how to place overhead speakers (presence speakers), see "Presence speaker layout" (p.21).
- To have a full effect of Dolby Atmos contents, we recommend using this speaker system. However, you can also play back Dolby Atmos contents with the 7.1 system (using surround back speakers).
- To have a full effect of DTS:X contents, we recommend using this speaker system.
- You can connect two subwoofers (with built-in amplifier) to the unit. Two subwoofers connected to the unit output the same sounds.
- When using only one subwoofer, you can place it either in the left or right side.

## 7.1-channel system

This speaker system creates Virtual Presence Speaker (VPS) using the front, center and surround speakers to produce a 3-dimensional sound field, and also allows you to enjoy extended surround sounds using the surround back speakers.

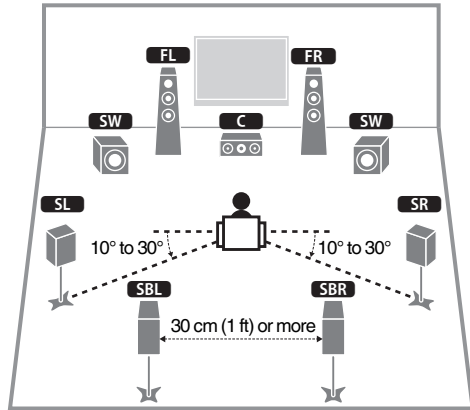

Speaker type	Abbr.	Function
Front (L/R)	<b>FL</b> / <b>FR</b>	Produce front left/right channel sounds (stereo sounds).
Center	<b>C</b>	Produces center channel sounds (such as movie dialogue and vocals).
Surround (L/R)	<b>SL</b> / <b>SR</b>	Produce surround left/right channel sounds.
Surround back (L/R)	<b>SBL</b> / <b>SBR</b>	Produce surround back left/right channel sounds.
Subwoofer	<b>SW</b>	Produces LFE (low-frequency effect) channel sounds and reinforces the bass parts of other channels. This channel is counted as "0.1". You can connect two subwoofers to the unit and place them on the left/right (or front/rear) sides of the room.

### Note

- When using only one surround back speaker (6.1-channel system), place it straight behind the listening position (middle of **SBL** and **SBR** in the diagram).
- You can connect two subwoofers (with built-in amplifier) to the unit. Two subwoofers connected to the unit output the same sounds.
- When using only one subwoofer, you can place it either in the left or right side.

## Other speaker layouts

The following speaker layouts are also available.

### ■ 5.1-channel system

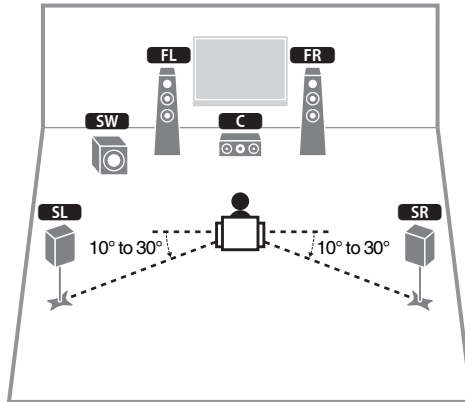

#### Note

- You can enjoy surround sound even without the center speaker (4.1-channel system).
- In addition to this speaker layout, you can use bi-amp connections or the Zone B function that allows you to play back an input source in another room (Zone B). For details, see "Playing back more high-quality sounds with bi-amp connections" (p.81) or "Playing back music in multiple rooms" (p.82).

### ■ 5.1 system (front 5.1-channel) (using surround speakers)

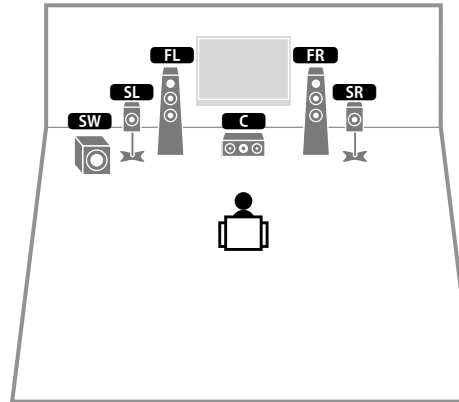

#### Note

- To utilize this configuration, set "Virtual CINEMA FRONT" (p.97) in the "Setup" menu to "On".
- You can enjoy surround sound even without the center speaker (front 4.1-channel system).
- In addition to this speaker layout, you can use bi-amp connections or the Zone B function that allows you to play back an input source in another room (Zone B). For details, see "Playing back more high-quality sounds with bi-amp connections" (p.81) or "Playing back music in multiple rooms" (p.82).

### ■ 3.1.2 system

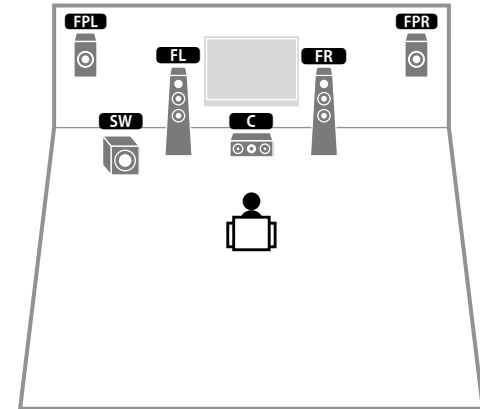

#### Note

You can also play back Dolby Atmos and DTS:X contents with this speaker system.

### ■ 3.1-channel system

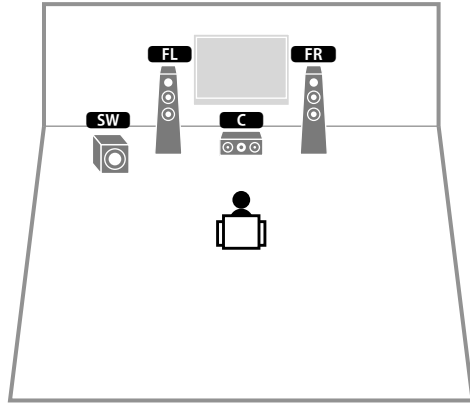

#### Note

In addition to this speaker layout, you can use bi-amp connections or the Zone B function that allows you to play back an input source in another room (Zone B). For details, see "Playing back more high-quality sounds with bi-amp connections" (p.81) or "Playing back music in multiple rooms" (p.82).

### ■ 2.1-channel system

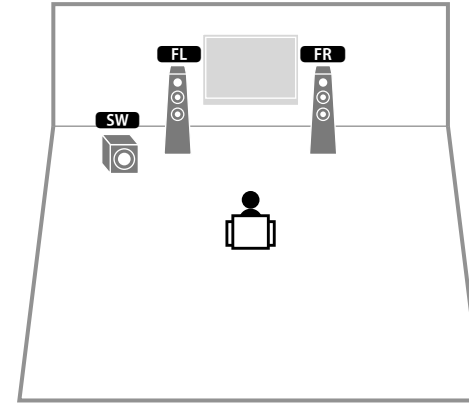

#### Note

In addition to this speaker layout, you can use bi-amp connections or the Zone B function that allows you to play back an input source in another room (Zone B). For details, see "Playing back more high-quality sounds with bi-amp connections" (p.81) or "Playing back music in multiple rooms" (p.82).



## Presence speaker layout

The unit provides three layout patterns for presence speakers (Front Height, Overhead and Dolby Enabled SP). Choose a layout pattern that suits your listening environment.

### Note

- You can enjoy Dolby Atmos, DTS:X or Cinema DSP 3D with any layout pattern.
- When using presence speakers installed to the ceiling or when using the Dolby Enabled speakers as the presence speakers, configure the "Layout" setting in the "Setup" menu before performing YPAO (p.35).

## Front Height

Install the presence speakers on the front wall.

It delivers a natural sound field with excellent linkage of left, right, top and bottom sound spaces, and sound extensity effectively.

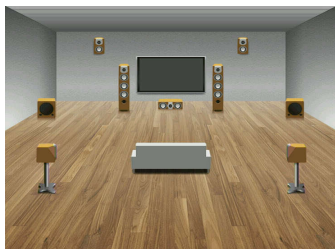

## Overhead

Install the presence speakers to the ceiling above the listening position.

It delivers realistic overhead sound effects and sound field with excellent linkage of front and rear sound spaces effectively.

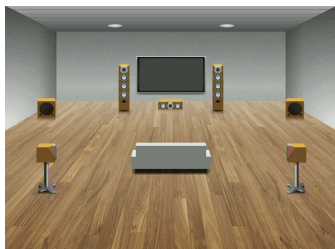

## Dolby Enabled SP

Use the Dolby Enabled speakers as the presence speakers.

This utilizes sounds reflected from ceiling and lets you enjoy overhead sounds only from speakers that are placed at the same level as traditional speakers.

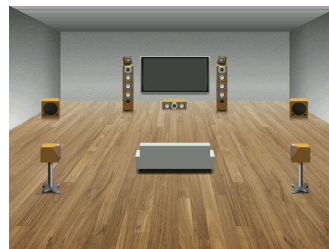

### Note

Place the Dolby Enabled speakers on top of or near the traditional front speakers. A Dolby Enabled speaker unit may be integrated into a traditional speaker. For details, refer to the instruction manual of the Dolby Enabled speakers.

## Notes on installation of ceiling speakers

When installing presence speakers to a ceiling, install them just above the listening position, or the ceiling between the extensions of the front speakers and listening position.

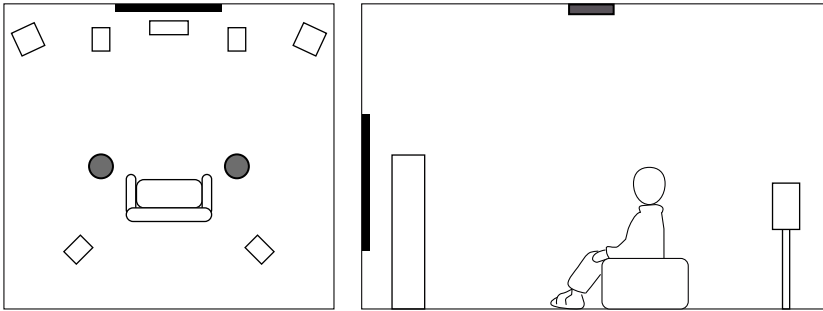

### Notice

- Be sure to use speakers that are made for ceiling use and take anti-drop measures. Ask a qualified contractor or dealer personnel for installation works.

## Setting the speaker impedance

(U.S.A. and Canada models only)

Under its default settings, the unit is configured for 8-ohm speakers. When connecting 6-ohm speakers, set the speaker impedance to "6 Ω MIN".

- 1 Before connecting speakers, connect the power cable to an AC wall outlet.
- 2 While holding down STRAIGHT on the front panel, press  (power).

 (power)

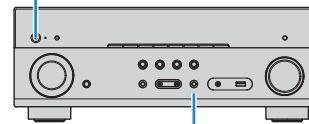

STRAIGHT

- 3 Check that "SP IMP." is displayed on the front display.



SP IMP. 8ΩMIN

- 4 Press STRAIGHT to select "6 Ω MIN".
- 5 Press  (power) to set the unit to standby mode and remove the power cable from the AC wall outlet.

You are now ready to connect the speakers.

## 2 Connecting speakers

Connect the speakers placed in your room to the unit. The following diagrams provide connections for 5.1- and 7.1-channel system as an example. For other systems, connect speakers while referring to the connection diagram for the 5.1-channel system.

### Notice

- Remove the unit's power cable from an AC wall outlet and turn off the subwoofer before connecting the speakers.
- The speaker has the polarity (+/-). Connect the speaker cable correctly between the positive (+) terminal of the unit and the speaker, and also between the negative (-) terminal of them.

### Cables required for connection (commercially available)

Speaker cables (x the number of speakers)



Audio pin cable (x1: for connecting a subwoofer)

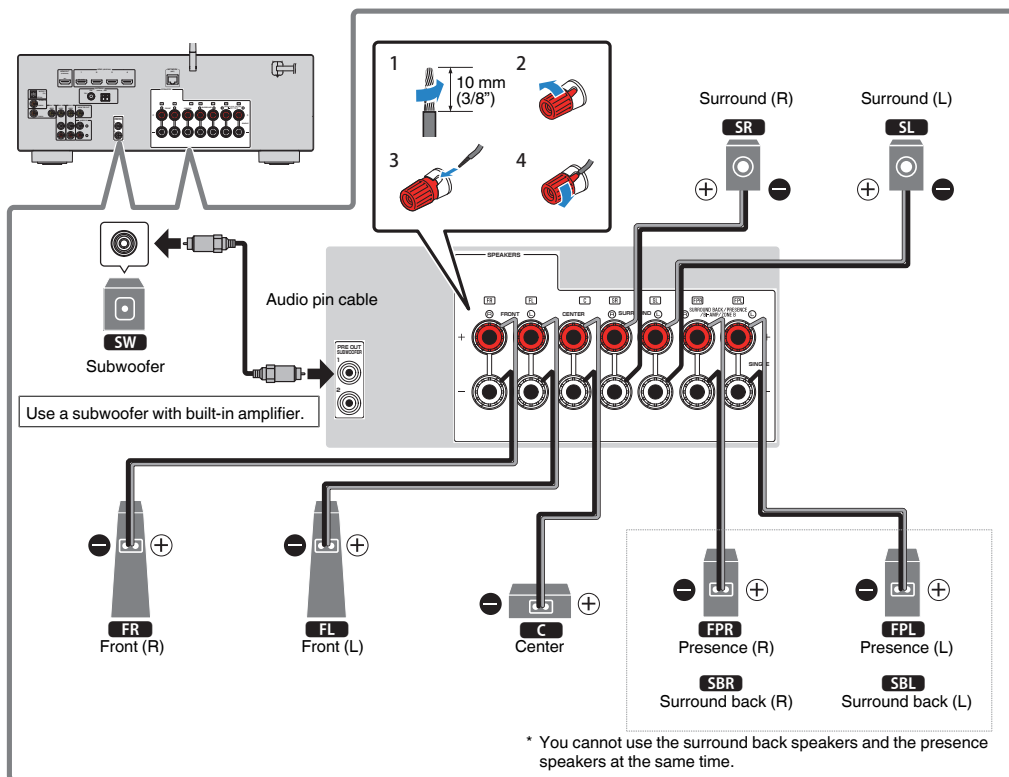

### Precaution for connecting of the speaker cables

- Prepare speaker cables in a place away from the unit, to avoid accidentally dropping wire strands into the unit's interior which could result in a short circuit or malfunction of the unit.

- Improper connecting of the speaker cables may cause short circuit and also damage the unit or the speakers.

- Twist the bare wires of the speaker cables firmly together.

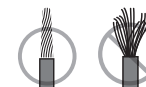

- Do not let the bare wires of the speaker cable touch one another.

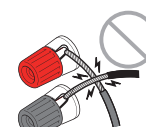

- Do not let the bare wires of the speaker cable come into contact with the unit's metal parts (rear panel and screws).

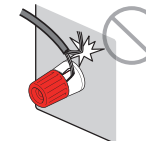

- If "Check SP Wires" appear on the front display when the unit is turned on, turn off the unit, and then check the speaker cables short circuit.

## Connecting speaker cables

Speaker cables have two wires. One is for connecting the negative (-) terminals of the unit and the speaker to each other, and the other is for the positive (+) terminals. If the wires are colored to prevent confusion, connect the black wire to the negative and the other wire to the positive terminal.

- 1 Remove approximately 10 mm (3/8") of insulation from the ends of the speaker cable, and twist the bare wires of the cable firmly together.**
- 2 Loosen the speaker terminal.**
- 3 Insert the bare wires of the cable into the gap on the side (upper right or bottom left) of the terminal.**
- 4 Tighten the terminal.**

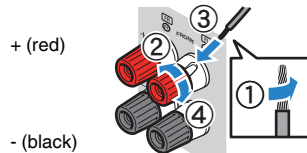

### Using a banana plug

(U.S.A. and Canada models only)

- 1 Tighten the speaker terminal.**
- 2 Insert a banana plug into the end of the terminal.**

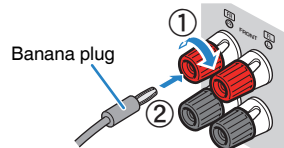

## Connecting the subwoofer (with built-in amplifier)

Use an audio pin cable to connect the subwoofer.

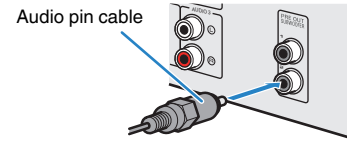

## Connecting front speakers that support bi-amp connections

When using front speakers that support bi-amp connections, connect them to the FRONT terminals and SURROUND BACK/PRESENCE/BI-AMP/ZONE B terminals. For details, see "Playing back more high-quality sounds with bi-amp connections" (p.81).

### Note

Surround back speakers, presence speakers, bi-amp speakers or Zone B speakers cannot be connected simultaneously.

## Connecting Zone B speakers

The Zone A/B function allows you to playback an input source in the room where the unit is installed (Zone A) and in another room (Zone B). To connect the Zone B speakers, see "Playing back music in multiple rooms" (p.82).

### Note

Surround back speakers, presence speakers, bi-amp speakers or Zone B speakers cannot be connected simultaneously.

## 3 Connecting a TV/playback devices

The unit is equipped with a variety of input jacks including HDMI input jacks to allow you to connect different types of playback devices. For information on how to connect a Bluetooth device or a USB storage device, see the following pages.

- Connecting a Bluetooth device (p.69)
- Connecting a USB storage device (p.73)

### Input/output jacks and cables

#### Video/audio jacks

##### HDMI jacks

Transmit digital video and digital sound through a single jack. Use an HDMI cable.

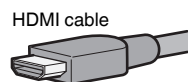

##### Note

- Use a 19-pin HDMI cable with the HDMI logo. We recommend using a cable less than 5.0 m (16.4 ft) long to prevent signal quality degradation.
- The unit's HDMI jacks support the HDMI Control, Audio Return Channel (ARC), and 3D and 4K Ultra HD video transmission (through output) features.
- Use a Premium High Speed HDMI Cable or Premium High Speed Cable with Ethernet to enjoy 3D or 4K Ultra HD videos.

#### Video jacks

##### VIDEO jacks

Transmit analog video signals. Use a video pin cable.

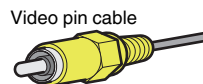

#### Audio jacks

##### OPTICAL jack

Transmit digital audio signals. Use a digital optical cable. If there is a protective cap on the tip of the cable, remove it before using the cable.



##### COAXIAL jacks

Transmit digital audio signals. Use a digital coaxial cable.



#### AUDIO jacks

##### (Stereo L/R jacks)

Transmit analog stereo audio signals. Use a stereo pin cable (RCA cable).

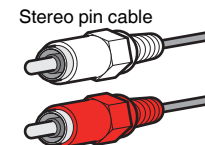

##### (Stereo mini jack)

Transmits analog stereo audio signals. Use a stereo mini-plug cable.



## Connecting a TV

Connect a TV to the unit so that video input to the unit can be output to the TV. You can also enjoy playback of TV audio on the unit.

To maximize the performance of the unit, we recommend connecting a TV with an HDMI cable.

### HDMI connection

Connect the TV to the unit with an HDMI cable and a digital optical cable.

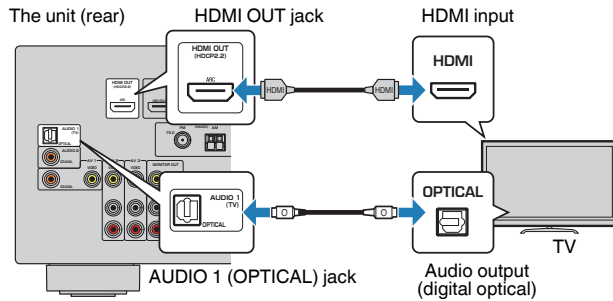

#### Note

- A digital optical cable connection allows audio from the TV to be played back on the unit. A digital optical cable connection is not needed in the following cases:
  - If your TV supports Audio Return Channel (ARC)
  - If you will receive TV broadcasts only from the set-top box
- If you connect a TV that supports HDMI Control to the unit with an HDMI cable, you can control the unit's power and volume with the TV's remote control.

To use HDMI Control and ARC, you need to configure the HDMI settings on the unit. For details on the settings, see "Information on HDMI" (p.132).

#### About Audio Return Channel (ARC)

- ARC allows audio signals to travel both ways. If you connect a TV that supports ARC to the unit with a single HDMI cable, you can output video/audio to the TV or input TV audio to the unit.
- When using ARC, connect a TV with an HDMI cable that supports ARC.

### Composite video connection

When connecting any video device with a video pin cable, connect the TV to the MONITOR OUT (VIDEO) jack.

#### Note

- If you connect your TV to the unit with a cable other than HDMI, video input to the unit via HDMI cannot be output to the TV.
- Operations with TV screen are available only when your TV is connected to the unit via HDMI.
- If you will receive TV broadcasts only from the set-top box, you do not need to make an audio cable connection between the TV and the unit.

### VIDEO (composite video) connection

Connect the TV to the unit with a video pin cable and a digital optical cable.

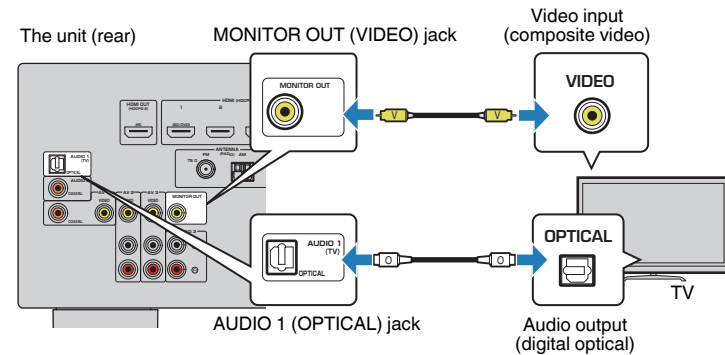

## Connecting video devices (such as BD/DVD players)

Connect video devices such as BD/DVD players, set-top boxes (STBs) and game consoles to the unit. Depending on the video/audio output jacks available on your video device, choose one of the following connections. We recommend using an HDMI connection if the video device has an HDMI output jack.

### Note

If the combination of video/audio input jacks available on the unit does not match your video device, change its combination according to the output jacks of your device (p.28).

## HDMI connection

Connect a video device to the unit with an HDMI cable.

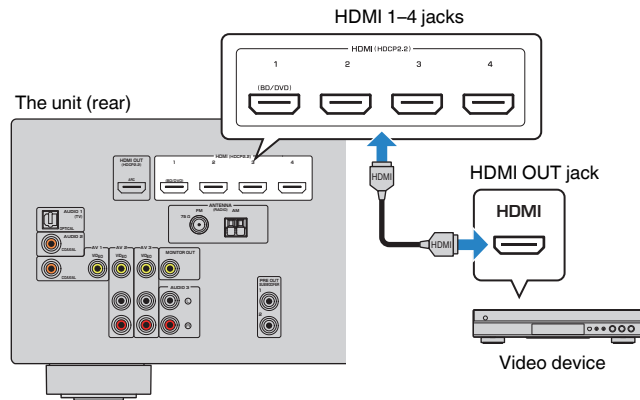

### Note

To watch videos input to the HDMI 1-4 jacks, you need to connect your TV to the HDMI OUT jack of the unit (p.26).

## Composite video connection

Connect a video device to the unit with a video pin cable and an audio cable (digital coaxial or stereo pin cable). Choose a set of input jacks (on the unit) depending on the audio output jacks available on your video device.

Output jacks on video device		Input jacks on the unit
Video	Audio	
Composite video	Digital coaxial	AV 1 (VIDEO + COAXIAL)
	Analog stereo	AV 2-3 (VIDEO + AUDIO)
	Digital optical	You need to change the combination of video/audio input jacks (p.28).

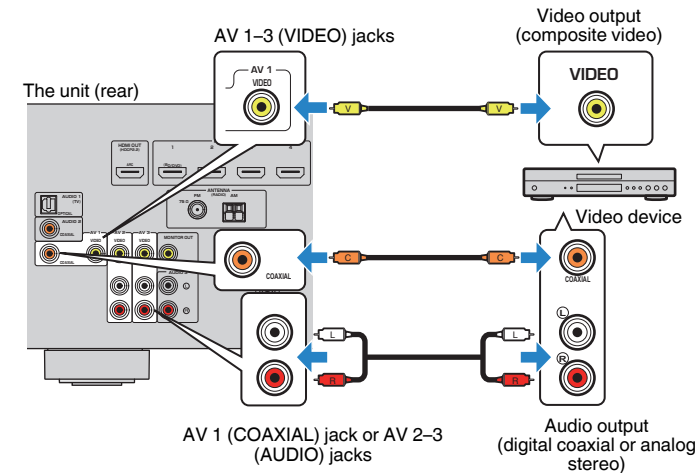

### Note

If you connect a video device to the unit via composite video connection, you need to connect your TV to the MONITOR OUT (VIDEO) jack of the unit (p.26).

## ■ Changing the combination of video/audio input jacks

If the combination of video/audio input jacks available on the unit does not match your video device, change its combination according to the output jacks of your device. You can connect a video device that has the following video/audio output jacks.

Output jacks on video device		Input jacks on the unit	
Video	Audio	Video	Audio
HDMI	Digital optical	HDMI 1-4	AUDIO 1 (OPTICAL)
	Digital coaxial	HDMI 1-4	AUDIO 2 (COAXIAL) AV 1 (COAXIAL)
	Analog stereo	HDMI 1-4	AUDIO 3 (AUDIO) AV 2-3 (AUDIO)
Composite video	Digital optical	AV 1-3 (VIDEO)	AUDIO 1 (OPTICAL)

### Necessary setting

For example, if you have connected a video device to AV 2 (VIDEO) and AUDIO 1 (OPTICAL) jack of the unit, change the combination setting as follows.

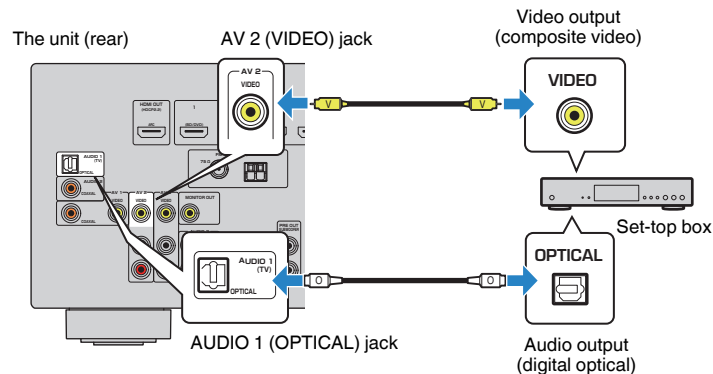

- 1 After connecting external devices (such as a TV and playback devices) and power cable of the unit, turn on the unit.
- 2 Press INPUT to select “AV 2” (video input jack to be used) as the input source.

- 3 Press OPTION.

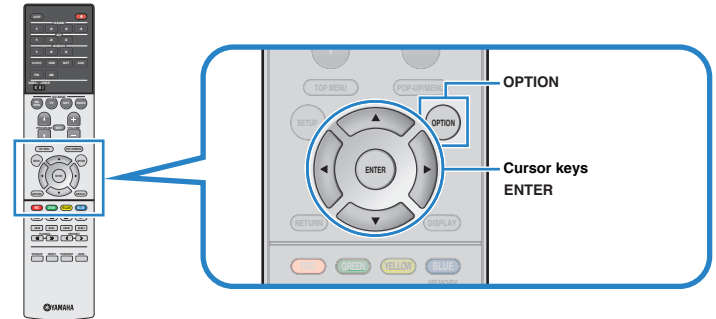

- 4 Use the cursor keys ( $\Delta/\nabla$ ) to select “Audio In” and press ENTER.



- 5 Use the cursor keys ( $\leftarrow/\rightarrow$ ) to select “AUDIO 1” (audio input jack to be used).



- 6 Press OPTION.

This completes the necessary settings.

If you select “AV 2” as the input source by pressing INPUT, the video/audio played back on the video device will be output from the unit.



## Connecting audio devices (such as CD players)

Connect audio devices such as CD players and MD players to the unit. Depending on the audio output jacks available on your audio device, choose one of the following connections.

Audio output jacks on audio device	Audio input jacks on the unit
Digital optical	AUDIO 1 (OPTICAL)
Digital coaxial	AUDIO 2 (COAXIAL) AV 1 (COAXIAL)
Analog stereo	AUDIO 3 (AUDIO) AV 2-3 (AUDIO)

The unit (rear)

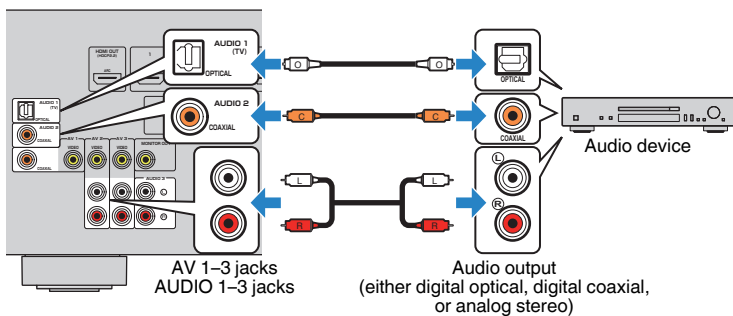

## Connecting to the jack on the front panel

Use the AUX jack on the front panel to temporarily connect devices such as portable audio players to the unit.

Before making a connection, stop playback on the device and turn down the volume on the unit.

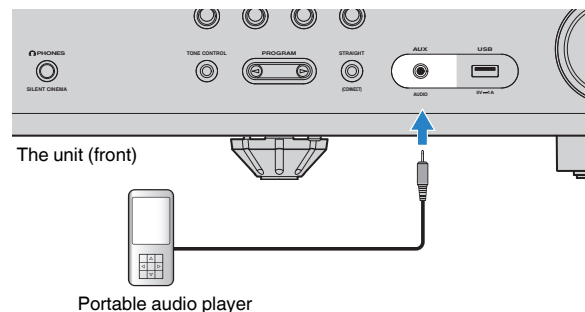

If you select "AUX" as the input source by pressing AUX, the audio played back on the device will be output from the unit.

### Note

- You need to prepare the audio cable that matches the output jacks on your device.
- For details on how to connect a USB storage device, see "Connecting a USB storage device" (p.73).

## 4 Connecting the radio antennas

### FM/AM antennas (Except for U.K., Europe, Australia and Russia models)

Connect the supplied FM/AM antennas to the unit.

Fix the end of the FM antenna to a wall, and place the AM antenna on a flat surface.

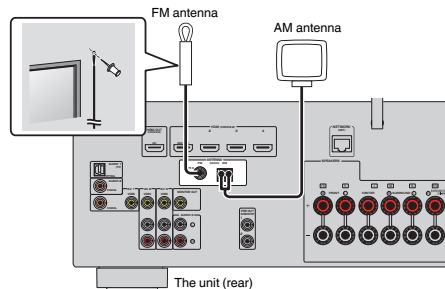

### Assembling and connecting the AM antenna

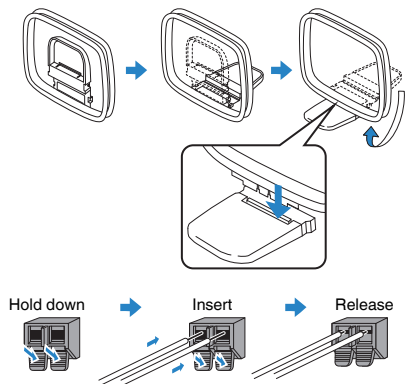

#### Note

- Unwind only the length of cable needed from the AM antenna unit.
- The wires of the AM antenna have no polarity.

### DAB/FM antenna (U.K., Europe, Australia and Russia models)

Connect the supplied DAB/FM antenna to the unit and fix the antenna ends to a wall.

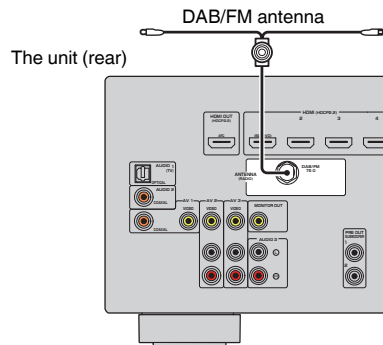

#### Note

- The antenna should be stretched out horizontally.
- If you cannot obtain good reception on the radio, adjust the height, direction or placement of the DAB/FM antenna.

## 5 Preparing for connecting to a network

Connect the unit to a router (access point) with a network cable, or prepare the wireless antenna for establishing a wireless network connection.

You can enjoy Internet radio or music files stored on media servers, such as PCs and Network Attached Storage (NAS), on the unit.

### Connecting a network cable

Connect the unit to your router with a commercially-available STP network cable (CAT-5 or higher straight cable).

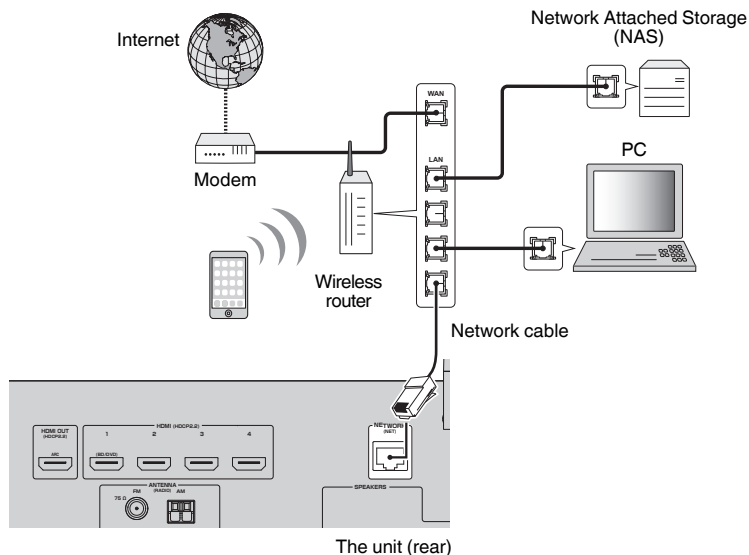

#### Note

- If you are using a router that supports DHCP, you do not need to configure any network settings for the unit, as the network parameters (such as the IP address) will be assigned automatically to it. You only need to configure the network settings if your router does not support DHCP or if you want to configure the network parameters manually (p.108).
- You can check whether the network parameters (such as IP address) are properly assigned to the unit in "Information" (p.108) in the "Setup" menu.
- Some security software installed on your PC or the firewall settings of network devices (such as a router) may block the access of the unit to the network devices or the Internet. In these cases, configure the security software or firewall settings appropriately.
- Each server must be connected to the same subnet as the unit.
- To use the service via the Internet, broadband connection is strongly recommended.

### Preparing a wireless antenna

If you connect the unit wirelessly, erect the wireless antenna.

For information on how to connect the unit to a wireless network, see "Connecting to a network wirelessly" (p.39).

Erect the wireless antenna.

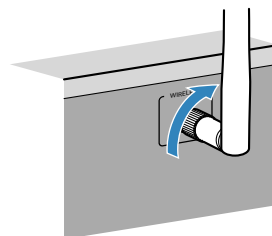

#### Note

Do not apply excessive force on the wireless antenna. Doing so may damage the antenna.

## 6 Connecting the power cable

After all the connections are complete, plug in the power cable.

The unit (rear)

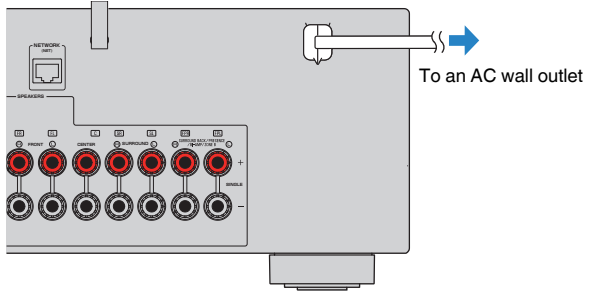

## 7 Selecting an on-screen menu language

Select the desired on-screen menu language.

- 1 Press **⏻** (receiver power) to turn on the unit.
- 2 Turn on the TV and switch the TV input to display video from the unit (HDMI OUT jack).

### Note

- Operations with TV screen are available only when your TV is connected to the unit via HDMI. If not, carry out operations while viewing the front display.
- When you turn on the unit for the first time, a message regarding the network setup appears. You can switch the language on this message screen.

- 3 Press **SETUP**.
- 4 Use the cursor keys to select “Language” and press **ENTER**.

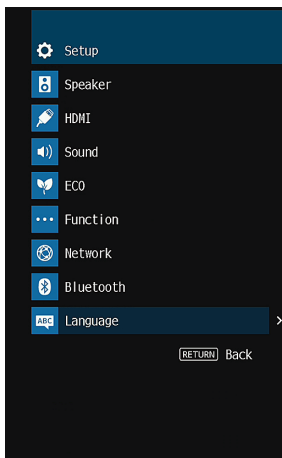

- 5 Use the cursor keys to select the desired language.

- 6 To exit from the menu, press **SETUP**.

### Note

The information on the front display is provided in English only.

## 8 Configuring the necessary speaker settings

If you use any of the following speaker configurations, follow the procedure below to configure the corresponding speaker settings manually before performing YPAO.

- Using surround back speakers (p.18), bi-amp connection (p.81) or Zone B speakers (p.82)
- Using the surround speakers for front 5.1-channel system (Virtual CINEMA FRONT) (p.19)
- Using the presence speakers for Dolby Atmos or DTS:X playback (p.21)

**1 Press  (receiver power) to turn on the unit.**

**2 Turn on the TV and switch the TV input to display video from the unit (HDMI OUT jack).**

### Note

If you turn on the unit for the first time, the message regarding the network setup appears. For now, press RETURN and proceed to Step 3.

**3 Press SETUP.**

**4 Use the Cursor keys to select “Speaker” and press ENTER.**

**5 Use the Cursor keys to select “Configuration” and press ENTER.**

**6 Configure the corresponding speaker settings.**

- When using surround back speakers, bi-amp connections or Zone B speakers, select “Power Amp Assign” (p.94), then select your speaker system.
- When using the surround speakers for front 5.1-channel system (Virtual CINEMA FRONT), select “Virtual CINEMA FRONT” (p.97), then select “On”.
- When using the presence speakers for Dolby Atmos or DTS:X playback, select “Layout” (p.96), then select your presence speaker layout.

**7 To exit from the menu, press SETUP.**

## 9 Optimizing the speaker settings automatically (YPAO)

The Yamaha Parametric room Acoustic Optimizer (YPAO) function detects speaker connections, measures the distances from them to your listening position(s), and then automatically optimizes the speaker settings, such as volume balance and acoustic parameters, to suit your room.

### Note

- When you use the front 5.1-channel speaker (Virtual CINEMA FRONT) configuration (p.19), set “Virtual CINEMA FRONT” (p.97) in the “Setup” menu to “On” beforehand.
- Please note the following when using YPAO.
  - Use YPAO after connecting a TV and speakers to the unit.
  - During the measuring process, test tones are output at high volume. Ensure that the test tones do not frighten small children.
  - During the measuring process, you cannot adjust the volume.
  - During the measuring process, keep the room as quiet as possible.
  - Do not connect headphones.
  - Do not stand between the speakers and the YPAO microphone during the measurement process (about 3 minutes).

**1** Press  (receiver power) to turn on the unit.

**2** Turn on the TV and switch the TV input to display video from the unit (HDMI OUT jack).

### Note

Operations with TV screen are available only when your TV is connected to the unit via HDMI. If not, carry out operations while viewing the front display.

**3** Turn on the subwoofer and set the volume to half. If the crossover frequency is adjustable, set it to maximum.

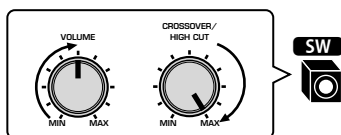

**4** Place the YPAO microphone at your listening position and connect it to the YPAO MIC jack on the front panel.

### Note

Place the YPAO microphone at your listening position (same height as your ears). We recommend the use of a tripod as a microphone stand. You can use the tripod screws to stabilize the microphone.

The unit (front)

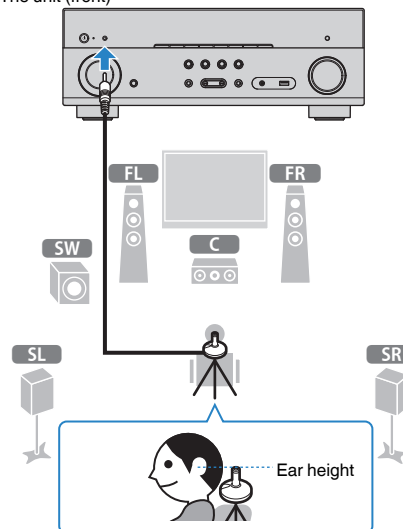

The following screen appears on the TV.

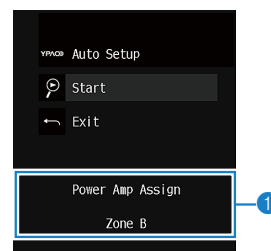

**1** “Power Amp Assign” setting (p.94)

## 5 To start the measurement, use the cursor keys to select “Start” and press ENTER.

The measurement will start in 10 seconds. Press ENTER to start the measurement immediately.

### Note

To stop the measurement temporarily, press RETURN and follow the procedure in “Error messages” (p.37).

The following screen appears on the TV when the measurement finishes.

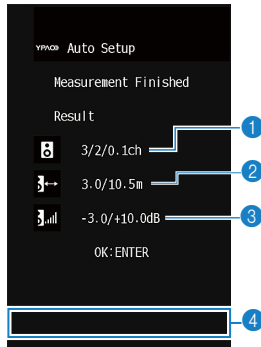

- 1 The number of speakers (front side/rear side/subwoofer)
- 2 Speaker distance (nearest/farthest)
- 3 Adjustment range of speaker output level
- 4 Warning message (if available)

### Note

- If any error message (such as E-1) or warning message (such as W-1) appears, see “Error messages” (p.37) or “Warning messages” (p.38).
- A speaker with a problem is indicated by blinking of the speaker indicators in the front display.
- If multiple warnings are given (when operating with the front display), use the cursor keys ( $\Delta/\nabla$ ) to check the other warning messages.

## 6 Confirm the results displayed on the screen and press ENTER.

## 7 Use the cursor keys ( $\triangle/\nabla$ ) to select “SAVE” and press ENTER.

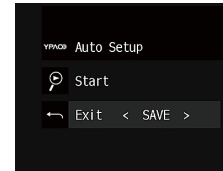

The adjusted speaker settings are applied.

### Note

To finish the measurement without saving the result, select “CANCEL”.

## 8 Disconnect the YPAO microphone from the unit.

This completes optimization of the speaker settings.

### Notice

- The YPAO microphone is sensitive to heat, so should not be placed anywhere where it could be exposed to direct sunlight or high temperatures (such as on top of AV equipment).



## Error messages

If any error message is displayed during the measurement, resolve the problem and perform YPAO again.

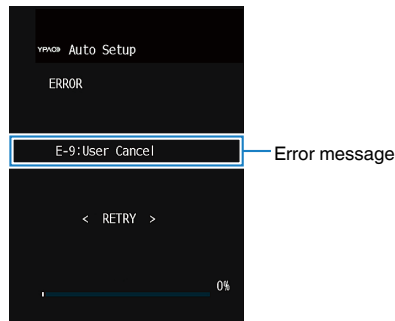

TV screen



Front display

### ■ Procedure to handle errors

- 1 Check the content of error message and press ENTER.
- 2 Use the cursor keys (</>) to select the desired operation.

To exit the YPAO measurement:

- 1 Select “EXIT” and press ENTER.
- 2 Use the cursor keys (Δ/▽) to select “Exit” and press ENTER.
- 3 Disconnect the YPAO microphone from the unit.

To retry the YPAO measurement from beginning:

- 1 Select “RETRY” and press ENTER.

To proceed with the current YPAO measurement (for E-5 and E-9 only):

- 1 Select “PROCEED” and press ENTER.

Error message	Cause	Remedy
<b>E-1:No Front SP</b> <b>(E-1:NO FRNT SP)</b>	Front speakers are not detected.	
<b>E-2:No Sur. SP</b> <b>(E-2:NO SUR SP)</b>	One of the surround speakers cannot be detected.	Exit YPAO, turn off the unit, and then check the speaker connections.
<b>E-3:No F.PRNS SP</b> <b>(E-3:NO FPR SP)</b>	One of the presence speakers cannot be detected.	
<b>E-4:SBR → SBL</b> <b>(E-4:SBR → SBL)</b>	A surround back speaker is connected to the R side only.	When using only one surround back speaker, you need to connect it to the SINGLE jack (L side). Exit YPAO, turn off the unit, and then reconnect the speaker.
<b>E-5:Noisy</b> <b>(E-5:NOISY)</b>	The noise is too loud.	Keep the room quiet and retry YPAO. If you select “PROCEED”, YPAO takes the measurement again and ignores any noise detected.
<b>E-6:Check Sur.</b> <b>(E-6:CHECK SUR)</b>	Surround back speakers are connected, but no surround speakers are connected.	Surround speakers need to be connected in order to use surround back speakers. Exit YPAO, turn off the unit, and then reconnect the speakers.
<b>E-7:No MIC</b> <b>(E-7:NO MIC)</b>	The YPAO microphone has been removed.	Connect the YPAO microphone to the YPAO MIC jack firmly and retry YPAO.
<b>E-8:No Signal</b> <b>(E-8:NO SIGNAL)</b>	The YPAO microphone cannot detect test tones.	Connect the YPAO microphone to the YPAO MIC jack firmly and retry YPAO. If this error occurs repeatedly, contact the nearest authorized Yamaha dealer or service center.
<b>E-9:User Cancel</b> <b>(E-9:CANCEL)</b>	The measurement has been canceled.	Retry or exit YPAO as necessary.
<b>E-10:Internal Err.</b> <b>(E-10:INTERNAL)</b>	An internal error has occurred.	Exit YPAO, and turn off and on the unit. If this error occurs repeatedly, contact the nearest authorized Yamaha dealer or service center.

#### Note

Texts in parentheses denote indicators on the front display.

## Warning messages

If a warning message is displayed after the measurement, you can still save the measurement results by following on-screen instructions.

However, we recommend you perform YPAO again in order to use the unit with the optimal speaker settings.



Warning message

TV screen

Problem speaker (blinks)



Front display

## Procedure to handle warnings

- 1 Check the content of warning message and press ENTER.
- 2 Use the cursor keys (◀/▶) to select the desired operation.
  - To save the measurement results:
    - 1 Select “SAVE” and press ENTER.
  - To discard the measurement result:
    - 1 Select “CANCEL” and press ENTER.
- 3 Disconnect the YPAO microphone from the unit.

Warning message	Cause	Remedy
<b>W-1: Out of Phase (W-1:PHASE)</b>	A speaker cable may be connected with the reverse polarity (+/-).	<p>Check the cable connections (+/-) of the problem speaker.</p> <p><b>If the speaker is connected incorrectly:</b> Turn off the unit, reconnect the speaker cable.</p> <p><b>If the speaker is connected correctly:</b> Depending on the type of speakers or room environment, this message may appear even if the speakers are connected correctly. In this case, you can ignore the message.</p>
<b>W-2: Over Distance (W-2:DISTANCE)</b>	A speaker is placed more than 24 m (80 ft) from the listening position.	Exit YPAO, turn off the unit, and place the problem speaker within 24 m (80 ft) of the listening position.
<b>W-3: Level Error (W-3:LEVEL)</b>	There are significant volume differences between the speakers.	Check the usage environment and cable connections (+/-) of each speaker, and the volume of the subwoofer. If there is any problem, exit YPAO, turn off the unit, and then reconnect speaker cable or correct the speaker positions. We recommend using the same speakers or speakers with specifications that are as similar as possible.

### Note

Texts in parentheses denote indicators on the front display.

## 10 Connecting to a network wirelessly

Connect the unit to a wireless router (access point) or a mobile device by establishing a wireless connection.

### Note

When you connect the unit to a router with a network cable, you need not do this procedure.

## Selecting the connection method

Select a connection method according to your network environment.

### Connecting with a wireless router (access point)

Connect the unit to a wireless router (access point).

You can enjoy Internet radio, AirPlay, or music files stored on media servers (PC/NAS) on the unit.

You can also use the application for smartphone / tablet “AV CONTROLLER” (p.9) to control the unit from mobiles devices or enjoy music files stored on mobiles devices on the unit.

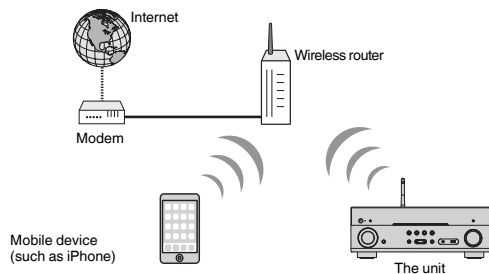

For details on connection, see “Connecting the unit to a wireless network” (p.40).

### Note

- You cannot use the wireless LAN connection simultaneously with the wired LAN connection (p.31) or Wireless Direct (p.45).
- If the unit and the wireless router (access point) are too far apart, the unit may not connect to a wireless router (access point). In such case, place them close to each other.

### Connecting without a wireless router (access point)

Connect a mobile device to the unit directly.

You can use the application for smartphone / tablet “AV CONTROLLER” (p.9) to control the unit from mobiles devices or enjoy music files stored on mobiles devices on the unit.



For details on connection, see “Connecting a mobile device to the unit directly (Wireless Direct)” (p.45).

### Note

- You cannot use Wireless Direct simultaneously with the wired LAN connection (p.31) or the wireless LAN connection (p.40).
- When Wireless Direct is enabled, the unit cannot connect to the Internet. Therefore, you cannot use any kind of Internet service such as Internet radio.
- Also the mobile device cannot connect to the Internet, so we recommend you disconnect the mobile device from the unit.

## Connecting the unit to a wireless network

There are several methods to connect the unit to a wireless network. Select a connection method according to your environment.

- The connection setting to MusicCast network.
  - “Setting the MusicCast” (p.47)
- The connection settings on iOS devices
  - “Sharing the iOS device setting” (p.40)
- The WPS button configuration method
  - “Using the WPS button configuration” (p.41)
- Other connection methods
  - “Using other connection methods” (p.42)

### ■ Sharing the iOS device setting

You can easily setup a wireless connection by applying the connection settings on iOS devices (iPhone/iPad/iPod touch).

Before proceeding, confirm that your iOS device is connected to a wireless router.

#### Note

- The sharing process will restore the default settings for the following.
  - Network settings
  - Bluetooth settings
  - USB and network items registered as shortcuts
  - Internet radio stations registered to “Favorites”
  - Account information for the network services
- You need iOS device with iOS 7 or later. (The following procedure is a setup example for iOS 10.)
- This configuration does not work if the security method of your wireless router (access point) is WEP. In this case, use other connection method.

- 1 Press  (receiver power) to turn on the unit.**
- 2 Turn on the TV and switch the TV input to display video from the unit (HDMI OUT jack).**

**Note**  
Operations with TV screen are available only when your TV is connected to the unit via HDMI.
- 3 Press SETUP.**
- 4 Use the cursor keys ( $\Delta/\nabla$ ) to select “Network” and press ENTER.**

- 5 Use the cursor keys ( $\Delta/\nabla$ ) to select “Network Connection” and press ENTER.**

- 6 Use the cursor keys ( $\leftarrow/\rightarrow$ ) to select “Wireless(Wi-Fi)” and press ENTER.**

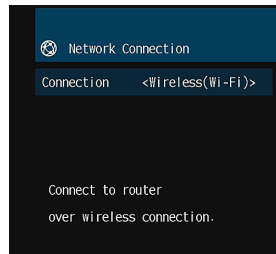

- 7 Use the cursor keys ( $\Delta/\nabla$ ) to select “WAC(iOS)” and press ENTER.**

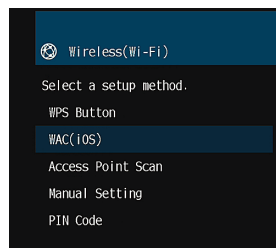

- 8 Read the on-screen description and press ENTER.**

#### Note

When you use wired network connection, a warning message is displayed on the screen. Disconnect the network cable from the unit, and then press ENTER.

## 9 On the iOS device, select the unit as the AirPlay speaker in the Wi-Fi screen.

### iOS 10 (example of English version)

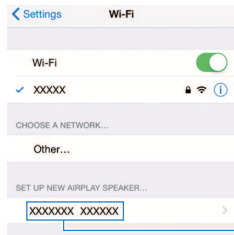

The name of the unit

## 10 Select the network (access point) of which you want to share the settings with the unit.

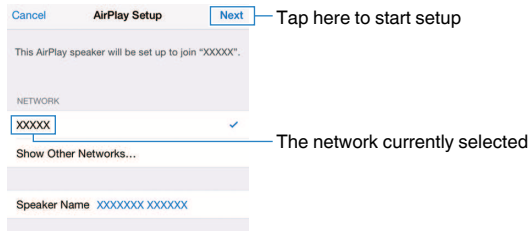

The network currently selected

When the sharing process finishes, the unit is automatically connected to the selected network (access point) and “Completed” appears on the front display.

If “Not shared” or “Not connected” appears, press ENTER to repeat from step 5 or try another connection method.

## 11 To exit from the menu, press SETUP.

## Using the WPS button configuration

You can easily set up a wireless connection with one push of the WPS button.

**1** Press **⏻** (receiver power) to turn on the unit.

**2** Hold down **INFO (WPS)** on the front panel for 3 seconds.

“Press WPS button on Access Point” appears on the front display.

**3** Push the **WPS button on the wireless router (access point)**.

When the connection process finishes, “Completed” appears on the front display.

If “Not connected” appears, repeat from step 1 or try another connection method.

### Note

- Depending on the model of the wireless router (access point), the unit may not connect to it. In this case, try connection with “Access Point Scan” or “Manual Setting” (p.42).
- You can use “WPS Button” (p.42) in the “Setup” menu to set up a wireless connection with the WPS button.

### About WPS

- WPS (Wi-Fi Protected Setup) is a standard established by the Wi-Fi Alliance, which allows easy establishment of a wireless home network.

## ■ Using other connection methods

If your wireless router (access point) does not support WPS button configuration method, follow the procedure below to configure the wireless network settings.

- 1 Press **⏻** (receiver power) to turn on the unit.
- 2 Turn on the TV and switch the TV input to display video from the unit (HDMI OUT jack).  
**Note**  
Operations with TV screen are available only when your TV is connected to the unit via HDMI.
- 3 Press **SETUP**.
- 4 Use the cursor keys (**△/▽**) to select “Network” and press **ENTER**.
- 5 Use the cursor keys (**△/▽**) to select “Network Connection” and press **ENTER**.
- 6 Use the cursor keys (**◀/▶**) to select “Wireless(Wi-Fi)” and press **ENTER**.

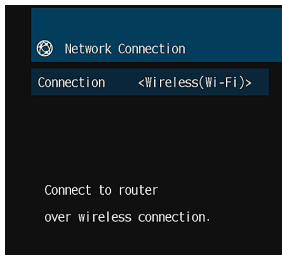

### Note

The unit may connect automatically to the access point to which it has connected previously. In this case, the message indicating the successful connection will appear. You can ignore this message and proceed to the next step.

- 7 Use the cursor keys (**△/▽**) to select the desired connection method and press **ENTER**.

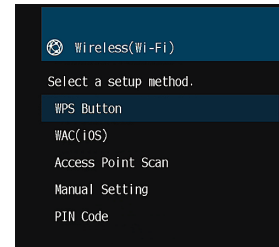

The following connection methods are available.

<b>WPS Button</b>	You can set up a wireless connection with the WPS button while viewing the TV screen. Follow the instructions displayed on the TV screen.
<b>WAC(iOS)</b>	See “Sharing the iOS device setting” (p.40).
<b>Access Point Scan</b>	You can set up a wireless connection by searching for an access point. For details on settings, see “Searching for an access point” (p.43).
<b>Manual Setting</b>	You can setup a wireless connection by entering the required information (such as SSID) manually. For details on settings, see “Setting up the wireless connection manually” (p.44).
<b>PIN Code</b>	You can set up a wireless connection by entering the unit’s PIN code into the wireless router (access point). The method is available if the wireless router (access point) supports the WPS PIN code method. For details on settings, see “Using the WPS PIN code” (p.45).

## Searching for an access point

If you select "Access Point Scan" as the connection method, the unit starts searching for access points. After a while, the list of available access points appears on the TV screen.

### 1 Use the cursor keys ( $\Delta/\nabla$ ) to select the desired access point and press ENTER.

The wireless connection setting screen appears on the TV.

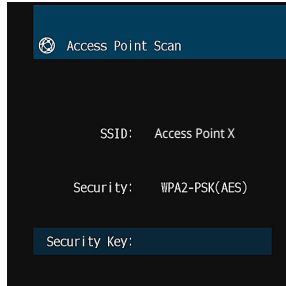

### 2 Press ENTER.

### 3 Use the cursor keys and ENTER to enter the security key.

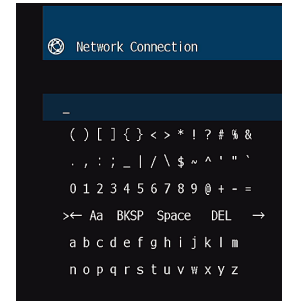

#### Button functions

- [←]/[→]: Moves the cursor left and right.
- [Aa]: Switches the letter cases (upper/lower).
- [BKSP]: Deletes the character to the left of the selected one.
- [Space]: Enters a space.
- [DEL]: Deletes the selected character.

When finished entering the key, select "OK" to return to the previous screen.

### 4 Use the cursor keys ( $\Delta/\nabla$ ) to select "Connect" and press ENTER to start the connection process.

When the connection process finishes, "Completed" appears on the TV screen.

If "Not connected" appears, repeat from step 1 or try another connection method.

### 5 To exit from the menu, press SETUP.

## Setting up the wireless connection manually

If you select "Manual Setting" as the connection method, the wireless connection setting screen appears on the TV.

You need to setup the SSID (network name), encryption method and security key for your network.

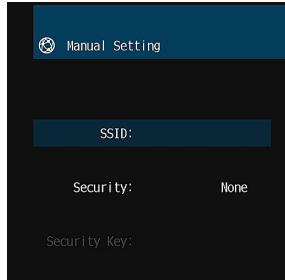

- 1 Use the cursor keys ( $\Delta/\nabla$ ) to select "SSID" and press ENTER.
- 2 Use the cursor keys and ENTER to enter the SSID of the access point.

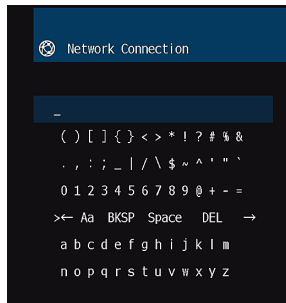

When finished entering the key, select "OK" to return to the previous screen.

- 3 Use the cursor keys ( $\Delta/\nabla$ ) to select "Security" and the cursor keys ( $\triangleleft/\triangleright$ ) to select the encryption method.

### Choices

None, WEP, WPA-PSK(AES), Mixed Mode

### Note

If you select "None", the connection may be insecure since the communication is not encrypted.

- 4 Use the cursor keys ( $\Delta/\nabla$ ) to select "Security Key" and press ENTER.

### Note

If you select "None" in step 3, this item is not available.

- 5 Use the cursor keys and ENTER to enter the security key.

If you select "WEP" in step 3, enter either 5 or 13 character string, or 10 or 26 hexadecimal digits.

If you select the method other than "WEP" in step 3, enter either 8 to 63 character string, or 64 hexadecimal digits.

When finished entering the key, select "OK" to return to the previous screen.

- 6 Use the cursor keys ( $\Delta/\nabla$ ) to select "Connect" and press ENTER to start the connection process.

When the connection process finishes, "Completed" appears on the TV screen.

If "Not connected" appears, check that all the information is entered correctly, and repeat from step 1.

- 7 To exit from the menu, press SETUP.



## Using the WPS PIN code

If you select "PIN Code" as the connection method, the list of available access points appears on the TV screen.

### 1 Use the cursor keys ( $\Delta/\nabla$ ) to select the desired access point and press ENTER.

The PIN code of the unit appears on the TV screen.

### 2 Enter the unit's PIN code into the wireless router (access point).

For details on settings, refer to the instruction manual of the wireless router (access point).

### 3 Press ENTER to start the connection process.

When the connection process finishes, "Completed" appears on the TV screen.

If "Not connected" appears, repeat from step 1 or try another connection method.

### 4 To exit from the menu, press SETUP.

## Connecting a mobile device to the unit directly (Wireless Direct)

Follow the procedure below to connect a mobile device to the unit directly.

### Note

Wireless Direct connection may be insecure since the communication is not strongly encrypted. The unit may operate by playback operation on wireless devices connected to the unit without permission.

### 1 Press $\text{⏻}$ (receiver power) to turn on the unit.

### 2 Turn on the TV and switch the TV input to display video from the unit (HDMI OUT jack).

### Note

Operations with TV screen are available only when your TV is connected to the unit via HDMI.

### 3 Press SETUP.

### 4 Use the cursor keys ( $\Delta/\nabla$ ) to select "Network" and press ENTER.

### 5 Use the cursor keys ( $\Delta/\nabla$ ) to select "Network Connection" and press ENTER.

### 6 Use the cursor keys ( $\leftarrow/\rightarrow$ ) to select "Wireless Direct" and press ENTER.

### 7 Use the cursor keys ( $\Delta/\nabla$ ) to select "Security" and the cursor keys ( $\leftarrow/\rightarrow$ ) to select the encryption method.

### Choices

None, WPA2-PSK(AES)

### Note

If you select "None", the connection may be insecure since the communication is not encrypted.

### 8 Use the cursor keys ( $\Delta/\nabla$ ) to select "Security Key" and press ENTER.

### Note

If you select "None" in step 7, this item is not available.

## 9 Use the cursor keys and ENTER to enter the security key.

Enter either 8 to 63 character string, or 64 hexadecimal digits.

When finished entering the key, select "OK" to return to the previous screen.

### Note

Before proceeding to the next step, record the following information. These information will be needed to configure the Wi-Fi setting of a mobile device.

- SSID displayed on the TV screen
- Security key you have just entered

## 10 Use the cursor keys ( $\Delta/\nabla$ ) to select "Save" and press ENTER to save the setting.

This completes the settings and "Completed" appears on the TV screen.

Next, configure the Wi-Fi settings of a mobile device.

## 11 Configure the Wi-Fi settings of a mobile device.

For details on settings of your mobile device, refer to the instruction manual of the mobile device.

- 1 Enable the Wi-Fi function on the mobile device.
- 2 Select the SSID displayed in step 9 from the list of available access points.
- 3 When you are prompted for a password, enter the security key displayed in step 9.

## 12 To exit from the menu, press SETUP.

## 11 Setting the MusicCast

MusicCast is a brand new wireless musical solution from Yamaha, allowing you to share music among all of your rooms with a variety of devices. You can enjoy music from your smartphone, PC, NAS drive and music streaming service anywhere in your house with one easy-to-use application. For more details and a lineup of MusicCast compatible products, refer to the following site:

<http://www.yamaha.com/musiccast/>

- Seamlessly control all MusicCast compatible devices with the dedicated application “MusicCast CONTROLLER”.
- Link a MusicCast compatible device to another device in a different room and play them back simultaneously.
- Play back music from music streaming services. (The compatible music streaming services may differ depending on your region and product).

### Note

Access the Yamaha Downloads site (<http://download.yamaha.com/>) to download MusicCast Setup Guide.

## MusicCast CONTROLLER



To use the network features on the MusicCast compatible device, you need the dedicated application “MusicCast CONTROLLER” for the operation. Search for the free application “MusicCast CONTROLLER” on the App Store or Google Play and install it to your device.

## Adding the unit to the MusicCast network

Follow the procedure below to add the unit to the MusicCast network. You can also configure the unit’s wireless network settings at once.

### Note

The SSID and security key for your network will be needed.

- 1 Press  (receiver power) to turn on the unit.

- 2 Tap the “MusicCast CONTROLLER” application icon on your mobile device and tap “Setup”.

### Note

If you have already connected other MusicCast compatible devices to the network, tap “Settings” and then “Add New Device”.

- 3 Operate the “MusicCast CONTROLLER” application following the on screen instructions, then hold down CONNECT on the front panel of the unit for 5 seconds.

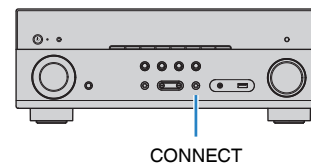

- 4 Operate the “MusicCast CONTROLLER” application following the onscreen instructions to set up the network.

- 5 Operate the “MusicCast CONTROLLER” application to playback.

### Note

- AirPlay and DSD audio cannot be delivered.
- When the direct playback mode is enabled, input sources other than the network sources and USB cannot be delivered.
- If you configure the unit’s wireless settings with this method, the signal strength indicator of the front display lights up when the unit is connecting to a network (even if a wired connection is used).
- You can interlock the power of MusicCast devices with the power of the unit (the MusicCast master). For details, see “MusicCast Link Power Interlock” (p.110) in the “Setup” menu.

# PLAYBACK

## Basic playback procedure

### Enjoying playback

- 1 Turn on the external devices (such as a TV or BD/DVD player) connected to the unit.
- 2 Use the input selection keys to select an input source.

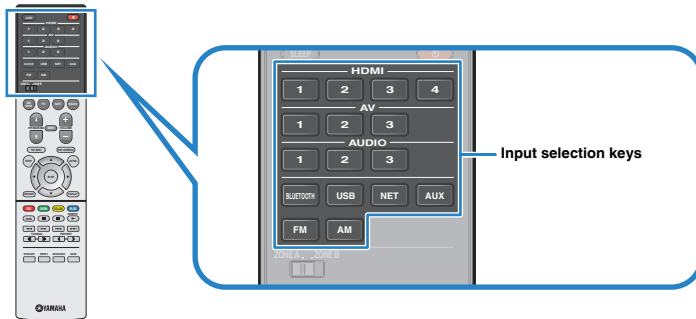

### 3 Start playback on the external device or select a radio station.

Refer to the instruction manual for the external device.

For details on the following operations, see the corresponding pages.

- “Listening to FM/AM radio (Except for U.K., Europe, Australia and Russia models)” (p.56)
- “Listening to DAB radio (U.K., Europe, Australia and Russia models)” (p.60)
- “Listening to FM radio (U.K., Europe, Australia and Russia models)” (p.65)
- “Playing back music stored on a Bluetooth® device” (p.69)
- “Playing back music stored on a USB storage device” (p.73)
- “Playing back music stored on media servers (PCs/NAS)” (p.76)
- “Listening to Internet radio” (p.79)
- “Playing back music with AirPlay” (p.71)

### 4 Press VOLUME to adjust the volume.

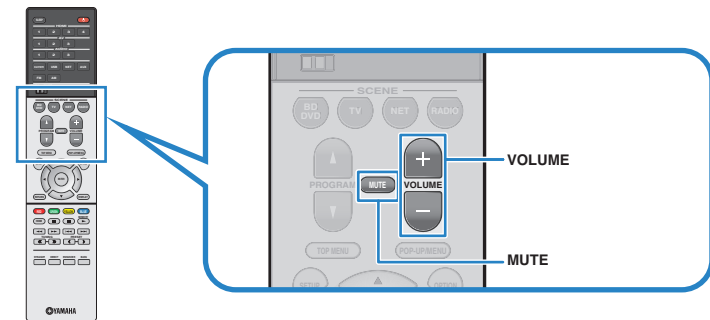

#### Note

- To mute the audio output, press MUTE. Press MUTE again to unmute.
- To adjust the treble/bass settings, use the “Option” menu or TONE CONTROL on the front panel (p.88).

## Switching information on the front display

- 1 Press **INFO** repeatedly to select between the various display items.



Item name

About 3 seconds after a display item is selected, its corresponding information appears.



Information

### Note

Available items vary depending on the selected input source. The displayed item can also be applied separately to each input group which is shown in the table below and divided by ruled lines.

Currently input source	Item
<b>HDMI</b>	
<b>AV</b>	Input (input source name), DSP Program (sound mode name), Audio Decoder (decoder name*)
<b>AUX</b>	Decoder (decoder name*)
<b>AUDIO</b>	
<b>Bluetooth</b>	Song (song title), Artist (artist name), Album (album name), DSP Program (sound mode name), Audio Decoder (decoder name*)
<b>USB</b>	Song (song title), Artist (artist name), Album (album name), DSP Program (sound mode name), Audio Decoder (decoder name*)
<b>SERVER</b>	Song (song title), Artist (artist name), Album (album name), DSP Program (sound mode name), Audio Decoder (decoder name*), IP Address, Ethernet MAC, Wi-Fi MAC
<b>AirPlay</b>	Song (song title), Album (album name), Station (station name), DSP Program (sound mode name), Audio Decoder (decoder name*), IP Address, Ethernet MAC, Wi-Fi MAC
<b>NET RADIO</b>	Song (song title), Album (album name), Station (station name), DSP Program (sound mode name), Audio Decoder (decoder name*), IP Address, Ethernet MAC, Wi-Fi MAC
<b>MusicCast Link</b>	DSP Program (sound mode name), Audio Decoder (decoder name*), IP Address, Ethernet MAC, Wi-Fi MAC
	Frequency (frequency), DSP Program (sound mode name), Audio Decoder (decoder name*)
<b>TUNER (FM/AM)</b>	(U.K. and Europe models only) Radio Data System data is also available when the unit is tuned into a Radio Data System broadcasting station (p.68).
<b>TUNER (DAB)</b>	See "Displaying the DAB information" (p.63) for details.

\* The name of the audio decoder currently activated is displayed. If no audio decoder is activated, "Decoder Off" appears.

## Selecting the input source and favorite settings with one touch (SCENE)

The SCENE function allows you to select the assigned input source, sound program, Compressed Music Enhancer on/off, and target zones with just one touch.

### Selecting a registered scene

#### 1 Press SCENE.

The input source and settings registered to the corresponding scene are selected. The unit turns on automatically when it is in standby mode.

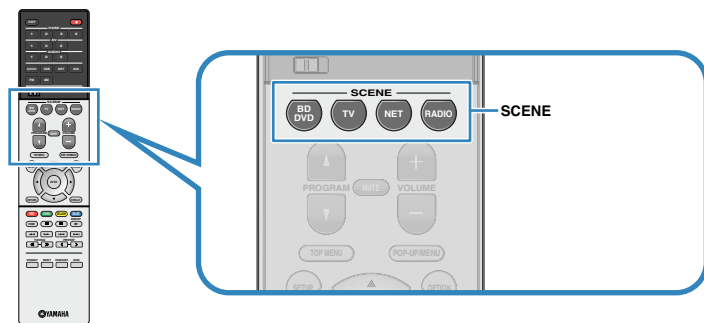

By default, the following settings are registered for each scene.

SCENE	BD DVD	TV	NET	RADIO
<b>Input</b>	HDMI1	AUDIO1	NET RADIO	TUNER
<b>Sound program</b>	Sci-Fi	STRAIGHT	7ch Stereo	7ch Stereo
<b>Compressed Music Enhancer</b>	Off	On	On	On
<b>SCENE link playback</b>	On	On	Off	Off
<b>Target zone</b>	Zone A	Zone A	Zone A	Zone A

#### Note

The SCENE link playback function allows you to automatically turn on the TV or start playback of an external device connected to the unit via HDMI, in conjunction with a scene selection. To enable SCENE link playback, set "SCENE" (p.100) in the "Setup" menu to "On".

### Registering a scene

#### 1 Perform the following operations to prepare the settings you want to assign to a scene.

- Select an input source (p.48)
- Select a sound program (p.51) or straight decode (p.54)
- Enable/disable Compressed Music Enhancer (p.55)
- Enable/disable the audio output to Zone A/B (p.83)

#### 2 Hold down the desired SCENE key until "SET Complete" appears on the front display.



## Selecting the sound mode

The unit is equipped with a variety of sound programs and surround decoders that allow you to enjoy playback sources with your favorite sound mode (such as sound field effect or stereo playback).

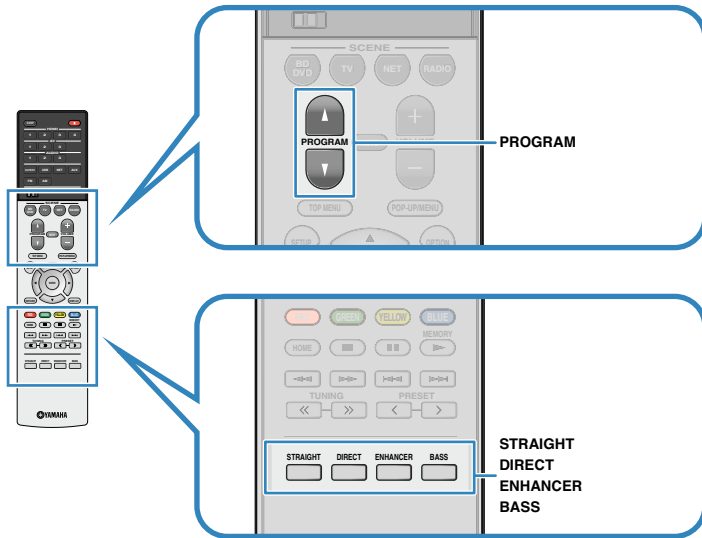

### I want to enjoy viewing video sources such as movies, TV programs, or games.

- Select a sound program suitable for each video source by pressing PROGRAM repeatedly (p.52).

### I want to enjoy listening to music sources or stereo playback.

- Select a sound program suitable for music or stereo playback by pressing PROGRAM repeatedly (p.53).

### I want to enjoy multichannel playback from 2-channel sources.

- Select a surround decoder in the "Option" menu (p.87).

### I want to enjoy unprocessed sounds in original channels.

- Switch to the straight decode mode by pressing STRAIGHT (p.54).

### I want to enjoy pure high fidelity sounds.

- Enable the direct playback mode by pressing DIRECT (p.55).

This mode reduces the electrical noise from other circuitry to allow you to enjoy Hi-Fi sound quality.

### I want to enjoy enhanced bass sounds.

- Enable Extra Bass by pressing BASS (p.55).

### I want to enjoy listening to compressed music.

- Enable Compressed Music Enhancer by pressing ENHANCER (p.55).

This mode lets you enjoy listening to compressed music from Bluetooth devices, USB devices, etc. as it gives the music additional depth and breadth (p.55).

#### Note

- The sound mode can be applied separately to each input source.
- You can check which speakers are currently outputting sound by looking at the speaker indicators on the unit's front panel (p.12).

#### Precaution for enjoying Dolby Atmos®

- Dolby Atmos contents are decoded as Dolby TrueHD or Dolby Digital Plus in the following situations. (Dolby Atmos PCM format is always decoded as Dolby Atmos.)
  - Any of CINEMA DSP programs is selected.
  - Neither surround back nor presence speakers are used.
  - Headphones are used (2-channel playback).
- When the Dolby Atmos decoder is working, virtual surround processing (such as Virtual CINEMA FRONT) (p.52) or Compressed Music Enhancer (p.55) does not work.

#### Precaution for enjoying DTS:X™

- DTS:X contents are decoded as DTS-HD format when any of CINEMA DSP programs is selected.
- When the DTS:X decoder is working, virtual surround processing (such as Virtual CINEMA FRONT) (p.52), Dialogue Level (p.102), Extra Bass (p.96) or Compressed Music Enhancer (p.55) does not work.
- When DTS:X contents are played back, you can adjust the volume of dialogue sounds in "DTS Dialogue Control" (p.102) in the "Setup" menu.

## Enjoying stereoscopic sound fields (CINEMA DSP 3D)



The unit is equipped with a variety of sound programs that utilize Yamaha's original DSP technology (CINEMA DSP 3D). It allows you to easily create sound fields like actual movie theaters or concert halls in your room and enjoy natural stereoscopic sound fields.

Sound program category

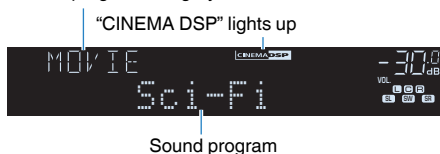

### Note

- You can adjust the sound field effect level in “DSP Level (DSP Level)” (p.88) in the “Option” menu.
- To use the conventional CINEMA DSP, set “CINEMA DSP 3D Mode” (p.101) in the “Setup” menu to “Off”.

## Sound programs suitable for movies (MOVIE)

The following sound programs are optimized for viewing video sources, such as movies, TV programs, and games.

<b>Standard</b>	This program creates a sound field that emphasizes the surround feeling without disturbing the original acoustic positioning of multichannel audio, such as Dolby Digital and DTS. Its design is based on the concept of the ideal movie theater, in which the audience is surrounded by beautiful reverberations from the left, right, and rear.
<b>Spectacle</b>	This program delivers the scale and grandeur of spectacular movie productions. It delivers an expansive sound space to match the cinemascope wide-screen, and boasts a broad dynamic range, providing everything from small delicate sounds to powerful loud booms.
<b>Sci-Fi</b>	This program clearly reproduces the finely elaborated sound design of the latest Sci-Fi and SFX movies. You can enjoy a variety of cinematographically created virtual spaces reproduced with clear separation between dialogue, sound effects, and background music.
<b>Adventure</b>	This program is ideal for reproducing the sound design of action and adventure movies precisely. The sound field restrains reverberations, but puts emphasis on reproducing a sensation of expansiveness on both sides, powerful space expanded widely to the left and right. The restrained depth creates a clear and powerful space, while also maintaining the articulation of the sounds and the separation of the channels.

<b>Drama</b>	This program features stable reverberations that match a wide range of movie genres, from serious dramas to musicals and comedies. The reverberations are modest, but suitably stereophonic. The sound effects and background music are reproduced with a gentle echo that does not impinge on the articulation of the dialogue. You'll never get tired listening for long periods.
<b>Mono Movie</b>	This program reproduces monaural video sources, such as classic movies, in an atmosphere of a good old movie theater. The program creates a pleasant space with depth, by adding breadth and the appropriate reverberation to the original audio.
<b>Sports</b>	This program allows listeners to enjoy the rich vividness of sport broadcasts and light entertainment programs. In sports broadcasts, the commentators' voices are positioned clearly at the center, while the atmosphere inside the stadium is realistically conveyed by the peripheral delivery of the sounds of the fans in a suitable space.
<b>Action Game</b>	This program is suitable for action games, such as car racing and fighting games. The reality of, and emphasis on, various effects makes the player feel like they are right in the middle of the action, allowing for greater concentration. Use this program in combination with Compressed Music Enhancer for a more dynamic and strong sound field.
<b>Roleplaying Game</b>	This program is suitable for role-playing and adventure games. This program adds depth to the sound field for natural and realistic reproduction of background music, special effects, and dialogue from a wide variety of scenes. Use this program in combination with Compressed Music Enhancer for a clearer and more spatial sound field.



## ■ Sound programs suitable for music (MUSIC)

The following sound programs are optimized for listening to music sources.

<b>Hall in Munich</b>	This program simulates a Munich concert hall with approximately 2,500 seats that uses stylish wood for the interior finishing. Fine, beautiful reverberations spread richly, creating a calming atmosphere. The listener's virtual seat is at the center left of the arena.
<b>Hall in Vienna</b>	This program simulates a 1700-seat, middle-sized concert hall with a shoebox shape that is traditional in Vienna. Pillars and ornate carvings create extremely complex reverberations from all around the audience, producing a very full, rich sound.
<b>Chamber</b>	This program creates a relatively wide space with a high ceiling, like an audience hall in a palace. It offers pleasant reverberations that are suitable for courtly music and chamber music.
<b>Cellar Club</b>	This program simulates an intimate concert venue with a low ceiling and homey atmosphere. A realistic, live sound field delivers powerful sounds that make you feel as if you are sitting in the front row in front of a small stage.
<b>The Roxy Theatre</b>	This program creates the sound field of a 460-seat rock music concert venue in Los Angeles. The listener's virtual seat is at the center left of the hall.
<b>The Bottom Line</b>	This program creates the sound field at stage front in The Bottom Line, a famous New York jazz club once. The floor can seat 300 people to the left and right in a sound field offering real and vibrant sound.
<b>Music Video</b>	This program allows you to enjoy videos of pop, rock, and jazz concerts, as if you were there yourself. Immerse yourself in the hot concert atmosphere thanks to the vividness of the singers and solos on stage, a presence sound field that emphasizes the beat of rhythm instruments, and a surround sound field that reproduces the space of a big live hall.

## ■ Sound programs suitable for stereo playback (STEREO)

You can select stereo playback.

<b>2ch Stereo</b>	Use this program to mix down multichannel sources to 2 channels. When multichannel signals are input, they are down mixed to 2 channels and output from the front speakers (this program does not utilize CINEMA DSP).
<b>7ch Stereo</b>	Use this program to output sound from all speakers. When you play back multichannel sources, the unit mixes down the source to 2 channels, and then outputs the sound from all speakers. This program creates a larger sound field and is ideal for background music at parties.

### Note

CINEMA DSP 3D (p.52) and Virtual CINEMA DSP (p.53) do not work when "2ch Stereo" or "7ch Stereo" is selected.

## ■ Enjoying sound field effects without surround speakers (Virtual CINEMA DSP)

If you select one of the sound programs (except 2ch Stereo and 7ch Stereo) when no surround speakers are connected, the unit automatically creates the surround sound field using the front-side speakers.

## ■ Enjoying surround sound with 5 speakers placed in front (Virtual CINEMA FRONT)

You can enjoy the surround sound even when the surround speakers are placed in front.

When "Virtual CINEMA FRONT" (p.97) in the "Setup" menu is set to "On", the unit creates the virtual surround speakers in the rear side to allow you to enjoy multichannel surround sound with the 5 speakers placed in the front.

## ■ Enjoying surround sound with headphones (SILENT CINEMA)

### SILENT™ CINEMA

You can enjoy surround or sound field effects, like a multichannel speaker system, with stereo headphones by connecting the headphones to the PHONES jack and selecting a sound program or a surround decoder.

## Enjoying unprocessed playback

You can play back input sources without any sound field effect processing.

### ■ Playing back in original channels (straight decode)

When the straight decode mode is enabled, the unit produces stereo sound from the front speakers for 2-channel sources such as CDs, and produces unprocessed multichannel sounds for multichannel sources.

#### 1 Press STRAIGHT.

Each time you press the key, the straight decode mode is enabled or disabled.



#### Note

If "Virtual CINEMA FRONT" (p.97) in the "Setup" menu is set to "On", Virtual CINEMA FRONT (p.53) works when multichannel source is played back.

### ■ Playing back 2-channel sources in multichannel (surround decoder)

The surround decoder enables unprocessed multichannel playback from 2-channel sources. When a multichannel source is input, it works the same way as the straight decode mode.

For details on each decoder see "Glossary" (p.127).

#### 1 Press PROGRAM repeatedly to select a surround decoder.

The previously selected surround decoder is selected. You can change the surround decoder in "Sur.Decode" (p.87) in the "Option" menu.

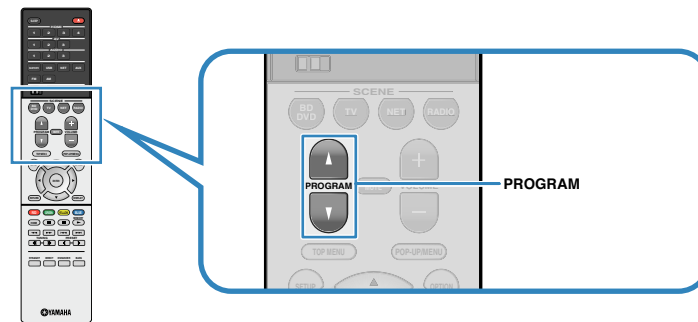

"SUR. DECODE" appears



<b>Auto</b>	Uses the decoder automatically selected by input source. The DTS Neural:X decoder is selected for DTS sources and the Dolby Surround decoder is selected for other sources.
<b>Dsur</b>	Use the Dolby Surround decoder suitable for all sources. A real acoustic space (including overhead) will be created especially when object-based audio (such as Dolby Atmos content) is played.
<b>Neural:X</b>	Use the DTS Neural:X decoder suitable for all sources. A real acoustic space (including overhead) will be created especially when object-based audio (such as DTS:X content) is played.
<b>Neo:6 Cinema</b>	Uses the DTS Neo:6 decoder (or DTS-ES Matrix decoder) suitable for movies. Sounds will be output from the surround/surround back speakers.
<b>Neo:6 Music</b>	Uses the DTS Neo:6 decoder (or DTS-ES Matrix decoder) suitable for music. Sounds will be output from the surround/surround back speakers.

#### Note

- You can adjust the surround decoder parameters in "DSP Parameter" (p.101) in the "Setup" menu.
- When the Dolby Surround decoder is selected, virtual surround processing (such as Virtual CINEMA FRONT) (p.52) or Compressed Music Enhancer (p.55) does not work.
- If the Dolby Surround decoder is selected when only one surround back speaker is used, no sound is output from the surround back speaker (except when a Dolby Atmos content is played).
- When the Neural:X decoder is selected, Dialogue Level (p.102), Extra Bass (p.96) or Compressed Music Enhancer (p.55) does not work.
- The selected surround decoder may not work for some input sources.

## Enjoying pure high fidelity sound (direct playback)

When the direct playback mode is enabled, the unit plays back the selected source with the least circuitry in order to reduce the electrical noise from other circuitry (such as the front display). It allows you to enjoy Hi-Fi sound quality.

### 1 Press DIRECT.

Each time you press the key, the direct playback mode is enabled or disabled.



#### Note

When the direct playback mode is enabled, the following functions are not available.

- Selecting sound programs
- Adjusting the tone control
- Operating the on-screen and "Option" menus
- Viewing information on the front display (when not in operation)

## Enhancing the bass (Extra Bass)

Extra Bass allows you to enjoy enhanced bass sounds, regardless of the size of the front speakers and the presence or absence of the subwoofer.

### 1 Press BASS.

Each time you press the key, Extra Bass is enabled or disabled.

#### Note

You can also use "Extra Bass" (p.96) in the "Setup" menu to enable/disable Extra Bass.

## Playing back digitally compressed formats (such as MP3, etc.) with enriched sound (Compressed Music Enhancer)

### compressed music

### ENHANCER

Compressed Music Enhancer adds depth and breadth to the sound, allowing you to enjoy a dynamic sound close to the original sound before it was compressed. This function can be used along with any other sound modes.

### 1 Press ENHANCER.

Each time you press the key, Compressed Music Enhancer is enabled or disabled.

"ENHANCER" lights up



#### Note

- Compressed Music Enhancer does not work on the following audio sources.
  - Signals whose sampling frequency is over 48 kHz
  - DSD audio
- You can also use "Enhancer (Enhancer)" (p.89) in the "Option" menu to enable/disable Compressed Music Enhancer.

## Listening to FM/AM radio (Except for U.K., Europe, Australia and Russia models)

You can tune into a radio station by specifying its frequency or selecting from registered radio stations.

### Note

If you cannot obtain good reception on the radio, adjust the direction of the FM/AM antennas.

## Selecting a frequency for reception

### 1 Press FM or AM to select a band.

"TUNER" is selected as the input source and then the frequency currently selected is displayed.



### 2 Press TUNING repeatedly to set a frequency.

Hold down the key for about a second to search stations automatically.

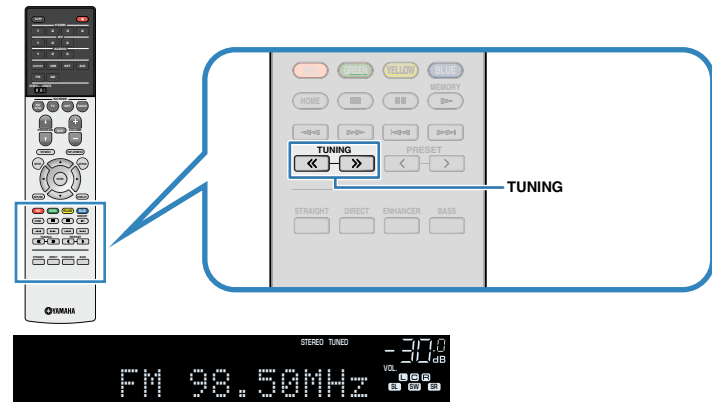

"TUNED" lights up when the unit is receiving an FM/AM radio station signal.

"STEREO" lights up when the unit is receiving a stereo FM radio signal.

### Note

- You can switch between "Stereo" (stereo) and "Mono" (monaural) for FM radio reception by selecting "FM Mode" in the "Option" menu. When the signal reception for an FM radio station is unstable, switching to monaural may improve it.
- You can watch videos input from external devices while listening to radio by selecting the video input jack in "Video Out (Video Out)" (p.90) in the "Option" menu.

## Registering favorite radio stations (presets)

You can register up to 40 radio stations as presets. Once you have registered stations, you can easily tune into them by selecting their preset numbers.

### ■ Registering radio stations automatically (Auto Preset)

Automatically register FM radio stations with strong signals (up to 40 stations).

#### Note

To register AM radio stations, follow "Registering a radio station manually" (p.58).

- 1 Press FM to select "TUNER" as the input source.**
- 2 Press OPTION.**
- 3 Use the cursor keys to select "Preset" and press ENTER.**



- 4 To start the Auto Preset process, press ENTER.**

"SEARCH" appears during Auto Preset



Preset number from which to start the registration

#### Note

- To specify the preset number from which to start the registration, press cursor keys (</>) or PRESET to select a preset number.
- To cancel the Auto Preset process, press RETURN.

When the Auto Preset process finishes, "FINISH" appears and the "Option" menu closes automatically.



## ■ Registering a radio station manually

Select a radio station manually and register it to a preset number.

- 1 Follow “Selecting a frequency for reception” (p.56) to tune into the desired radio station.
- 2 Hold down MEMORY for a few seconds.

The first time that you do register a station, the selected radio station will be registered to the preset number “01”. Thereafter, each radio station you select will be registered to the next empty (unused) preset number after the most recently registered number.

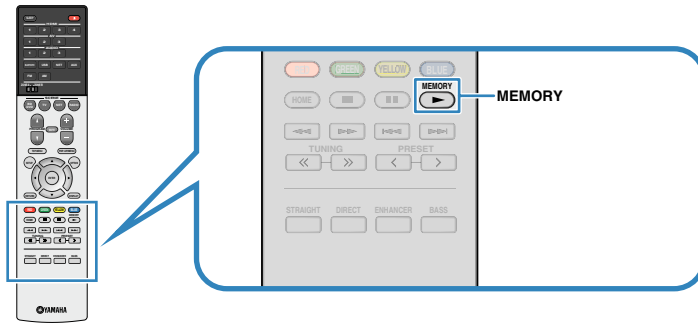

Preset number

### Note

To select a preset number for registering, press MEMORY once after tuning into the desired radio station, press PRESET to select a preset number, and then press MEMORY again.



“Empty” (not in use) or the frequency currently registered

## ■ Selecting a preset station

Tune into a registered radio station by selecting its preset number.

- 1 Press FM or AM to select “TUNER” as the input source.
- 2 Press PRESET repeatedly to select the desired radio station.

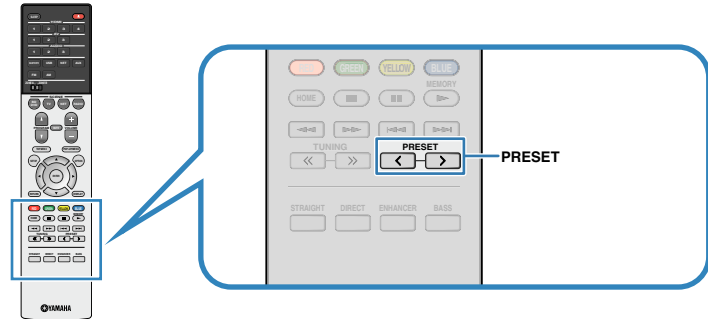

### Note

“No Presets” appears when no radio stations are registered.

## ■ Clearing preset stations

Clear radio stations registered to the preset numbers.

- 1 Press FM or AM to select “TUNER” as the input source.
- 2 Press OPTION.
- 3 Use the cursor keys to select “Preset” and press ENTER.



- 4 Use the cursor keys ( $\Delta/\nabla$ ) to select “CLEAR”.
- 5 Use the cursor keys ( $\leftarrow/\rightarrow$ ) to select a preset station to be cleared and press ENTER.



Preset station to be cleared

If the preset station is cleared, “Cleared” appears and then the next in-use preset number is displayed.



- 6 Repeat step 5 until all desired preset stations are cleared.
- 7 To exit from the menu, press OPTION.

## Listening to DAB radio (U.K., Europe, Australia and Russia models)

DAB (Digital Audio Broadcasting) uses digital signals for clearer sound and more stable reception compared to analog signals. The unit can also receive DAB+ (an upgraded version of DAB) that allows for more stations using MPEG-4 HE-AAC v2 audio codec, which has a more efficient transmission method.

### Note

- The unit supports Band III (174 to 240 MHz) only.
- Be sure to check the DAB coverage in your area in that not all areas are currently being covered. For a list of nationwide DAB statuses and worldwide DAB frequencies, check WorldDMB online at <http://www.worlddab.org/>.
- For details on the antenna connection, see "Connecting the radio antennas" (p.30).

## Preparing the DAB tuning

Before tuning into DAB radio stations, follow the procedure below to perform an initial scan.

### 1 Press DAB to select the DAB band.

The following message appears on the front panel if you have not performed an initial scan yet.



### 2 Press ENTER to start an initial scan.



When the initial scan finishes, the unit automatically tunes into the first DAB radio station as stored in station order.



### Note

- If no DAB radio stations are found by an initial scan, the message in Step 1 appears again. Press ENTER to start an initial scan again.
- You can check reception strength of each DAB channel label (p.64).
- To perform an initial scan again after some DAB radio stations are stored, select "Init Scan" (p.87) in the "Option" menu. If you perform an initial scan again, the DAB radio stations currently registered to the preset numbers will be cleared.



## Selecting a DAB radio station for reception

You can select a DAB radio station from the stations stored by the initial scan.

### 1 Press DAB to select the DAB band.

"TUNER" is selected as the input source and then the DAB radio station currently selected is displayed.

### 2 Press TUNING repeatedly to select a DAB radio station.

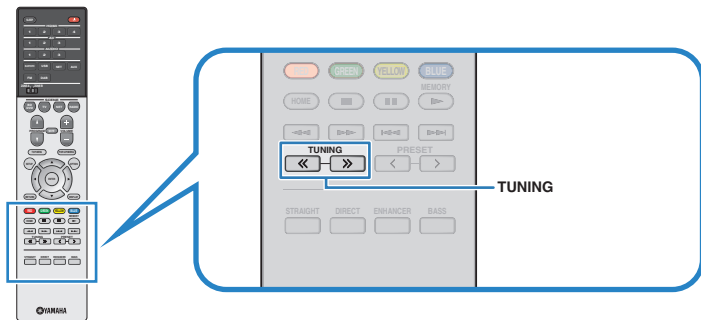

(U.K., Europe, Australia and Russia models)



### Note

- "Off Air" appears when the selected DAB radio station is currently not available.
- When the unit is receiving a secondary station, "2" appears next to "DAB".

#### Secondary station



- You can watch videos input from external devices while listening to radio by selecting the video input jack in "Video Out (Video Out)" (p.90) in the "Option" menu.

## Registering favorite DAB radio stations (presets)

You can register up to 40 DAB radio stations as presets. Once you have registered stations, you can easily tune into them by selecting their preset numbers.

### Note

You can register up to 40 favorite radio stations each for DAB and FM bands.

## ■ Registering a DAB radio station as presets

Select a DAB radio station and register it to a preset number.

**1** Follow “Selecting a DAB radio station for reception” (p.61) to tune into the desired DAB radio station.

**2** Hold down MEMORY for a few seconds.

The first time that you do register a station, the selected radio station will be registered to the preset number “01”. Thereafter, each radio station you select will be registered to the next empty (unused) preset number after the most recently registered number.

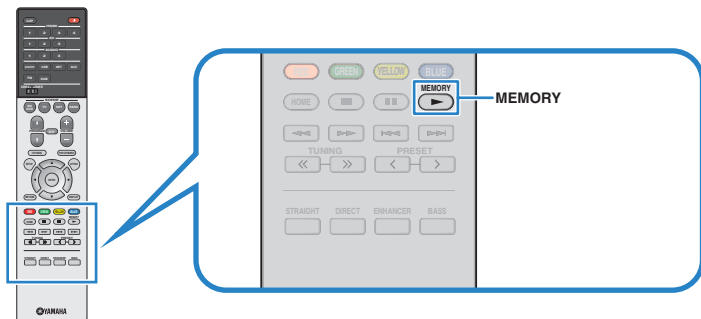

(U.K., Europe, Australia and Russia models)



Preset number

### Note

To select a preset number for registering, press MEMORY once after tuning into the desired radio station, press PRESET to select a preset number, and then press MEMORY again.



“Empty” (not in use) or “Overwrite?” (in use)

## ■ Selecting a preset DAB radio station

Tune into a registered DAB radio station by selecting its preset number.

**1** Press DAB to select “TUNER” as the input source.

**2** Press PRESET repeatedly to select the desired DAB radio station.

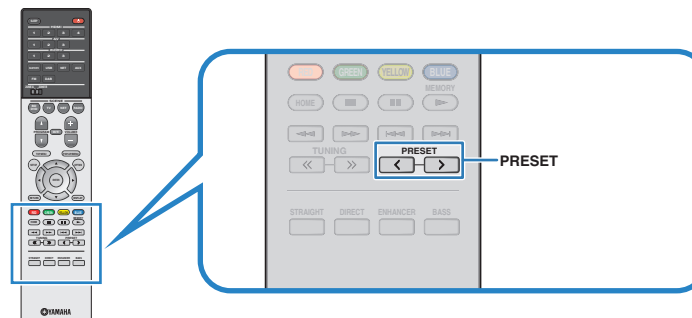

(U.K., Europe, Australia and Russia models)



### Note

“No Presets” appears when no DAB radio stations are registered.

## ■ Clearing preset DAB radio stations

Clear DAB radio stations registered to the preset numbers.

- 1 Press DAB to select “TUNER” as the input source.
- 2 Press OPTION.
- 3 Use the cursor keys to select “Preset” and press ENTER.

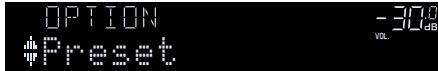

- 4 Use the cursor keys (◀/▶) to select a preset station to be cleared and press ENTER.



Preset station to be cleared

If the preset station is cleared, “Cleared” appears and then the next in-use preset number is displayed.



- 5 Repeat step 4 until all desired preset stations are cleared.
- 6 To exit from the menu, press OPTION.

## Displaying the DAB information

The unit can receive various types of DAB information when it is tuned into a DAB radio station.

- 1 Tune into the desired DAB radio station.
- 2 Press INFO repeatedly to select between the various display items.



Item name

About 3 seconds after a display item is selected, its corresponding information appears.



Information

<b>Service Label</b>	Station name
<b>DLS (Dynamic Label Segment)</b>	Information on the current station
<b>Ensemble Label</b>	Ensemble name
<b>Program Type</b>	Station genre
<b>Date And Time</b>	Current date and time
<b>Audio Mode</b>	Audio mode (monaural/stereo) and bit rate
<b>CH Label/Freq.</b>	Channel label and frequency
<b>Signal Quality</b>	Signal reception quality (0 [none] to 100 [best])
<b>DSP Program</b>	Sound mode name
<b>Audio Decoder</b>	Decoder name

### Note

Some information may not be available depending on the selected DAB radio station.

## Checking reception strength of each DAB channel label

You can check reception strength of each DAB channel label (0 [none] to 100 [best]).

- 1 Press **DAB** to select “**TUNER**” as the input source.
- 2 Press **OPTION**.
- 3 Use the cursor keys to select “**Tune AID**” and press **ENTER**.
- 4 Use the cursor keys (</>) to select the desired DAB channel label.



DAB channel label

Reception strength

- 5 To exit from the menu, press **OPTION**.

## DAB frequency information

The unit supports Band III (174 to 240 MHz) only.

Frequency	Channel label
174.928 MHz	5A
176.640 MHz	5B
178.352 MHz	5C
180.064 MHz	5D
181.936 MHz	6A
183.648 MHz	6B
185.360 MHz	6C
187.072 MHz	6D
188.928 MHz	7A
190.640 MHz	7B
192.352 MHz	7C
194.064 MHz	7D
195.936 MHz	8A
197.648 MHz	8B
199.360 MHz	8C
201.072 MHz	8D
202.928 MHz	9A
204.640 MHz	9B
206.352 MHz	9C
208.064 MHz	9D
209.936 MHz	10A
211.648 MHz	10B
213.360 MHz	10C
215.072 MHz	10D
216.928 MHz	11A
218.640 MHz	11B
220.352 MHz	11C
222.064 MHz	11D
223.936 MHz	12A
225.648 MHz	12B
227.360 MHz	12C
229.072 MHz	12D
230.784 MHz	13A

Frequency	Channel label
232.496 MHz	13B
234.208 MHz	13C
235.776 MHz	13D
237.488 MHz	13E
239.200 MHz	13F

## Listening to FM radio (U.K., Europe, Australia and Russia models)

You can tune into an FM radio station by specifying its frequency or selecting from registered radio stations.

### Selecting a frequency for reception

#### 1 Press FM to select the FM band.

“TUNER” is selected as the input source and then the frequency currently selected is displayed.



#### 2 Press TUNING repeatedly to set a frequency.

Hold down the key for about a second to search stations automatically.

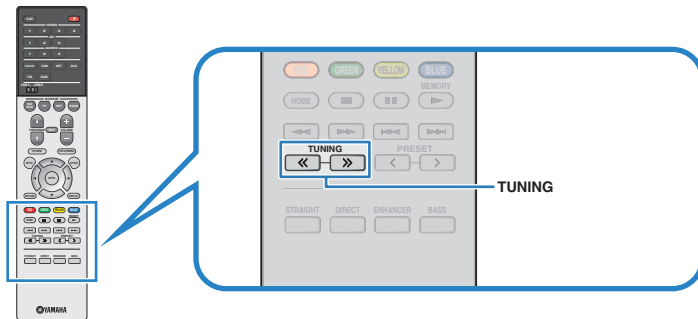

(U.K., Europe, Australia and Russia models)



“TUNED” lights up when the unit is receiving an FM radio station signal.

“STEREO” lights up when the unit is receiving a stereo FM radio signal.

#### Note

- You can switch between “Stereo” (stereo) and “Mono” (monaural) for FM radio reception from “FM Mode” (p.87) in the “Option” menu. When the signal reception for an FM radio station is unstable, switching to monaural may improve it.
- You can watch videos input from external devices while listening to radio by selecting the video input jack in “Video Out (Video Out)” (p.90) in the “Option” menu.

### Registering favorite FM radio stations (presets)

You can register up to 40 FM radio stations as presets. Once you have registered stations, you can easily tune into them by selecting their preset numbers.

#### Note

You can register up to 40 favorite radio stations each for DAB and FM bands.

#### ■ Registering FM radio stations automatically (Auto Preset)

Automatically register FM radio stations with strong signals (up to 40 stations).

#### Note

(U.K. and Europe models only)

Only Radio Data System broadcasting stations are stored automatically by the Auto Preset function.

- 1 Press FM to select “TUNER” as the input source.
- 2 Press OPTION.
- 3 Use the cursor keys to select “Preset” and press ENTER.



#### 4 To start the Auto Preset process, press ENTER.

“SEARCH” appears during Auto Preset



Preset number from which to start the registration

#### Note

- To specify the preset number from which to start the registration, press cursor keys (</>) or PRESET to select a preset number.
- To cancel the Auto Preset process, press RETURN.

When the Auto Preset process finishes, “FINISH” appears and the “Option” menu closes automatically.



## ■ Registering an FM radio station manually

Select an FM radio station manually and register it to a preset number.

**1** Follow “Selecting a frequency for reception” (p.56) to tune into the desired FM radio station.

**2** Hold down MEMORY for a few seconds.

The first time that you do register an FM radio station, the selected radio station will be registered to the preset number “01”. Thereafter, each radio station you select will be registered to the next empty (unused) preset number after the most recently registered number.

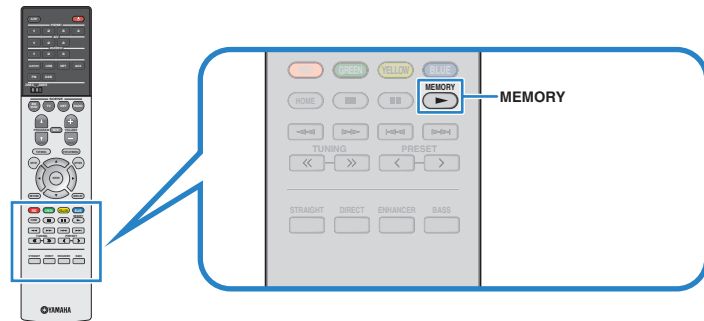

(U.K., Europe, Australia and Russia models)



Preset number

#### Note

To select a preset number for registering, press MEMORY once after tuning into the desired radio station, press PRESET to select a preset number, and then press MEMORY again.



“Empty” (not in use) or the frequency currently registered

## ■ Selecting a preset FM radio station

Tune into a registered FM radio station by selecting its preset number.

- 1 Press FM to select “TUNER” as the input source.
- 2 Press PRESET repeatedly to select the desired FM radio station.

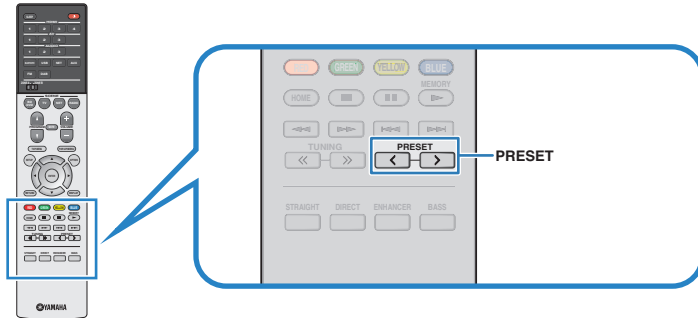

(U.K., Europe, Australia and Russia models)



### Note

“No Presets” appears when no FM radio stations are registered.

## ■ Clearing preset FM radio stations

Clear FM radio stations registered to the preset numbers.

- 1 Press FM to select “TUNER” as the input source.
- 2 Press OPTION.
- 3 Use the cursor keys to select “Preset” and press ENTER.  

- 4 Use the cursor keys ( $\Delta/\nabla$ ) to select “CLEAR”.
- 5 Use the cursor keys ( $\langle/\rangle$ ) to select a preset station to be cleared and press ENTER.



Preset station to be cleared

If the preset station is cleared, “Cleared” appears and then the next in-use preset number is displayed.



- 6 Repeat step 5 until all desired preset stations are cleared.
- 7 To exit from the menu, press OPTION.

## Radio Data System tuning

(U.K. and Europe models only)

Radio Data System is a data transmission system used by FM stations in many countries. The unit can receive various types of Radio Data System data, such as "Program Service", "Program Type", "Radio Text" and "Clock Time", when it is tuned into a Radio Data System broadcasting station.

### ■ Displaying the Radio Data System information

#### 1 Tune into the desired Radio Data System broadcasting station.

##### Note

We recommend using "Auto Preset" to tune into the Radio Data System broadcasting stations (p.57).

#### 2 Press INFO repeatedly to select between the various display items.



Item name

About 3 seconds after a display item is selected, its corresponding information appears.



Information

<b>Program Service</b>	Program service name
<b>Program Type</b>	Current program type
<b>Radio Text</b>	Information on the current program
<b>Clock Time</b>	Current time
<b>DSP Program</b>	Sound mode name
<b>Audio Decoder</b>	Decoder name
<b>Frequency</b>	Frequency

##### Note

"Program Service", "Program Type", "Radio Text", and "Clock Time" are not displayed if the radio station does not provide the Radio Data System service.



## Playing back music stored on a Bluetooth® device

You can play back music files stored on a Bluetooth device (such as smartphones) on the unit. Also, you can enjoy audio played back on the unit using Bluetooth speakers/headphones.

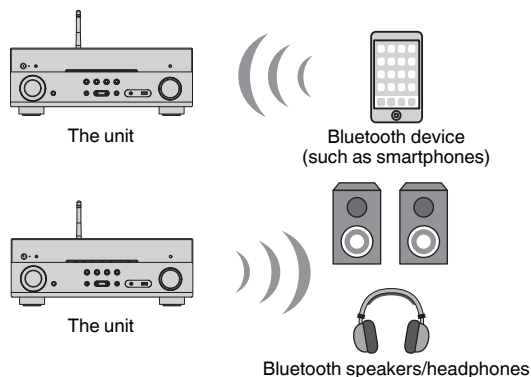

### Note

- To use the BLUETOOTH function, set "Bluetooth" (p.110) in the "Setup" menu to "On".
- You cannot make Bluetooth connections to a Bluetooth device (such as smartphones) and Bluetooth speakers/headphones at the same time.
- For details on supported Bluetooth devices, see "Supported devices and file formats" (p.130).
- Stand the wireless antenna upright for connecting to a Bluetooth device wirelessly. For details, see "Preparing a wireless antenna" (p.31).

## Playback Bluetooth® device music on the unit

Follow the procedure below to establish a Bluetooth connection between a Bluetooth device (such as smartphones) and the unit, and play back music stored the Bluetooth device on the unit.

### Note

The unit does not support video playback via Bluetooth.

- 1 Press BLUETOOTH to select "Bluetooth" as the input source.**
- 2 On the Bluetooth device, select the unit (network name of the unit) from the available device list.**

A connection between the Bluetooth device and the unit will be made.  
If the pass key is required, enter the number "0000".
- 3 On the Bluetooth device, select a song and start playback.**

The playback screen (artist name, album name and song title) is displayed on the TV.

### Note

- If the unit detects the Bluetooth device previously connected, the unit automatically connects to the Bluetooth device after Step 1. To establish another Bluetooth connection, first terminate the current Bluetooth connection.
- To terminate the Bluetooth connection, perform one of the following operations.
  - Perform the disconnect operation on the Bluetooth device.
  - Select an input source other than "Bluetooth" on the unit.
  - Select "Disconnect" in "Audio Receive" (p.92) in the "Setup" menu.
- You can use the external device operation keys (▶, ■, ■■, ◀◀, ▶▶) on the remote control to control playback.

## Enjoying audio using Bluetooth® speakers/ headphones

---

Follow the procedure below to establish a Bluetooth connection between Bluetooth speakers/headphones and the unit.

**1 Use the input selection keys on the remote control to select an input source.**

Select an input source other than Bluetooth.

**2 Press SETUP.**

**3 Use the cursor keys to select “Bluetooth” and press ENTER.**

**4 Use the cursor keys to set “Bluetooth” to “On”, and then set “Transmitter” to “On” in the same way.**

**5 Use the cursor keys to select “Device Search” to search the Bluetooth devices.**

The list of Bluetooth devices is displayed.

**6 Select the Bluetooth speakers/headphones to be connected with the unit and press ENTER.**

When the connection process finishes, audio played back on the unit will be reproduced from the Bluetooth speakers/headphones.

**Note**

- If the desired Bluetooth device is not displayed on the list, set the Bluetooth device to the pairing mode and then select “Device Search”.
- Follow one of the procedures below to terminate the Bluetooth connection.
  - Perform the disconnect operation on the Bluetooth speakers/headphones.
  - Press the SETUP key, then use the cursor keys to select “Bluetooth”, then “Transmitter”, and then “Off”.

## Playing back music with AirPlay

The AirPlay function allows you to play back iTunes or iPhone/iPad/iPod touch music on the unit via network.

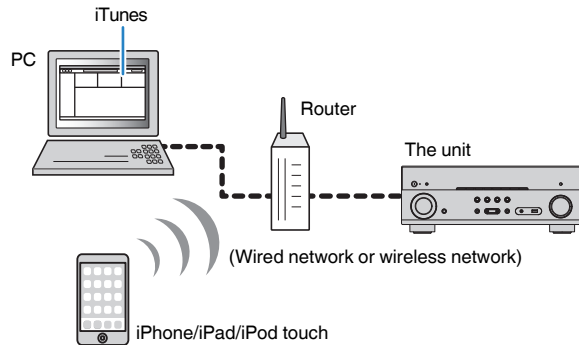

### Note

- To use this function, the unit and your PC or iPhone must be connected to the same router (p.31). You can check whether the network parameters (such as the IP address) are properly assigned to the unit in "Information" (p.108) in the "Setup" menu.
- If the iPhone does not recognize the unit, check your network environment (p.31).
- For details on supported iPhone devices, see "Supported devices and file formats" (p.130).

## Playback of iTunes/iPhone music contents

Follow the procedure below to play back iTunes/iPhone music contents on the unit.

### 1 Turn on the unit, and start iTunes on the PC or display the playback screen on the iPhone.

If the iTunes/iPhone recognizes the unit, the AirPlay icon appears.

iOS 10 (example)



iOS 9 (example)

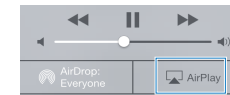

iTunes (example)



### Note

If the icon does not appear, check whether the unit and PC/iPhone are connected to the router properly.

### 2 On the iTunes/iPhone, click (tap) the AirPlay icon and select the unit (network name of the unit) as the audio output device.

### 3 Select a song and start playback.

The unit automatically selects "AirPlay" as the input source and starts playback.

The playback screen is displayed on the TV.

## Note

- The playback screen is available only when your TV is connected to the unit via HDMI.
- You can turn on the unit automatically when starting playback on iTunes or iPhone by setting "Network Standby" (p.109) in the "Setup" menu to "On".
- You can edit the network name (the unit's name on the network) displayed on iTunes/iPhone in "Network Name" (p.110) in the "Setup" menu.
- You can adjust the unit's volume from the iTunes/iPhone during playback. To disable volume controls from iTunes/iPhone, set "Volume Interlock (Vol.Interlock)" (p.90) in the "Option" menu to "Off".

## Notice

- When you use iTunes/iPhone controls to adjust volume, the volume may be unexpectedly loud. This could result in damage to the unit or speakers. If the volume suddenly increases during playback, stop playback on the iTunes/iPhone immediately.

## Playback screen

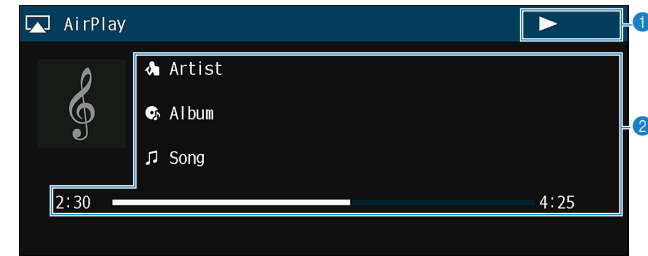

### 1 Playback indicator

### 2 Playback information

Displays the artist name, album name, song title, and elapsed time/song length.

Use the following remote control keys to control playback.

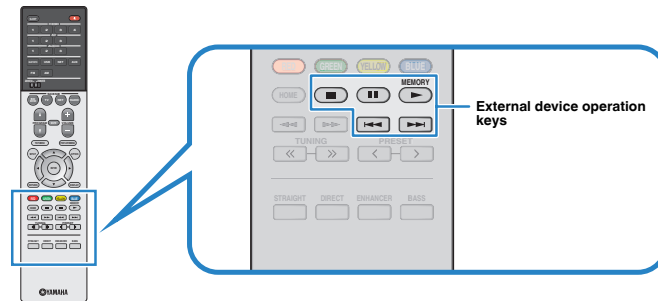

External device operation keys	Function
	Resumes playback from pause.
	Stops playback.
	Stops playback temporarily.
	Skips forward/backward.

# Playing back music stored on a USB storage device

You can play back music files stored on a USB storage device on the unit.

## Note

For details on playable USB devices, see “Supported devices and file formats” (p.130).

## Connecting a USB storage device

### 1 Connect the USB storage device to the USB jack.

The unit (front)

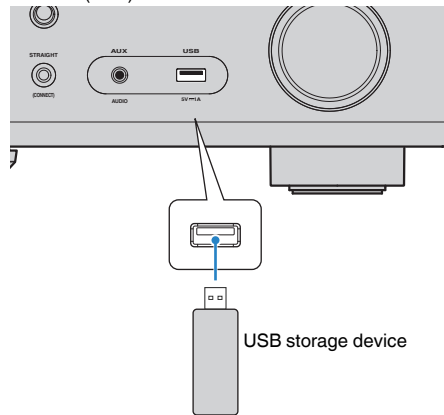

## Note

- If the USB storage device contains many files, it may take time to load them. In this case, “Loading...” appears in the front display.
- Stop playback of the USB storage device before disconnect it from the USB jack.
- Connect a USB storage device directly to the USB jack of the unit. Do not use extension cables.
- The unit cannot charge USB devices while it is in standby mode.

## Playback of USB storage device contents

Follow the procedure below to operate the USB storage device contents and start playback.

You can control the USB memory device with the menu displayed on the TV screen.

## Note

- Operations with TV screen are available only when your TV is connected to the unit via HDMI.
- “\_” (underscore) will be displayed for characters not supported by the unit.

### 1 Press USB to select “USB” as the input source.

The browse screen (p.74) is displayed on the TV.

## Note

If playback is ongoing on your USB storage device, the playback screen is displayed.

### 2 Use the cursor keys to select an item and press ENTER.

If a song is selected, playback starts and the playback screen (p.74) is displayed.

## Note

- To return to the previous screen, press RETURN.
- To return to the top level while on the browse screen, hold down RETURN.
- To switch the screen mode browse/playback/off, press DISPLAY.
- Files not supported by the unit cannot be selected.

## Browse screen

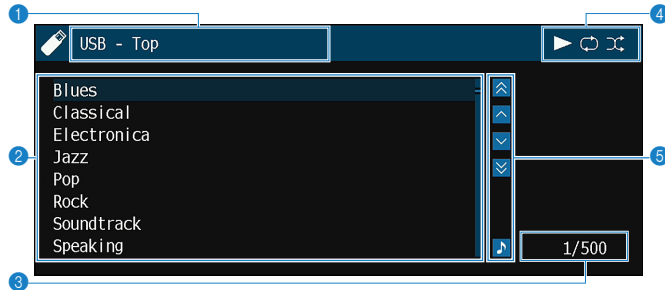

- 1 **List name**
- 2 **Contents list**  
Displays the list of USB storage device contents. Use the cursor keys to select an item and press ENTER to confirm the selection.
- 3 **Item number/total**
- 4 **Status indicators**  
Display the current shuffle/repeat settings (p.75) and playback status (such as play/pause).
- 5 **Operation menu**  
Press the cursor key (▷) and then use the cursor keys (△/▽) to select an item. Press ENTER to confirm the selection.

Icon	Function
	Moves 10 pages backward.
	Moves to the previous page of the list.
	Moves to the next page of the list.
	Moves 10 pages forward.
	Moves to the playback screen.

### Note

A content selected by the cursor is displayed on the front display.

## Playback screen

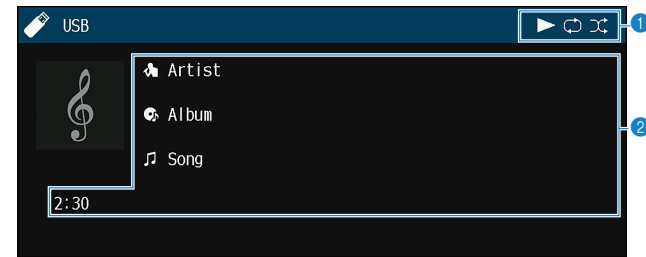

- 1 **Status indicators**  
Display the current shuffle/repeat settings (p.75) and playback status (such as play/pause).
- 2 **Playback information**  
Displays the artist name, album name, song title, and elapsed time.

Use the following remote control keys to control playback.

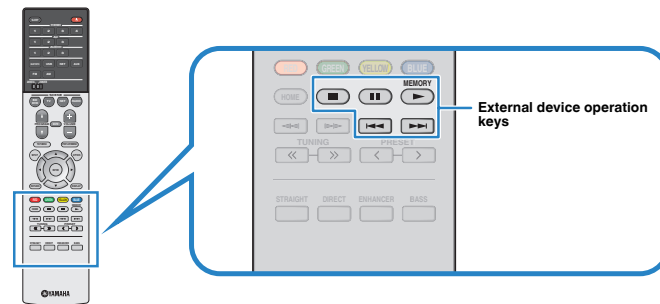

External device operation keys	Function
	Resumes playback from pause.
	Stops playback.
	Stops playback temporarily.
	Skips forward/backward.

### Note

A content name of a current playback is displayed on the front display. To switch the displayed item, press INFO (p.49).

## ■ Shuffle/repeat settings

You can configure the shuffle/repeat settings for playback of USB storage device contents.



**1** When “USB” is selected as the input source, press **OPTION**.

**2** Use the cursor keys to select “Shuffle” (Shuffle) or “Repeat” (Repeat) and press **ENTER**.

### Note

- To return to the previous screen during menu operations, press **RETURN**.
- Texts in parentheses denote indicators on the front display.

**3** Use the cursor keys (</>) to select a setting.

Item	Setting	Function
<b>Shuffle</b> <b>(Shuffle)</b>	Off (Off)	Turns off the shuffle function.
	On (On)	Plays back songs in the current album (folder) in random order. “  ” appears on the TV screen.
<b>Repeat</b> <b>(Repeat)</b>	Off (Off)	Turns off the repeat function.
	One (One)	Plays back the current song repeatedly. “  ” appears on the TV screen.
	All (All)	Plays back all songs in the current album (folder) repeatedly. “  ” appears on the TV screen.

**4** To exit from the menu, press **OPTION**.

## Playing back music stored on media servers (PCs/NAS)

You can play back music files stored on your PC or DLNA-compatible NAS on the unit.

### Note

- To use this function, the unit and your PC must be connected to the same router (p.31). You can check whether the network parameters (such as the IP address) are properly assigned to the unit in “Information” (p.108) in the “Setup” menu.
- The audio may be interrupted while using the wireless network connection. In this case, use the wired network connection.
- For details on playable file formats, see “Supported devices and file formats” (p.130).

## Media sharing setup

To play back music files stored on your PC or DLNA-compatible NAS, first you need to configure the media sharing setting on each music server.

### ■ For a PC with Windows Media Player 12 installed

- 1 Start Windows Media Player 12 on your PC.**
- 2 Select “Stream”, then “Turn on media streaming”.**
- 3 Click “Turn on media streaming”.**
- 4 Select “Allowed” from the drop-down list next to the unit’s model name.**
- 5 Click “OK” to exit.**

### Note

For details on media sharing settings, refer to Windows Media Player help.

### ■ For a PC or a NAS with other DLNA server software installed

Refer to the instruction manual for the device or software and configure the media sharing settings.



## Playback of PC music contents

Follow the procedure below to operate the PC music contents and start playback. You can control the PC/NAS with the menu displayed on the TV screen.

### Note

- Operations with TV screen are available only when your TV is connected to the unit via HDMI. If not, carry out operations while viewing the front display.
- “\_” (underscore) will be displayed for characters not supported by the unit.

### 1 Press NET repeatedly to select “SERVER” as the input source.

The browse screen (p.77) is displayed on the TV.

#### Note

If playback of a music file selected from the unit is ongoing on your PC, the playback screen is displayed.

### 2 Use the cursor keys to select a music server and press ENTER.

### 3 Use the cursor keys to select an item and press ENTER.

If a song is selected, playback starts and the playback screen (p.78) is displayed.

#### Note

- To return to the previous screen, press RETURN.
- To return to the top level while on the browse screen, hold down RETURN.
- To switch the screen mode browse/playback/off, press DISPLAY.
- Files not supported by the unit cannot be selected.

## Browse screen

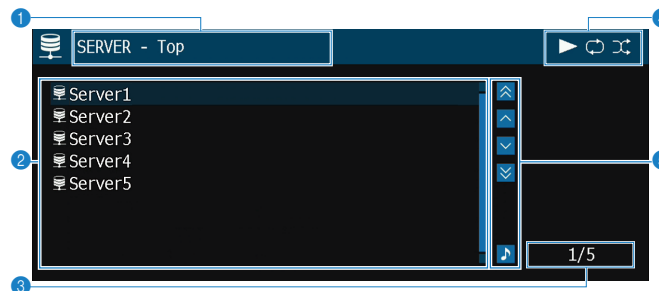

#### 1 List name

#### 2 Contents list

Displays the list of PC content. Use the cursor keys to select an item and press ENTER to confirm the selection.

#### 3 Item number/total

#### 4 Status indicators

Display the current shuffle/repeat settings (p.78) and playback status (such as play/pause).

#### 5 Operation menu

Press the cursor key (>) and then use the cursor keys (Δ/∇) to select an item. Press ENTER to confirm the selection.

Icon	Function
	Moves 10 pages backward.
	Moves to the previous page of the list.
	Moves to the next page of the list.
	Moves 10 pages forward.
	Moves to the playback screen.

## ■ Playback screen

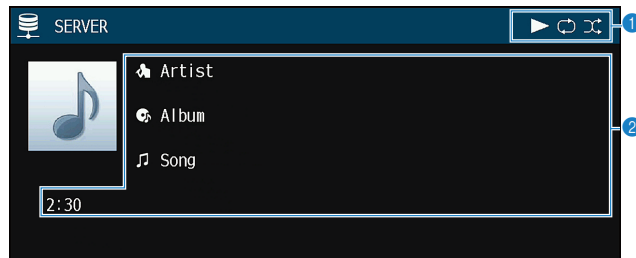

### 1 Status indicators

Display the current shuffle/repeat settings (p.78) and playback status (such as play/pause).

### 2 Playback information

Displays the artist name, album name, song title, and elapsed time.

Use the following remote control keys to control playback.

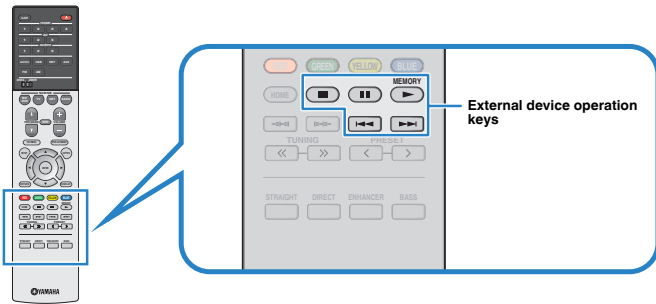

External device operation keys	Function
	Resumes playback from pause.
	Stops playback.
	Stops playback temporarily.
	Skips forward/backward.

### Note

You can also use a DLNA-compatible Digital Media Controller (DMC) to control playback. For details, see "DMC Control" (p.109).

## ■ Shuffle/repeat settings

You can configure the shuffle/repeat settings for the playback of PC music content.

- 1 When "SERVER" is selected as the input source, press **OPTION**.
- 2 Use the cursor keys to select "Shuffle" (Shuffle) or "Repeat" (Repeat) and press **ENTER**.

### Note

- To return to the previous screen during menu operations, press **RETURN**.
- Text in parentheses denotes indicators on the front display.

- 3 Use the cursor keys (</>) to select a setting.

Item	Setting	Function
<b>Shuffle (Shuffle)</b>	Off (Off)	Turns off the shuffle function.
	On (On)	Plays back songs in the current album (folder) in random order. "⌘" appears on the TV screen.
<b>Repeat (Repeat)</b>	Off (Off)	Turns off the repeat function.
	One (One)	Plays back the current song repeatedly. "↺" appears on the TV screen.
	All (All)	Plays back all songs in the current album (folder) repeatedly. "↻" appears on the TV screen.

- 4 To exit from the menu, press **OPTION**.

## Listening to Internet radio

You can listen to Internet radio stations from all over the world.

### Note

- Operations with TV screen are available only when your TV is connected to the unit via HDMI. If not, carry out operations while viewing the front display.
- To use this function, the unit must be connected to the Internet (p.31). You can check whether the network parameters (such as the IP address) are properly assigned to the unit in "Information" (p.108) in the "Setup" menu.
- You may not be able to receive some Internet radio stations.
- The unit uses the `airable.Radio service`. `airable` is a service of Tune In GmbH.
- This service may be discontinued without notice.
- Folder names are different depending on the language.

## Playback of Internet radio

Follow the procedure below to select an Internet radio station and start playback.

You can control the Internet radio with the menu displayed on the TV screen.

### 1 Press NET repeatedly to select "NET RADIO" as the input source.

The browse screen (p.79) is displayed on the TV.

### 2 Use the cursor keys to select an item and press ENTER.

If an Internet radio station is selected, playback starts and the playback screen (p.80) is displayed.

### Note

- To return to the previous screen, press RETURN.
- To return to the top level while on the browse screen, hold down RETURN.
- To switch the screen mode browse/playback/off, press DISPLAY.

## Browse screen

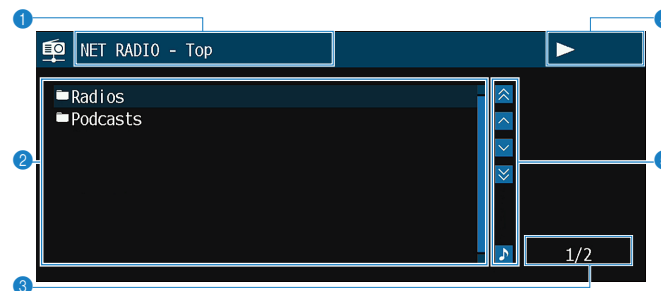

#### 1 List name

#### 2 Contents list

Displays the list of Internet radio content. Use the cursor keys to select an item and press ENTER to confirm the selection.

#### 3 Item number/total

#### 4 Playback indicator

#### 5 Operation menu

Press the cursor key (▷) and then use the cursor keys (△/▽) to select an item. Press ENTER to confirm the selection.

Icon	Function
	Moves 10 pages backward.
	Moves to the previous page of the list.
	Moves to the next page of the list.
	Moves 10 pages forward.
	Moves to the playback screen.

## ■ Playback screen

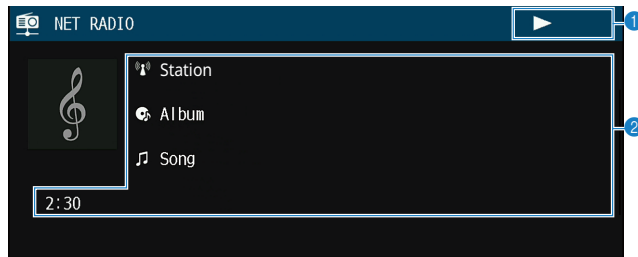

- ① **Playback indicator**
- ② **Playback information**

Displays the station name, album name, song title, and elapsed time.

### Note

- Use the external device operation key (■) to stop playback.
- Some information may not be available depending on the station.

## ■ Registering favorite Internet radio stations

You can register your favorite Internet radio stations to the “Favorites” folder.

### Note

You can also register up to 40 favorite USB, Bluetooth and network contents as shortcuts (p.85).

## ■ Registering the station with the Option menu

Follow the procedure below to register your favorite station to the “Favorites” folder.

- 1 While listening to Internet radio, press OPTION.**
- 2 Use the cursor keys to select “Add to favorites” and press ENTER.**

### Note

- On the playback screen, the current station is added to the “Favorites” folder. On the browse screen, the station selected in the list is added to the “Favorites” folder.
- Radio stations registered to favorites are displayed with “★”.
- To remove a station that is registered to favorites, select the station and then select “Remove from favorites”.

## Playing back more high-quality sounds with bi-amp connections

Using the four internal amplifiers for front speakers allows you to have more high-quality sounds.

For example, you can use 2-way bi-amp speakers with a woofer and tweeter for front speakers. It produces expansive sound in a bi-amp system featuring a woofer and tweeter. By directly driving each speaker individually, it produces powerful sound while maintaining the feeling of a high S/N ratio.

### Note

When using the four internal amplifiers in bi-amp system, the unit supports only 2- to 5.1-channel speaker system.

## Connecting front speakers that support bi-amp connections

When using front speakers that support bi-amp connections, connect them to the FRONT terminals and SURROUND BACK/PRESENCE/BI-AMP/ZONE B terminals.

To enable the bi-amp function, set "Power Amp Assign" (p.94) in the "Setup" menu to "BI-AMP" after connecting the power cable to an AC wall outlet.

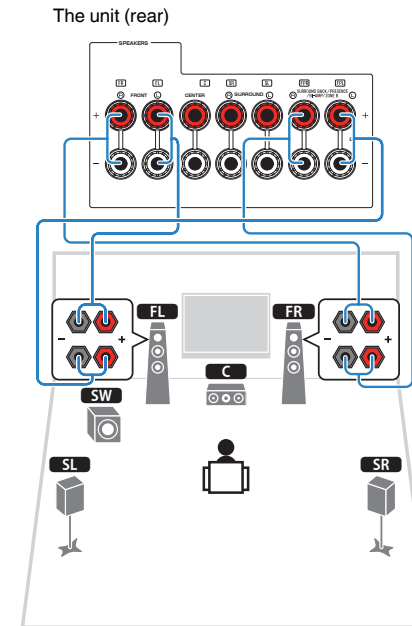

### Note

- Surround back speakers, presence speakers, bi-amp speakers or Zone B speakers cannot be connected simultaneously.
- The FRONT terminals and SURROUND BACK/PRESENCE/BI-AMP/ZONE B terminals output the same signals.

### Notice

- Before making bi-amp connections, remove any brackets or cables that connect a woofer with a tweeter. Refer to the instruction manual of the speakers for details. If you are not making bi-amp connections, make sure that the brackets or cables are connected before connecting the speaker cables.

## Playing back music in multiple rooms

The Zone A/B function allows you to play back an input source in the room where the unit is installed (Zone A) and in another room (Zone B).

For example, you can turn on Zone A (turn off Zone B) when you are in the living room, and turn on Zone B (turn off Zone A) when you are in the study room. Also, you can turn on both zones when you want to enjoy the same input source in those rooms simultaneously.

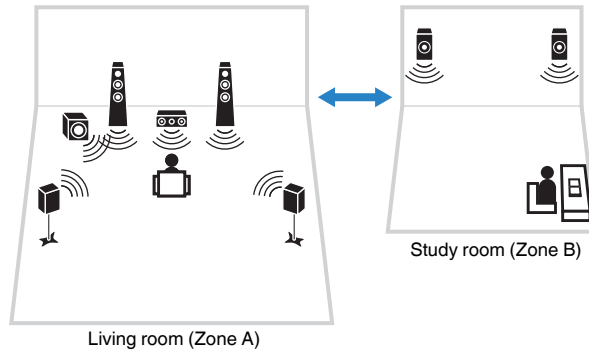

### Note

- Multichannel sources are mixed down to 2 channels and output to the Zone B.
- The same input source is applied to both Zone A and Zone B.
- By default, the volume for Zone B changes in conjunction with the volume for Zone A. If there is volume difference between Zone A/B, you can correct it in "ZoneB Trim" in the "Option" menu (p.84). Also, you can adjust the volume for Zone B separately (p.84).
- You can automatically enable/disable the audio output to Zone A/B in conjunction with a scene selection (p.50)

## Connecting Zone B speakers

Connect the device that will be used in Zone B to the unit.

### Notice

- Remove the unit's power cable from the AC wall outlet before connecting speakers.
- Ensure that the bare wires of the speaker cable do not touch one another or come into contact with the unit's metal parts. Doing so may damage the unit or the speakers. If the speaker cables short circuit, "Check SP Wires" will appear on the front display when the unit is turned on.

Connect the speakers placed in Zone B to the unit with speaker cables.

To utilize the SURROUND BACK/PRESENCE/BI-AMP/ZONE B terminals for Zone B speakers, set "Power Amp Assign" (p.94) in the "Setup" menu to "Zone B" after connecting the power cable to an AC wall outlet.

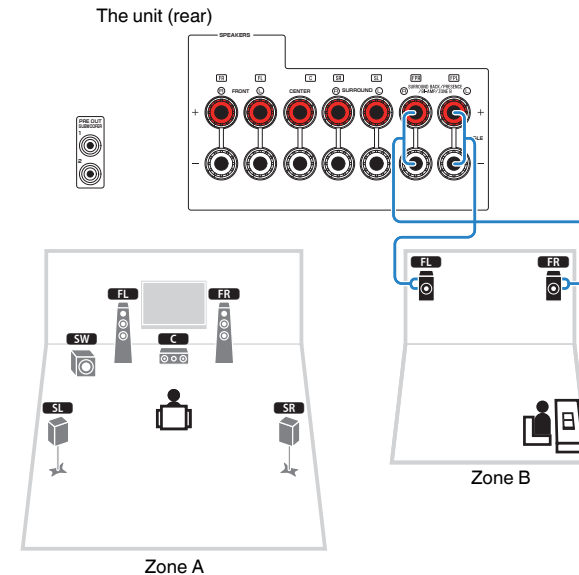

### Note

Surround back speakers, presence speakers, bi-amp speakers or Zone B speakers cannot be connected simultaneously.

## Operating the Zone B

### Basic playback procedure

- 1 Slide the Zone switch to “ZONE B”.

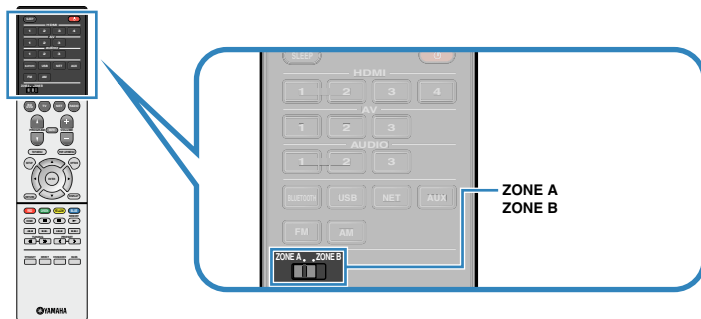

- 2 Press **⏻** (receiver power).

Each time you press the key, the ZONE B audio output is on or off.

“ZONE B” lights up



- 3 Use the input selection keys to select an input source.

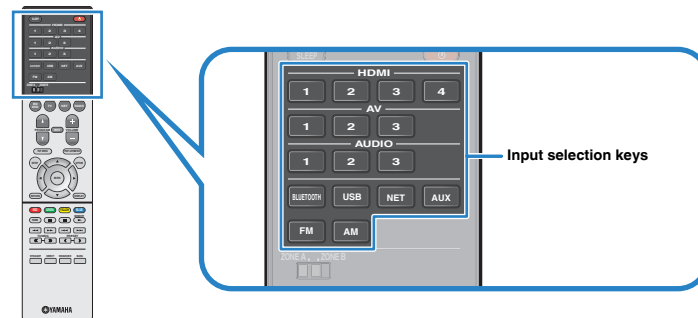

- 4 Start playback on the external device or select a radio station.

- 5 Press **VOLUME** to adjust the volume.

#### Note

To adjust the volume for Zone B separately, see “Adjusting the volume for Zone B separately” (p.84).

## ■ Correcting volume difference between Zone A and Zone B

If you are bothered by volume difference between Zone A/B, follow the procedure below to adjust the volume for Zone B.

### 1 Press **OPTION**.

#### Note

Slide the Zone switch to "ZONE A" in menu operations.

### 2 Use the cursor keys to select "Volume Trim" (Volume Trim) and press **ENTER**.

#### Note

- To return to the previous screen during menu operations, press RETURN.
- Text in parentheses denotes indicators on the front display.

### 3 Use the cursor keys ( $\Delta/\nabla$ ) to select "ZoneB Trim" (ZB.Trim) and the cursor keys ( $\leftarrow/\rightarrow$ ) to adjust the setting.

#### Setting range

-10.0 dB to +10.0 dB (0.5 dB increments)

#### Default

0.0 dB

### 4 To exit from the menu, press **OPTION**.

#### Note

This setting is not effective when "ZoneB Volume" (p.103) in the "Setup" menu is set to "Async".

## ■ Adjusting the volume for Zone B separately

You can separately adjust the volume for Zone B using the remote control when "ZoneB Volume" (p.103) in the "Setup" menu is set to "Async".

### 1 Slide the Zone switch to "ZONE B".

### 2 Press **VOLUME** to adjust the volume for Zone B.

#### Note

To mute the audio output to Zone B, press MUTE.



## Useful functions

### Registering favorite items (shortcut)

You can register up to 40 favorite USB, Bluetooth and network contents as shortcuts and access them directly by selecting the shortcut numbers.

#### Note

- You can also use the “Favorites” feature to register Internet radio stations (p.80).
- The unit registers Bluetooth or AirPlay as an input source. No individual content can be registered.

### Registering an item

Select a desired item and register it to a shortcut number.

- 1 Play back a song or a radio station to be registered.
- 2 Hold down MEMORY for 3 seconds.

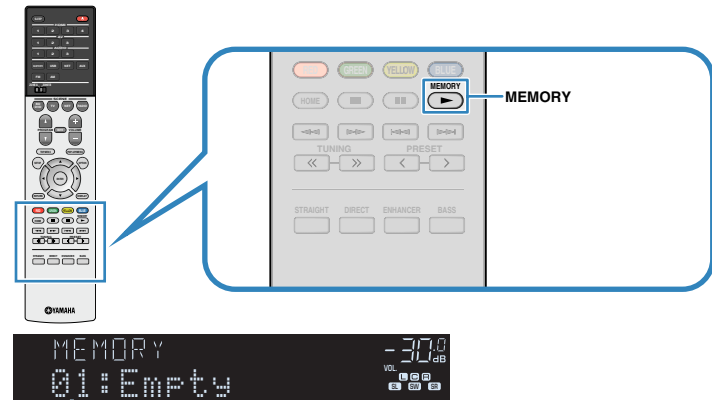

Shortcut number (flashes)

#### Note

To change a shortcut number to which the item will be registered, use PRESET to select the shortcut number after step 2.



“Empty” (not in use) or item currently registered

- 3 To confirm the registration, press MEMORY.

## ■ Recalling a registered item

Recall a registered item by selecting the shortcut number.

### 1 Press BLUETOOTH, NET or USB.

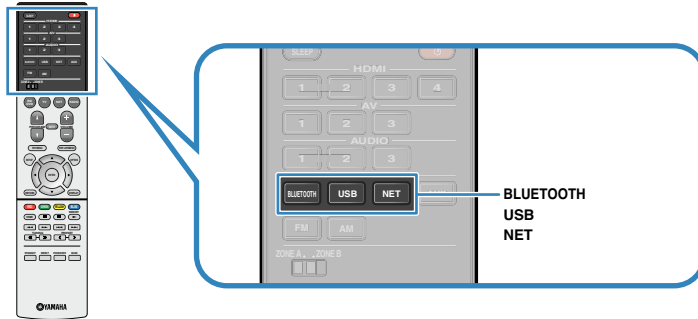

### 2 Press PRESET repeatedly to select a desired item.

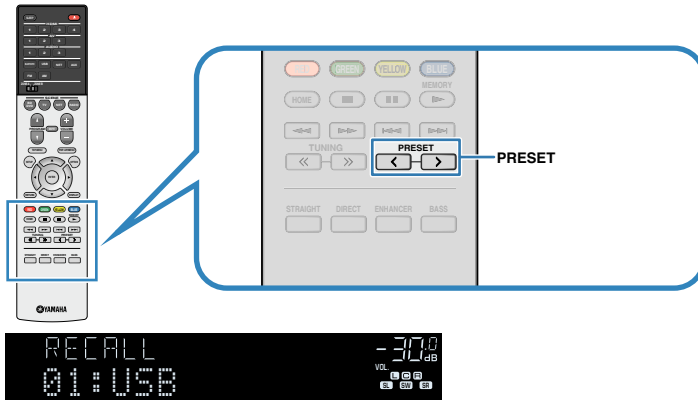

### Note

- "No Presets" appears when no items are registered.
- The registered item cannot be recalled in the following cases.
  - A USB storage device which contains the registered item is not connected to this unit.
  - A PC which contains the registered item is turned off or not connected to the network.
  - The registered network content is temporarily unavailable or out of service.
  - The registered item (file) has been deleted or moved to another location.
  - A Bluetooth connection cannot be established.
- When you register music files stored on a USB storage device or a PC, this unit memorizes the relative position of the music files in the folder. If you have added or deleted any music files to or from the folder, this unit may not recall the music file correctly. In such cases, register the items again.
- The registered content (songs and Internet radio stations) can be displayed as a list and easily recalled by using MusicCast CONTROLLER (p.47) on your mobile device.

# Configuring playback settings for different playback sources (Option menu)

You can configure separate playback settings for different playback sources. This menu is available on the front panel (or on the TV screen), allowing you to easily configure settings during playback.

## 1 Press OPTION.



Front display

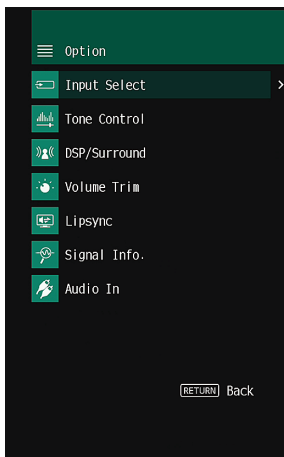

TV screen

## 2 Use the cursor keys to select an item and press ENTER.

### Note

To return to the previous screen during menu operations, press RETURN.

## 3 Use the cursor keys (<|/>) to select a setting.

## 4 To exit from the menu, press OPTION.

## Option menu items

### Note

- Available items vary depending on the selected input source.
- Text in parentheses denotes indicators on the front display.
- Default settings are underlined.
- Depending on the region of purchase, some menu items for audio streaming services are also available. For details, refer to each manual on the supplied CD-ROM.

Item	Function	Page	
<b>Input Select (Input Select)</b>	Switches the input source.	p.88	
<b>Tone Control (Tone Control)</b>	Adjusts the level of high-frequency range and low-frequency range individually.	p.88	
<b>DSP/Surround (DSP/Surround)</b>	<b>Program (PRG)</b>	Select the sound programs and stereo playback.	p.52
	<b>Sur.Decode (SrDec)</b>	Select which surround decoder is used when Sur.Decode is selected as the program.	p.54
	<b>DSP Level (DSP Level)</b>	Adjusts the sound field effect level.	p.88
	<b>Adaptive DRC (A.DRC)</b>	Sets whether the dynamic range (from maximum to minimum) is automatically adjusted when the volume is adjusted.	p.88
	<b>Enhancer (Enhancer)</b>	Enables/disables Compressed Music Enhancer.	p.89
<b>Volume Trim (Volume Trim)</b>	<b>Input Trim (In.Trim)</b>	Corrects volume differences between input sources.	p.89
	<b>Subwoofer Trim (SW.Trim)</b>	Fine-adjusts the subwoofer volume.	p.89
	<b>ZoneB Trim (ZB.Trim)</b>	Corrects volume differences between Zone A/B.	p.84
<b>Lipsync (Lipsync)</b>	Enables/disables the "Lipsync" setting in the "Setup" menu.	p.89	
<b>Signal Info. (Signal Info.)</b>	Displays information about the video/audio signal.	p.89	
<b>Audio In (Audio In)</b>	Combines the video jack of the selected input source with an audio jack of others.	p.90	
<b>Video Out (Video Out)</b>	Selects a video to be output with the selected audio source.	p.90	
<b>FM Mode (FM Mode)</b>	Switches between "Stereo" and "Mono" for FM radio reception.	p.56, p.65	

Item	Function	Page
<b>Preset (Preset)</b>	<b>Auto Preset</b>	Automatically registers FM radio stations with strong signals as presets. p.57, p.65
	<b>Clear Preset</b>	Clear radio stations registered to preset numbers. p.59, p.63, p.67
<b>Shuffle (Shuffle)</b>	Configures the shuffle setting for the USB storage device (p.75) or media server (p.78).	—
<b>Repeat (Repeat)</b>	Configures the repeat setting for the USB storage device (p.75) or media server (p.78).	—
<b>Volume Interlock (Vol.Interlock)</b>	Enables/disables volume controls from iTunes/iPhone via AirPlay.	p.90
<b>Add to favorites (Add to Fav.)</b>	Adds your favorite Internet radio station to the "Favorites" folder, or removes it from the "Favorites" folder.	p.80
<b>Remove from favorites (RemovefromFav.)</b>		
<b>Init Scan (Init Scan)</b>	(U.K., Europe, Australia and Russia models) Performs an initial scan for DAB radio reception.	p.60
<b>Tune AID (Tune AID)</b>	(U.K., Europe, Australia and Russia models) Checks reception strength of each DAB channel.	p.64

## ■ Input Select (Input Select)

Switches the input source. Press ENTER to switch to the selected input source.

## ■ Tone Control (Tone Control)

Adjusts the level of high-frequency range (Treble) and low-frequency range (Bass) individually.

### Choices

Treble (Treble), Bass (Bass)

### Setting range

-6.0 dB to 0.0 dB to +6.0 dB (0.5 dB increments)

### Note

- When both "Treble" and "Bass" are 0.0 dB, "Bypass" appears.
- You can also adjust the tone with the front panel controls. Press TONE CONTROL to select "Treble" or "Bass", then press PROGRAM to make an adjustment.
- If you set an extreme value, sounds may not match those from other channels.

## ■ DSP/Surround (DSP/Surround)

Configures the sound field program and surround settings.

### DSP Level (DSP Level)

Adjusts the sound field effect level.

### Setting range

-6 dB to 0 dB to +3 dB (1 dB increments)

### Adaptive DRC (A.DRC)

Sets whether the dynamic range (from maximum to minimum) is automatically adjusted when the volume level is adjusted. When it is set to "On", it is useful for listening to playback at a low volume at night.

### Settings

On (On)	Automatically adjusts the dynamic range.
---------	--

Off (Off)	The dynamic range is not automatically adjusted.
-----------	--

If "On" is selected, the dynamic range becomes narrow at a low volume and wide at a high volume.

## Enhancer (Enhancer)

Enables/disables Compressed Music Enhancer (p.55).

### Note

- This setting is applied separately to each input source.
- You can also use ENHANCER on the remote control to enable/disable Compressed Music Enhancer (p.55).

### Settings

Off (Off)	Disables Compressed Music Enhancer.
On (On)	Enables Compressed Music Enhancer.

### Default

TUNER, (network sources), AirPlay, SERVER, NET RADIO, Bluetooth, USB: On (On)

Others: Off (Off)

## Volume Trim (Volume Trim)

Fine-adjusts volume difference between input sources or subwoofer volume.

### Input Trim (In.Trim)

Corrects volume differences between input sources. If you are bothered by volume differences when switching between input sources, use this function to correct it.

### Note

This setting is applied separately to each input source.

### Setting range

-6.0 dB to 0.0 dB to +6.0 dB (0.5 dB increments)

### Subwoofer Trim (SW.Trim)

Fine-adjusts the subwoofer volume.

### Setting range

-6.0 dB to 0.0 dB to +6.0 dB (0.5 dB increments)

## Lipsync (Lipsync)

Enables/disables the adjustment configured in "Lipsync" (p.101) in the "Setup" menu.

### Note

This setting is applied separately to each input source.

### Settings

Off (Off)	Disables the "Lipsync" adjustment.
On (On)	Enables the "Lipsync" adjustment.

## Signal Info. (Signal Info.)

Displays information about the video/audio signal.

### Choices

Format (FORMAT)	Audio format of the input signal
Channel (CHANNEL)	The number of source channels in the input signal (front/surround/LFE) For example, "3/2/0.1" means 3 front channels, 2 surround channels, and LFE. For example, "7.1.4" denotes "standard 7.1-channel plus 4 for overhead speaker channels".
Sampling (SAMPLING)	The number of samples per second of the input digital signal
Video In (VIDEO IN)	Type and resolution of the input digital signal
Video Out (VIDEO OUT)	Type and resolution of the output digital signal

### Note

To switch the information on the front display, press the cursor keys ( $\Delta/\nabla$ ) repeatedly.

## ■ Audio In (Audio In)

Combines the video jack of the selected input source with an audio jack of others. For example, use this function in the following cases.

- Connecting a playback device that supports HDMI video output, but not HDMI audio output

### Input sources

HDMI 1-4, AV 1-3

### Settings

AV 1-3, AUDIO 1-3

### Setup procedure

See "Changing the combination of video/audio input jacks" (p.28).

## ■ Video Out (Video Out)

Selects a video to be output with the selected audio source. For example, you can watch the video while listening to the radio.

### Input sources

AUX, AUDIO 1-3, TUNER, (network sources), AirPlay, MusicCast Link, SERVER, NET RADIO, Bluetooth, USB

### Settings

<u>Off(Off)</u>	Does not output video.
HDMI 1-4, AV 1-3	Outputs video input through the corresponding video input jacks.

## ■ Volume Interlock (Vol.Interlock)

Enables/disables volume controls from iTunes/iPhone via AirPlay.

### Settings

Off (Off)	Disables volume controls from iTunes/iPhone.
<u>Limited(Ltd)</u>	Enables volume controls from iTunes/iPhone within the limited range (-80 dB to -20 dB and mute).
Full (Full)	Enables volume controls from iTunes/iPhone in the full range (-80 dB to +16.5 dB and mute).

# CONFIGURATIONS

## Configuring various functions (Setup Menu)

You can configure the unit's various function with the menu displayed on the TV screen.

### Note

- Operations with TV screen are available only when your TV is connected to the unit via HDMI. If not, carry out operations while viewing the front display.
- If new firmware is available, the message screen appears. For details, see "Updating the unit's firmware via the network" (p.115).
- If new firmware is available, the envelope icon (✉) appears in the screen.

### 1 Press SETUP.

### 2 Use the cursor keys to select a menu and press ENTER.

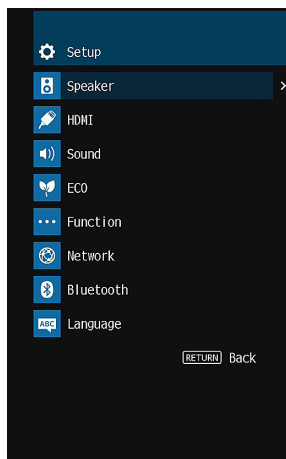

### 3 Use the cursor keys to select an item and press ENTER.

#### Note

To return to the previous screen during menu operations, press RETURN.

### 4 Use the cursor keys (</>) to select a setting and press ENTER.

### 5 To exit from the menu, press SETUP.

## Setup menu items

Menu	Item	Function	Page	
Speaker	Configuration	<b>Power Amp Assign</b>	Selects a speaker system.	p.94
		<b>Subwoofer</b>	Selects whether or not a subwoofer is connected.	p.94
		<b>Front</b>	Selects the size of the front speakers.	p.94
		<b>Center</b>	Selects whether or not a center speaker is connected and its size.	p.95
		<b>Surround</b>	Selects whether or not surround speakers are connected and their size.	p.95
		<b>Surround Back</b>	Selects whether or not surround back speakers are connected and their size.	p.95
		<b>Presence</b>	Selects whether or not presence speakers are connected and their size.	p.95
		<b>Layout</b>	Selects the layouts of the presence speakers.	p.96
		<b>Crossover</b>	Sets the lower limit of the low-frequency component that can be output from speakers whose size is set to "Small".	p.96
		<b>Subwoofer Phase</b>	Sets the phase of the subwoofer.	p.96
		<b>Extra Bass</b>	Enables/disables Extra Bass.	p.96
		<b>Virtual CINEMA FRONT</b>	Selects whether to use the front 5-channel speaker (Virtual CINEMA FRONT) configuration.	p.97
		<b>Distance</b>	Sets the distance between each speaker and listening position.	p.97
		<b>Level</b>	Adjusts the volume of each speaker.	p.97
		<b>Equalizer</b>	Adjusts the tone with an equalizer.	p.97
	<b>Test Tone</b>	Enables/disables the test tone output.	p.98	
HDMI	<b>HDMI Control</b>	Enables/disables HDMI Control.	p.99	
	<b>Audio Output</b>	Enables/disables the audio output from a TV.	p.99	
	<b>Standby Through</b>	Selects whether to output videos/audio (input through HDMI jacks) to the TV when the unit is in standby mode.	p.99	
	<b>4K Upscaling</b>	Enables/disables the upscaling function.	p.99	
	<b>TV Audio Input</b>	Selects an audio input jack of the unit to be used for TV audio input.	p.99	
	<b>Standby Sync</b>	Selects whether to use HDMI control to link the standby behavior of the TV and the unit.	p.100	
	<b>ARC</b>	Enables/disables ARC.	p.100	
	<b>SCENE</b>	Enables/disables SCENE link playback.	p.100	



Menu	Item	Function	Page	
Sound	DSP Parameter	<b>CINEMA DSP 3D Mode</b>	Enables/disables CINEMA DSP 3D.	p.101
		<b>Center Spread</b>	Selects whether to spread the center channel signals to left and right when 2-channel source is played.	p.101
		<b>Center Image</b>	Adjusts the center localization (broadening effect) of the front sound field.	p.101
	Lipsync	<b>Select</b>	Selects the method to adjust the delay between video and audio output.	p.101
		<b>Adjustment</b>	Adjusts the delay between video and audio output manually.	p.101
	Dialogue	<b>Dialogue Level</b>	Adjusts the volume of dialogue sounds.	p.102
		<b>DTS Dialogue Control</b>	Adjusts the volume of dialogue sounds for DTS contents.	p.102
		<b>Dialogue Lift</b>	Adjusts the perceived height of dialogue sounds.	p.102
	Volume	<b>Scale</b>	Switches the scale of the volume display.	p.103
		<b>Dynamic Range</b>	Selects the dynamic range adjustment method for bitstream audio (Dolby Digital and DTS signals) playback.	p.103
		<b>Max Volume</b>	Sets the limit value of the volume.	p.103
		<b>Initial Volume</b>	Sets the initial volume for when this receiver is turned on.	p.103
<b>ZoneB Volume</b>		Selects whether to adjust the volume for Zone B in conjunction with the volume for Zone A.	p.103	
ECO	<b>Auto Power Standby</b>	Set the amount of time for the auto-standby function.	p.104	
	<b>ECO Mode</b>	Enables/disables the eco mode (power saving mode).	p.104	
Function	<b>Input Rename</b>	Changes the input source name displayed on the front display.	p.105	
	<b>Input Skip</b>	Set which input source is skipped when operating the INPUT knob.	p.106	
	<b>Dimmer</b>	Adjusts the brightness of the front display.	p.106	
	<b>Memory Guard</b>	Prevents accidental changes to the settings.	p.106	
	<b>Remote Color Key</b>	Set the unit's functions for the RED/GREEN/YELLOW/BLUE key of the remote control.	p.107	
Network	<b>Information</b>	Displays the network information on the unit.	p.108	
	<b>Network Connection</b>	Selects the network connection method.	p.108	
	<b>IP Address</b>	Configures the network parameters (such as IP address).	p.108	
	<b>MAC Address Filter</b>	Sets the MAC address filter to limit access to the unit from other network devices.	p.109	
	<b>DMC Control</b>	Selects whether to allow a DLNA-compatible Digital Media Controller (DMC) to control playback.	p.109	
	<b>Network Standby</b>	Selects whether to enable/disable the function that turns on the unit from other network devices.	p.109	
	<b>Network Name</b>	Edits the network name (the unit's name on the network) displayed on other network devices.	p.110	
	<b>MusicCast Link Power Interlock</b>	Selects whether turning on the power of the master device of the MusicCast network (this unit) also turns on the power of other devices of the network.	p.110	
	<b>Network Update</b>	Updates the firmware via the network.	p.110	
	Bluetooth	<b>Bluetooth</b>	Enables/disables the Bluetooth functions.	p.110
Audio Receive		<b>Disconnect</b>	Terminates the Bluetooth connection between the Bluetooth device (such as smartphones) and the unit.	p.69
		<b>Bluetooth Standby</b>	Selects whether to enable/disable the function that turns on the unit from Bluetooth devices (Bluetooth standby).	p.110
Audio Send		<b>Transmitter</b>	Enables/disables the Bluetooth audio transmitter function.	p.111
		<b>Device Search</b>	Searches available Bluetooth devices (speakers/headphones) when the unit is used as a Bluetooth audio transmitter.	p.70
Language		Select an on-screen menu language.	p.111	

# Speaker

Configures the speaker settings manually.

## Note

Default settings are underlined.

## Configuration

Configures the output characteristics of the speakers.

## Note

When configuring the speaker size, as a general guideline, select "Large" if the woofer diameter of your speaker is 16 cm (6-1/4") or larger, or "Small" if it is smaller than 16 cm (6-1/4").

### Power Amp Assign

Selects a speaker system.

In addition to the 5.1- or 7.1-channel speaker system, various speaker configurations are possible using the presence speakers, Zone B speakers or bi-amp connections.

#### Settings

<u>Presence</u>	Select this option when you use presence speakers in the 5.1.2 system.
Sur.Back	Select this option when you use a normal speaker system (not using the presence speakers, Zone B speakers or bi-amp connections).
BI-AMP	Select this option when you connect front speakers that support bi-amp connections (p.81).
Zone B	Select this option when you use Zone B speakers (p.82) in addition to the speaker system in the main zone (Zone A).
5.1ch	Select this option when you don't use the SURROUND BACK/PRESENCE/BI-AMP/ZONE B terminals.

### Subwoofer

Selects whether or not a subwoofer is connected.

#### Settings

<u>Use</u>	Select this option when a subwoofer is connected. The subwoofer will produce LFE (low-frequency effect) channel audio and low-frequency components from other channels.
None	Select this option when no subwoofer is connected. The front speakers will produce LFE (low-frequency effect) channel audio and low-frequency components from other channels.

### Front

Selects the size of the front speakers.

#### Settings

<u>Small</u>	Select this option for small speakers. The subwoofer will produce front channel low-frequency components (configurable in "Crossover").
Large	Select this option for large speakers. The front speakers will produce all of the front channel frequency components.

## Note

"Front" is automatically set to "Large" when "Subwoofer" is set to "None".

## Center

Selects whether or not a center speaker is connected and its size.

### Settings

	Select this option for small speakers.
<u>Small</u>	The subwoofer or front speakers will produce center channel low-frequency components (configurable in "Crossover").
	Select this option for large speakers.
Large	The center speaker will produce all of the center channel frequency components.
	Select this option when no center speaker is connected.
None	The front speakers will produce center channel audio.

## Surround

Selects whether or not surround speakers are connected and their sizes.

### Settings

	Select this option for small speakers.
<u>Small</u>	The subwoofer or front speakers will produce surround channel low-frequency components (configurable in "Crossover").
	Select this option for large speakers.
Large	The surround speakers will produce all of the surround channel frequency components.
	Select this option when no surround speakers are connected.
None	The front speakers will produce surround channel audio. Virtual CINEMA DSP works when you select a sound program.

## Surround Back

Selects whether or not surround back speakers are connected and their sizes.

### Settings

	Select this option when one small speaker is connected.
Small x1	The subwoofer or front speakers will produce surround back channel low-frequency components (configurable in "Crossover").
	Select this option when two small speakers are connected.
<u>Small x2</u>	The subwoofer or front speakers will produce surround back channel low-frequency components (configurable in "Crossover").
	Select this option when one large speaker is connected.
Large x1	The surround back speaker will produce all of the surround back channel frequency components.
	Select this option when two large speakers are connected.
Large x2	The surround back speakers will produce all of the surround back channel frequency components.
	Select this option when no surround back speakers are connected.
None	The surround speakers and subwoofer (or front speakers) will produce surround back channel audio.

### Note

- "Surround Back" is automatically set to "None" when "Power Amp Assign" is set to other than "Sur.Back", or when "Surround" is set to "None".
- "Surround Back" is not available when "Virtual CINEMA FRONT" is set to "On".

## Presence

Selects whether or not presence speakers are connected and their size.

### Settings

<u>Small</u>	Select this option for small speakers.
Large	Select this option for large speakers.
None	Select this option when no presence speakers are connected.

### Note

"Presence" is automatically set to "None" when "Power Amp Assign" is set to other than "Presence".

## Layout

Selects a presence layout when presence speakers are used. This setting facilitates the optimization of the sound field effect.

### Settings

Front Height	Select this option when presence speakers are installed on the front side wall.
Overhead	Select this option when presence speakers are installed to the ceiling.
Dolby Enabled SP	Select this option when using the Dolby Enabled speakers as the presence speakers.

### Note

- This setting is not available when "Presence" is set to "None".
- To play Dolby Atmos contents using the presence speakers, see "Presence speaker layout" (p.21).

## Crossover

Sets the lower limit of the low-frequency components that can be output from a speaker whose size is set to "Small". A frequency sound lower than the specified value will be produced from the subwoofer or front speakers.

### Settings

40 Hz, 60 Hz, 80 Hz, 90 Hz, 100 Hz, 110 Hz, 120 Hz, 160 Hz, 200 Hz

### Note

If the volume and crossover frequency are adjustable on your subwoofer, set the volume to half and crossover frequency to maximum.

## Subwoofer Phase

Sets the phase of the subwoofer. When the bass sound is lacking or unclear, switch the subwoofer phase.

### Settings

<u>Normal</u>	Does not reverse the subwoofer phase.
Reverse	Reverses the subwoofer phase.

## Extra Bass

Enables/disables Extra Bass. When Extra Bass is enabled, you can enjoy enhanced bass sounds, regardless of the size of the front speakers and the presence or absence of the subwoofer.

### Settings

<u>Off</u>	Disables Extra Bass.
On	Enables Extra Bass.

### Note

You can also use BASS on the remote control to enable/disable Extra Bass (p.55).

## Virtual CINEMA FRONT

Selects whether to use the front 5-channel speaker (Virtual CINEMA FRONT) configuration.

### Settings

Off	Disables the front 5-channel speaker configuration.
On	Enables the front 5-channel speaker configuration.

### Note

- Select “On” only when utilizing the Virtual CINEMA FRONT configuration (p.19).
- This setting is not available when “Surround” is set to “None”.

## Distance

Sets the distance between each speaker and listening position so that sounds from the speakers reach the listening position at the same time. First, select the unit of distance from “Meter” or “Feet”.

### Choices

Front L, Front R, Center, Surround L, Surround R, Surround Back L, Surround Back R, Presence L, Presence R, Subwoofer

### Setting range

0.30 m to 3.00 m to 24.00 m (1.0 ft to 10.0 ft to 80.0 ft), 0.05 m (0.2 ft) increments

## Level

Adjusts the volume of each speaker.

### Choices

Front L, Front R, Center, Surround L, Surround R, Surround Back L, Surround Back R, Presence L, Presence R, Subwoofer

### Setting range

-10.0 dB to 0.0 dB to +10.0 dB (0.5 dB increments)

## Equalizer

Adjusts the tone with an equalizer.

### EQ Select

Selects the type of equalizer to be used.

### Settings

PEQ	Applies the parametric equalizer values obtained by the YPAO measurement (p.35).
GEQ	Select this option when you want to adjust the equalizer manually. For details, see “Manual equalizer adjustment”.
Off	Does not use the equalizer.

### Note

“PEQ” is available only when the YPAO has been performed (p.35).

## ■ Manual equalizer adjustment

- 1 Set “EQ Select” to “GEQ”.
- 2 Use the cursor keys ( $\Delta/\nabla$ ) to select “Channel” and the cursor keys ( $\leftarrow/\rightarrow$ ) to select the desired speaker channel.
- 3 Use the cursor keys ( $\Delta/\nabla$ ) to select the desired band (frequency) and the cursor keys ( $\leftarrow/\rightarrow$ ) to adjust the gain.

### Setting range

-6.0 dB to +6.0 dB

- 4 To exit from the menu, press SETUP.

## ■ Test Tone

Enables/disables the test tone output. Test tone output helps you to adjust the speaker balance or equalizer while confirming its effect.

### Settings

Off	Does not output test tones.
On	Outputs test tones automatically when you adjust the speaker balance or equalizer.

# HDMI

Configures the HDMI settings.

## Note

Default settings are underlined.

## HDMI Control

Enables/disables HDMI Control (p.132).

### Settings

<u>Off</u>	Disables HDMI Control.
On	Enables HDMI Control. Configure the settings in "TV Audio Input", "Standby Sync", "ARC", and "SCENE".

## Note

To use HDMI control, you need to perform the HDMI Control link setup (p.132) after connecting HDMI Control-compatible devices.

## Audio Output

Enables/disables the audio output from a TV connected to the HDMI OUT jack.

### Settings

<u>Off</u>	Disables the audio output from the TV.
On	Enables the audio output from the TV.

## Note

This setting is available only when "HDMI Control" is set to "Off".

## Standby Through

Select whether to output videos/audio (input through HDMI jacks) to the TV when the unit is in standby mode. If this function is set to "On" or "Auto", you can use the input selection keys (HDMI 1–4) to select an HDMI input even when the unit is in standby mode (the standby indicator on the unit blinks).

### Settings

<u>Off</u>	(When "HDMI Control" is set to "Off") Does not output videos/audio to the TV.
Auto	Automatically selects whether to output videos/audio depending on the status of the connected device.
On	Outputs videos/audio to the TV. (The unit consumes more power than when "Off" is selected.)

## 4K Upscaling

Enables/disables the upscaling function. When it is enabled, 1080p content is displayed at 4K resolution.

### Settings

<u>Off</u>	Disables the upscaling function.
On	Enables the upscaling function.

## TV Audio Input

Selects an audio input jack of the unit to be used for TV audio input when "HDMI Control" is set to "On". The unit's input source automatically switches to TV audio when the TV input is switched to its built-in tuner.

### Settings

AV 1–3, AUDIO 1–3

### Default

AUDIO1

## Note

When using ARC to input TV audio to the unit, you cannot use the input jacks selected here for connecting an external device because the input will be used for TV audio input.

## ■ Standby Sync

Select whether to use HDMI control to link the unit's standby mode to the TV's power when "HDMI Control" is set to "On".

### Settings

Off	Does not set the unit to standby mode when the TV is turned off.
On	Sets the unit to standby mode when the TV is turned off.
<u>Auto</u>	Sets the unit to standby mode when the TV is turned off only when the unit is receiving TV audio or HDMI signals.

## ■ ARC

Enables/disables ARC (p.26) when "HDMI Control" is set to "On".

### Settings

Off	Disables ARC.
<u>On</u>	Enables ARC.

### Note

You do not need to change this setting normally. In case noises are produced from the speakers connected to the unit because TV audio signals input to the unit via ARC are not supported by the unit, set "ARC" to "Off" and use the TV's speakers.

## ■ SCENE

Enables/disable SCENE link playback when "HDMI Control" is set to "On".

When SCENE link playback is enabled, HDMI Control-compatible devices connected to the unit via HDMI automatically works as follows, with a scene selection.

- TV: turning on and displaying video from the playback device
- Playback device: starting playback

### Choices (SCENE keys)

BD / DVD, TV, NET, RADIO

### Settings

Off	Disables SCENE link playback for the selected SCENE key.
<u>On</u>	Enables SCENE link playback for the selected SCENE key.

### Default

BD / DVD, TV: On

NET, RADIO: Off

### Note

SCENE link playback may not work properly due to the compatibility between devices. We recommend using TV and playback devices from the same manufacturer so that HDMI Control works more effectively.



# Sound

Configures the audio output settings.

### Note

Default settings are underlined.

## DSP Parameter

Configures the surround decoder settings.

### CINEMA DSP 3D Mode

Enables/disables CINEMA DSP 3D (p.52). If this function is set to "On", CINEMA DSP 3D functions with the selected sound programs (except 2ch Stereo and 7ch Stereo).

#### Settings

<u>Off</u>	Disables CINEMA DSP 3D.
<u>On</u>	Enables CINEMA DSP 3D.

### Center Spread

Selects whether to spread the center channel signals to left and right when 2-channel source is played. If you feel the center sound is too strong, set this function to "On". This setting is effective when "Dsur" is selected.

#### Settings

<u>Off</u>	Disables Center Spread.
<u>On</u>	Enables Center Spread.

### Center Image

Adjusts the center localization (broadening effect) of the front sound field. Adjust this higher to strengthen the center localization (less broadening effect) or lower to weaken it (more broadening effect). This setting is effective when "Neo:6 Music" is selected.

#### Setting range

0.0 to 0.3 to 1.0

## Lipsync

Adjusts the delay between video and audio output.

### Note

You can enable/disable the Lipsync function by input sources in "Lipsync (Lipsync)" (p.89) in the "Option" menu.

### Select

Selects the method to adjust the delay between video and audio output.

#### Setting range

<u>Manual</u>	Select this option when you want to adjust the delay between video and audio output manually. Adjust the audio output timing in "Adjustment".
<u>Auto</u>	Adjusts the delay between video and audio output automatically when a TV that supports an automatic lipsync function is connected to the unit via HDMI. If necessary, you can fine-adjust the audio output timing in "Adjustment".

### Note

"Select" is automatically set to "Manual" depending on the TV connected to the unit.

### Adjustment

Adjusts the delay between video and audio output manually when "Select" is set to "Manual". You can fine-adjust the audio output timing when "Select" is set to "Auto".

#### Setting range

0 ms to 500 ms (1 ms increments)

## Dialogue

Adjusts the volume of dialogue sounds.

### Dialogue Level

Adjusts the volume of the center orientation sounds such as dialogue.

#### Setting range

0 to 3 (higher to strengthen)

#### Note

This setting is not available when DTS:X content is played back, or when the Dolby Surround or Neural:X decoder is working.

### DTS Dialogue Control

Adjusts the volume of dialogue sounds for DTS contents.

#### Setting range

0 to 6 (higher to strengthen)

#### Note

This setting is available only when DTS:X content which supports the DTS Dialogue Control feature is played back.

## Dialogue Lift

Adjusts the perceived height of dialogue sounds. If the dialogue sounds as if it is coming from below the TV screen, you can raise its perceived height by increasing this setting.

#### Note

This setting is available only when one of the following conditions is met.

- One of the sound programs (except for 2ch Stereo and 7ch Stereo) is selected when presence speakers are used.
- Virtual Presence Speaker (VPS) (p.8) is working.  
(You may hear dialogue sounds from the surround speakers depending on the listening position.)

#### Setting range

0 to 5 (The bigger the value the higher the position)

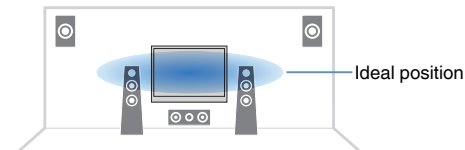

## Volume

Configures the volume settings.

### Scale

Switches the scale of the volume display.

#### Settings

<u>dB</u>	Displays the volume in the "dB" unit.
0-97	Displays the volume in the numeric value (0.5 to 97.0).

### Dynamic Range

Selects the dynamic range adjustment method for bitstream audio (Dolby Digital and DTS signals) playback.

#### Settings

<u>Maximum</u>	Produces audio without adjusting the dynamic range.
Standard	Optimizes the dynamic range for regular home use.
	Sets the dynamic range for clear sound even at night or at low volumes.
Min/Auto	When playing back Dolby TrueHD signals, the dynamic range is automatically adjusted based on the input signal information.

### Max Volume

Sets the limit value of the volume.

#### Setting range

-30.0 dB to +15.0 dB (5.0 dB increments), +16.5 dB [50.0 to 95.0 (5.0 increments), 97.0]

### Initial Volume

Sets the initial volume when the receiver is turned on.

#### Settings

<u>Off</u>	Sets the level to the volume level of the unit when it last entered standby mode.
Mute	Sets the unit to mute the audio output.
-80.0 dB to +16.5 dB (0.5 dB increments) [0.5 to 97.0 (0.5 increments)]	Sets the level to the specified volume level.

### ZoneB Volume

Selects whether to adjust the volume for Zone B in conjunction with the volume for Zone A.

#### Settings

<u>Sync.</u>	Adjusts the volume for Zone B in conjunction with the volume for Zone A.
Async.	Does not adjust the volume for Zone B in conjunction with the volume for Zone A. Adjust the volume for Zone B separately (p.84).

#### Note

If "ZoneB Volume" is set to "Async.", the volume for Zone B is temporarily set to -40 dB. As necessary, adjust the volume using the remote control (p.84).

## ECO

---

Configures the power supply settings.

### Note

Default settings are underlined.

## ■ Auto Power Standby

Set the amount of time for the auto-standby function.

### Settings

<u>Off</u>	Does not set the unit to standby mode automatically.
20 minutes	Sets the unit to standby mode when you have not operated the unit and the unit has not detected any input signal for the specified time.
2 hours, 4 hours, 8 hours, 12 hours	Sets the unit to standby mode when you have not operated the unit for the specified time.

### Default

U.K. and Europe models: 20 minutes

Other models: Off

### Note

Just before the unit enters standby mode, "AutoPowerStdby" appears and then countdown starts in the front display.

## ■ ECO Mode

You can reduce the unit's power consumption by setting the eco mode to "On". After setting, be sure to press ENTER to restart the unit.

When the eco mode is enabled, you can reduce the unit's power consumption.

### Settings

<u>Off</u>	Disables the eco mode.
On	Enables the eco mode.

### Note

- When "ECO Mode" is set to "On", the front panel display may become dark.
- If you want to play audio at high volume, set "ECO Mode" to "Off".

# Function

Configures the functions that make the unit easier to use.

## Note

Default settings are underlined>.

## Input Rename

Changes the input source name displayed on the front display. You can also select a name created by the Auto Rename function.

### Input sources

HDMI 1-4, AV 1-3, AUX, AUDIO 1-3, TUNER, MusicCast Link, SERVER, NET RADIO, Bluetooth, USB

### Default

HDMI 1-4: Auto

Others: Manual (For AUX, AUDIO 3, TUNER, MusicCast Link, SERVER, NET RADIO, Bluetooth, USB only "Manual" can be selected.)

### Procedure to rename automatically

- 1 Use the cursor keys ( $\Delta/\nabla$ ) to select an input source to be renamed.**
- 2 Use the cursor keys ( $\triangleleft/\triangleright$ ) to select "Auto".**

The unit creates a name automatically according to the connected device.
- 3 To change another input source, repeat steps 1 to 2.**
- 4 To exit from the menu, press SETUP.**

## Note

During selecting "Auto", the created name is saved even after the device connection is terminated. To reset to the default setting, switch the setting to "Manual" at once and then set it again to "Auto".

### Procedure to rename manually

- 1 Use the cursor keys ( $\Delta/\nabla$ ) to select an input source to be renamed.**
- 2 Use the cursor keys ( $\triangleleft/\triangleright$ ) to select "Manual" and press ENTER.**

The edit screen is displayed.
- 3 Use the cursor keys and ENTER key to edit the name, and then select "OK" and press ENTER.**

**Note**

  - To cancel the entry, select "CANCEL".
  - If you select "RESET", the default input name will be inserted into the editing area.
- 4 To change another input source name, repeat steps 1 to 4.**
- 5 To exit from the menu, press SETUP.**

## ■ Input Skip

Set which input source is skipped when operating the INPUT knob.  
You can select the desired input source quickly by using this function.

### Input sources

HDMI 1-4, AV 1-3, AUX, AUDIO 1-3, TUNER, NET, Bluetooth, USB

### Settings

<u>Off</u>	Does not skip the selected input source.
On	Skips the selected input source.

## ■ Dimmer

Adjusts the brightness of the front display.

### Setting range

-4 to 0 (higher to brighten)

### Note

The front display may become dark when "ECO Mode" (p.104) is set to "On".

## ■ Memory Guard

Prevents accidental changes to the settings.

### Settings

<u>Off</u>	Does not protect the settings.
On	Protects the settings until "Off" is selected.

### Note

When "Memory Guard" is set to "On", the lock icon (🔒) is displayed on the menu screen.

## ■ Remote Color Key

Set the unit's functions for the RED/GREEN/YELLOW/BLUE key of the remote control.

### Settings

Default	Assigns the functions of playback devices connected to the unit with an HDMI cable.
Input	<p>Assigns the unit's input sources to each key. The assigned input sources can be set separately.</p> <p><b>Input sources</b> HDMI 1-4, AV 1-3, AUX, AUDIO 1-3, TUNER, NET, Bluetooth, USB</p> <p><b>Default</b> RED: HDMI2, GREEN: HDMI4, YELLOW: AV 2, BLUE: AUX</p>
Program	<p>Assigns the functions of sound mode to each key.</p> <p>RED: MOVIE GREEN: MUSIC YELLOW: STEREO BLUE: SUR.DECODE</p> <p>For example, if you press the RED key repeatedly, you can select your favorite sound program from the sound programs (MOVIE) (p.52) suitable for the video source.</p>

## Network

Configures the network settings.

### Note

Default settings are underlined.

### Information

Displays the network information on the unit.

Status	The connection status of the NETWORK jack
Connection	Connection method
SSID	The access point to which the unit is connected
Security	The encryption method for your network
MusicCast Network	Readiness or not for the MusicCast Network
MAC Address (Ethernet)	MAC address
MAC Address (Wi-Fi)	
IP Address	IP address
Subnet Mask	Subnet mask
Default Gateway	The IP address of the default gateway
DNS Server (P)	The IP address of the primary DNS server
DNS Server (S)	The IP address of the secondary DNS server

### Network Connection

Selects the network connection method.

#### Choices

<u>Wired</u>	Select this option when you want to connect the unit to a network with a commercially-available network cable.
Wireless(Wi-Fi)	Select this option when you want to connect the unit to a network via the wireless router (access point). For details on settings, see "Connecting the unit to a wireless network" (p.40).
Wireless Direct	Select this option when you want to connect a mobile device to the unit directly. For details on settings, see "Connecting a mobile device to the unit directly (Wireless Direct)" (p.45).

### IP Address

Configures the network parameters (such as IP address).

#### DHCP

Select whether to use a DHCP server.

#### Settings

Off	Does not use a DHCP server. Configure the network parameters manually. For details, see "Manual network settings".
<u>On</u>	Uses a DHCP server to automatically obtain the unit's network parameters (such as IP address).

#### Manual network settings

- 1 Set "DHCP" to "Off".
- 2 Use the cursor keys ( $\Delta/\nabla$ ) to select a parameter type.

IP Address	Specifies an IP address.
Subnet Mask	Specifies a subnet mask.
Default Gateway	Specifies the IP address of the default gateway.
DNS Server (P)	Specifies the IP address of the primary DNS server.
DNS Server (S)	Specifies the IP address of the secondary DNS server.
- 3 Use the cursor keys ( $\leftarrow/\rightarrow$ ) to move the edit position and the cursor keys ( $\Delta/\nabla$ ) to select a value.
- 4 To exit from the menu, press **SETUP**.



## ■ MAC Address Filter

Sets the MAC address filter to limit access to the unit from other network devices.

### Note

Operation of the AirPlay function (p.71) or the DMC is not limited by this setting.

### Filter

Enables/disables the MAC address filter.

#### Settings

Off	Disables the MAC address filter.
On	Enables the MAC address filter. In "MAC Address 1-10", specify the MAC addresses of the network devices that will be permitted access to the unit.

### MAC Address 1-10

Specifies the MAC addresses (up to 10) of the network devices that will be permitted access to the unit when "Filter" is set to "On".

### ■ Procedure

- 1 Use the cursor keys (Δ/▽) to select an MAC address number (1 to 10).**
- 2 Use the cursor keys (◀/▶) to move the edit position and the cursor keys (Δ/▽) to select a value.**
- 3 To exit from the menu, press SETUP.**

## ■ DMC Control

Selects whether to allow DLNA-compatible Digital Media Controller (DMC) to control playback.

#### Settings

Disable	Does not allow DMCs to control playback.
Enable	Allows DMCs to control playback.

### Note

A Digital Media Controller (DMC) is a device that can control other network devices through the network. When this function is enabled, you can control playback of the unit from DMCs (such as Windows Media Player 12) on the same network.

## ■ Network Standby

Selects whether the unit can be turned on from other network devices (network standby).

#### Settings

Off	Disables the network standby function.
On	Enables the network standby function. (The unit consumes more power than when "Off" is selected.)
Auto	Enables the network standby function. (If "Network Connection" is set to "Wired", the unit is set to the power saving mode when the network cable is disconnected.)



With an advanced energy saving design, this product achieves a low power consumption of not more than two watts when in Network Standby mode.

## ■ Network Name

Edits the network name (the unit's name on the network) displayed on other network devices.

### Procedure

- 1 Press ENTER to enter the name edit screen.**
- 2 Use the cursor keys and ENTER key to edit the name, and then select "OK" to confirm the new name.**
- 3 To exit from the menu, press SETUP.**

## ■ MusicCast Link Power Interlock

Selects whether turning on the power of the master device of the MusicCast network (this unit) also turns on the power of other devices of the network.

### Settings

<u>Off</u>	Disables the power interlock from the unit (MusicCast master).
<u>On</u>	Enables the power interlock from the unit (MusicCast master).

## ■ Network Update

Updates the firmware via the network.

### Perform Update

Starts the process to update the unit's firmware.

### Firmware Version

Displays the version of the firmware installed on the unit.

### System ID

Displays the system ID number.

## Bluetooth

Configures the Bluetooth settings.

### ■ Bluetooth

Enables/disables the Bluetooth function (p.69).

#### Settings

<u>Off</u>	Disables the Bluetooth function.
<u>On</u>	Enables the Bluetooth function.

### ■ Audio Receive

Configures the Bluetooth settings when the unit is used as the Bluetooth audio receiver.

#### Bluetooth Standby

Selects whether to enable/disable the function that turns on the unit from Bluetooth devices (Bluetooth standby). If this function is set to "On", the unit automatically turns on when a connect operation is performed on the Bluetooth device.

#### Settings

<u>Off</u>	Disables the Bluetooth standby function.
<u>On</u>	Enables the Bluetooth standby function. (The unit consumes more power than when "Off" is selected.)

#### Note

This setting is not available when "Network Standby" (p.109) is set to "Off".

## Audio Send

Configures the Bluetooth settings when the unit is used as the Bluetooth audio transmitter.

### Transmitter

Enables/disables the Bluetooth audio transmitter function.

When this function is enabled, you can enjoy audio played back on the unit using Bluetooth speakers/headphones (p.70).

### Settings

<u>Off</u>	Disables the Bluetooth audio transmitter function.
On	Enables the Bluetooth audio transmitter function.

## Language

Select an on-screen menu language.

### Note

Default settings are underlined.

### Settings

<u>English</u>	English
日本語	Japanese
Français	French
Deutsch	German
Español	Spanish
Русский	Russian
Italiano	Italian
中文	Chinese

### Note

The information on the front display is provided in English only.

## Configuring the system settings (ADVANCED SETUP menu)

Configure the system settings of the unit while viewing the front display.

- 1 Set the unit to standby mode.
- 2 While holding down STRAIGHT on the front panel, press  $\text{\textcircled{P}}$  (power).

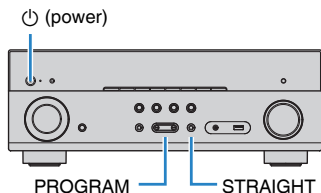

- 3 Press PROGRAM to select an item.
- 4 Press STRAIGHT to select a setting.
- 5 Press  $\text{\textcircled{P}}$  (power) to set the unit to standby mode and turn it on again.

The new settings take effect.

## ADVANCED SETUP menu items

### Note

Default settings are underlined.

Item	Function	Page
SP IMP.	(U.S.A. and Canada models only) Changes the speaker impedance setting.	p.112
REMOTE ID	Selects the unit's remote control ID.	p.113
TV FORMAT	Switches the video signal type of HDMI output.	p.113
4K MODE	Selects the HDMI 4K signal format.	p.113
DTS MODE	This setting informs the player about the DTS formats that the unit supports.	p.114
INIT	Restores the default settings.	p.114
UPDATE	Updates the firmware.	p.114
VERSION	Checks the version of firmware currently installed on the unit.	p.114

## Changing the speaker impedance setting (SP IMP.)

(U.S.A. and Canada models only)



Change the unit's speaker impedance settings depending on the impedance of the speakers connected.

### Settings

<u>6 Ω MIN</u>	Select this option when you connect 6-ohm speakers to the unit.
<u>8 Ω MIN</u>	Select this option when you connect 8-ohm or higher speakers to the unit.

## Selecting the remote control ID (REMOTE ID)

REMOTE ID • ID1

Change the unit's remote control ID so that it matches the remote control's ID (default: ID1). When using multiple Yamaha AV receivers, you can set each remote control with a unique remote control ID for its corresponding receiver.

### Settings

ID1, ID2

## Changing the remote control ID of the remote control

- To select ID1, while holding down the cursor key (◀), hold down SCENE (BD/DVD) for more than 3 seconds.  
To select ID2, while holding down the cursor key (◀), hold down SCENE (TV) for more than 3 seconds.**

## Switching the video signal type (TV FORMAT)

TV FORMAT • NTSC

Switch the video signal type of HDMI output so that it matches to the format of your TV. Since the unit automatically selects the video signal type so that it matches to the TV, it is unnecessary to change the setting normally. Change the setting only when images on the TV screen do not appear correctly.

### Settings

NTSC, PAL

### Default

U.S.A. and Canada models: NTSC

Other models: PAL

## Selecting the HDMI 4K signal format (4K MODE)

4K MODE • MODE 1

Selects the format of signals input/output at the unit when HDMI 4K compatible TV and playback device are connected to the unit.

### Settings

MODE 1	Inputs/outputs 4K signals shown in the table below. Depending on the connected device or HDMI cables, video may not be displayed correctly. In this case, select "MODE 2".
MODE 2	Inputs/outputs 4K signals shown in the table below.

### Note

When "MODE 1" is selected, use a Premium High Speed HDMI Cable or Premium High Speed Cable with Ethernet.

### Format

		MODE 1			MODE 2		
		8 bit	10 bit	12 bit	8 bit	10 bit	12 bit
4K/60, 50 Hz	RGB 4:4:4	✓	–	–	–		
	YCbCr 4:4:4	✓	–	–	–		
	YCbCr 4:2:2	–	✓	–	–		
	YCbCr 4:2:0	–	✓	–	✓	–	–
4K/30, 25, 24 Hz	RGB 4:4:4	–	✓	–	✓	–	–
	YCbCr 4:4:4	–	✓	–	✓	–	–
	YCbCr 4:2:2	–	✓	–	–	✓	–

## DTS Format Notification Setting (DTS MODE)

DTS MODE MODE1

This setting informs the player about the DTS formats that the unit supports.

### Settings

MODE 1	This mode conforms to the DTS:X standard. Use this setting under normal circumstances.
MODE 2	Use this setting if the player fails to properly output a DTS signal even when it is playing back DTS-HD or DTS:X content.

## Restoring the default settings (INIT)

INIT CANCEL

Restores the default settings for the unit.

### Choices

ALL	Restores the default settings for the unit.
CANCEL	Does not perform an initialization.

## Updating the firmware (UPDATE)

UPDATE USB

New firmware that provides additional features or product improvements will be released as needed. Updates can be downloaded from our website. If the unit is connected to the Internet, you can download the firmware via the network. For details, refer to the information supplied with updates.

### Firmware update procedure

Do not perform this procedure unless firmware update is necessary. Also, make sure you read the information supplied with updates before updating the firmware.

- 1 Press **STRAIGHT** repeatedly to select “USB” or “NETWORK” and press **INFO** to start firmware update.

### Choices

USB	Update the firmware using a USB memory device.
NETWORK	Update the firmware via the network.

## Checking the firmware version (VERSION)

VERSION XX.XX

Check the version of firmware currently installed on the unit.

### Note

- You can also check the firmware version in “Network Update” (p.110) in the “Setup” menu.
- It may take a while until the firmware version is displayed.

## Updating the unit's firmware via the network

New firmware that provides additional features or product improvements will be released as needed. If the unit is connected to the Internet, you can download the firmware via the network and update it.

### Notice

- Do not operate the unit or disconnect the power cable or network cable during firmware update. Firmware update takes about 20 minutes or more (depending on your Internet connection speed).
- If the Internet connection speed is slow, or the unit is connected to the wireless network, network update may not be possible depending on the condition of the wireless connection. In this case, update the firmware using the USB memory device (p.114).
- To perform the following procedure, your TV must be connected to the unit via HDMI. If not, perform the update from the "ADVANCED SETUP" menu (p.114).
- For details on update, visit the Yamaha website.

### Note

- You can also update the firmware using the USB memory device from the "ADVANCED SETUP" menu (p.114).
- The firmware update indicator on the front display lights up when a firmware update is available via the network.

A firmware update is available if the following message is displayed after SETUP is pressed.

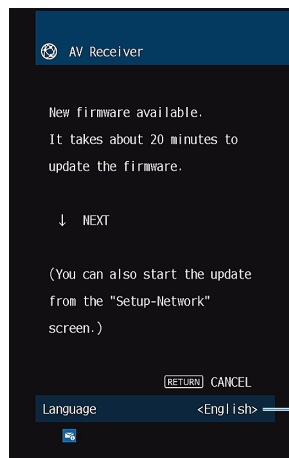

You can switch the language.

## Updating the unit's firmware immediately

- 1 Read the on-screen description and press the cursor key (▽).**
- 2 To start the firmware update, press ENTER.**  
The on-screen display turns off.
- 3 If "UPDATE SUCCESS PLEASE POWER OFF!" appears on the front display, press ⏻ (power) on the front panel.**

The firmware update is complete.

## Updating the unit's firmware at power off

- 1 Read the on-screen description and press the cursor key (▽).**  
The next screen appears on the TV.
- 2 Read the on-screen description and press the cursor key (▽).**
- 3 To set the firmware to update at power off, press ENTER.**
- 4 Press ⏻ (receiver power) to turn off the unit.**

A screen asking you to confirm the firmware update is displayed.



## **5 To start the firmware update, press ENTER.**

After the firmware update is complete, the unit will turn off automatically.

### **Note**

- The firmware update can be started by pressing INFO on the front panel.
- The unit turns off automatically without performing the firmware update if two minutes pass after the screen to confirm the firmware update is displayed.
- To cancel the firmware update process, press RETURN, and the unit will turn off.
- The unit turns off without performing the firmware update if you turn off the unit with AV CONTROLLER or MusicCast CONTROLLER.



# APPENDIX

## Frequently asked questions

The frequently asked questions from customers and the answers are shown below.

### **The new speaker system does not provide an ideal sound balance...**

If you have changed speakers or have a new speaker system, use YPAO to optimize the speaker settings again (p.35). If you want to adjust the speaker settings manually, use "Speaker" in the "Setup" menu (p.94).

### **We want to set limitations on the volume control...**

If someone accidentally operates the controls on the main unit or remote control, the volume may suddenly increase. This may also cause injury or damage the unit or speakers. We recommend using "Max Volume" in the "Setup" menu to set the maximum volume level for the unit in advance (p.103).

### **I want to fix the volume when turning on the unit...**

By default, the volume level when the unit last entered standby mode is automatically applied. If you want to fix the volume, use "Initial Volume" in the "Setup" menu to set the volume to be applied when the receiver is turned on (p.103).

### **The volume varies depending on the input sources...**

You can correct volume differences between input sources by utilizing "Input Trim" in the "Option" menu (p.89).

### **HDMI Control does not work at all...**

To use HDMI Control, you need to perform the HDMI Control link setup (p.132). After connecting HDMI Control-compatible devices (such as BD/DVD players) to the unit, enable HDMI Control on each device and perform the HDMI Control link setup. This setup is required every time you add a new HDMI Control-compatible device to your system. For information on how HDMI Control works between your TV and playback devices, refer to the instruction manuals for each device.

### **I want to change the input source name...**

By default, input source names (such as "HDMI1" and "AV 1") are displayed on the front display when an input source is selected. If you want to rename them as you like, use "Input Rename" (p.105) in the "Setup" menu.

### **I want to prevent accidental changes to the settings...**

You can protect the settings configured on the unit (such as speaker settings) by utilizing "Memory Guard" in the "Setup" menu (p.106).

### **The unit's remote control is simultaneously controlling another Yamaha product as well as the unit...**

When using multiple Yamaha products, the remote control may work on another Yamaha product or another remote control may work on the unit. If this happens, register different remote control IDs for the devices that you want to control with each remote control (p.113).

### **I want to enjoy videos/audio played back on the video device even when the unit is in standby mode...**

If you have connected a video device to the unit with HDMI, you can output videos/audio played back on the video device to the TV even when the unit is in standby mode. To use this function, set "Standby Through" (p.99) in the "Setup" menu to "On" or "Auto". You can also switch the input source using the remote control of the unit when this function is enabled.

### **The combination of video/audio input jacks does not match an external device...**

Use "Audio In" in the "Option" menu to change the combination of video/audio input jacks so that it matches the output jack(s) of your external device (p.28).

### **Video and audio are not synchronized...**

Use "Lipsync" in the "Setup" menu to adjust the delay between video and audio output (p.101).

**I want to hear audio from the TV speakers...**

Use "Audio Output" in the "Setup" menu to enable audio output from the TV speakers (p.99).

**I want to change the on-screen menu language...**

Use "Language" in the "Setup" menu to select a language from English, Japanese, French, German, Spanish, Russian, Italian and Chinese (p.33).

**I want to update the firmware...**

Use "UPDATE" in the "ADVANCED SETUP" menu to update the unit's firmware (p.114).

## Troubleshooting



Refer to the table below when the unit does not function properly.

If the problem you are experiencing is not listed below or if the instructions below do not help, turn off the unit, disconnect the power cable, and contact the nearest authorized Yamaha dealer or service center.

### First, check the following:

- 1** The power cables of the unit, TV and playback devices (such as BD/DVD players) are connected to AC wall outlets securely.
- 2** The unit, subwoofer, TV and playback devices (such as BD/DVD players) are turned on.
- 3** The connectors of each cable are securely inserted in to jacks on each device.

### Power, system and remote control

Problem	Cause	Remedy
<b>The power does not turn on.</b>	The protection circuitry has been activated three times consecutively. If the unit is in this condition, the standby indicator on the unit blinks when you try to turn on the power.	As a safety precaution, capability to turn on the power is disabled. Contact your nearest Yamaha dealer or service center to request repair.
<b>The power does not turn off.</b>	The internal microcomputer has frozen, due to an external electric shock (such as lightning or excessive static electricity) or to a drop in the power supply voltage.	Hold down  (power) on the front panel for more than 15 seconds to reboot the unit. (If the problem persists, disconnect the power cable from the AC wall outlet and plug it again.)
<b>The power turns off (standby mode) immediately.</b>	The unit was turned on while a speaker cable was shorted.	Twist the bare wires of each speaker cable firmly and reconnect to the unit and speakers (p.24).
<b>The unit enters standby mode automatically.</b>	The sleep timer worked.	Turn on the unit and start playback again.
	The auto-standby function activated because the unit was not used for the specified time.	To disable the auto-standby function, set "Auto Power Standby" in the "Setup" menu to "Off" (p.104).
	The speaker impedance setting is incorrect.	Set the speaker impedance to match your speakers (p.112).
	The protection circuitry has been activated because of a short circuit.	Twist the bare wires of each speaker cable firmly and reconnect to the unit and speakers (p.24).
<b>The unit is not reacting.</b>	The internal microcomputer is frozen, due to an external electric shock (such as lightning or excessive static electricity) or to a drop in the power supply voltage.	Hold down  (power) on the front panel for more than 15 seconds to reboot the unit. (If the problem persists, disconnect the power cable from the AC wall outlet and plug it again.)

Problem	Cause	Remedy
<b>The unit cannot be controlled using the remote control.</b>	The unit is out of the operating range.	Use the remote control within the operating range (p.6).
	The batteries are weak.	Replace with new batteries.
	The unit's remote control sensor is exposed to direct sunlight or strong lighting.	Adjust the lighting angle, or reposition the unit.
	The remote control IDs of the unit and the remote control are not identical.	Change the remote control ID of the unit or the remote control (p.113).
	The remote control is set to the Zone B operation mode.	Set the remote control to the Zone A operation mode (p.84).
<b>Cannot select the desired input source even if "INPUT" is pressed.</b>	The function which skips some input sources is set.	Set "Input Skip" of the desired input source in the "Setup" menu to "Off" (p.106).
<b>The RED/GREEN/YELLOW/BLUE keys of the remote control do not operate.</b>	The device which is connected to the unit via HDMI does not support the operation of the RED/GREEN/YELLOW/BLUE keys.	Use a device which supports the operation of the RED/GREEN/YELLOW/BLUE keys.
	The settings of the RED/GREEN/YELLOW/BLUE keys of the unit's remote control have been changed.	Set the "Remote Color Key" settings in the "Setup" menu to "Default" (p.107).

## Audio

Problem	Cause	Remedy
<b>No sound.</b>	Another input source is selected.	Select an appropriate input source with the input selection keys.
	Signals that the unit cannot reproduce are being input.	Some digital audio formats cannot be played back on the unit. To check the audio format of the input signal, use "Signal Info." in the "Option" menu (p.89).
	Audio output to Zone A (or Zone B) is disabled.	Slide the Zone switch to "ZONE A" (or "ZONE B"), and then enable audio output to Zone A (or Zone B).
	The cable connecting the unit and playback device is defective.	If there is no problem with the connection, replace with another cable.
<b>The volume cannot be increased.</b>	The maximum volume is set.	Use "Max Volume" in the "Setup" menu to adjust the maximum volume (p.103).
	A device connected to the output jacks of the unit is not turned on. (This may happen due to the nature of AV receivers.)	Turn on all devices connected to the output jacks of the unit.
<b>No sound is coming from a specific speaker.</b>	The playback source does not contain a signal for the channel.	To check it, use "Signal Info." in the "Option" menu (p.89).
	The currently selected sound program/decoder does not use the speaker.	To check it, use "Test Tone" in the "Setup" menu (p.98).
	Audio output of the speaker is disabled.	Perform YPAO (p.35) or use "Configuration" in the "Setup" menu to change the speaker settings (p.94).
	The volume of the speaker is set too low.	Perform YPAO (p.35) or use "Level" in the "Setup" menu to adjust the speaker volume (p.97).
	Audio output to Zone A (or Zone B) is disabled.	Slide the Zone switch to "ZONE A" (or "ZONE B"), and then enable audio output to Zone A (or Zone B).
	The speaker cable connecting the unit and the speaker is defective.	If there is no problem with the connection, replace with another speaker cable.
	The speaker is malfunctioning.	To check it, replace with another speaker. If the problem persists, the unit may be malfunctioning.

Problem	Cause	Remedy
<b>No sound is coming from the surround back speaker.</b>	"Power Amp Assign" is set to "Presence", "BI-AMP", "Zone B" or "5.1ch".	When "Power Amp Assign" in the "Setup" menu is set to "Presence", "BI-AMP", "Zone B" or "5.1ch", you cannot use the surround back speakers. To use the surround back speakers, set "Power Amp Assign" to "Sur.Back" (p.94).
<b>No sound is coming from the subwoofer.</b>	The playback source does not contain Low Frequency Effect (LFE) or low-frequency signals.	To check it, set "Extra Bass" in the "Setup" menu to "On", in order to output the front channel low-frequency components from the subwoofer (p.96).
	Subwoofer output is disabled.	Perform YPAO (p.35) or set "Subwoofer" in the "Setup" menu to "Use" (p.94).
	The volume of the subwoofer is too low.	Adjust the volume on the subwoofer.
<b>No sound from the playback device (connected to the unit with HDMI).</b>	The subwoofer has been turned off by its auto-standby function.	Disable the auto-standby function of the subwoofer or adjust its sensitivity level.
	The TV does not support HDCP (High-bandwidth Digital Content Protection).	Refer to the instruction manuals for the TV and check the TV's specifications.
	The number of devices connected to the HDMI OUT jack exceeds the limit.	Disconnect some of the HDMI devices.
<b>No sound from the TV (when HDMI Control is used).</b>	The TV is set to output audio from the TV speakers.	Change the audio output setting on your TV so that the TV audio is output from the speakers connected to the unit.
	A TV that does not support ARC is connected to the unit only with an HDMI cable.	Use a digital optical cable to make an audio connection (p.26).
	(If the TV is connected to the unit with an audio cable) The TV audio input setting does not match the actual connection.	Use "TV Audio Input" in the "Setup" menu to select the correct audio input jack (p.99).
	(If you are trying to use ARC) ARC is disabled on the unit or TV.	Set "ARC" in the "Setup" menu to "On" (p.100). Also, enable ARC on the TV.
<b>When playing back DSD audio, the unit disables the audio output from a TV.</b>	The unit does not support DSD audio output from a TV.	Change the audio output setting on the playback device to PCM.
<b>Only the front speakers work on multichannel audio.</b>	The playback device is set to output 2-channel audio (such as PCM) only.	To check it, use "Signal Info." in the "Option" menu (p.89). If necessary, change the digital audio output setting on the playback device.
<b>Noise/hum is heard.</b>	The unit is too close to another digital or radio frequency device.	Move the unit further away from the device.
	The cable connecting the unit and playback device is defective.	If there is no problem with the connection, replace with another cable.
<b>The sound is distorted.</b>	The volume of the unit is too high.	Turn down the volume. If "ECO Mode" in the "Setup" menu is set to "On", set it to "Off" (p.104).
	A device connected to the unit's output jacks is not turned on.	Turn on all devices connected to the unit's output jacks.

## Video

Problem	Cause	Remedy
<b>No video.</b>	Another input source is selected on the unit.	Select an appropriate input source with the input selection keys.
	Another input source is selected on the TV.	Switch the TV input to display the video from the unit.
	The video signal output from the unit is not supported by the TV.	Check the video output setting of the playback device. For information about video signals supported by the TV, refer to the instruction manuals for the TV.
	The cable connecting the unit and TV (or playback device) is defective.	If there is no problem with the connection, replace with another cable.
<b>No video from the playback device (connected to the unit with HDMI).</b>	The input video signal (resolution) is not supported by the unit.	To check the information about the current video signal (resolution), use "Signal Info." in the "Option" menu (p.89). For information about video signals supported by the unit, see "HDMI signal compatibility" (p.134).
	The TV does not support HDCP (High-bandwidth Digital Content Protection).	Refer to the instruction manuals for the TV and check the TV's specifications.
	The number of devices connected to the HDMI OUT jack is over the limit.	Disconnect some of the HDMI devices.
<b>No image (contents required the HDCP 2.2 - compatible HDMI device) from the playback device connected to the unit with HDMI.</b>	The TV (HDMI input jack) does not support HDCP 2.2. (The Warning message can be displayed on the TV screen.)	Connect the unit to the TV (HDMI input jack) that supports HDCP 2.2.
<b>The menu of the unit is not displayed on the TV.</b>	The TV is not connected to the unit via HDMI.	You can display the menu of the unit on the TV only when they are connected with an HDMI cable. If necessary, use an HDMI cable to connect them (p.26 to p.27).
	Another input source is selected on the TV.	Switch the TV input to display the video from the unit (HDMI OUT jack).

## FM/AM radio (AM radio feature is available except for U.K., Europe, Australia and Russia models)

Problem	Cause	Remedy
<b>FM radio reception is weak or noisy.</b>	There is multi-path interference.	Adjust the FM antenna height or orientation, or place it in a different location.
	Your area is too far from the FM station transmitter.	To select monaural FM radio reception "FM Mode" in the "Option" menu to "Mono" (p.56). Use an outdoor FM antenna.
<b>AM radio reception is weak or noisy.</b>	The noises may be caused by fluorescent lamps, motors, thermostats, or other electrical equipment.	It is difficult to completely eliminate noise. It may be reduced by using an outdoor AM antenna.
<b>Radio stations cannot be selected automatically.</b>	Your area is too far from the FM station transmitter.	Select the station manually (p.56). Use an outdoor antenna. We recommend using a sensitive multi-element antenna.
	The AM radio signal is weak.	Adjust the AM antenna orientation. Select the station manually (p.56). Use an outdoor AM antenna.
<b>AM radio stations cannot be registered as presets.</b>	Auto Preset has been used.	Auto Preset is for registering FM radio stations only. Register AM radio stations manually (p.58).

## DAB radio (U.K., Europe, Australia and Russia models)

Problem	Cause	Remedy
<b>No DAB radio reception.</b>	An initial scan has not been performed.	Perform an initial scan to receive DAB radio (p.60).
<b>No DAB radio reception even after performing an initial scan.</b>	Reception strength of DAB radio is poor.	Check reception strength in "Tune AID" in the "Option" menu (p.64), and adjust the antenna height or orientation, or place it in a different location.
	There is no DAB coverage in your area.	Check with your dealer or WorldDMB online at " <a href="http://www.worlddab.org">http://www.worlddab.org</a> " for a listing of the DAB coverage in your area.
<b>DAB radio reception is weak or noisy.</b>	There is multi-path interference.	Check reception strength in "Tune AID" in the "Option" menu (p.64), and adjust the antenna height or orientation, or place it in a different location.
	Your area is too far from the DAB station transmitter.	Use an outdoor antenna. We recommend using a sensitive multi-element antenna.
<b>DAB information is not available or is inaccurate.</b>	The selected DAB radio station may be temporarily out of service or may not provide information.	Contact the DAB broadcaster.
<b>No DAB radio sound.</b>	The selected DAB radio station may be temporarily out of service.	Try the station later or select another station.

## USB and network

Problem	Cause	Remedy
<b>The unit does not detect the USB device.</b>	The USB device is not connected to the USB jack securely.	Turn off the unit, reconnect your USB device, and turn the unit on again.
	The file system of the USB device is not FAT16 or FAT32.	Use a USB device with FAT16 or FAT32 format.
<b>Folders and files in the USB device cannot be viewed.</b>	The data in the USB device is protected by the encryption.	Use a USB device without an encryption function.
<b>The network feature does not function.</b>	The network parameters (IP address) have not been obtained properly.	Enable the DHCP server function on your router and set "DHCP" in the "Setup" menu to "On" on the unit (p.108). If you want to configure the network parameters manually, check that you are using an IP address which is not used by other network devices in your network (p.108).
<b>The unit does not detect the PC.</b>	The media sharing setting is not correct.	Configure the sharing setting and select the unit as a device to which music contents are shared (p.76).
	Some security software installed on your PC is blocking the access of the unit to your PC.	Check the settings of security software installed on your PC.
	The unit and PC are not in the same network.	Check the network connections and your router settings, and then connect the unit and the PC to the same network.
	The MAC address filter is enabled on the unit.	In "MAC Address Filter" in the "Setup" menu, disable the MAC address filter or specify the MAC address of your PC to allow it to access to the unit (p.109).
<b>The files in the PC cannot be viewed or played back.</b>	The files are not supported by the unit or the media server.	Use the file format supported by both the unit and the media server. For information about the file formats supported by the unit, see "Playing back music stored on media servers (PCs/NAS)" (p.76).
<b>The Internet radio cannot be played.</b>	The selected Internet radio station is currently not available.	There may be a network problem at the radio station, or the service may have been stopped. Try the station later or select another station.
	The selected Internet radio station is currently broadcasting silence.	Some Internet radio stations broadcast silence at certain of times of the day. Try the station later or select another station.
	Access to the network is restricted by the firewall settings of your network devices (such as the router).	Check the firewall settings of your network devices. The Internet radio can be played only when it passes through the port designated by each radio station. The port number varies depending on the radio station.
<b>The application for smartphone/tablet "AV CONTROLLER" does not detect the unit.</b>	The MAC address filter is enabled on the unit.	In "MAC Address Filter" in the "Setup" menu, disable the MAC address filter or specify the MAC address of your smartphone/tablet to allow it to access to the unit (p.109).
	The unit and smartphone/tablet are not in the same network.	Check the network connections and your router settings, and then connect the unit and smartphone/tablet to the same network.
<b>Firmware update via the network is failed.</b>	It may not be possible depending on the condition of the network.	Update the firmware via the network again or use a USB memory device (p.114).
<b>The mobile device does not recognize the unit when using AirPlay or AV CONTROLLER.</b>	The unit and the mobile device are connected to different SSID when using a multiple SSID router.	Connect them to the Primary SSID (at the top of the list).



Problem	Cause	Remedy
<b>The unit cannot connect to the Internet via a wireless router (access point).</b>	The wireless router (access point) is turned off.	Turn on the wireless router.
	The unit and the wireless router (access point) are too far apart.	Place the unit and the wireless router (access point) closer to each other.
	There is an obstacle between the unit and the wireless router (access point).	Move the unit and the wireless router (access point) in a location where there are no obstacles between them.
<b>Wireless network is not found.</b>	Microwave ovens or other wireless devices in your neighborhood might disturb the wireless communication.	Turn off these devices.
	Access to the network is restricted by the firewall settings of the wireless router (access point).	Check the firewall setting of the wireless router (access point).

## Bluetooth®

Problem	Cause	Remedy
<b>A Bluetooth connection cannot be established.</b>	The Bluetooth function of the unit is disabled.	Enable the Bluetooth function (p.110).
	Another Bluetooth device is already connected to the unit.	Terminate the current Bluetooth connection and then establish a new connection (p.69).
	The unit and the Bluetooth device are too far apart.	Move the Bluetooth device closer to the unit.
	There is a device (such as microwave oven and wireless LAN) that outputs signals in the 2.4 GHz frequency band nearby.	Move the unit away from those devices.
	The Bluetooth device does not support A2DP.	Use a Bluetooth device that supports A2DP.
	The connection information registered on the Bluetooth device is not working for some reason.	Delete the connection information on the Bluetooth device, and then establish a connection between the Bluetooth device and the unit again (p.69).
<b>No sound is produced, or the sound is interrupted during playback.</b>	The volume of the Bluetooth device is set too low.	Turn up the volume of the Bluetooth device.
	The Bluetooth device is not set to send audio signals to the unit.	Switch the audio output of the Bluetooth device to the unit.
	The Bluetooth connection has been terminated.	Establish a Bluetooth connection between the Bluetooth device and the unit again (p.69).
	The unit and the Bluetooth device are too far apart.	Move the Bluetooth device closer to the unit.
	There is a device (such as microwave oven and wireless LAN) that outputs signals in the 2.4 GHz frequency band nearby.	Move the unit away from those devices.

## Error indications on the front display

Refer to the table below when the error message is indicated on the front display.

Message	Cause	Remedy
<b>Access denied</b>	Access to the PC is denied.	Configure the sharing settings and select the unit as a device to which music contents are shared (p.76).
<b>Access error</b>	The unit cannot access the USB device.	Turn off the unit and reconnect your USB device. If the problem persists, try another USB device.
	There is a problem with the signal path from the network to the unit.	Make sure your router and modem are turned on. Check the connection between the unit and your router (or hub) (p.31).
<b>Check SP Wires</b>	The speaker cables short circuit.	Twist the bare wires of the cables firmly and connect to the unit and speakers properly.
<b>Internal Error</b>	An internal error has occurred.	Contact the nearest authorized Yamaha dealer or service center.
<b>No content</b>	There are no playable files in the selected folder.	Select a folder that contains files supported by the unit.
<b>No device</b>	The unit cannot detect the USB device.	Turn off the unit and reconnect your USB device. If the problem persists, try another USB device.
<b>Not connected</b>	The network cable is not connected.	Connect the network cable properly.
	The wireless router (access point) is not found.	Make sure the wireless router (access point) is turned on.
<b>Please wait</b>	The unit is preparing for connecting to the network.	Wait until the message disappears. If the message stays more than 3 minutes, turn off the unit and turn it on again.
<b>RemID Mismatch</b>	The remote control IDs of the unit and the remote control are not identical.	Change the remote control ID of the unit or the remote control (p.113).
<b>Unable to play</b>	The unit cannot play back the songs stored on the iPhone for some reason.	Check the song data. If it cannot be played on the iPhone itself, the song data or storage area may be defective.
	The unit cannot play back the songs stored on the PC for some reason.	Ensure that the files are types that the unit is able to play back. For information about the formats supported by the unit, see "Playing back music stored on media servers (PCs/NAS)" (p.76). If the unit supports the file format, but still cannot play back any files, the network may be overloaded with heavy traffic.
<b>USB Overloaded</b>	An overcurrent is flowing through the USB device.	Turn off the unit and reconnect your USB device. If the problem persists, try another USB device.
<b>Version error</b>	Firmware update is failed.	Update the firmware again.
<b>Update failed.</b>	Firmware update is failed.	Press STRAIGHT and select a firmware updating method, then press INFO to update the firmware again.

This is a glossary of the technical terms used in this manual.

## Audio information

### Audio decoding format

#### Dolby Atmos

Introduced first in the cinema, Dolby Atmos brings a revolutionary sense of dimension and immersion to the Home Theater experience. Dolby Atmos is an adaptable and scalable object based format that reproduces audio as independent sounds (or objects) that can be accurately positioned and move dynamically throughout the 3 dimensional listening space during playback. A key ingredient of Dolby Atmos is the introduction of a height plane of sound above the listener.

#### Dolby Atmos Stream

Dolby Atmos content will be delivered to your Dolby Atmos enabled AV receiver via Dolby Digital Plus or Dolby TrueHD on Blu-ray Disc, downloadable files and streaming media. A Dolby Atmos stream contains special metadata that describes the positioning of sounds within the room. This object audio data is decoded by a Dolby Atmos AV receiver and scaled for optimum playback through Home Theater speaker systems of every size and configuration.

#### Dolby Digital

Dolby Digital is a compressed digital audio format developed by Dolby Laboratories, Inc. that supports 5.1-channel audio. This technology is used for audio on most DVD disc.

#### Dolby Digital Plus

Dolby Digital Plus is a compressed digital audio format developed by Dolby Laboratories, Inc. that supports 7.1-channel audio. Dolby Digital Plus remains fully compatible with the existing multichannel audio systems that support Dolby Digital. This technology is used for audio on BD (Blu-ray Disc).

#### Dolby Surround

Dolby surround is a next generation surround technology that intelligently up mixes stereo; 5.1 and 7.1 content for playback through your surround speaker system. Dolby surround is compatible with traditional speaker layouts, as well as Dolby Atmos enabled playback systems that employ in-ceiling speakers or products with Dolby speaker technology.

#### Dolby TrueHD

Dolby TrueHD is an advanced lossless audio format developed by Dolby Laboratories, Inc. to offer a high-definition home theater experience with the quality of the studio master. Dolby TrueHD can carry up to eight channels of 96 kHz/24-bit audio (up to six channels of 192 kHz/24-bit audio) simultaneously. This technology is used for audio on BD (Blu-ray Disc).

#### DTS 96/24

DTS 96/24 is a compressed digital audio format that supports 5.1-channel and 96 kHz/24-bit audio. This format remains fully compatible with the existing multichannel audio systems that support DTS Digital Surround. This technology is used for music DVDs, etc.

#### DTS Dialog Control

DTS Dialog Control allows you to boost the dialog. This can be useful in noisy environments to help make the dialog more intelligible. People with impaired hearing may also benefit. Note that the content creator may disable the use of this feature in the mix, so that DTS Dialog Control may not always be available. Note that updates to your AVR may add more functionality to DTS Dialog Control or increase the range of the feature.

#### DTS Digital Surround

DTS Digital Surround is a compressed digital audio format developed by DTS, Inc. that supports 5.1-channel audio. This technology is used for audio on most DVD discs.

#### DTS-ES

DTS-ES creates total 6.1-channel audio from 5.1-channel sources that are recorded with DTS-ES. This decoder adds a surround back sound to the original 5.1-channel sound. In the DTS-ES Matrix 6.1 format, a surround back sound is recorded in the surround channels, and in the DTS-ES Discrete 6.1 format, a discrete surround back channel is recorded.

#### DTS Express

DTS Express is a compressed digital audio format that supports 5.1-channel audio and allows a higher compression rate than the DTS Digital Surround format developed by DTS, Inc. This technology is developed for audio streaming services on the Internet and secondary audio on BD (Blu-ray Disc).

#### DTS-HD High Resolution Audio

DTS-HD High Resolution Audio is a compressed digital audio format developed by DTS, Inc. that supports 7.1-channel and 96 kHz/24-bit audio. DTS-HD High Resolution Audio remains fully compatible with the existing multichannel audio systems that support DTS Digital Surround. This technology is used for audio on most BD (Blu-ray Disc).

#### DTS-HD Master Audio

DTS-HD Master Audio is an advanced lossless audio format developed to offer a high-definition home theater experience with the quality of the studio master by DTS, Inc. DTS-HD Master Audio can carry up to eight channels of 96 kHz/24-bit audio (up to six channels of 192 kHz/24-bit audio) simultaneously. This technology is used for audio on BD (Blu-ray Disc).

#### DTS Neo: 6

DTS Neo: 6 enables 6-channel playback from 2-channel sources. There are two modes available: "Music mode" for music sources and "Cinema mode" for movie sources. This technology provides discrete full-bandwidth matrix channels of surround sound.

#### DTS:X

DTS:X is the next generation object-based, multi-dimensional audio technology from DTS. Unbound from channels, DTS:X conveys the fluid movement of sound to create an incredibly rich, realistic and immersive soundscape - in front of, behind, beside and above the audience - more accurately than ever before. DTS:X offers the ability to automatically adapt the audio to the speaker layout that best fits the space, from a television's built-in speakers to a home surround theater system to a dozen or more speakers in a commercial cinema. Immerse yourself at [www.dts.com/dtsx](http://www.dts.com/dtsx)

## DSD (Direct Stream Digital)

DSD (Direct Stream Digital) technology stores audio signals on digital storage media, such as SACD (Super Audio CDs). The signals are stored at a high-frequency sampling rate (such as 2.8224 MHz and 5.6448 MHz). The highest frequency response is equal to or higher than 100 kHz, with a dynamic range of 120 dB. This technology offers better audio quality than that used for CDs.

## FLAC

FLAC is a file format for lossless audio data compression. FLAC is inferior to lossy compressed audio formats in compression rate but provides higher audio quality.

## MP3

One of the compressed digital audio format used by MPEG. With psychoacoustic technologies, this compression method achieves a high compression rate. Reportedly, it is capable of compressing data quantity by about 1/10 maintaining a certain level of audio quality.

## MPEG-4 AAC

An MPEG-4 audio standard. It is used for mobile telephones, portable audio players, and audio streaming services on Internet because it allows a high compression rate of data while maintaining better audio quality than MP3.

## Neural:X

Neural:X is the latest downmixing/upmixing and spatial remapping technology from DTS. It is built in to DTS:X to provide upmix of Neural:X-encoded and non-encoded (PCM) data. In DTS:X for AVRs and Sound Bars, Neural:X can produce up to 11.x channels.

## PCM (Pulse Code Modulation)

PCM is a signal format under which an analog audio signal is digitized, recorded, and transmitted. This technology is the basis of all other audio format. This technology is used as a lossless audio format called Linear PCM for audio on a variety of media, including CDs and BD (Blu-ray Disc).

## Sampling frequency/Quantization bit

Sampling frequency and quantization bits indicate the quantity of information when an analog audio signal is digitized. These values are noted as in the following example: "48 kHz/24-bit".

- Sampling frequency  
Sampling frequency (the number of times the signal is sampled per second) is called the sampling rate. When the sampling frequency is higher, the range of frequencies that can be played back are wider.
- Quantization bit  
The number of quantization bits indicate the degree of accuracy when converting the sound level into a numeric value. When the number of quantized bits is higher, the expression of the sound level is more accurate.

## WAV

Windows standard audio file format, which defines the method of recording the digital data obtained by converting audio signals. By default, the PCM method (no compression) is used, but you can also use other compression methods.

## WMA (Windows Media Audio)

One of the compressed digital audio formats developed by Microsoft Corporation. With psychoacoustic technologies, this compression method achieves a high compression rate. Reportedly, it is capable of compressing data quantity by about 1/20 maintaining a certain level of audio quality.

## Others

### Bi-amplification connection (Bi-amp)

A bi-amplification connection uses two amplifiers for a speaker. When you use the bi-amplification connection, the unit drives the tweeter and woofer in a speaker with the discrete amplifiers. As a consequence, the tweeter and woofer provide clear audio signal without the interference.

### LFE (Low Frequency Effects) 0.1 channel

This channel reproduces low-frequency bass signals and has a frequency range from 20 Hz to 120 Hz. This channel is added to the channels for all bands with Dolby Digital or DTS to enhance low frequency audio effects. This channel is labeled 0.1 because it is limited to only low frequency audio.

### Lip sync

Video output sometimes lags behind audio output due to the complexity of signal processing caused by an increase in video signal capacity. Lip sync is a technique for automatically correcting the timing lag between audio and video output.

## HDMI and video information

---

### Composite video signal

With the composite video signal system, color, brightness, and synchronization data signals are combined and transmitted with a single cable.

### Deep Color

Deep Color is a technology that HDMI specification supports. Deep Color increases the number of available colors within the boundaries defined by the RGB or YCbCr color space. Conventional color systems process the color using 8 bits. Deep Color processes the color with 10, 12, or 16 bits. This technology allows HDTVs and other displays to increase from millions of colors to billions of colors and eliminate on-screen color banding for smooth tonal transitions and subtle gradations between colors.

### HDMI

HDMI (High-Definition Multimedia Interface) is the world-wide standard interface for digital audio/video signal transmission. This interface transmits both digital audio and digital video signals using a single cable without any loss. HDMI complies with HDCP (High-bandwidth Digital Content Protection) and provides a secure audio/video interface. For further information on HDMI, visit the HDMI website at "<http://www.hdmi.org/>".

### x.v.Color

"x.v.Color" is a technology that the HDMI specification supports. It is a more extensive color space than sRGB and allows the expression of colors that were not hitherto possible. While remaining compatible with the color gamut of sRGB standards, "x.v.Color" expands the color space, and thus can produce more vivid, natural images.

## Network information

---

### SSID

SSID (Service Set Identifier) is a name that identifies a particular wireless LAN access point.

### Wi-Fi

Wi-Fi (Wireless Fidelity) is a technology that allows an electronic device to exchange data or connect to the Internet wirelessly using radio waves. Wi-Fi offers the advantage of eliminating the complexity of making connections with LAN cables by using wireless connection. Only products that complete Wi-Fi Alliance interoperability tests can carry the "Wi-Fi Certified" trademark.

### WPS

WPS (Wi-Fi Protected Setup) is a standard established by the Wi-Fi Alliance, which allows easy establishment of a wireless home network.

## Yamaha technologies

---

### CINEMA DSP (Digital Sound Field Processor)

Since the surround sound systems were originally designed for use in movie theaters, their effect is best experienced in a theater that has many speakers designed for acoustic effects. Since home conditions (such as room size, wall material, and number of speakers) can differ so widely, it is inevitable that there are differences in the sound that you hear. Based on a wealth of actually measured data, CINEMA DSP, Yamaha's original DSP technology provides the audiovisual experience of a movie theater in your own home.

### CINEMA DSP 3D

The actually measured sound field data contain the information of the height of the sound images. CINEMA DSP 3D mode achieves the reproduction of the accurate height of the sound images so that it creates the accurate and intensive 3D sound fields in a listening room.

### Compressed Music Enhancer

The Compressed Music Enhancer feature compensates for missing harmonics in compression music formats (such as MP3). As a result, this technology provides improved performance for the overall sound system.

### SILENT CINEMA

Yamaha has developed a natural, realistic sound effect DSP algorithm for headphones. Parameters for headphones have been set for each sound program, so that accurate representations of all the sound programs can be enjoyed on headphones.

### Virtual CINEMA DSP

Virtual CINEMA DSP allows the system to virtually reproduce the sound field of the surround speakers with front left and right speakers. Even if the surround speakers are not connected, the unit creates the realistic sound field in a listening room.

### Virtual Presence Speaker (VPS)

Virtual Presence Speaker allows the system to virtually reproduce the height of the 3D sound field without front presence speakers. Even if the front presence speakers are not connected, the unit creates the 3D sound field in your room.

### YPAO (Yamaha Parametric room Acoustic Optimizer)

The Yamaha Parametric room Acoustic Optimizer (YPAO) function detects speaker connections, measures the distances from them to your listening position(s), and then automatically optimizes the speaker settings, such as volume balance and acoustic parameters, to suit your room.

### Virtual Surround Back Speaker (VSBS)

Virtual Surround Back Speaker allows the system to virtually reproduce the sound field of the surround back speakers with surround speaker. Even if the surround back speakers are not connected, the unit adds a sense of depth to the rear sound field of CINEMA DSP.

## Supported devices and file formats

The following devices and file formats can be used by the unit.

### Supported devices

#### Bluetooth® devices

- Bluetooth devices that support A2DP can be used.
- Operation of all Bluetooth devices cannot be guaranteed.

#### USB devices

- This unit supports USB mass storage class devices (e.g., flash memories or portable audio players) using FAT16 or FAT32 format.
- Do not connect devices other than USB mass storage class devices (such as USB chargers or USB hubs), PCs, card readers, an external HDD, etc.
- USB devices with encryption cannot be used.
- Operation of all USB devices cannot be guaranteed.

#### AirPlay

AirPlay works with iPhone, iPad, and iPod touch with iOS 4.3.3 or later, Mac with OS X Mountain Lion or later, and PC with iTunes 10.2.2 or later.

##### Made for.

iPhone 7 Plus, iPhone 7, iPhone SE, iPhone 6s Plus, iPhone 6s, iPhone 6 Plus, iPhone 6, iPhone 5s, iPhone 5c, iPhone 5, iPhone 4s

iPad Pro (9.7" and 12.9"), iPad mini 4, iPad Air 2, iPad mini 3, iPad Air, iPad mini 2, iPad mini, iPad (3rd and 4th generation), iPad 2

iPod touch (5th and 6th generation)

(as of February 2017)

## File formats

### USB, PC/NAS

File	Sampling frequency (kHz)	quantization bit (bit)	Bitrate (kbps)	Number of channels	Support for gapless playback
WAV *	32/44.1/48/ 88.2/96/ 176.4/192	16/24	-	2	✓
MP3	32/44.1/48	-	8 to 320	2	-
WMA	32/44.1/48	-	8 to 320	2	-
MPEG-4 AAC	32/44.1/48	-	8 to 320	2	-
FLAC	32/44.1/48/ 88.2/96/ 176.4/192	16/24	-	2	✓
ALAC	32/44.1/48/ 88.2/96	16/24	-	2	✓
AIFF	32/44.1/48/ 88.2/96/ 176.4/192	16/24	-	2	✓
DSD	2.8 MHz/ 5.6 MHz	1	-	2	-

\* Linear PCM format only

- To play back FLAC files stored on your PC/NAS, you need to install server software that supports sharing of FLAC files via DLNA on your PC or use a NAS that supports FLAC files.
- Digital Rights Management (DRM) contents cannot be played back.

# Video signal flow

Video signals input from a video device to the unit are output to a TV as shown below.

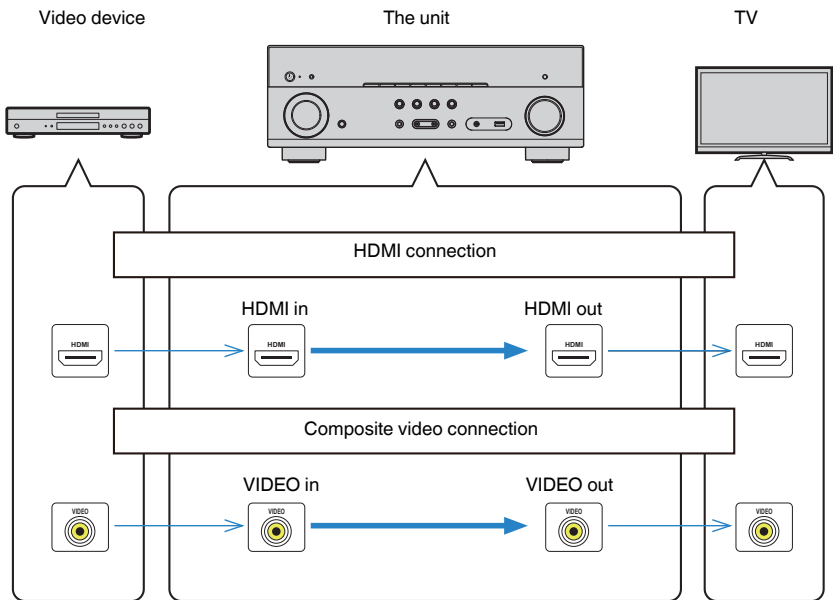

## Information on HDMI

The additional information on HDMI is as follows.

### HDMI Control

HDMI Control allows you to operate external devices via HDMI. If you connect a TV that supports HDMI Control to the unit with an HDMI cable, you can control the unit (such as power and volume) with TV remote control operations. You can also control playback devices (such as HDMI Control-compatible BD/DVD players) connected to the unit with an HDMI cable.

#### Operations available from the TV's remote control

- Standby synchronization
- Volume control including mute
- Switching to input audio from the TV when the TV input is switched to its built-in tuner
- Switching to input video/audio from the selected playback device
- Switching between audio output devices (the unit or TV speaker)

#### (Example)

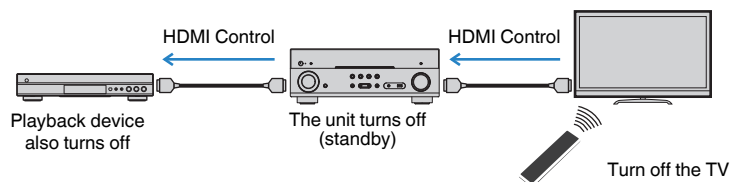

#### Operations available from the unit's remote control

- Starting playback on the playback device and turning on the TV with a scene selection (p.50)
- Switching the TV input to display the "Setup" menu (when SETUP is pressed)
- Controlling the playback device (playback and menu operations)

#### (Example)

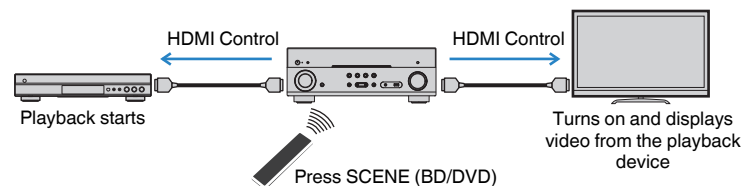

To use HDMI Control, you need to perform the following HDMI Control link setup after connecting the TV and playback devices.

For details on settings and operating your TV, refer to the instruction manual for the TV.

#### Note

This setup is required every time you add a new HDMI Control-compatible device to your system.

#### 1 Turn on the unit, TV, and playback devices.

#### 2 Configure the settings of the unit.

##### 1 Switch the TV input to display video from the unit.

##### 2 Press SETUP.

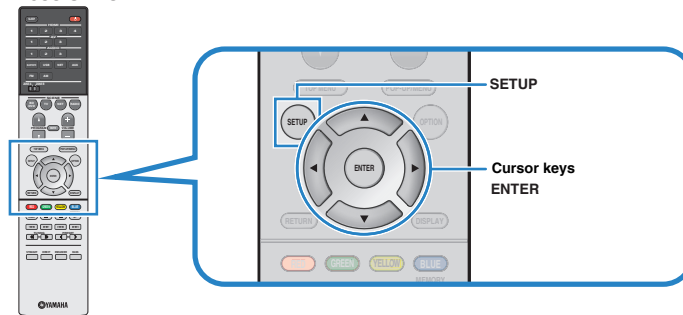



- 3** Use the cursor keys to select “HDMI” and press ENTER.

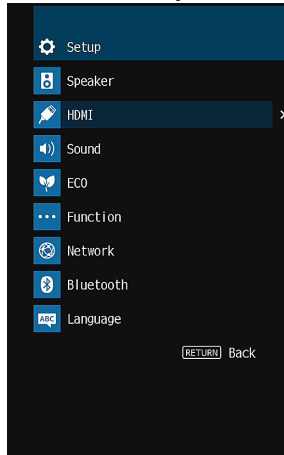

- 4** Use the cursor keys ( $\Delta/\nabla$ ) to select “HDMI Control” and the cursor keys ( $\langle/\rangle$ ) to select “On” as shown below.

- 5** If you made a digital optical cable connection between the TV and the unit, use the cursor keys ( $\Delta/\nabla$ ) to select “TV Audio Input” and the cursor keys ( $\langle/\rangle$ ) to select “AUDIO1”.

- 6** Press SETUP.

- 3** Enable HDMI Control on the TV and playback devices (such as HDMI Control-compatible BD/DVD players).
- 4** Turn off the main power of the TV and then turn off the unit and playback devices.
- 5** Turn on the unit and playback devices and then turn on the TV.
- 6** Switch the TV input to display the video from the unit.
- 7** Check the followings.

**On the unit:** The input to which the playback device is connected is selected. If not, select the input source manually.

**On the TV:** The video from the playback device is displayed.

- 8** Check that the unit is properly synchronized with the TV by turning off the TV or adjusting the TV volume with the TV remote control.

**Note**

- If HDMI Control does not work properly, the problem may be solved by turning the playback device off and on again, or by unplugging the power plug and plugging it in again. Also, HDMI Control may not work properly if the number of connected devices exceeds the limit. In this case, disable HDMI Control on devices not in use.
- If the unit is not synchronized to the TV's power operations, check the priority of the audio output setting on the TV.
- If you reconnect the HDMI cable, perform the procedure 5-8 again.
- We recommend using TV and playback devices from the same manufacturer so that HDMI Control works more effectively.

## Audio Return Channel (ARC)

---

ARC allows you to input TV audio to the unit with the HDMI cable which transmits video signal to the TV.

Check the following after the HDMI Control settings.

- 1 Select a TV program with the TV remote control.**
- 2 Check that the input source of the unit will be automatically switched to “AUDIO1” and the TV audio will be played back on the unit.**

If you cannot hear the TV audio, check the following:

- “ARC” (p.100) in the “Setup” menu is set to “On”.
- The HDMI cable is connected to the ARC-compatible HDMI jack (HDMI jack marked “ARC”) on the TV.

Some HDMI jack on the TV is not compatible with ARC. For details, refer to the instruction manual for the TV.

### Note

- If the audio is interrupted while using ARC, set “ARC” (p.100) in the “Setup” menu to “Off” and use a digital optical cable to input TV audio to the unit (p.26).
- When using ARC, connect a TV with an HDMI cable that supports ARC.
- “AUDIO1” is set as TV audio input at the factory. If you have connected any external device to the AUDIO 1 jacks, use “TV Audio Input” (p.99) in the “Setup” menu to change the TV audio input assignment. To use the SCENE function (p.50), you also need to change the input assignment for SCENE (TV).

## HDMI signal compatibility

---

- When CPPM copy-protected DVD-Audio is played back, video/audio signals may not be output, depending on the type of the DVD player.
- The unit is not compatible with HDCP-incompatible HDMI or DVI devices. For details, refer to the instruction manual for each device.
- To decode audio bitstream signals on the unit, set the input source device appropriately so that the device outputs the bitstream audio signals directly (does not decode the bitstream signals on the playback device). For details, refer to the instruction manual for the playback device.

## Trademarks

The trademarks used in this manual are as follows.

### DOLBY ATMOS™

Manufactured under license from Dolby Laboratories. Dolby, Dolby Atmos, Dolby Surround, and the double-D symbol are trademarks of Dolby Laboratories.



For DTS patents, see <http://patents.dts.com>. Manufactured under license from DTS, Inc. DTS, the Symbol, DTS in combination with the Symbol, DTS:X, and the DTS:X logo are registered trademarks or trademarks of DTS, Inc. in the United States and/or other countries. © DTS, Inc. All Rights Reserved.

Made for



Supports iOS 7 or later for setup using Wireless Accessory Configuration.

"Made for iPod," "Made for iPhone," and "Made for iPad" mean that an electronic accessory has been designed to connect specifically to iPod, iPhone, or iPad, respectively, and has been certified by the developer to meet Apple performance standards.

Apple is not responsible for the operation of this device or its compliance with safety and regulatory standards.

Please note that the use of this accessory with iPod, iPhone, or iPad may affect wireless performance.

iTunes, AirPlay, iPad, iPhone, iPod, and iPod touch are trademarks of Apple Inc., registered in the U.S. and other countries.

iPad Air and iPad mini are trademarks of Apple Inc.

App Store is a service mark of Apple Inc.



The terms HDMI, the HDMI Logo, and High-Definition Multimedia Interface are trademarks or registered trademarks of HDMI Licensing LLC in the United States and other countries.

### x.v.Color™

"x.v.Color" is a trademark of Sony Corporation.



DLNA™ and DLNA CERTIFIED™ are trademarks or registered trademarks of Digital Living Network Alliance. All rights reserved. Unauthorized use is strictly prohibited.

### Windows™

Windows is a registered trademark of Microsoft Corporation in the United States and other countries.

Internet Explorer, Windows Media Audio and Windows Media Player are either registered trademarks or trademarks of Microsoft Corporation in the United States and/or other countries.

### Android™

#### Google Play™

Android and Google Play are trademarks of Google Inc.



The Wi-Fi CERTIFIED™ Logo is a certification mark of Wi-Fi Alliance®.

The Wi-Fi Protected Setup™ Identifier Mark is a certification mark of Wi-Fi Alliance®.



The Bluetooth® word mark and logos are registered trademarks owned by Bluetooth SIG, Inc. and any use of such marks by Yamaha Corporation is under license.

### Bluetooth protocol stack (Blue SDK)

Copyright 1999-2014 OpenSynergy GmbH

All rights reserved. All unpublished rights reserved.



(For U.K., Europe, Australia and Russia models)

The unit supports DAB/DAB+ tuning.

### SILENT™ CINEMA

"SILENT CINEMA" is a trademark of Yamaha Corporation.

### MusicCast

MusicCast is a trademark or registered trademark of Yamaha Corporation.



Yamaha Eco-Label is a mark that certifies products of high environmental performance.

### Google Noto Fonts

This product uses the following fonts.

Copyright © June 2015, Google  
(<https://www.google.com/get/noto/#sans-lgc>), with Reserved Font Name Noto Sans Version 1.004.

Copyright © June 2015, Google  
(<https://www.google.com/get/noto/help/cjk/>), with Reserved Font Name Noto Sans CJK Version 1.004.

This Font Software is licensed under the SIL Open Font License, Version 1.1.

This license is available with a FAQ at: <http://scripts.sil.org/OFL>

### Explanations regarding GPL

This product utilizes GPL/LGPL open-source software in some sections. You have the right to obtain, duplicate, modify, and redistribute this open-source code only. For information on GPL/LGPL open source software, how to obtain it, and the GPL/LGPL license, refer to the Yamaha Corporation website (<http://download.yamaha.com/sourcecodes/musiccast/>).

# Specifications

The specifications of this unit are as follows.

## Input jacks

Analog Audio

- Audio x 4

Digital Audio (Supported frequencies: 32 kHz to 96 kHz)

- Optical x 1
- Coaxial x 2

Video

- Composite x 3

HDMI Input

- HDMI x 4

Other jacks

- USB x 1 (USB2.0)
- NETWORK (Wired) x 1 (100Base-TX/10Base-T)
- NETWORK (Wireless) x 1 (IEEE802.11b/g/n)

## Output jacks

Analog Audio

- Speaker Out x 7 (FRONT L/R, CENTER, SURROUND L/R, SURROUND BACK L/R\*)  
\* Note: assignment is possible. [SURROUND BACK, PRESENCE, BI-AMP (FRONT L/R), ZONE B]
- Subwoofer Out x 2 (mono x 2)
- Headphone x 1

Video

- Composite x 1

HDMI Output

- HDMI OUT x 1

## Other jacks

YPAO MIC x 1

## HDMI

HDMI Features:

- 4K UltraHD Video (include 4K/60, 50Hz 10/12bit), 3D Video, ARC (Audio Return Channel), HDMI Control (CEC), Auto Lip Sync, Deep Color, "x.v.Color", HD audio playback, Selectable HDMI input in HDMI standby mode, 21:9 Aspect Ratio, BT.2020 Colorimetry, HDR Compatible

Video Format (Repeater Mode)

- VGA
- 480i/60 Hz
- 576i/50 Hz
- 480p/60 Hz
- 576p/50 Hz
- 720p/60 Hz, 50 Hz
- 1080i/60 Hz, 50 Hz
- 1080p/60 Hz, 50 Hz, 30 Hz, 25 Hz, 24 Hz
- 4K/60Hz, 50Hz, 30 Hz, 25 Hz, 24 Hz

Audio Format

- Dolby Atmos
- Dolby TrueHD
- Dolby Digital Plus
- Dolby Digital
- DTS:X
- DTS-HD Master Audio
- DTS-HD High Resolution Audio
- DTS Express
- DTS
- DSD 2-ch to 6-ch
- PCM 2-ch to 8-ch (Max. 192 kHz/24-bit)

Content Protection: HDCP 2.2 compatible

Link Function: CEC supported

## TUNER

Analog Tuner

- [Except for U.K., Europe, Australia and Russia models]  
FM/AM x 1 (TUNER)
- [U.K. and Europe models]  
DAB/FM with Radio Data System x 1 (TUNER)
- [Australia and Russia models]  
DAB/FM x 1 (TUNER)

## USB

Capable of Mass Storage Class USB Memory

Current Supply Capacity: 1.0 A

## Bluetooth

Sink Function

- Source Device to AVR (ex. Smartphone/Tablet)
- Supported profile
  - A2DP, AVRCP
- Supported codec
  - SBC, AAC

Source Function

- AVR to Sink Device (ex. Bluetooth Headphone)
- Supported profile
  - A2DP, AVRCP
- Supported codec
  - SBC

Capable of Play/Stop Operation from Sink Device

Bluetooth version

- Ver. 2.1+EDR

Wireless output

- Bluetooth Class 2

Radio Frequency (Operational Frequency)

- 2402 MHz to 2480 MHz

Maximum Output Power (E.I.R.P)

- 3.91 dBm (2.46 mW)

Maximum communication distance

- 10 m (33 ft) without interference

## Network

PC Client Function

Compatible with DLNA ver. 1.5

AirPlay supported

Internet Radio

Wi-Fi function

- Capable of WPS by PIN Method and Push-Button-Method
- Capable of sharing with iOS devices by wireless connection
- Capable of Direct Connection with Mobile Device
- Available Security Method: WEP, WPA2-PSK (AES), Mixed Mode
- Wireless LAN Standards: IEEE 802.11 b/g/n
- Radio Frequency (Operational Frequency): 2412 MHz to 2472 MHz
- Maximum Output Power (E.I.R.P): 17.42 dBm (55.2 mW)

## Compatible Decoding Formats

Decoding Format

- Dolby Atmos
- Dolby TrueHD, Dolby Digital Plus
- Dolby Digital
- DTS:X
- DTS-HD Master Audio, DTS-HD High Resolution Audio, DTS Express
- DTS, DTS 96/24, DTS-ES Matrix 6.1, DTS-ES Discrete 6.1

Post Decoding Format

- Dolby Surround
- DTS Neo: 6 Music, DTS Neo: 6 Cinema
- Neural:X

## Audio Section

Rated Output Power (2-channel driven)

- [U.S.A. and Canada models] (20 Hz to 20 kHz, 0.09% THD, 8 Ω)
- [Other models] (20 Hz to 20 kHz, 0.09% THD, 6 Ω)
  - Front L/R 80 W+80 W
- [U.S.A. and Canada models] (1 kHz, 0.9% THD, 8 Ω)
  - Front L/R 95 W+95 W
  - Center 95 W
  - Surround L/R 95 W+95 W
  - Surround Back L/R 95 W+95 W

Rated Output Power (1-channel driven)	
<ul style="list-style-type: none"> <li>[U.S.A. and Canada models] (1 kHz, 0.9% THD, 8 <math>\Omega</math>)</li> <li>[Other models] (1 kHz, 0.9% THD, 6 <math>\Omega</math>) <ul style="list-style-type: none"> <li>– Front L/R 115 W/ch</li> <li>– Center 115 W/ch</li> <li>– Surround L/R 115 W/ch</li> <li>– Surround Back L/R 115 W/ch</li> </ul> </li> </ul>	
Maximum Effective Output Power (1-channel driven)	
<ul style="list-style-type: none"> <li>[U.S.A. and Canada models] (1 kHz, 10% THD, 8 <math>\Omega</math>) <ul style="list-style-type: none"> <li>– Front L/R, Center, Surround L/R, Surround Back L/R 140 W/ch</li> </ul> </li> <li>(1 kHz, 10% THD, 6 <math>\Omega</math>) <ul style="list-style-type: none"> <li>– Front L/R, Center, Surround L/R, Surround Back L/R 145 W/ch</li> </ul> </li> <li>[Other models] (1 kHz, 10% THD, 6 <math>\Omega</math>) <ul style="list-style-type: none"> <li>– Front L/R, Center, Surround L/R, Surround Back L/R 135 W/ch</li> </ul> </li> </ul>	
Dynamic Power (IHF)	
<ul style="list-style-type: none"> <li>[U.S.A. and Canada models] <ul style="list-style-type: none"> <li>– Front L/R (8/6/4/2 <math>\Omega</math>) 120/140/170/190 W</li> </ul> </li> <li>[Other models] <ul style="list-style-type: none"> <li>– Front L/R (6/4/2 <math>\Omega</math>) 140/170/190 W</li> </ul> </li> </ul>	
Damping Factor	
<ul style="list-style-type: none"> <li>Front L/R, 20 Hz to 20 kHz, 8 <math>\Omega</math> 100 or more</li> </ul>	
Input Sensitivity / Input Impedance	
<ul style="list-style-type: none"> <li>AV 2 etc. (1 kHz, 100 W/6 <math>\Omega</math>) 200 mV/47 k<math>\Omega</math></li> </ul>	
Maximum Input Signal	
<ul style="list-style-type: none"> <li>AV 2 etc. (1 kHz, 0.5% THD, Effect On) 2.3 V</li> </ul>	
Output Level / Output Impedance	
<ul style="list-style-type: none"> <li>SUBWOOFER 1 V/1.2 k<math>\Omega</math></li> </ul>	
Headphone Jack Rated Output / Impedance	
<ul style="list-style-type: none"> <li>AV 2 etc. (1 kHz, 50 mV, 8 <math>\Omega</math>) 100 mV/470 <math>\Omega</math></li> </ul>	
Frequency Response	
<ul style="list-style-type: none"> <li>AV 2 etc. to Front (10 Hz to 100 kHz) +0/-3 dB</li> </ul>	

Signal to Noise Ratio (IHF-A Network)	
<ul style="list-style-type: none"> <li>AV 2 etc. (DIRECT) (Input 1 k<math>\Omega</math> Shorted, Speaker Out) 110 dB or more</li> </ul>	
Residual Noise (IHF-A Network)	
<ul style="list-style-type: none"> <li>Front L/R (Speaker Out) 150 <math>\mu</math>V or less</li> </ul>	
Channel Separation	
<ul style="list-style-type: none"> <li>AV 2 etc. (Input 1 k<math>\Omega</math> Shorted, 1 kHz/10 kHz) 70 dB/50 dB or more</li> </ul>	
Volume Control	
<ul style="list-style-type: none"> <li>Range MUTE, -80 dB to +16.5 dB</li> <li>Step 0.5 dB</li> </ul>	
Tone Control Characteristics	
<ul style="list-style-type: none"> <li>Bass Boost/Cut <math>\pm</math>6 dB/0.5 dB Step at 50 Hz</li> <li>Bass Turnover 350 Hz</li> <li>Treble Boost/Cut <math>\pm</math>6 dB/0.5 dB Step at 20 kHz</li> <li>Treble Turnover 3.5 kHz</li> </ul>	
Filter Characteristics ( $f_c=40/60/80/90/100/110/120/160/200$ Hz)	
<ul style="list-style-type: none"> <li>H.P.F. (Front, Center, Surround) 12 dB/oct.</li> <li>L.P.F. (Subwoofer) 24 dB/oct.</li> </ul>	
<b>Video Section</b>	
Video Signal Type	
<ul style="list-style-type: none"> <li>[U.S.A. and Canada models] NTSC</li> <li>[Other models] PAL</li> </ul>	
Video Signal Level	
<ul style="list-style-type: none"> <li>Composite 1 V<sub>p-p</sub>/75 <math>\Omega</math></li> </ul>	
Video Maximum Input Level	
	1.5 V <sub>p-p</sub> or more
Video Signal to Noise Ratio	
	50 dB or more

## FM Section

---

Tuning Range	
• [U.S.A. and Canada models]	87.5 MHz to 107.9 MHz
• [U.K. and Europe models]	87.50 MHz to 108.00 MHz
• [Other models]	87.50 MHz to 108.00 MHz

---

50 dB Quiet Sensitivity (IHF, 1 kHz, 100% MOD.)	
• Mono	3 $\mu$ V (20.8 dBf)

---

Signal to Noise Ratio (IHF)	
• Mono	65 dB
• Stereo	64 dB

---

Harmonic Distortion (IHF, 1 kHz)	
• Mono	0.5%
• Stereo	0.6%

---

Antenna Input	
	75 $\Omega$ unbalanced

## AM section

---

Tuning Range	
• [U.S.A. and Canada models]	530 kHz to 1710 kHz

## DAB Section (U.K., Europe, Australia and Russia models)

---

Tuning Range	
	174 MHz to 240 MHz (Band III)

---

Support Audio Format	
	MPEG 1 Layer II/MPEG-4 HE-AAC v2

---

Antenna	
	75 $\Omega$ unbalanced

## General

---

Power Supply	
• [U.S.A. and Canada models]	AC 120 V, 60 Hz
• [Australia model]	AC 240 V, 50 Hz
• [U.K., Europe and Russia models]	AC 230 V, 50 Hz

---

Power Consumption	
	260 W

---

Standby Power Consumption	
• HDMI Control Off, Standby Through Off, Network Standby Off	0.1 W
• HDMI Control On, Standby Through On (No Signals), Network Standby Off	1.1 W
• HDMI Control Off, Standby Through Off, Network Standby On, Bluetooth Standby Off	
– Wired	1.7 W
– Wireless (Wi-Fi)	1.8 W
– Wireless Direct	1.8 W
• HDMI Control Off, Standby Through Off, Network Standby On (Wired), Bluetooth Standby On	1.6 W
• HDMI Control On, Standby Through On (No Signals), Network Standby On (Wireless Direct), Bluetooth Standby On	2.4 W

---

Dimensions (W x H x D)	
	435 x 161 x 330 mm (17-1/8" x 6-3/8" x 13")

---

Reference Dimensions (with wireless antenna upright)	
* Including legs and protrusions	435 x 225.5 x 330 mm (17-1/8" x 8-7/8" x 13")

---

Weight	
	8.3 kg (18.3 lbs)

\* The contents of this manual apply to the latest specifications as of the publishing date. To obtain the latest manual, access the Yamaha website then download the manual file.

Yamaha Global Site  
<http://www.yamaha.com/>

Yamaha Downloads  
<http://download.yamaha.com/>

Manual Development Group  
© 2017 Yamaha Corporation

Published 03/2017 NV-A0

YJ193A0/EN1