

# YAMAHA

# YPDR

PROFESSIONAL DISC RECORDER YPDR601/RC601

## Operating Manual

**IMPORTANT!**

Please make a note of the serial number of this unit in the space indicated below.

Model:

Serial No.:

The serial number is inscribed on the rear of the unit.  
Keep this Owner's Manual in a safe place for future reference.

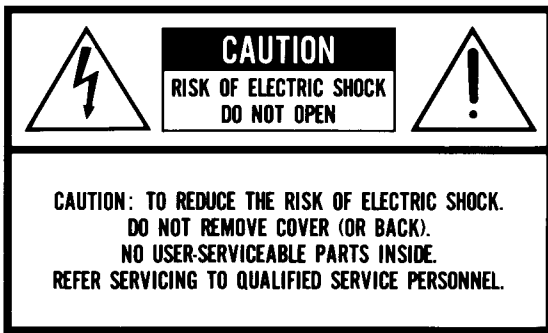

**DANGER**  
 Invisible laser radiation when open and interlock failed or defeated.  
 Avoid direct exposure to beam.

**CAUTION**  
 Use of controls or adjustments or performance of procedures other than those specified herein may result in hazardous radiation exposure.

• **Explanation of Graphical Symbols**



The lightning flash with arrowhead symbol, within an equilateral triangle, is intended to alert you to the presence of uninsulated "dangerous voltage" within the product's enclosure that may be of sufficient magnitude to constitute a risk of electric shock to persons.



The exclamation point within an equilateral triangle is intended to alert you to the presence of important operating and maintenance (servicing) instructions in the literature accompanying the appliance.

**Laser Diode Properties**

- Material: GaAlAs
  - Wavelength: 780nm
  - Emission Duration: continuous
  - Laser Output: max. 44.6μW\*
- \* This output is the value measured at a distance of about 200mm from the objective lens surface on the Optical Pick-up Block.

## WARNING: CHEMICAL CONTENT NOTICE!

The solder used in the manufacture of this product contains LEAD. In addition, the electrical/electronic and/or plastic (where applicable) components may also contain traces of chemicals found by the California Health and Welfare Agency (and possibly other entities) to cause cancer and/or birth defects or other reproductive harm.

**IMPORTANT MESSAGE:** Yamaha strives to produce products that are both user safe and environmentally "friendly". We sincerely believe that our products meet these goals. However, in keeping with both the spirit and the letter of various statutes we have included the messages shown above and others in various locations in this manual.

**DO NOT REMOVE ANY ENCLOSURE COMPONENTS!**

There are no user serviceable parts inside. All service should be performed by a service representative authorized by Yamaha to perform such service.

**FCC INFORMATION (U.S.A.)**

**1. IMPORTANT NOTICE: DO NOT MODIFY THIS UNIT!**

This product, when installed as indicated in the instructions contained in this manual, meets FCC requirements. Modifications not expressly approved by Yamaha may void your authority, granted by the FCC, to use the product.

**2. IMPORTANT:** When connecting this product to accessories and/or another product use only high quality shielded cables. Cable/s supplied with this product MUST be used. Follow all installation instructions. Failure to follow instructions could void your FCC authorization to use this product in the USA.

**3. NOTE:** This product has been tested and found to comply with the requirements listed in FCC Regulations; Part 15 for Class "A" digital devices. Compliance with these requirements provides a reasonable level of assurance that your use of this product in a commercial environment will not result in harmful interference with other electronic devices. However, operation of this product in a residential area is likely to cause interference in some form. In this case you, the user, bear the responsibility of correcting this condition.

This product generates/uses radio frequencies and, if not installed and used according to the instructions found in the users manual, may cause interference harmful to the operation of other electronic devices. Compliance with FCC

regulations does not guarantee that interference will not occur in all installations. If this product is found to be the source of interference, which can be determined by turning the unit "OFF" and "ON", please try to eliminate the problem by using one of the following measures:

Relocate either this product or the device that is being affected by the interference.

Utilize power outlets that are on different branch (circuit breaker or fuse) circuits or install AC line filter/s.

In the case of radio or TV interference, relocate/reorient the antenna. If the antenna lead-in is 300 ohm ribbon lead, change the lead-in to co-axial type cable.

If these corrective measures do not produce satisfactory results, please contact the local retailer authorized to distribute this type of product. If you can not locate the appropriate retailer, please contact \*Yamaha Corporation of America, Electronic Service Division, 6600 Orangethorpe Ave, Buena Park, CA90620.

The above statements apply ONLY to those products distributed by Yamaha Corporation of America or its subsidiaries.

## MAINS SUPPLY CORD SET AND SELECTOR SWITCH

**IMPORTANT:** The Yamaha Professional Disc Recorder YPDR601 is equipped with a Mains select switch (100-120 or 220-240 VAC). Please make sure that this switch is set for the Mains supply voltage available in your area before you make any connections to the Mains supply.

**Note:** The 220-240 Mains selection option is not appropriate for all market areas and is specifically not intended for use in the U.S.A. and Canada. If you take this product to areas where the 100-120 VAC Mains supply is not available, please contact the local Yamaha Distributor or the Yamaha Service Center for cord set information applicable to the specific area.

### IMPORTANT NOTICE FOR THE UNITED KINGDOM

#### Connecting the Plug and Cord

#### WARNING: THIS APPARATUS MUST BE EARTHED

IMPORTANT. The wires in this mains lead are coloured in accordance with the following code:

GREEN-AND-YELLOW : EARTH  
BLUE : NEUTRAL  
BROWN : LIVE

As the colours of the wires in the mains lead of this apparatus may not correspond with the coloured markings identifying the terminals in your plug proceed as follows:

The wire which is coloured GREEN-AND-YELLOW must be connected to the terminal in the plug which is marked by the letter E or by the safety earth symbol  $\perp$  or coloured GREEN or GREEN-AND-YELLOW.

The wire which is coloured BLUE must be connected to the terminal which is marked with the letter N or coloured BLACK.

The wire which is coloured BROWN must be connected to the terminal which is marked with the letter L or coloured RED.

### Bescheinigung des Importeurs

Hiermit wird bescheinigt, daß der/die/das

PROFESSIONAL DISC RECORDER Typ YPDR601/RC601  
(Gerät, Type, Bezeichnung)

in Übereinstimmung mit den Bestimmungen der

VERFÜGUNG 1046/84  
(Amtsblattverfügung)

funk-entstört ist.

Der Deutschen Bundespost wurde das Inverkehrbringen dieses Gerätes angezeigt und die Berechtigung zur Überprüfung der Serie auf Einhaltung der Bestimmungen eingeräumt.

Yamaha Europa GmbH  
Name des Importeurs

### FOR CANADIAN CUSTOMER

THIS DIGITAL APPARATUS DOES NOT EXCEED THE "CLASS A" LIMITS FOR RADIO NOISE EMISSIONS FROM DIGITAL APPARATUS SET OUT IN THE RADIO INTERFERENCE REGULATION OF THE CANADIAN DEPARTMENT OF COMMUNICATION.

### POUR LES CONSOMMATEURS CANADIENS

LE PRESENT APPAREIL NUMERIQUE N'EMET PAS DE BRUITS RADIOELECTRIQUES DEPASSANT LES LIMITES APPLICABLES AUX APPAREILS NUMERIQUES DE LA "CLASS A" PRESCRITES DANS LE REGLEMENT SUR LE BROUILLAGE RADIOELECTRIQUE EDICTE PAR LE MINISTERE DES COMMUNICATIONS DU CANADA.

Varningsanvisning för laserstrålning. Placerad i apparaten.

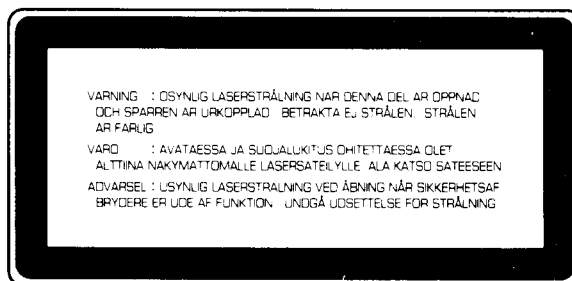

Klassmärkning för Finland

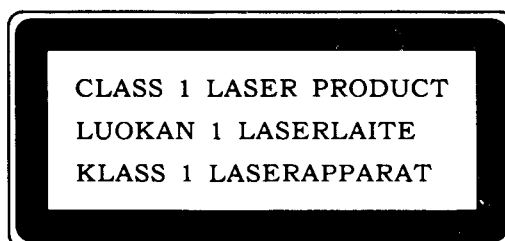

### ADVARSEL

Usynlig laserstrålning ved åbning. Undgå udsættelse for stråling.

### VAROITUS

Laiteen käyttäminen muulla kuin tässä käyttöohjeessa mainitulla tavalla saattaa altistaa käyttäjän turvallisuusluokan 1 ylittävälle näkymättömälle lasersäteilylle.

### VARNING

Om apparaten används på annat sätt än i denna bruksanvisning specificerats, kan användaren utsättas för osynlig laserstrålning, som överskrider gränsen för laserklass 1.

This product complies with the radio frequency interference requirements of the Council Directive 82/499/EEC and/or 87/308/EEC.

Cet appareil est conforme aux prescriptions de la directive communautaire 87/308/CEE.

Diese Geräte entsprechen der EG-Richtlinie 82/499/EWG und/oder 87/308/EWG.

Denne apparat overholder det gældende EF-direktiv vedrørende radiostøj.

Questo apparecchio è conforme al D.M.13 aprile 1989 (Direttiva CEE/87/308) sulla soppressione dei radiodisturbi.

Este producto está de acuerdo con los requisitos sobre interferencias de radio frecuencia fijados por el Consejo Directivo 87/308 CEE.

Dit product voldoet aan de EEG normen betreffende radio-frekwentie storingen 82/499/EEG en/of 87/308/EEG.

The YPDR is subject to COCOM regulations.

If you intend exporting this product, you should follow the necessary procedures to obtain prior approval from the government of the country from which the YPDR is being exported.

<b>1 • Introduction</b>	
1.1 Features .....	3
1.2 TOC PRE .....	3
1.3 TOC AFTER .....	3
1.4 Applications .....	4
<b>2 • Installation and precautions</b>	
2.1 Installation .....	5
2.2 Head locking system .....	5
2.3 General care and maintenance .....	6
2.4 Warm-up and condensation .....	6
2.5 Care of discs .....	6
2.6 Copyright .....	7
<b>3 • Main unit (YPDR601)</b>	
3.1 Front panel .....	8
1 Disc tray .....	8
2 OPEN/CLOSE key .....	8
3 POWER indicator .....	8
4 C1 indicator .....	8
5 RECORD indicator .....	8
6 DISC indicator .....	8
7 ERROR indicator .....	9
3.2 Rear panel .....	9
1 HIGH/LOW switch .....	9
2 LEVEL ADJ (Lch, Rch) .....	9
3 ANALOG IN .....	9
4 ANALOG OUT .....	10
5 SYNC (IN, OUT) .....	10
6 DIGITAL AES/EBU (IN) .....	10
7 DIGITAL AES/EBU (OUT) .....	10
8 D.IN (CH1, CH2) .....	10
9 Cooling fan .....	10
10 Ground (earth) terminal .....	10
11 POWER switch .....	10
12 VOLTAGE SELECTOR .....	10
13 AC IN .....	10
14 DRIVE ID switch .....	10
15 I/O IN .....	10
16 REMOTE connector .....	11
17 I/O OUT .....	11
18 Parallel I/O connector .....	11
19 LOCK/RELEASE .....	11
<b>4 • Remote controller (RC601)</b>	
4.1 Front panel .....	12
1 DIGITAL IN/EMPHASIS/COPY PROHIBIT/ALARM indicators .....	12
2 Display .....	13
3 Display function indicators .....	13
4 INDEX keys .....	13
5 DISPLAY .....	13
6 LINE .....	13
7 INPUT/REPRO .....	13
8 Meters .....	13
9 Transport controls .....	14
10 TRACK keys .....	14
11 SEARCH .....	14
12 REHEARSAL .....	14
4.2 Rear panel .....	15
1 PHONES connector .....	15

## Table of Contents

---

2 PHONES LEVEL.....	15
3 DRIVE SELECT.....	15
4 DIP switch bank.....	15
EMPHASIS .....	15
PEAK HOLD .....	15
COPY GUARD .....	15
EXT W. SYNC .....	15
5 INPUT SELECT switches.....	16
6 TOC switches.....	16
7 POWER switch.....	16
8 CONTROL connector.....	16
9 AC IN.....	16
<b>5 • Connection</b>	
5.1 Audio connections .....	17
5.2 Single-recorder connection .....	17
5.2.1 Analog input level adjustment .....	18
5.3 Multi-recorder connection .....	19
<b>6 • Operation</b>	
6.1 Playback of previously-recorded CDs .....	21
6.1.1 Disc type displays .....	21
6.1.2 Track and index location .....	22
6.1.3 Search mode .....	22
6.2 Recording fixed tracks (TOC PRE mode) .....	22
6.2.1 Recording the TOC .....	23
6.2.2 Track start .....	23
6.2.3 Rehearsing an audio recording .....	23
Levels .....	24
6.2.4 Audio recording .....	24
REC MUTE .....	25
STOP/PAUSE .....	25
AUTO PAUSE .....	25
6.2.5 Lead-out .....	25
6.3 Recording variable tracks (TOC AFTER mode) .....	25
6.3.1 Track start .....	26
Minimum track lengths .....	26
6.3.2 Rehearsal .....	26
6.3.3 Audio recording .....	26
REC MUTE .....	27
PAUSE .....	27
STOP .....	27
6.3.4 Recording the TOC .....	27
6.4 Multi-recorder recording .....	27
6.5 Duplication .....	28
<b>7 • Errors</b>	
<b>8 • Technical specifications</b>	
8.1 Controller (RC601) .....	31
8.2 Recorder Unit (YPDR601) .....	32
8.3 50-pin I/O connector pinout .....	33
8.4 Serial REMOTE (D-sub 9-pin) .....	33
8.5 PARALLEL I/O (D-sub 15-pin) .....	34
8.5.1 Parallel I/O timing chart .....	35

## **1 • Introduction**

The Yamaha Professional Disc Recorder (YPDR) system is composed of two parts: the YPDR601 Disc Recorder Unit (referred to in this manual as “the main unit”, and the RC601 remote controller (referred to in this manual as “the controller”. The two are connected using a 5m (16ft) 50-pin cable (supplied).

### **1.1 Features**

- The YPDR system allows the recording of discs which may be replayed on standard CD players.
- Up to 99 tracks may be recorded on one disc, and up to 99 index markers may be written within each track.
- Recording of a disc need not be continuous audio data can be written from different sources (master tapes, etc).
- The operation of the YPDR system is similar to the operation of a tape-recorder, making disc production analogous to the assembly of a master tape.
- Audio sources may be analog or digital (either SDIF-II or AES/EBU format).
- Monitoring may be carried out while recording, either of the source or off-disc. The monitor output may be analog or digital (AES/EBU format).
- Up to seven YPDR601 recorder units may be linked together and controlled from one controller for parallel recording, or for disc duplication.
- The YPDR system provides two recording modes, as described below:

### **1.2 TOC PRE**

In this mode, the YPDR system writes a TOC (Table Of Contents) before any audio data has been recorded. A TOC which references 99 tracks is written. All tracks are the same length, and the length of each track may be set to 10 seconds or 30 seconds (selectable from the controller).

If the 30 second track length is selected, the total recording time available on a disc is 49 minutes, 30 seconds, and if the 10 second track length is selected, the total recording time available on a single disc is 16 minutes, 30 seconds.

In this TOC PRE mode, the TOC is first recorded, and then audio recording is carried out. The disc may be removed from the YPDR and replayed on a commercial CD player. If the disc is not full, recording of further tracks may be carried out on the YPDR for subsequent replay on CD players.

### **1.3 TOC AFTER**

This mode varies from the TOC PRE mode in that TOC data is written on the disc after all audio data has been recorded. This allows for variable track lengths, but means that the disc cannot be played on standard CD players until the TOC has been written. The YPDR, however, is capable of replaying audio data from discs which do not yet have a TOC written to them. Once the TOC has been written, no further recording of audio data which can be read by a commercial CD player is possible.

The maximum length of audio data which can be written in the TOC AFTER mode is 74 minutes, dependent on media.

### 1.4 Applications

The YPDR system is suitable for all professional audio applications where speedy production of a limited quantity of discs is required. Such applications include:

- Pre-recorded public announcement systems (airports, etc) can use disc rather than tape.
- Broadcasting stations can store jingles, commercials, etc on disc, rather than on tape cartridge.
- Radio drama and AV post-production facilities can make up custom disc libraries of sound effects.
- Recording studios may choose to provide “demo discs” rather than “demo tapes” for their clients.



## 2 • Installation and precautions

The following should be included with each YPDR system:

RC601 Remote Controller.....	1
YPDR601 Professional Disc Recorder .....	1
Power cords .....	2
5m (16ft) 50-way connection cable .....	1
Rack-mounting ears for main unit .....	1 set
Terminator block .....	1

You will also need a supply of blank discs (available from your Yamaha supplier).

### 2.1 Installation

The main unit may be rack-mounted (3U of rack space is required) or free-standing. To mount the main unit in a rack, make sure the head is locked, and remove the feet from the bottom of the unit. Next, remove the fixing screws from the main unit, and attach the supplied rack-mounting ears, as shown in the illustrations below:

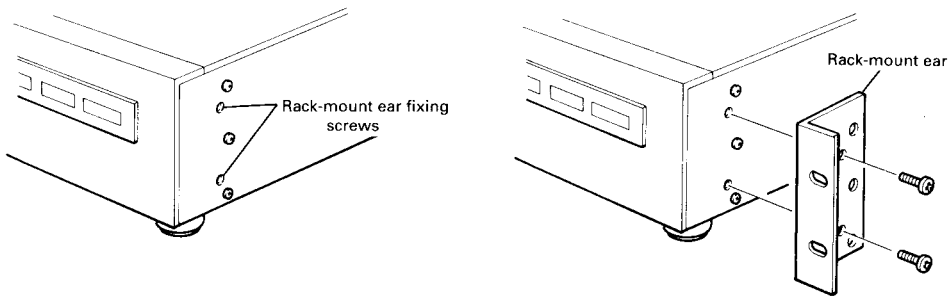

There is a voltage selector switch at the rear of the main unit. Two positions are available: 100-120V and 220-240V (both AC). Make sure that the switch is in the position corresponding to your local AC voltage.

The controller will accept voltages from 100VAC to 240VAC. No voltage regulation setting is necessary.

As with all pieces of precision electronic equipment, follow the following rules when using the YPDR: do not subject the equipment to shocks or vibration, avoid extremes of temperature and humidity, avoid use in a dusty environment, and allow adequate ventilation when in operation (the main unit is fitted with a fan make sure that this is not blocked).

### 2.2 Head locking system

**IMPORTANT!** The main unit is fitted with a laser head lock system. The head should be locked whenever the unit is transported or moved, even slightly.

Conversely, the head must be unlocked before the unit is operated.

## 2 • Installation and precautions - General care and maintenance

---

To lock and unlock the head, use the slider on the bottom of the main unit (see the illustration below):

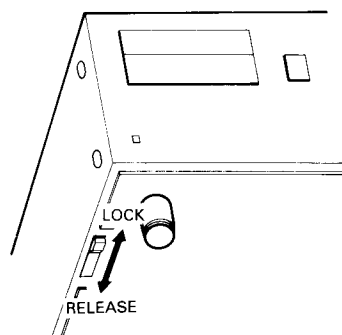

### 2.3 General care and maintenance

The YPDR is a precision piece of electronic equipment. Avoid exposing the YPDR to extremes of temperature or humidity.

Avoid exposing the YPDR to a dusty or smoke-filled environment. Clean the surfaces of the YPDR with a dry, lint-free cloth. Do not use spray cleaners, thinners or solvents. A little mild detergent applied to a slightly damp cloth may be used to remove stubborn stains or grease marks.

There are no user-serviceable parts inside either the main unit or the controller. Do not disassemble the YPDR. Refer to a Yamaha service center for any repairs or adjustments.

**ALWAYS** use the head lock system when transporting or moving the YPDR, even for a short distance.

When recording, only use blank discs of a type recommended by YAMAHA. Use of any other kind of disc may not give satisfactory results, and may even result in damage to the YPDR.

### 2.4 Warm-up and condensation

The main unit requires 30 minutes after power-on before it can be used. Allow this amount of time after switching on the unit before attempting recording.

If the main unit is brought into a warm room from a cold environment, internal condensation may occur. Allow between 1 and 2 hours for the unit to acclimatize before attempting operation.

### 2.5 Care of discs

Optical audio discs and CDs are robust storage media, but the rules below should be followed in order to extend their usable lifetime:

- Do not expose discs to direct sunlight or bright light of any kind, and keep them away from strong sources of heat. Avoid storage or use in places which have a high humidity. If the discs become damp, allow them to dry naturally, or use an air stream to dry them.
- Before using a disc for recording, remove any dust particles, etc. using an air stream (gently blow). If any dust particles cannot be removed using this method, clean the disc with a lint-free cloth. Wipe the non-label side of the disc radially from center to edge. Do not wipe in a circular path. Do

not use thinners, alcohol or solvent to clean discs. Allow the discs to dry naturally, or use an air stream to dry them. Do not use a cloth.

- Do not bend or scratch discs. To avoid mechanical damage to discs, always store them in their cases.
- When labelling discs, do not stick labels or paper to the disc. Label them by writing on the label side only with a fiber-tip marker. The use of any other writing implement may damage the disc.

### 2.6 Copyright

**NOTE**

Please check the copyright laws in your country to record from records, compact discs, radio, etc. Recording of copyright material may infringe copyright laws.

## 3 • Main unit (YPDR601)

The main unit houses the disc transport, recording and replay components, and the audio connections to the sources and the monitoring system.

### 3.1 Front panel

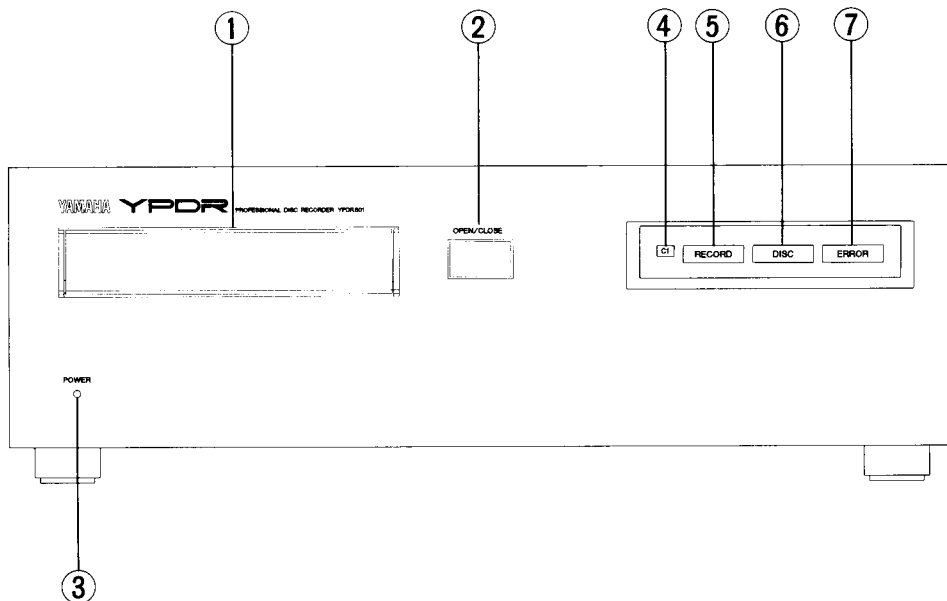

#### ① Disc tray

The disc tray holds discs for playing and recording. Discs are placed in the tray with the label upwards. The tray is opened and closed using the OPEN/CLOSE key (2).

#### ② OPEN/CLOSE key

This key opens and closes the disc tray (1).

#### ③ POWER indicator

When power is applied to the main unit (using the rear panel POWER switch (11)), this indicator will be lit.

#### ④ C1 indicator

This indicator lights briefly when a C1 (single-symbol) error occurs. If many C1 errors occur together, this indicator will light continuously.

#### ⑤ RECORD indicator

This indicator lights when either audio or TOC data is being recorded.

#### ⑥ DISC indicator

This indicator lights steadily when a disc has been inserted into the disc tray, the disc tray has been closed, and the unit is ready for playback or recording. When a disc has been inserted in the disc tray, this indicator will flash until the main unit is ready to start recording or playing back.

## ⑦ ERROR indicator

If a non-recoverable error occurs, this indicator will light. Press the TrINC and DISPLAY keys on the controller to determine the kind of error which has occurred (explained in "Errors" on page 30).

## 3.2 Rear panel

The rear panel of the main unit is where audio and control connections are made.

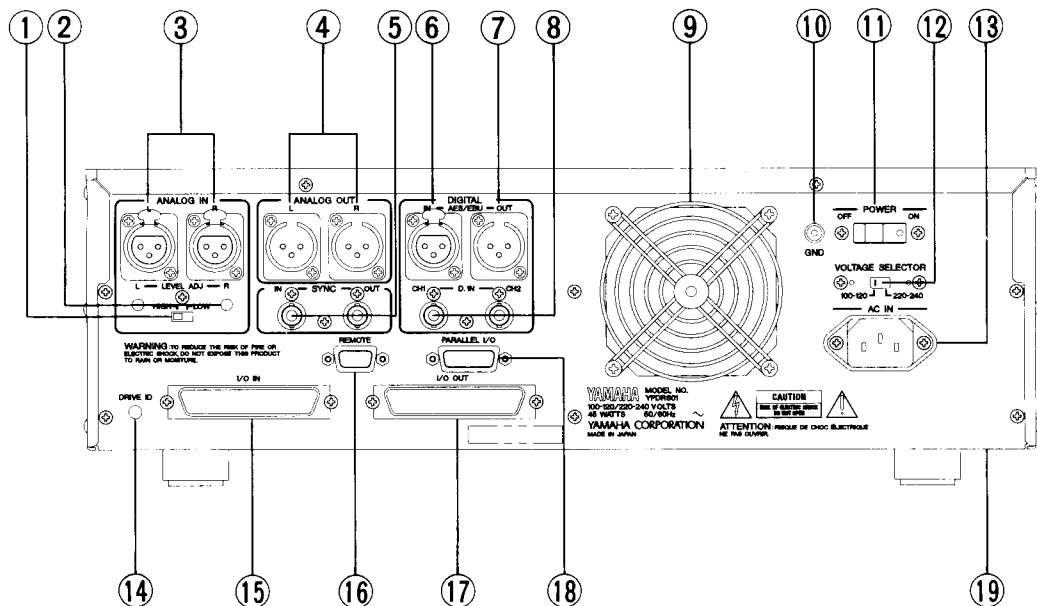

## ① HIGH/LOW switch

This switch is used with the analog inputs, to allow the matching of the recorder input circuitry with the analog source. The two positions correspond to:

Position	Nominal level	Maximum before clipping	Impedance
HIGH	+4dBm	+24dBm	10k $\Omega$
LOW	-9dBm	+11dBm	50k $\Omega$

Both positions are adjustable  $\pm 3$ dB using the LEVEL ADJ (Lch, Rch) (2).

## ② LEVEL ADJ (Lch, Rch)

These two trimmer controls allow the fine adjustment of signal levels from the analog inputs to the recording circuitry. The range is  $\pm 3$ dB from the center position (fully counter-clockwise gives -3dB, fully clockwise gives +3dB).

## ③ ANALOG IN

These two XLR-type connectors allow the input of balanced analog signals at levels determined by the HIGH/LOW switch (1) and LEVEL ADJ (Lch, Rch) (2).

### 3 • Main unit (YPDR601) - Rear panel

---

All XLR-type (analog and digital) connectors on the YPDR are wired as follows:

Pin 1	Shield (ground)
Pin 2	Hot (+)
Pin 3	Cold (-)

#### ④ ANALOG OUT

These two XLR-type connectors provide analog output signals (nominal -2dBm, maximum before clipping +18dBm, 150Ω) to the monitoring system.

These connectors are wired in the same way as the ANALOG IN (3)).

#### ⑤ SYNC (IN, OUT)

These BNC connectors are used for the input and output of a 44.1kHz word sync signal.

#### ⑥ DIGITAL AES/EBU (IN)

This XLR-type connector is used to input AES/EBU format digital audio data. The signal is balanced. Both stereo channels are carried through one connector. See ANALOG IN (3) for details of the wiring.

#### ⑦ DIGITAL AES/EBU (OUT)

This XLR-type connector is used to output AES/EBU format digital audio data. The signal is balanced. Both stereo channels are carried through one connector. See ANALOG IN (3) for details of the wiring.

#### ⑧ D.IN (CH1, CH2)

These BNC connectors are used to input digital audio data in the SDIF-II format.

#### ⑨ Cooling fan

Do not block this fan outlet, otherwise overheating may occur, with possible subsequent damage to the unit.

#### ⑩ Ground (earth) terminal

This provides a chassis ground (earth) for the main unit.

#### ⑪ POWER switch

Rocker switch for supplying power to the main unit.

#### ⑫ VOLTAGE SELECTOR

Make sure that this is set to either 100-120 or 220-240 (VAC), depending on your local power supply.

#### ⑬ AC IN

AC power is supplied to the main unit through this connector.

#### ⑭ DRIVE ID switch

When using only one main unit in a system, this should be set to "0". See the section on "Multi-recorder connection" on page 19 for details of multi-recorder setups, and details of when this switch should be set to other values.

#### ⑮ I/O IN

This is used with the supplied 50-way cable to connect the RC601 controller. When using a multi-recorder setup, the I/O OUT connector is used to connect

recorders together. See the section on "Multi-recorder connection" on page 19 for details.

#### ⑩ REMOTE connector

This 9-pin serial connector is used to transmit remote control commands. A source machine can receive remote "PLAY" and "STOP" commands issued from this connector.

To use this REMOTE connector with a DMR8 or DRU8, make sure that the remote protocol on the DMR8 or DRU8 is set to Type 2.

#### ⑪ I/O OUT

When used in a single-recorder configuration (see "Single-recorder connection" on page 17), this connector should be terminated with the supplied 50-pin terminator. In a multi-recorder configuration (see "Multi-recorder connection" on page 19), this is used to "daisy-chain" recorders together. The last unit in the chain is must be terminated.

#### ⑫ Parallel I/O connector

This parallel general purpose interface (GPI) connector is used to transmit and receive remote control commands such as PLAY, PAUSE and STOP. In addition, track and index increment functions can be remotely controlled. See "PARALLEL I/O (D-sub 15-pin)" on page 34 for details of the connection.

#### ⑬ LOCK/RELEASE

As described in "Head locking system" on page 5, this lever is used to lock the laser head when transporting or moving the recorder unit.

## 4 • Remote controller (RC601)

### 4.1 Front panel

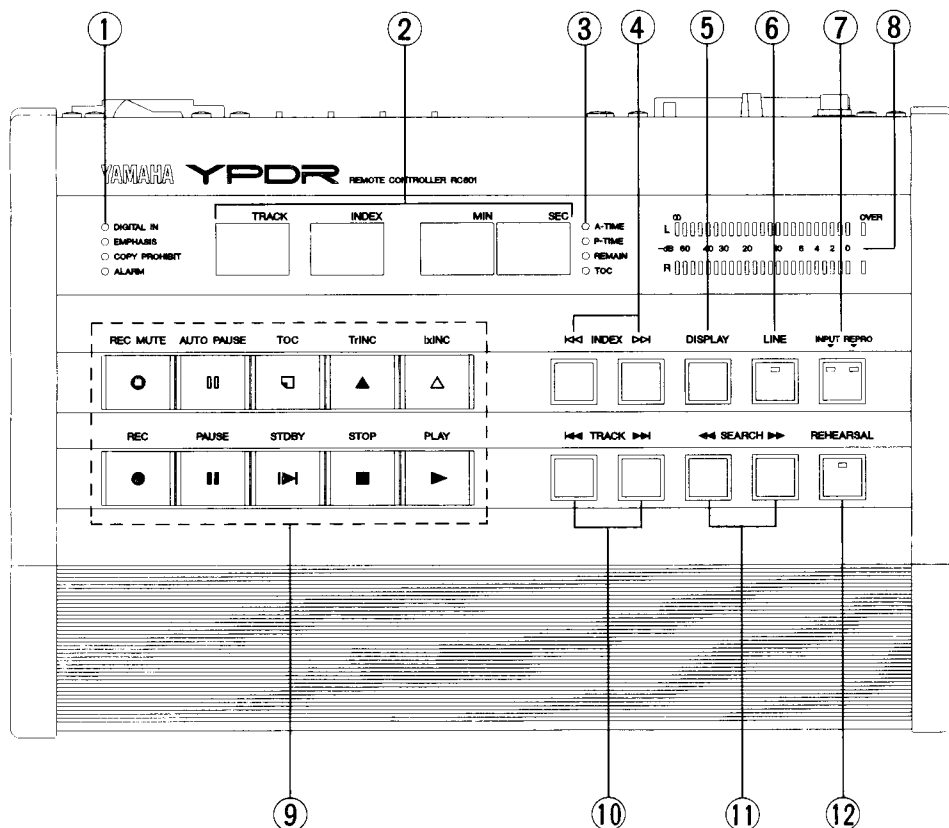

#### ① DIGITAL IN/EMPHASIS/COPY PROHIBIT/ALARM indicators

These indicators show the status of the recorder unit in various circumstances:

The DIGITAL IN indicator lights when the INPUT SELECT switches (5) are set to DIGITAL. The indicator will not light when a disc is being played back.

The EMPHASIS indicator shows that emphasis has been applied (the EMPHASIS switch is ON), when recording from an analog source. If a digital source is being used, this indicator will reflect the status of the EMPHASIS flag in the digital source.

The COPY PROHIBIT indicator will light if an analog source is used, and the COPY GUARD switch is set to ON. When a digital source is used, the following conditions apply:

- i) If the copy-protect flag is set on the source, the position of the rear panel COPY GUARD switch has no effect, the copy-protect flag will be written to disc, and the indicator will flash.
- ii) If the copy-protect flag is not set on the source, and the rear panel COPY GUARD switch is set to ON, the copy-protect flag will be written to disc, and the indicator will light.



- iii) If the copy protect flag is not set on the source, and the rear panel COPY GUARD switch is set to OFF, the copy-protect flag will not be written to disc, and the indicator will not light.

The ALARM indicator lights if an error condition occurs. Press the TrINC and DISPLAY keys simultaneously to determine the error (see "Errors" on page 30 for details).

### ② Display

This LED display indicates the track and index number of the current disc, as well as the time in minutes and seconds. The TRACK display is also used to show error codes. When a disc is loaded, the disc's format (recording method) is shown. The function of the time display (minutes and seconds) can be changed using the DISPLAY key. The selected function is shown on the Display function indicators (3).

### ③ Display function indicators

These indicators show which function is currently displayed by the "minutes" and "seconds" display LEDs (2).

When A-TIME is lit, the absolute time of the current position on the disc is displayed.

When P-TIME is lit, the time of the currently selected track ("Program") is displayed.

REMAIN shows the amount of time available for recording on the disc, or when playing back, the amount of recorded material which remains.

When TOC is lit, then the time of the start of the track is displayed.

### ④ INDEX keys

When the disc is in PLAY mode, these keys can be used to position the head at an index marker within a track, so that replay will start from that point.

### ⑤ DISPLAY

Repeated presses of this key will cycle the display (2) through the four display modes as shown by the display function indicators (3).

### ⑥ LINE

This key enables or disables the signal output from the main unit ANALOG OUT and DIGITAL AES/EBU connectors. When output is enabled, the indicator will light. The source of this signal is determined by INPUT/REPRO (7).

If the internal lock to the PLL is lost, the LINE key will continue to light, but the output (analog and digital) will be lost. In the case of an AES/EBU input, the AES/EBU signal will appear at the DIGITAL AES/EBU (OUT) (7) output, but the ALARM indicator will be lit.

### ⑦ INPUT/REPRO

When the output is enabled (the LINE key is on), this key enables the selection of monitoring between the input source (the green indicator will light) or off-disc REPRO (the red indicator will light). Switching to the appropriate monitor source is done automatically by the YPDR when possible (eg pressing PLAY will switch to REPRO if this has not already been selected).

### ⑧ Meters

These 24-segment bargraph meters indicate the level of the signal currently being monitored. Care should be taken to avoid lighting the top OVER segment,

as this indicates digital clipping. A PEAK HOLD function for these meters is available through a rear panel switch. Note that this peak hold function is not a "permanent" peak hold - the peak segments of the meters "drop back" after a few seconds.

### ⑨ Transport controls

The bottom row of these controls are similar to the transport controls on a tape recorder. STOP and PAUSE work in the same way as they do for a tape recorder. PLAY starts disc playback, and REC and PLAY together start the recording of audio data. However, for data to be recorded (either audio or TOC), the STDBY key must first be pressed in order to position the laser.

The top row of transport keys provide additional functions. The REC MUTE mutes the input signal to the recorder. The AUTO PAUSE key is used in the TOC PRE mode to complete recording of the pre-defined track (this key has no function in the TOC AFTER mode). The TOC key is used with the RECORD key to record TOC information in either the TOC PRE or TOC AFTER modes, and the TrINC and IxINC are used to write track and index information respectively, in real time. In TOC PRE mode, the TrINC key has no function, as track information is pre-written.

### ⑩ TRACK keys

These keys are used when the disc is stopped or playing, and allow setting of a track, to play the disc from the selected track.

### ⑪ SEARCH

These keys may be used when the disc is paused or playing. They allow searching for a particular point on the disc within a track by ear, rather than by index position (similar to CUE and REVIEW on a tape recorder).

### ⑫ REHEARSAL

The rehearsal mode tests the cue point of the source machine. Press this key (which will light) to go into and out of rehearsal mode. When in rehearsal mode, pressing PLAY and REC simultaneously will start the YPDR in rehearsal mode, which will stop automatically after 10 seconds.

The appropriate "PLAY" and "STOP" commands are transmitted from the REMOTE connector (16) and Parallel I/O connector (18) to the source machine, allowing monitoring of the record start point.

## 4.2 Rear panel

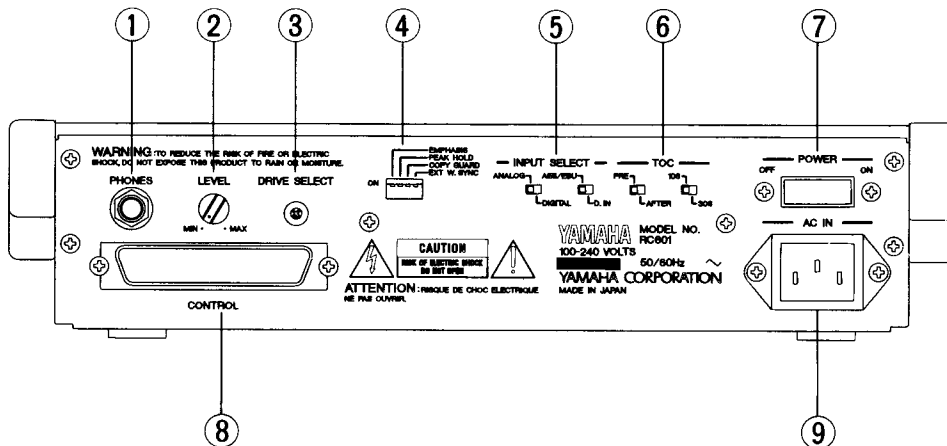

### ① PHONES connector

A stereo 1/4" connector for headphone monitoring of the signal selected using the INPUT/REPRO key on the front panel.

### ② PHONES LEVEL

A level control for the headphones connected to the PHONES connector (1). This control has no effect on the output level from the main unit.

### ③ DRIVE SELECT

When used with a single-recorder configuration, this rotary switch should be set to "0". When used in a multi-recorder setup, this switch should be set to the number of recording units being used, minus 1 (eg if three units are being used, this should be set to "2").

### ④ DIP switch bank

The four switches in this bank have the following functions:

#### EMPHASIS

When this is set ON (up), and an analog source is being used, emphasis will be added to the signal recorded on the disc. When a digital source is used, this switch has no effect (emphasis will be recorded depending on the presence or absence of emphasis in the digital source).

#### PEAK HOLD

When set to ON, the meters on the front panel will act as peak hold meters (the highest level will be displayed for a short time before "falling back") When OFF, the meters will act as momentary peak meters.

#### COPY GUARD

This switch enables or disables the writing of the copy-protection flag.

#### EXT W. SYNC

When using an analog source or an SDIF-II digital source, this selects either external word clock synchronization (ON) or internal word clock synchronization (OFF). When using an AES/EBU digital source, this switch has no effect, and the YPDR will synchronize to the source.

### ⑤ INPUT SELECT switches

These determine the type of source. The first switch allows selects either analog or digital input, and the second selects the type of digital source: either AES/EBU or SDIF-II (D.IN). If the first switch is set to ANALOG, the position of the second switch has no effect.

### ⑥ TOC switches

These determine the recording mode, as explained in the first section of this manual ("TOC PRE" on page 3 and "TOC AFTER" on page 3). The first switch allows the choice of TOC PRE (99 fixed-length tracks) or TOC AFTER (a variable number of variable-length tracks), and the second switch allows the selection of either 10 or 30 seconds as the fixed track length when in TOC PRE mode. When the first switch is set to AFTER, the position of the second switch has no effect.

### ⑦ POWER switch

This rocker switch controls the power to the controller (independent of the main unit).

### ⑧ CONTROL connector

Use the supplied 50-conductor cable to connect the controller to the main unit's I/O IN (15).

### ⑨ AC IN

This is the connector for the AC power cord (supplied)

## 5 • Connection

NOTE: Make all control and audio connections before connecting power to either the main unit or the controller. If power connections have already been made, and the system is being re-configured, make sure all components on the system are turned OFF before proceeding.

### 5.1 Audio connections

The YPDR may be connected to any monitoring system using the -2dB ANALOG OUT (4) connectors.

Headphone monitoring is possible using the headphone output at the rear of the controller. This level from this output can be controlled using the level control beside the output.

While recording, it may be necessary to adjust the volume of the signal sent to the main unit (either analog or digital). This is best achieved by routing the source signal through a mixing console (in the case of a digital signal, a console such as the YAMAHA DMC1000 is ideal).

### 5.2 Single-recorder connection

This configuration is used when recording from a stereo source onto disc.

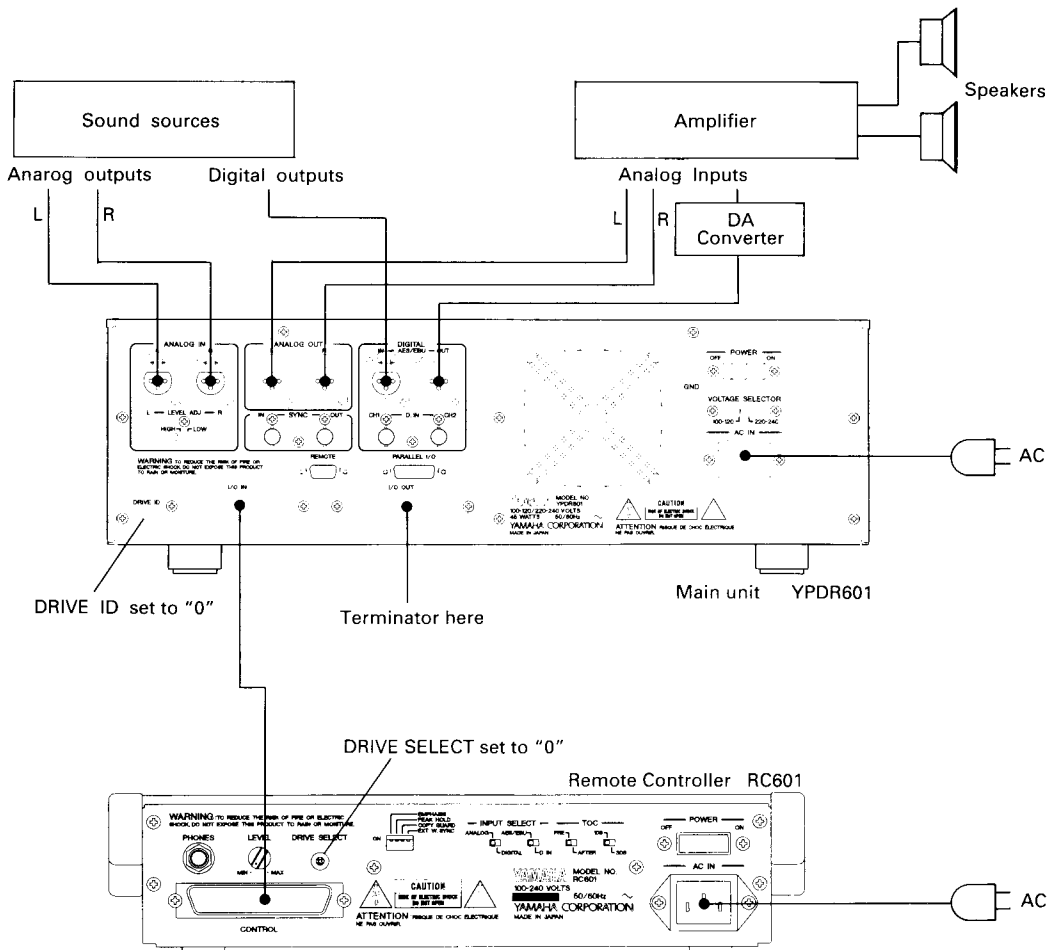

- Set the DRIVE SELECT switch on the controller to "0".

## 5 • Connection - Single-recorder connection

---

- Set the DRIVE ID switch on the main unit to “0”.
- Connect the CONTROL connector of the controller to the I/O IN of the main unit.
- Connect the terminator block to the I/O OUT of the main unit.
- Connect the audio source. When an analog source is used, the controller INPUT SELECT ANALOG/DIGITAL switch should be set to ANALOG (the position of the other switch has no effect).
- When an AES/EBU digital source is used, connect the XLR AES/EBU IN to the source. Make sure the controller INPUT SELECT switches are set to DIGITAL and AES/EBU.
- When an SDIF-II source is used, connect the source to the two BNC D.IN connectors. Make sure that the controller INPUT SELECT switches are set to DIGITAL and D.IN
- If SDIF-II is to be used as the input format, SYNC (word clock) connections should be made. The YPDR can be used as a word clock master or slave.
- If the YPDR is to be used as a master, connect the YPDR SYNC OUT to the word clock input of the source. Set the controller EXT W.SYNC DIP switch to OFF, and set the source to receive external word clock information.
- If the YPDR is to be used as a word clock slave, connect the SYNC IN of the YPDR to the word clock output of the source device. Set the controller EXT W.SYNC DIP switch to ON, and set the source to transmit word clock information.
- Connect the YPDR main unit ANALOG OUT connectors or AES/EBU connector to the monitoring system.
- If the YPDR is to be used for the remote control of a source machine such as the DMR8, connect a 9-way remote cable between the REMOTE of the main unit and the REMOTE of the control slave.
- If 2-way parallel communication is to be used, connect the D-sub 15-pin PARALLEL I/O to the other device.
- Connect the power cords.

### 5.2.1 Analog input level adjustment

- Set the level of the source output to the nominal level.
- Set the master fader of the console (if used) to the nominal level.
- Set the HIGH/LOW switch on the rear of the main unit to the appropriate position (HIGH=+4dB, LOW=-9dB, both nominal levels).
- Play the source through the YPDR system, making sure that the LINE key on the controller is on, and the INPUT/REPRO key is set to INPUT.
- Adjust the  $\pm 3$ dB trimmer controls on the rear of the main unit so that the loudest sections of the program material go to the “0” segment, but do not light the OVER segment of the controller meters.
- If, after adjusting the trimmers to add 3dB of attenuation, the “OVER” segment still lights, it may be necessary to “back off” the source output level by a few dB.

### 5.3 Multi-recorder connection

This configuration allows the simultaneous recording of multiple discs. The principles for multi-recorder operation are essentially the same as for single-recorder operation. Since the 50-way cable carries digital audio as well as control information, up to seven recorder units may be "daisy-chained" together.

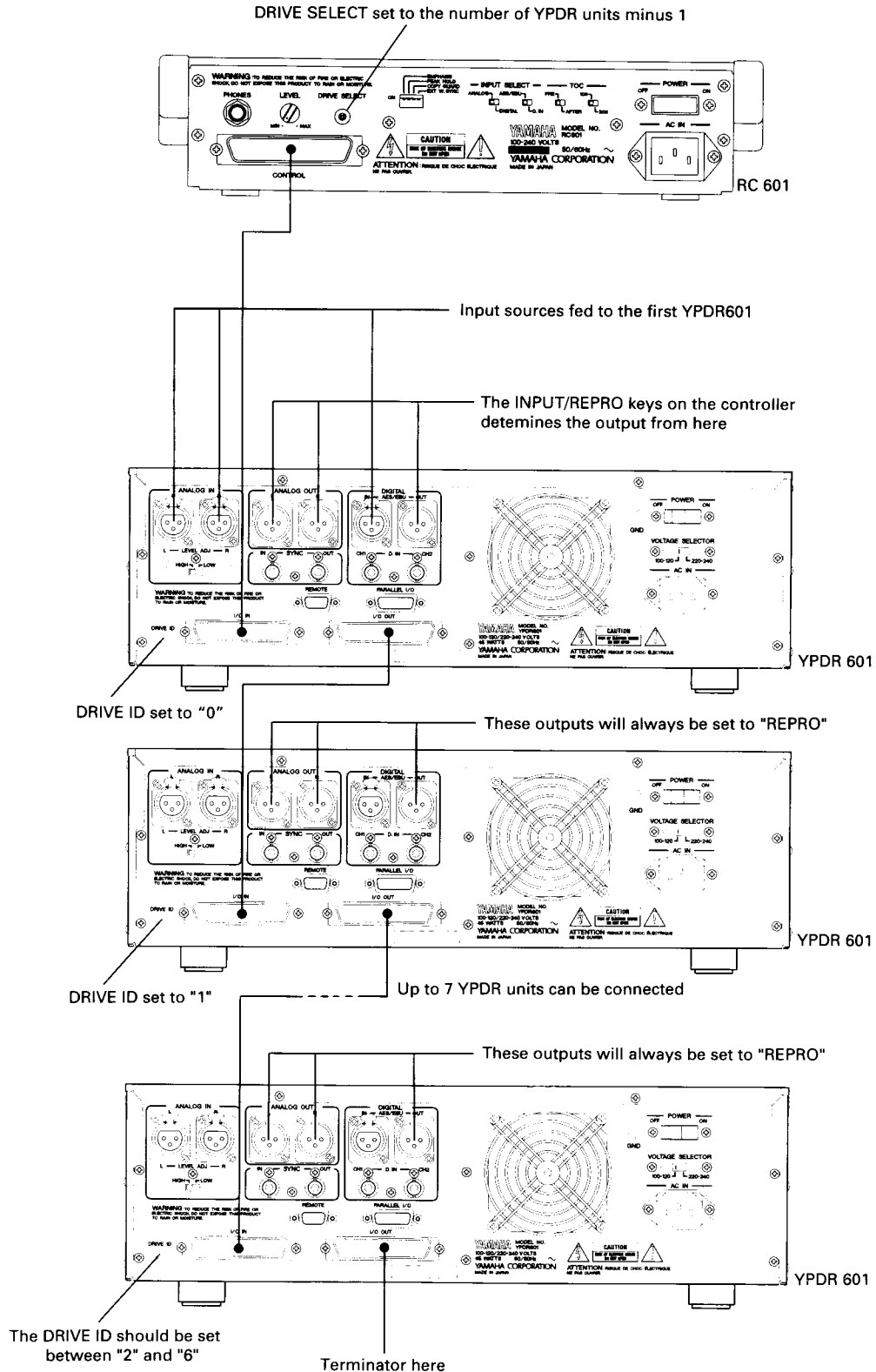

## 5 • Connection - Multi-recorder connection

---

The DRIVE SELECT switch on the rear of the controller should be set to the number of recorder units connected, minus one. In the illustrated example, three units are connected, so this switch should be set to "2".

The DRIVE ID switches of the recorder units should be set in sequence. The first unit should have an ID of "0", the next of "1", etc.

Units should be linked with the I/O OUT of one unit feeding the I/O IN of the next. The first unit in the chain is linked to the controller (CONTROL to I/O IN). The last unit in the chain should have the supplied terminator fitted to the I/O OUT connector.

Audio sources should be connected to the first recorder (ID="0") in the chain, as with the single-recorder setup (see "Single-recorder connection" on page 17 above).

It is necessary to make word clock connections if SDIF-II digital inputs are being used. There is no need to daisy-chain word clock connections, as they are carried through the 50-pin I/O buss from unit "0" (the first) down the chain to the last. The W.CLK IN DIP switch on the controller should be set accordingly.

REPRO monitoring can be carried out from all recorder units in the chain, but only the first recorder unit in the chain can be used for INPUT monitoring. Make monitoring connections accordingly.



## 6 • Operation

There are several basic methods of using the YPDR described here. Many of the basic operations are common to all methods.

### 6.1 Playback of previously-recorded CDs

The YPDR may be used as a CD player to play back discs recorded on the YPDR.

Switch on the power to the main unit, and then switch on the controller.

The LED display on the controller will show "-- -- -- --".

Press the OPEN/CLOSE key on the front of the main unit. The disc tray will open.

Place the disc, label upward, in the tray, and press the OPEN/CLOSE key to close the tray. The "DISC" indicator on the main unit will flash as the disc mechanism initializes.

When the disc initialization is complete, the "DISC" indicator will light steadily, and the display on the controller will read: "XX01Cd ", where "XX" corresponds to the total number of tracks on this disc. This display will be shown if the disc is (i) either a commercial CD, or (ii) a disc which has been recorded on the YPDR using the TOC AFTER mode. If the TOC PRE mode has been used to record the disc on the YPDR, the display will be different, as shown below:

#### 6.1.1 Disc type displays

Display	Meaning
00 00 bd	A blank disc which has no data (TOC or audio) recorded on it
XX 00 Ad	TOC AFTER mode, recording started, but not yet complete (ie TOC has yet to be written)
00 00 Ad 10	TOC PRE mode, 10 second track length, TOC recorded, but audio data unrecorded
00 00 Ad 30	TOC PRE mode, 30 second track length, TOC recorded, but audio data unrecorded
XX 00 Ad 10	TOC PRE mode, 10 second track length, recording not completed (not all tracks have been recorded)
XX 00 Ad 30	TOC PRE mode, 30 second track length, recording not completed (not all tracks have been recorded)
XX 01 Cd	Completed disc (either PRE or AFTER) or commercial CD

In the table above, "xx" always represents the number of tracks on the disc.

When the disc initialization is complete, the STOP key on the controller will light, and the "DISC" indicator on the main unit will stop flashing and will light steadily.

## 6 • Operation - Recording fixed tracks (TOC PRE mode)

---

Use the PLAY key to start replaying the disc. The PAUSE key, as well as the STOP key, can be used to halt playback.

### 6.1.2 Track and index location

When the YPDR is in PLAY mode, the TRACK and INDEX keys can be used to locate the start of playback by track, or by index. Repeated presses of these keys will continue to take the playback position forward or backward one track or index at a time, until the start or end of the disc is reached.

If the YPDR is in STOP mode while the TRACK keys are used, pressing PLAY will start playback from the selected track and index, as shown on the controller display. The INDEX keys cannot be used from STOP mode.

If the YPDR is in PLAY mode while these keys are used, playback will resume from the selected track/index when the keys are released.

### 6.1.3 Search mode

When the YPDR is in PAUSE mode, the SEARCH keys can be used to "scroll" through the disc. A single press of either of these keys will take the playback position forward or backward by one revolution of the disc.

A "cue" or "review" sound will be output when either of these keys is pressed and held down.

Pressing PLAY after searching in PAUSE mode will start playback from the point located by the search operation.

If the YPDR is in PLAY mode when these keys are used, releasing the SEARCH keys will resume playback from the point located by the search operation.

## 6.2 Recording fixed tracks (TOC PRE mode)

As described earlier, the YPDR is capable of recording audio data in fixed-length tracks after the TOC has been written. This enables a partially recorded disc to be produced, which may be played on standard CD players. Further recording may subsequently be carried out on that disc.

The length of a track can be set to either 10 seconds or 30 seconds. This time includes the 2 seconds of start time as described in "Track start" on page 23. However, program elements of a length greater than these times can be successfully recorded, as they will "spill over" onto the following track or tracks.

**NOTE** that you should not record material in the first two seconds of the first track. A CD player will not be able to play this material.

Since the CD standard allows for only up to 99 tracks on a single disc, the total running time of a TOC PRE disc is reduced from the CD standard maximum time. The running times are:

TOC track time	Total running time
10 seconds	16'30" (10 sec x 99)
30 seconds	49'30" (30 sec x 99)

Program elements which do not correspond directly to a multiple of the fixed track lengths can also be recorded. Using the AUTO PAUSE key, a period of silence is recorded from the end of the program material to the end of the current track.

### 6.2.1 Recording the TOC

Set the TOC PRE/AFTER switch on the rear panel of the controller to "PRE", and the 10/30 switch beside it to either "10S" or "30S" (the track length in seconds).

Load the disc into the main unit, as described in "Playback of previously-recorded CDs" on page 21.

When the DISC indicator on the main unit has stopped flashing, and the STOP key on the controller has lit, press the STDBY (standby) key, which will start flashing. When the laser writing circuit is ready to record data, the STDBY key will light steadily.

The display will show "0000 10" or "0000 30" (depending on the track length selected).

Press the TOC and REC keys together. This will start the TOC writing process. The REC MUTE, TOC, REC and PLAY keys will all light, and the RECORD indicator on the main unit will light.

The controller display will show the track and index numbers as they are written. The TOC writing process will take about two minutes.

Once the TOC has been written, the disc is "initialized" for TOC PRE recording, with a fixed track length of either 10 seconds or 30 seconds. After the TOC has been written, the recording mode of the disc cannot be changed.

### 6.2.2 Track start

When a TOC has been written, and the STDBY key is pressed, the display will show "0100 -02". If a number of tracks have already been written on the disc, the first 2-digit number on the display will indicate the first track available for writing. The "-02" corresponds to two seconds of source machine "preroll", and is explained below.

The structure of the start of a track is shown below:

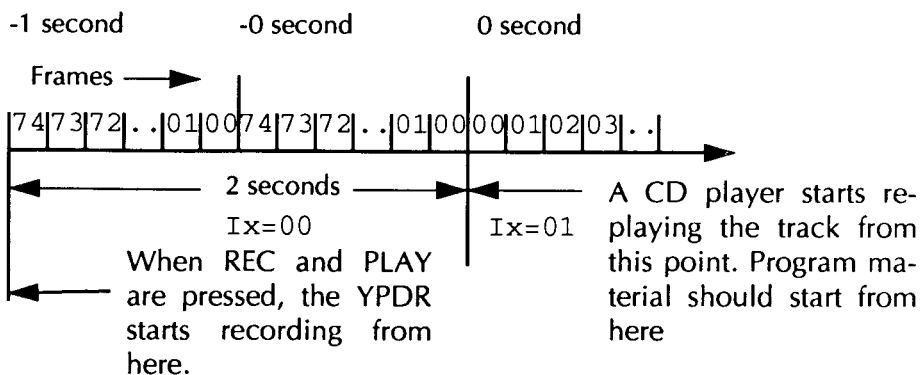

It should be noted that it is possible to start recording from the "-1" position (as indicated by the "0100-01" display on the controller and the RECORD indicator on the main unit front panel). However, subsequent replay from a track start will begin at the "0 second" point, ignoring recorded material from "-02" to "00".

### 6.2.3 Rehearsing an audio recording

When the REC and PLAY keys are pressed together, the YPDR will start recording, and a "PLAY" message will be transmitted from the 9-pin REMOTE connec-

## 6 • Operation - Recording fixed tracks (TOC PRE mode)

---

tor ("PLAY1" and "PLAY2" messages will also be sent from the PARALLEL I/O connector. See the "Parallel I/O timing chart" on page 35 for details). This allows the simultaneous start of source machines capable of receiving these commands.

A rehearsal mode is provided to check that the source machine is correctly located prior to actual recording.

With the STDBY key lit, press the REHEARSAL key, which will light the rehearsal indicator

When the REHEARSAL indicator is lit and REC and PLAY are pressed together, a "PLAY" command is transmitted from the REMOTE connector (the parallel connector will also transmit "PLAY1" and "PLAY2" messages), the PLAY key lights, and the REC key flashes. The controller display will count from "-02" to "-01" to "-00" to "00" and then start counting upwards.

This "pseudo-record" mode will be maintained for 10 seconds. No transport keys except the STOP key will have any function at this time.

The start of the program material should follow closely after the controller display reaches "XX 01 0000".

After 10 seconds, the REC and PLAY lights go out, and a "STOP" command is sent from the REMOTE and the PARALLEL I/O connectors.

Re-locate the source to the start (adjusting the locate point if necessary). Further rehearsals can be carried out as long as the REHEARSAL indicator and the STDBY key are both lit.

### Levels

Make sure that the loudest part of the program material lights the "0" segment of the controller's meters, but does not light the "OVER" segment. This does not have to be done in rehearsal mode, but should be done before a recording on disc is made, to avoid digital clipping.

To turn off the rehearsal mode, press the REHEARSAL key so that the indicator goes out.

### 6.2.4 Audio recording

**NOTE:** Recording can only take place when the STDBY key is lit steadily (not flashing).

Make sure the source is located to the required position.

Press the REC and PLAY keys together. Both will light steadily.

If the source is being controlled by the REMOTE or PARALLEL I/O signals, the "PLAY" command (REMOTE) will be sent at the -01 second, 74 frames point. "PLAY1" and "PLAY2" messages will be sent from the PARALLEL I/O connector. See the "Parallel I/O timing chart" on page 35 for details.

If the source is being manually controlled, start the source as soon as the display on the controller reaches "XX 01 0000".

With the LINE indicator illuminated, monitoring can be done from the source (INPUT) or off-disc (REPRO) by selecting the appropriate option.

As the recording progresses, the rightmost indicators (time indicators) of the display will advance. If the program is longer than the pre-defined track length, the track number will be incremented automatically. It is not possible to use the TrINC (track increment) key in TOC PRE mode, but the IxINC (index incre-

ment) key can be used to write index markers after the index number in the display has changed to "01".

### **REC MUTE**

The REC MUTE key will mute the signal from the source while recording is in progress. The REC MUTE key is latching (press once for on, again for off). The input can be monitored during muting by setting the INPUT/REPRO key to INPUT.

### **STOP/PAUSE**

If the STOP or PAUSE key is pressed more than one second before the end of the current track, the record mute function is enabled, the display will flash, and the YPDR will record silence until the end of the current track. If STOP has been pressed, the YPDR will go into stop mode (STOP will be lit). If PAUSE has been pressed, the YPDR will go into record pause mode (REC and PAUSE will be lit). Pressing the STOP key or the PAUSE key will also send a remote "STOP" message.

**NOTE:** PAUSE and STOP operations as described above will not work while recording track 99. However, a remote "STOP" message will be transmitted.

To restart recording from PAUSE, press PLAY alone (the REC key will remain lit). To restart recording from STOP, enter standby mode, and press PLAY and REC together.

### **AUTO PAUSE**

When the AUTO PAUSE key is on, recording will automatically pause at the end of each track (10 or 30 seconds), and the YPDR will go into PAUSE mode. The AUTO PAUSE key can be turned on or off in standby, record, or record pause mode. The STOP and REC MUTE keys can also be used when the AUTO PAUSE key is lit, as described above.

**NOTE:** A disc recorded in the TOC PRE mode can be played on any CD player, even if only a few tracks out of the 99 available tracks have been recorded. However, some players may experience difficulties when set to repeat the last track. This can be overcome by recording a blank track immediately following the last recorded track.

### **6.2.5 Lead-out**

To complete a CD capable of being played on an ordinary CD player, a "lead-out" should be recorded. This is done automatically after the last track (track 99 in TOC PRE mode).

After the last program material has been recorded, start recording from standby mode (REC and PLAY simultaneously). Recording will continue up to the 99th track, and then the lead-out will be recorded.

While this is taking place, any source material input will be recorded. Make sure REC MUTE is on to avoid recording unwanted material.

## **6.3 Recording variable tracks (TOC AFTER mode)**

Recording in the TOC AFTER mode allows a variable number of tracks to be recorded, of different lengths. However, a disc produced in this way cannot be read on a commercial CD player until the final TOC has been written (though it can be replayed on the YPDR).

## 6 • Operation - Recording variable tracks (TOC AFTER mode)

---

When a blank disc is inserted, the display will show "0000bd". If a disc already containing audio data but no TOC data is inserted, the display will show "xx00Ad", where "xx" is equal to the number of tracks already recorded.

Make sure the TOC PRE/AFTER switch on the rear panel is set to "AFTER". The position of the 30S/10S switch has no effect.

### 6.3.1 Track start

When a disc is first inserted and the STDBY key is pressed, the display will show "0100-02". If a number of tracks have already been written on the disc, the first 2-digit number on the display should indicate the first track available for writing.

The structure of the start of a track is the same as in the TOC PRE as explained in "Track start" on page 23.

It should be noted that it is possible to start recording from the "-1" position (as indicated by the "0100-01" display and the RECORD indicator on the main unit being lit). However, subsequent replay from a track start will position the replay point at the "00" point, ignoring any material recorded from "-02" to "00".

#### Minimum track lengths

When recording in TOC AFTER mode, the YPDR sets minimum track lengths. For tracks 1 through 50, the minimum track length is 20 seconds. For tracks 51 through 99, the minimum track length is 40 seconds. This track length includes the two seconds before index 01 as described in "Track start" on page 23.

Recording cannot be performed on a disc which has less than the minimum track time remaining for recording.

### 6.3.2 Rehearsal

The REHEARSAL key functions in the TOC AFTER mode in the same way as in the TOC PRE mode, as explained in "Rehearsing an audio recording" on page 23. The YPDR provides 10 seconds of rehearsal time to check the source cueing at the start of the track.

"PLAY" and "STOP" commands are transmitted from the REMOTE and PARALLEL I/O connectors in the same way as the TOC PRE mode.

### 6.3.3 Audio recording

Recording will start from the position immediately following the last recorded data (if any). Press the STDBY key. The number of the track to be recorded will be shown on the display.

Pushing REC and PLAY together will start the recording process.

As with TOC PRE recording, pressing the IxINC key will add an index marker at the point where the key is pressed.

It is also possible to use the TrINC key to enter track markers "on-the-fly" while recording audio material. When the TrINC key is pressed, the track number on the display will increment, and the time will be -01 second and 74 frames. The frame value will not be displayed. This will advance to "00", in the same way as when a track starts.

This means that when a CD player replays the disc, location to a track will position the playback point to "00" (two seconds after the TrINC key was pressed).

Track increment messages can also be received through the PARALLEL I/O connector.

### **REC MUTE**

The REC MUTE key can be used to mute the source signal. However, the source signal can still be monitored using the LINE and INPUT/REPRO keys. The REC MUTE key is latching (push once to turn on, push again to turn it off).

### **PAUSE**

The PAUSE key will temporarily halt recording, and will send a "STOP" message from the REMOTE and PARALLEL I/O connectors. If the PAUSE key is pressed before the track has reached the minimum period, REC MUTE will be engaged, the PAUSE key will flash, and the YPDR will continue recording silence to the end of the minimum period. To resume recording, press PLAY.

### **STOP**

The STOP key will halt recording, and will send a "STOP" message from the REMOTE and PARALLEL I/O connectors. If the STOP key is pressed before the track has reached the minimum period, REC MUTE will be engaged, the STOP key will flash, and the YPDR will continue recording silence to the end of the minimum period. To resume recording, enter standby mode, and press PLAY and REC together. The track number will automatically be incremented.

### **6.3.4 Recording the TOC**

When all tracks have been recorded, the TOC may be written. This enables the disc to be played on a commercial CD player.

Writing the TOC is a once-only process -once a TOC has been written, further audio tracks cannot be recorded.

Press STDBY to put the YPDR in standby mode. Press the TOC and REC keys together to record the TOC. Recording the TOC takes about 4 minutes. A lead-in and lead-out will be added, and 2 seconds will be added to the running time of the final track.

When the TOC recording process is complete, "XX01Cd--" will be displayed, indicating that the TOC has been written and the disc can be played on a commercial CD player.

## **6.4 Multi-recorder recording**

It is possible to record on up to seven recorder units simultaneously, controlling all recorders from the same controller unit. This enables production of a number of identical discs.

Select one recorder unit to be the "main unit". This should have the DRIVE ID switch on the rear panel set to "0". All other units should have their IDs set to count upward from this unit.

Connections should be made as described in "Multi-recorder connection" on page 19. The last unit in the "daisy-chain" should be terminated using the terminator on the I/O OUT connector.

The DRIVE SELECT switch on the rear panel of the controller should be set to the number of recorder units in the system, minus 1 (eg, if three recorder units are in the chain, this switch should be set to "2").

If a number of units are connected together as described above, but recording is to be carried out on only one unit, then all units must be switched on. Do not put discs in the machines that you do not want to use for recording.

In PLAY or standby mode, the disc trays of all the recorder units must be closed.

## 6 • Operation - Duplication

Recording may be carried out only in the TOC AFTER mode. Operation is the same as for single-unit operation.

If recording is to be carried out in multi-recorder mode, then the discs in all the recorder units should contain identical information. Even if not all recorders are being used to record, all disc trays must be closed.

Monitoring of the INPUT can be done only from the first recorder in the chain.

**NOTE** that though the recorders are synchronized through the controller, on playback, the start may be de-synchronized by up to about 40 frames (approximately 0.5 seconds). This is due to the PAUSE⇒PLAY operation. If the contents of several identical discs are monitored simultaneously through several channels of a mixing console, for example, the playback will not be synchronized. However, the contents of the discs are identical.

Multi-recorder playing can be carried out only if the same type of disc (length) should be inserted in all the recorder units being used.

### 6.5 Duplication

It is possible to duplicate a whole disc onto up to six other discs simultaneously. The connections and drive ID settings for N recorders are shown below:

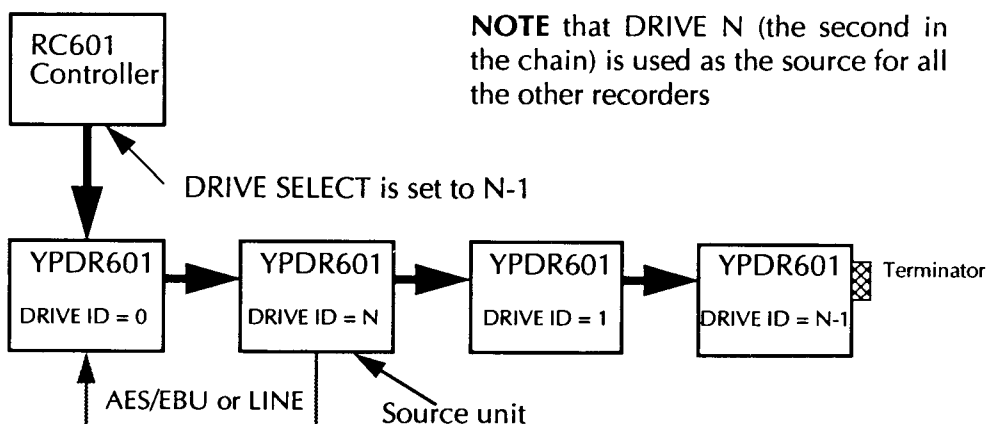

Duplication of commercial CDs is not possible.

The DIGITAL AES/EBU (OUT) or the ANALOG OUT of the unit whose DRIVE ID is set to "N" should be connected to the DIGITAL AES/EBU (IN) or ANALOG IN of unit "0", depending on whether digital or analog duplication is to be performed. SDIF-II duplication cannot be performed. The appropriate switches should be set on the rear panel of the controller (INPUT SELECT switches).

If analog disc duplication is to be performed, the EMPHASIS flag cannot be duplicated.

The source disc should be placed in the tray of unit "N", and blank discs should be placed in the trays of units "0" through "N-1". If not all the available units are being used for duplication, blank discs should be placed in the trays of as many units as are being used for duplication, starting at "0" and working upwards.

The DISC indicators on all recorder units except recorder N (the source recorder) will light. The ERROR indicator on recorder N will light. This does not indicate an error. When the ERROR light on recorder N comes on, press the STDBY key on the controller. The ERROR indicator on unit N will go out, and the DISC



indicator will come on. Unit N will enter PLAY/PAUSE mode, and the other units will go into REC/PAUSE mode.

Press PLAY and REC together when the STDBY key is lit steadily. REC and PLAY will light, and will go off when the duplication process is complete.

The STOP, PAUSE, REC or TOC keys will interrupt the duplication process. Once stopped, the process cannot be restarted.

It is therefore important that no keys are pressed while the duplication is in progress.

Once the duplication process has been completed, the controller display will show: "XX XX cd".

## 7 • Errors

It is possible that an internal error will occur while the YPDR is being operated. This will cause the ERROR indicator on the main display to light, and also light the ALARM indicator on the controller front panel. Occasionally the ALARM indicator on the controller will light, but the ERROR indicator on the main unit will not light. This does not indicate an error condition.

To determine the cause of the error, press the TrINC and DISPLAY keys simultaneously when the ERROR indicator is lit. The display will show a code, corresponding to one of the errors shown below:

Code	Error
01	PLL lock (word clock sync) has been lost. Check the digital input connections and word clock source.
02	Wrong kind of disc. A PRE/AFTER setting failure may have occurred.
03	I/O transmission failure. Check the 50-way cable connection.
04	Head mechanism locked. Check the head lock switch position.
05	Focus lock error.
06	Speed (spindle) lock error.
07	Laser power optimum value detection error.
08	Positioning error.
09	Attempt to record digital audio input signal with a sampling frequency which is not 44.1kHz, or data which is not audio data.
0A	Initialization tracking error.

If an error occurs, try the following procedure to correct the error. If the source of the error is obvious (e.g. error 01, 02, 03, 04 or 09), correct the situation. Otherwise, open the disc tray and remove the disc. Close the disc tray. Switch off the controller, and then switch off the main unit. Wait a few seconds, and switch on the main unit, followed by the controller. Replace the disc and try again. If the error occurs again, try this procedure again, using another disc. If problems still occur, consult your dealer.

## 8 • Technical specifications

### 8.1 Controller (RC601)

Operating temperature	0°C to 40°C (32°F to 104°F)
Relative humidity	30% to 80% (non-condensing)
Operating voltage	100VAC-240VAC (50/60Hz)
Power consumption	Max 13W
Dimensions (WxHxD)	310 x 75 x 221 (mm) (12.2 x 3 x 8.7 (in))
Weight	2.4kg (5.3lbs)

## 8.2 Recorder Unit (YPDR601)

Recording format	CD-DA
Recording medium	Yamaha specified disc
Maximum recording time	74 minutes (subject to medium)
Analog connections	
ANALOG IN	2 x XLR-3-31 type (balanced)
	HIGH: nominal +4dBm, maximum before clipping +24dBm/10k $\Omega$
	LOW: nominal -9dBm, maximum before clipping +11dBm/50k $\Omega$
Input level trimmers	Allow $\pm 3$ dB adjustment
ANALOG OUT	2 x XLR-3-32 type (balanced), nominal -2dBm, maximum before clipping +18dBm, 150 $\Omega$ impedance
Digital connections	
AES/EBU IN	XLR-3-31 type (balanced), sampling frequency 44.1kHz $\pm 500$ ppm, RS-422A level, 110 $\Omega$
D. IN	2 x BNC, SDIF-II, TTL level, 75 $\Omega$
AES/EBU OUT	XLR-3-32 type (balanced), RS-422A level
Control connections	
SYNC IN	BNC, TTL level, 75, fs=44.1kHz $\pm 500$ ppm
SYNC OUT	BNC, TTL level
REMOTE	D-sub 9-pin serial remote connector
PARALLEL I/O	D-sub 15-pin parallel remote connector (GPI), open collector
I/O IN	50-pin 57 connector
I/O OUT	50-pin 57 connector
Operating temperature	15°C to 35°C (59°F to 95°F)
Relative humidity	30% to 80% (non-condensing)
Operating voltage	100-120VAC/220VAC-240VAC (50/60Hz)
Power consumption	Max 45W
Dimensions (WxHxD)	with feet, but without rack ears - 435 x 147 x 400 (mm) (17 x 5.8 x 15.75 (in)). When feet are removed, and rack ears fitted, the YPDR601 can be fitted into a 19" equipment rack, taking 3U of space
Weight	14kg (30.9lbs)

### 8.3 50-pin I/O connector pinout

Signal name	Pin number		Signal name
SHIELD GROUND	1	26	GROUND
+DB(0)	2	27	-DB(0)
+DB(1)	3	28	-DB(1)
+DB(2)	4	29	-DB(2)
+DB(3)	5	30	-DB(3)
+DB(4)	6	31	-DB(4)
+DB(5)	7	32	-DB(5)
+DB(6)	8	33	-DB(6)
+DB(7)	9	34	-DB(7)
+DB(P)	10	35	-DB(P)
DIFFSENS	11	36	GROUND
+AES	12	37	-AES
TERMPWR	13	38	TERMPWR
+DATA	14	39	-DATA
+ATN	15	40	-ATN
+SFS	16	41	-SFS
+BSY	17	42	-BSY
+ACK	18	43	-ACK
+RST	19	44	-RST
+MSG	20	45	-MSG
+SEL	21	46	-SEL
+C/D	22	47	-C/D
+REQ	23	48	-REQ
+I/O	24	49	-I/O
GROUND	25	50	GROUND

### 8.4 Serial REMOTE (D-sub 9-pin)

The connector can transmit PLAY and STOP commands to the source tape recorder (e.g. the Yamaha DMR8 or DRU8) using industry-standard serial protocol.

### 8.5 PARALLEL I/O (D-sub 15-pin)

Pin	Signal name	I/O
1	PLAY1	O
2	GND	-
3	PLAY2	O
4	GND	-
5	STOP	O
6	GND	-
7	REC STOP	I
8	GND	-
9	REC PLAY	I
10	GND	-
11	REC PAUSE	I
12	GND	-
13	TrINC	I
14	GND	-
15	GND	-

An IxINC (I) signal is equivalent to a REC PLAY and a TrINC signal being transmitted simultaneously (both REC PLAY and TrINC go low at the same time).

8.5.1 Parallel I/O timing chart

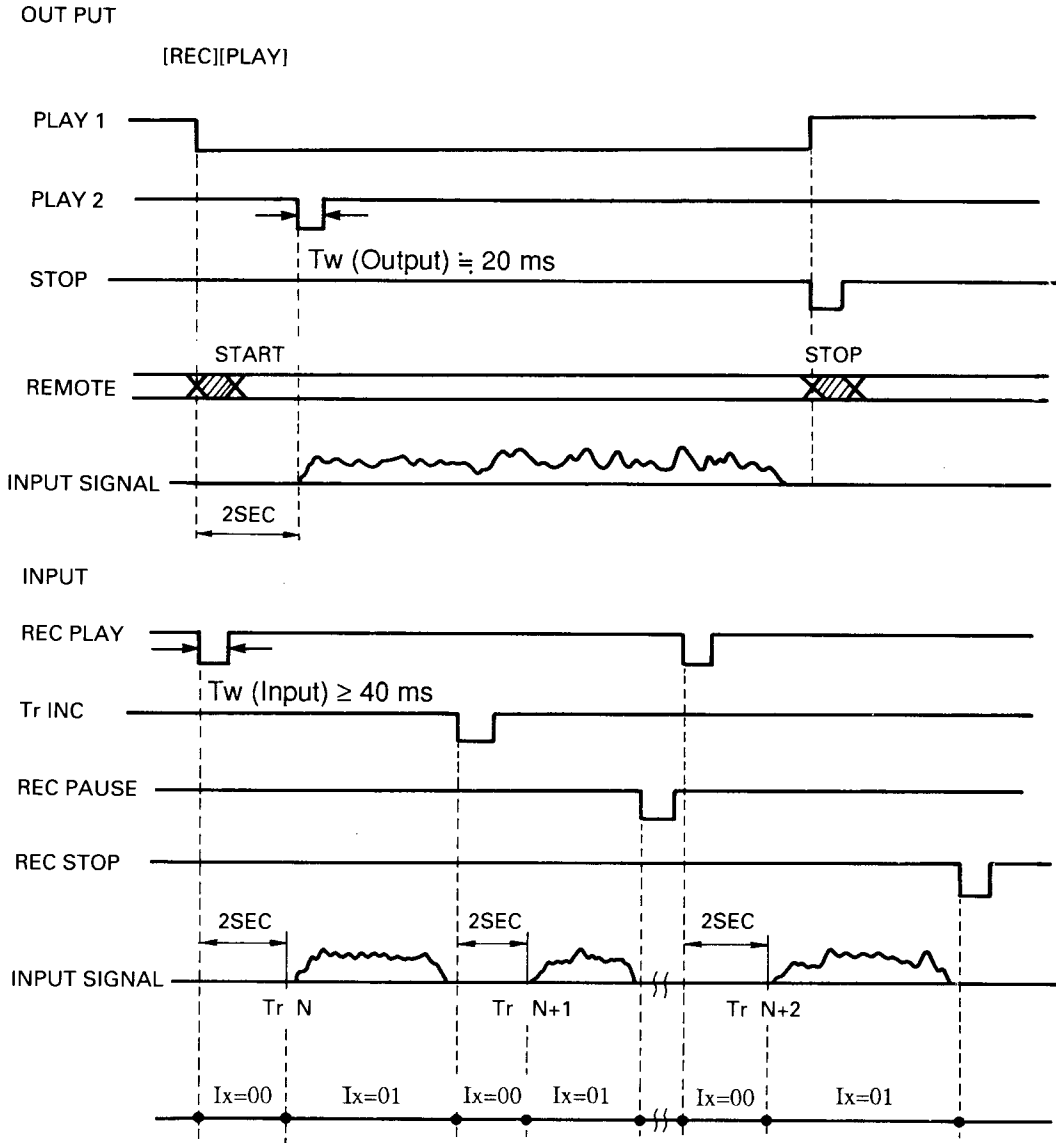

<b>A</b>	
AC power	10
AES/EBU	10, 18, 28
ALARM indicator	12, 30
ANALOG IN	9
Analog input level line-up	18
ANALOG OUT	10, 28
Applications	4
A-TIME	13
Audio connections	17
AUTO PAUSE	14, 22, 25
<b>B</b>	
Broadcasting	4
<b>C</b>	
C1 error	8
C1 indicator	8
Care of discs	6
Condensation	6
Connection	17
COPY GUARD	12, 15
COPY PROHIBIT indicator	12
Copyright	7
<b>D</b>	
D.IN	10
DIGITAL IN indicator	12
DISC indicator	8
Disc tray	8
Disc type displays	21
Display	13
DRIVE ID	10, 18, 20
DRIVE SELECT	15, 17, 20
Duplication	28
<b>E</b>	
EMPHASIS	15
EMPHASIS indicator	12
ERROR indicator	9
<b>F</b>	
Fan	10
Features	3
50-pin I/O connector	11
Pinout	33
Fixed track lengths	3
Focus lock error	30
<b>H</b>	
Head lock	5, 11, 30
Headphone monitoring	17
Headphones	15
HIGH/LOW switch	9
<b>I</b>	
I/O transmission failure	30
INDEX	22
Initialization tracking error	30
INPUT SELECT switches	16
INPUT/REPRO key	18
IxINC	14
<b>L</b>	
Lead-out	25
LED displays	13
LEVEL ADJ	9
<b>M</b>	
Main unit	
Front panel	8
Rear panel	9
Maximum number of tracks	3
Maximum recording time	3
Meters	13, 15, 24
Monitoring	13, 20, 24
Multi-recorder connection	19
Multi-recorder recording	27
<b>N</b>	
9-pin connector	33, 11
Nominal level	9
Number of tracks	3
<b>O</b>	
OPEN/CLOSE key	8
<b>P</b>	
Packing list	5
PARALLEL I/O	34
Parallel I/O timing	35
PEAK HOLD	15
Playback	21
PLL lock	30
Positioning error	30
Post-production	4
POWER indicator	8
POWER switch	16
P-TIME	13
<b>R</b>	
Rack mounting	5
RC601	10
REC MUTE	14, 25, 27
Recording the TOC	27
Rehearsal	14, 23, 26
REMAIN	13
REMOTE connector	11
<b>S</b>	
SDIF-II	10, 15, 18, 20
SEARCH	14
Search	22
Single-recorder connection	17
Specifications	
RC601	31
YPDR601	32
Speed (spindle) lock	30



STDBY 23  
SYNC 10

**T**

Terminator 11, 18  
TOC AFTER 3, 25  
TOC indicator 13  
TOC PRE 3, 14, 16, 22  
TRACK 22  
Track and index location 22  
TRACK display 13  
Track start structure 23  
Transport controls 14  
Trimmer controls 18  
TriNC 9, 14, 24, 26

**V**

Variable track lengths 3  
Voltage selector 5, 10

**W**

Warm-up 6  
Word clock 15, 18, 20  
Wrong kind of disc 30

**Y**

YPDR601 8

# YAMAHA