

YAMAHA Electone®

**EL-7
EL-15**

OWNER'S MANUAL

SPECIAL MESSAGE SECTION

PRODUCT SAFETY MARKINGS: Yamaha electronic products may have either labels similar to the graphics shown below or molded/stamped facsimiles of these graphics on the enclosure. The explanation of these graphics appears on this page. Please observe all cautions indicated on this page and those indicated in the safety instruction section.

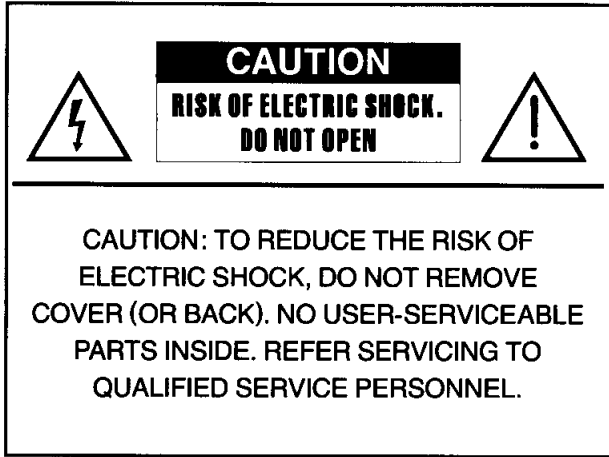

See bottom of keyboard enclosure for graphic symbol markings.



The exclamation point within the equilateral triangle is intended to alert the user to the presence of important operating and maintenance (servicing) instructions in the literature accompanying the product.

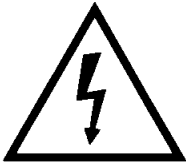

The lightning flash with arrowhead symbol within the equilateral triangle is intended to alert the user to the presence of uninsulated "dangerous voltage" within the product's enclosure that may be of sufficient magnitude to constitute a risk of electrical shock.

IMPORTANT NOTICE: All Yamaha electronic products are tested and approved by an independent safety testing laboratory in order that you may be sure that when it is properly installed and used in its normal and customary manner, all foreseeable risks have been eliminated. **DO NOT** modify this unit or commission others to do so unless specifically authorized by Yamaha. Product performance and/or safety standards may be diminished. Claims filed under the expressed warranty may be denied if the unit is/has been modified. Implied warranties may also be affected.

SPECIFICATIONS SUBJECT TO CHANGE: The information contained in this manual is believed to be correct at the time of printing. However, Yamaha reserves the right to change or modify any of the specifications without notice or obligation to update existing units.

ENVIRONMENTAL ISSUES: Yamaha strives to produce products that are both user safe and environmentally friendly. We sincerely believe that our products and the production methods used to produce them, meet these goals. In keeping with both the letter and the spirit of the law, we want you to be aware of the following:

Battery Notice: This product **MAY** contain a small non-rechargeable battery which (if applicable) is soldered in place. The average life span of this type of battery is approximately five years. When replacement becomes necessary, contact a qualified service representative to perform the replacement.

Warning: Do not attempt to recharge, disassemble, or incinerate this type of battery. Keep all batteries away from children. Dispose of used batteries promptly and as regulated by applicable laws. Note: In some areas, the servicer is required by law to return the defective parts. However, you do have the option of having the servicer dispose of these parts for you.

Disposal Notice: Should this product become damaged beyond repair, or for some reason its useful life is considered to be at an end, please observe all local, state, and federal regulations that relate to the disposal of products that contain lead, batteries, plastics, etc.

NOTICE: Service charges incurred due to lack of knowledge relating to how a function or effect works (when the unit is operating as designed) are not covered by the manufacturer's warranty, and are therefore the owners responsibility. Please study this manual carefully and consult your dealer before requesting service.

NAME PLATE LOCATION: The graphic below indicates the location of the name plate. The model number, serial number, power requirements, etc., are located on this plate. You should record the model number, serial number, and the date of purchase in the spaces provided below and retain this manual as a permanent record of your purchase.

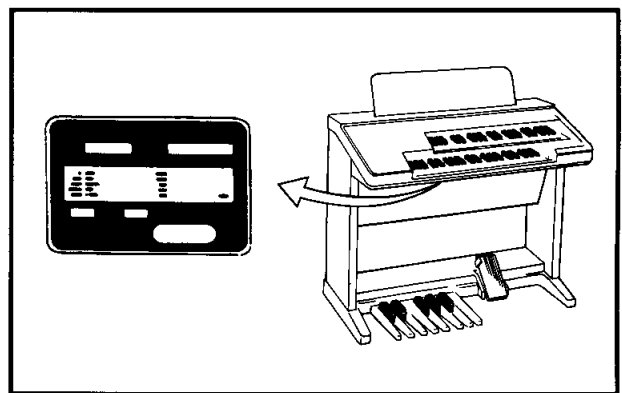

Model _____

Serial No. _____

Purchase Date _____

FCC INFORMATION (U.S.A.)

1. IMPORTANT NOTICE: DO NOT MODIFY THIS UNIT!
This product, when installed as indicated in the instructions contained in this manual, meets FCC requirements. Modifications not expressly approved by Yamaha may void your authority, granted by the FCC, to use the product.

2. IMPORTANT: When connecting this product to accessories and/or another product use only high quality shielded cables. Cable/s supplied with this product MUST be used. Follow all installation instructions. Failure to follow instructions could void your FCC authorization to use this product in the USA.

3. NOTE: This product has been tested and found to comply with the requirements listed in FCC Regulations, Part 15 for Class "B" digital devices. Compliance with these requirements provides a reasonable level of assurance that your use of this product in a residential environment will not result in harmful interference with other electronic devices. This equipment generates/uses radio frequencies and, if not installed and used according to the instructions found in the users manual, may cause interference harmful to the operation of other electronic devices. Compliance with FCC regulations does not guarantee that interference will not

occur in all installations. If this product is found to be the source of interference, which can be determined by turning the unit "OFF" and "ON", please try to eliminate the problem by using one of the following measures:

Relocate either this product or the device that is being affected by the interference.

Utilize power outlets that are on different branch (circuit breaker or fuse) circuits or install AC line filter/s.

In the case of radio or TV interference, relocate/reorient the antenna. If the antenna lead-in is 300 ohm ribbon lead, change the lead-in to co-axial type cable.

If these corrective measures do not produce satisfactory results, please contact the local retailer authorized to distribute this type of product. If you can not locate the appropriate retailer, please contact Yamaha Corporation of America, Electronic Service Division, 6600 Orangethorpe Ave, Buena Park, CA 90620.

The above statements apply ONLY to those products distributed by Yamaha Corporation of America or its subsidiaries.

CANADA

THIS DIGITAL APPARATUS DOES NOT EXCEED THE "CLASS B" LIMITS FOR RADIO NOISE EMISSIONS FROM DIGITAL APPARATUS SET OUT IN THE RADIO INTERFERENCE REGULATION OF THE CANADIAN DEPARTMENT OF COMMUNICATIONS.

This applies only to products distributed by Yamaha Canada Music Ltd.

LE PRESENT APPAREIL NUMERIQUE N'EMET PAS DE BRUITS RADIOELECTRIQUES DEPASSANT LES LIMITES APPLICABLES AUX APPAREILS NUMERIQUES DE LA "CLASSE B" PRESCRITES DANS LE REGLEMENT SUR LE BROUILLAGE RADIO ELECTRIQUE EDICTE PAR LE MINISTERE DES COMMUNICATIONS DU CANADA.

Ceci ne s'applique qu'aux produits distribués par Yamaha Canada Music Ltd.

CAUTION: TO PREVENT ELECTRIC SHOCK, MATCH WIDE BLADE OF PLUG TO WIDE SLOT, FULLY INSERT.

ATTENTION: POUR ÉVITER LES CHOCS ÉLECTRIQUES, INTRODUIRE LA LAME LA PLUS LARGE DE LA FICHE DANS LA BORNE CORRESPONDANTE DE LA PRISE ET POUSSER JUSQU'AU FOND.

Dette apparat overholder det gældende EF-Direktiv vedrørende radiostøj.

Cet appareil est conforme aux prescriptions de la directive communautaire 87/308/CEE.

Diese Geräte entsprechen der EG-Richtlinie 82/499/EWG und/oder 87/308/EWG.

This product complies with the radio frequency interference requirements of the Council Directive 82/499/EEC and/or 87/308/EEC.

Questo apparecchio è conforme al D.M.13 aprile 1989 (Direttiva CEE/87/308) sulla soppressione dei radiodisturbi.

Este producto está de acuerdo con los requisitos sobre interferencias de radio frecuencia fijados por el Consejo 87/308/CEE.

YAMAHA CORPORATION

IMPORTANT

THE WIRES IN MAINS LEAD ARE COLOURED IN ACCORDANCE WITH THE FOLLOWING CODE:

Blue: NEUTRAL
Brown: LIVE

As the colours of the wires in the mains lead of this apparatus may not correspond with the coloured markings identifying the terminals in your plug, proceed as follows: The wire which is coloured BLUE must be connected to the terminal which is marked with the letter N or coloured BLACK. The wire which is coloured BROWN must be connected to the terminal which is marked with the letter L or coloured RED.

Making sure that neither core is connected to the earth terminal of the three pin plug.

Wichtiger Hinweis für die Benutzung in der Bundesrepublik Deutschland.

Bescheinigung des Importeurs

Hiermit wird bescheinigt daß die Elektronische Orgel Typ: EL-7, EL-15 in Übereinstimmung mit den Bestimmungen der VERFÜGUNG 1046/84 (Amtsblattverfügung) funktentstört ist.

Der Deutschen Bundespost wurde die Berechtigung zur Überprüfung der Serie auf Einhaltung der Bestimmungen eingeräumt. Das Funkschutzzeichen ist beim VDE beantragt.

Yamaha Europa GmbH: (Name des Importeurs)

* Dies bezieht sich nur auf die von der YAMAHA EUROPE GmbH vertriebenen Produkte.

EL-7

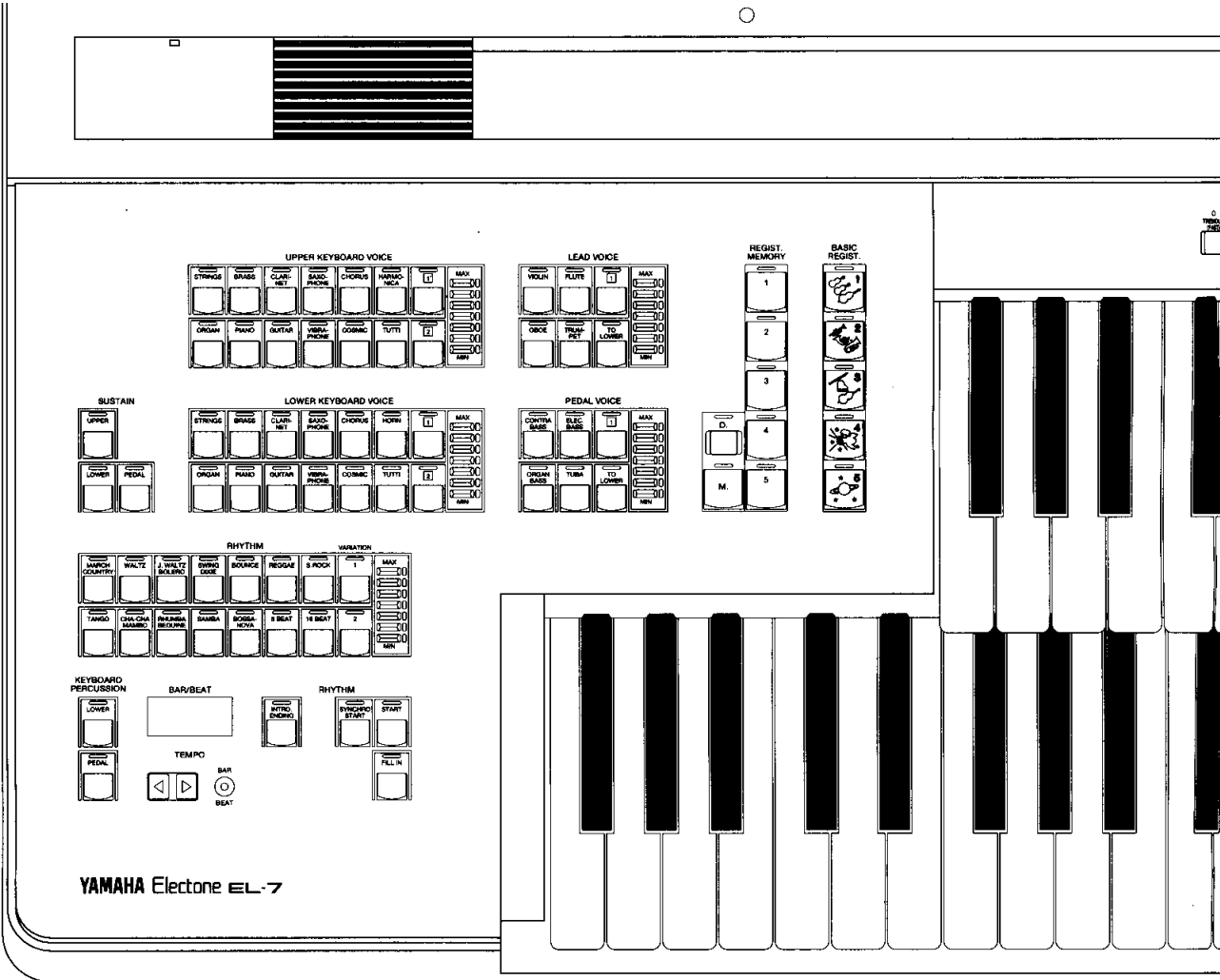

EL-15

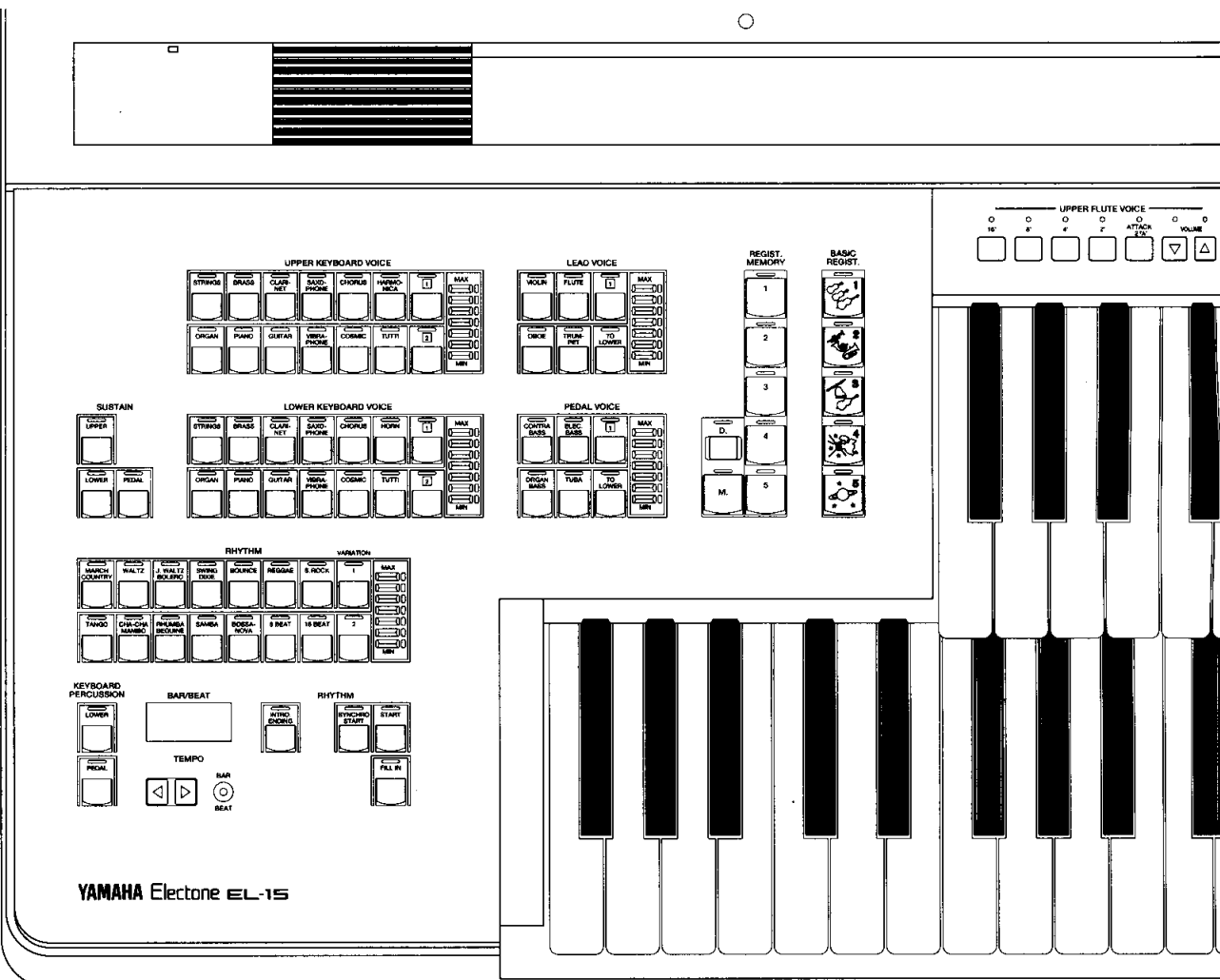

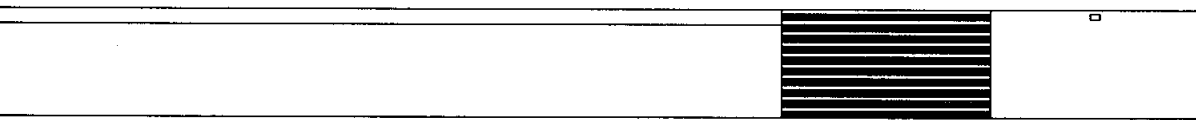

REGISTRATION MENU
 1 2 3 4 5 6 7 8 9 10 11 12 13 14 15 16 17 18 19 20

AUTO BASS CHORD
 SINGLE FINGER PROGRAM CUSTOM MEMORY

ACCOMPANIMENT
 M.O.C. TRANSPOSITION PITCH

MASTER VOLUME

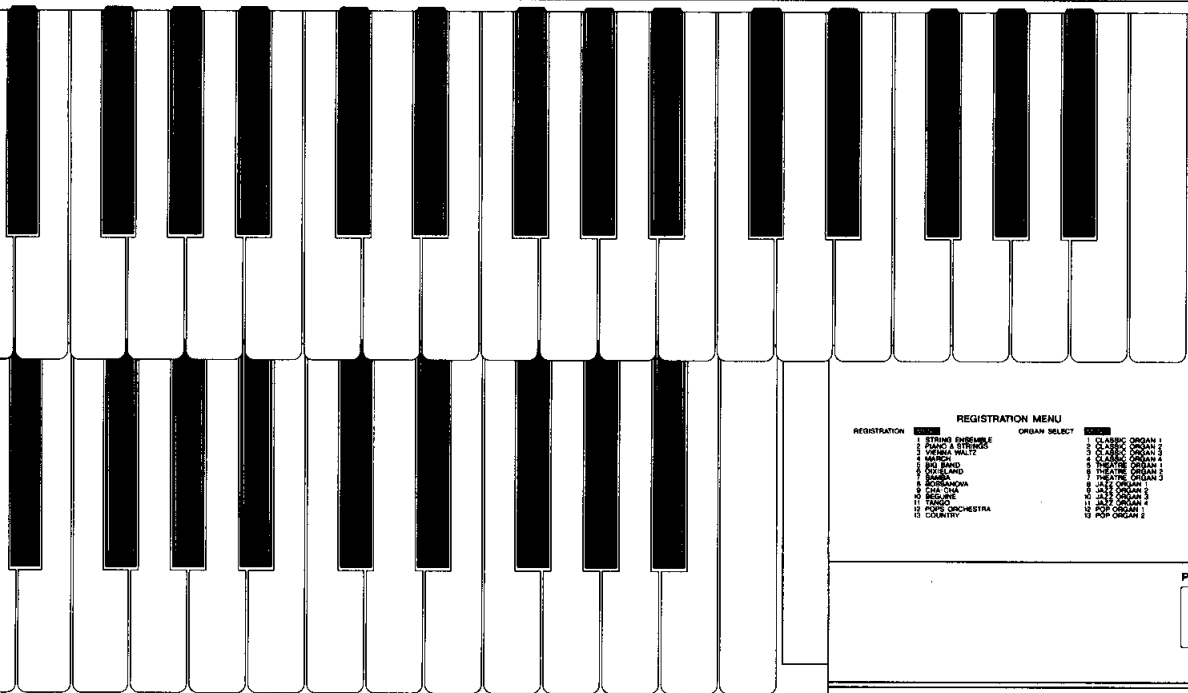

REGISTRATION MENU

REGISTRATION	ORGAN SELECT
1	STRONG ENSEMBLE
2	PIANO & STRINGS
3	PIANO WALTZ
4	PIANO
5	PIANO 2
6	PIANO 3
7	PIANO 4
8	PIANO 5
9	PIANO 6
10	PIANO 7
11	PIANO 8
12	PIANO 9
13	PIANO 10
14	PIANO 11
15	PIANO 12
16	PIANO 13
17	PIANO 14
18	PIANO 15
19	PIANO 16
20	PIANO 17

POWER

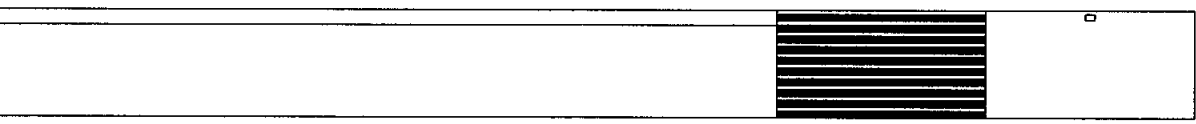

LOWER FLUTE VOICE
 F F F VOLUME

REGISTRATION MENU
 1 2 3 4 5 6 7 8 9 10 11 12 13 14 15 16 17 18 19 20

AUTO BASS CHORD
 SINGLE FINGER PROGRAM CUSTOM MEMORY

ACCOMPANIMENT
 SOLO STYLE M.O.C. TRANSPOSITION PITCH

MASTER VOLUME

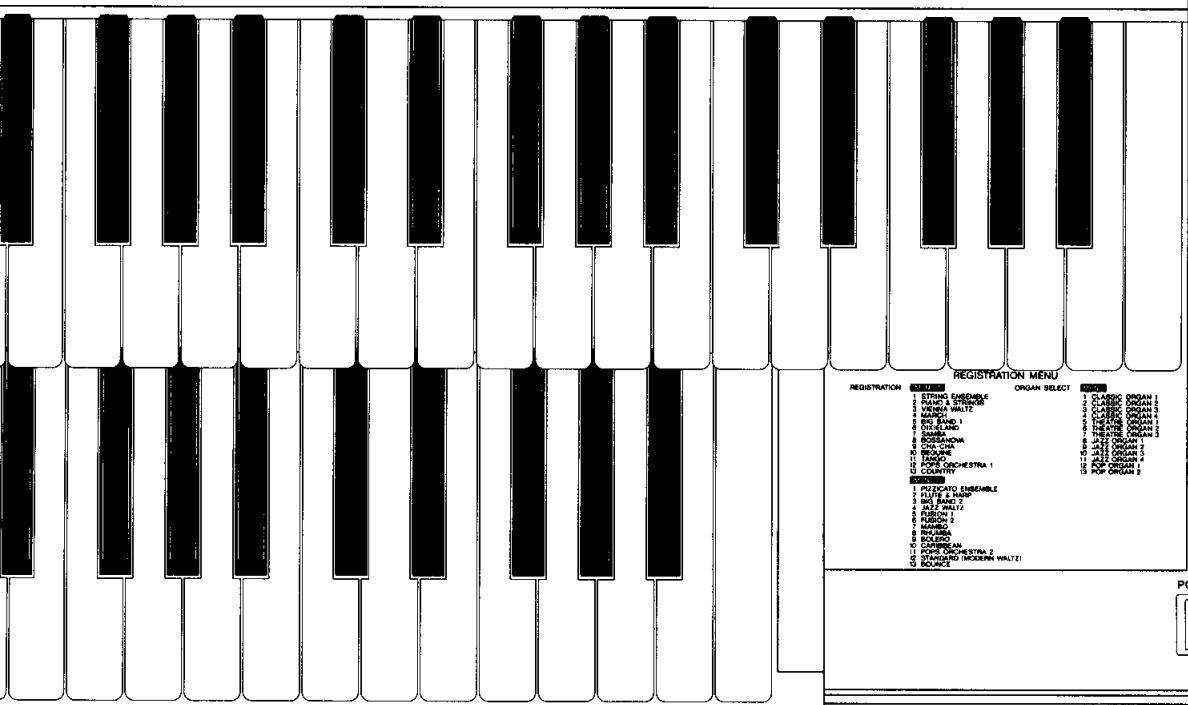

REGISTRATION MENU

REGISTRATION	ORGAN SELECT
1	STRONG ENSEMBLE
2	PIANO & STRINGS
3	PIANO WALTZ
4	PIANO
5	PIANO 2
6	PIANO 3
7	PIANO 4
8	PIANO 5
9	PIANO 6
10	PIANO 7
11	PIANO 8
12	PIANO 9
13	PIANO 10
14	PIANO 11
15	PIANO 12
16	PIANO 13
17	PIANO 14
18	PIANO 15
19	PIANO 16
20	PIANO 17

POWER

Table of Contents

	Page
Quick Introductory Guide	5
Getting Started	5
Playing Your Electone.....	6
Basic Registrations.....	6
Registration Menu.....	7
Canceling the A.B.C. Automatic Accompaniment Function	10
1 Voice Sections	11
Selecting Voices from the Panel.....	11
Selecting Additional Voices—Dotted Buttons.....	12
Additional Voice List.....	13
2 Flute Voices (EL-15)	14
3 Effects	15
Vibrato	15
Touch Tone (EL-15)	15
Sustain.....	15
Tremolo	15
4 Rhythm, Accompaniment and Percussion	16
Rhythm Patterns	16
Fill In Patterns.....	18
Accompaniment Controls.....	19
Automatic Accompaniment—Auto Bass Chord	19
Keyboard Percussion	21
Melody On Chord.....	23
SoloStyle (EL-15)	23
5 Registration Memory	24
Saving Registrations	24
Resetting the Registration Memory Buttons (Power On Reset).....	25
6 Pitch Controls	25
7 MIDI	26
8 Accessory Jacks	27
Troubleshooting	28
Specifications	29
MIDI Implementation Chart	30
MIDI Specifications.....	31
SoloStyle Voice Assignments	34

Main Features

Your Yamaha Electone is packed with many sophisticated functions. Yet it is amazingly easy to use. The main features are described here so that you can quickly understand the capabilities of your Electone.

Included among the main features are:

Astoundingly True-to-life Sounds

The new AWM (Advanced Wave Memory) and FM (Frequency Modulation; EL-15) tone generation technologies provide authentic, dynamic voices, making the Electone a truly expressive musical instrument. (See page 11.)

Variety of Organ Sounds

Both Electone models have a separate Organ Select section that provides a variety of classic organ sounds. (See page 7.) In addition, the EL-15 features Flute Voice sections for creating your own organ sounds. (See page 14.)

Dynamic Rhythm Patterns

The Rhythm section of the Electone features authentic drum and percussion sounds, used by expert rhythm programmers in creating a total of 28 rhythm patterns, ranging across all styles of music. (See page 16.) A Keyboard Percussion function is also provided for playing the realistic percussion sounds from the Lower keyboard and Pedalboard. (See page 21.)

Comprehensive Automatic Accompaniment

The Electone is also equipped with various automatic accompaniment functions, including Auto Bass Chord, Accompaniment, Melody On Chord and the exciting SoloStyle feature (EL-15). Together or individually, they provide entertaining and inspiring instrumental backing and embellishment for your performance. (See pages 19 and 23.)

Wide Selection of Registration Menus

Your Electone also has convenient Registration Menus that allow you to instantly change all settings for the entire instrument in real time, as you play. Each Registration has been specially created by professional Electone artists to match virtually any style of music you play. (See page 7.)

MIDI Compatibility

The Electone is equipped with the worldwide standard Musical Instrument Digital Interface (MIDI), allowing your Electone to control (or be controlled by) other MIDI instruments. (See page 26.)

Quick Introductory Guide

Playing Your Electone

No matter what your level of playing experience, we recommend that you take the time to go through this basic section. It shows you in the simplest possible manner how to start playing your Electone. The basic operations and functions that you learn in this section will also be important when you later use the Electone's more advanced features.

There are a few differences between the EL-15 Electone and the EL-7 Electone. Where necessary, separate instructions and notes have been provided. Please read the instructions that correspond to the particular model that you own.

Getting Started

Once you've set up your Electone and plugged the power cord into an electrical outlet, you're ready to get started and play.

1. Turn on the Electone by pressing the POWER switch.



Turning the Electone off erases all panel settings you have made. When the Electone is turned on, Basic Registration 1 is automatically selected. If you have made panel settings you wish to keep, save them to Registration Memory (see page 24) before turning the Electone off. You can, however, restore the panel settings that were made before the Electone was last turned off. In doing this, first be careful NOT to press any panel buttons (excepting those in Basic Registration) after you turn the Electone back on. Then, to restore the previous settings, hold down the M (Memory) button and press the D (Disable) button.

2. Set the MASTER VOLUME control.

The MASTER VOLUME control is an overall control which affects the volume of the entire instrument.



Set the control to roughly this position. This is the normal playing level.

3. Press the Expression pedal down with your foot.

The Expression pedal also controls the entire volume of the Electone. Once you have set the MASTER VOLUME control to a suitable level, you can use the Expression pedal to change the volume with your foot as you play.

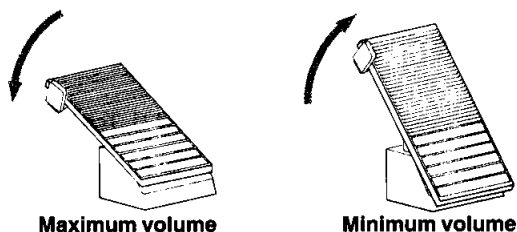

For now, press the pedal down slightly beyond the halfway point.

Playing Your Electone

Your new Electone is equipped with a wide variety of voices, rhythms, and other convenient functions. Since it may take some time to master the wealth of features available, the Electone includes convenient Registrations that let you completely and instantly change the voices and other settings for all of the keyboards, even as you play. Each registration is pre-programmed to be used for a specific music style or instrumental combination.

Basic Registrations

The Basic Registration section has five factory preset registrations, each with a different set of voices for the Upper/Lower keyboards and Pedalboard and each specially suited for playing in a different music style.

When you turn the power on, the Electone automatically selects Basic Registration 1. If another registration has been selected (the lamp on the button will be lit), press the button for Basic Registration 1.

Try playing the melody line of the following piece of music on the Upper keyboard, using the indicated registration.

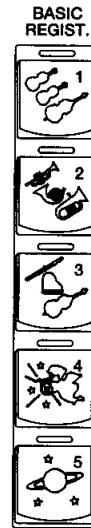

Basic Registration 1

From the New World A. Dvořák

[Pops Orch 1: EL-15; Pops Orch: EL-7]

Tempo ♩ = 82

Now, try out the rest of the Basic Registrations with the following music examples. Press the appropriate buttons to select the registrations. Each music example has been chosen to best suit its companion registration.

Basic Registration 2

Down by the Riverside Traditional

[Bigband 1: EL-15; Bigband: EL-7]

Tempo ♩ = 95

Basic Registration 3

Emperor Waltz J. Strauss

[Vienna Waltz] Tempo ♩ = 182

Basic Registration 4**Twinkle, Twinkle Little Star** *German Folk Song*

[Dixieland] Tempo ♩ =108

Basic Registration 5**Ode to Joy** *L. V. Beethoven*

[March] Tempo ♩ =123

The chart below lists the voices that have been set for the Upper/Lower keyboards and Pedalboard in each of the five Basic Registrations.

	Basic Registration 1	Basic Registration 2	Basic Registration 3	Basic Registration 4	Basic Registration 5
Upper Keyboard voice	Strings	Brass	Flute	Cosmic (1)	*(Synth. Brass)
Lower Keyboard voice	Strings	Horn	Piano	*(Cosmic 2)	*(Cosmic 3)
Pedal voice	Contra Bass	Tuba	Contra Bass	*(Cosmic 2)	*(Synth. Bass)

Note: Voices indicated by asterisks are available only in the Basic Registration section. However, they can also be stored to any of the dotted buttons for separate selection from the various voice sections. (Refer to the section, "Selecting Voices From the Dotted Buttons," page 12.)

Registration Menu

Besides the Basic Registrations, additional registrations are available on your Electone. These registrations include voice and rhythm/accompaniment selections and have been specially created by professional Electone performers to suit a variety of music styles. These additional registrations make it easy to find the perfect settings for your performance — whatever style of music you play.

Registration Menu / Organ Select

The EL-15 Electone features a total of 26 specially programmed registrations (in two banks of 13), selected with the Registration Menu buttons on the panel. (The EL-7 has one bank of 13 Registration Menu registrations.) There is also an Organ Select bank on both models that lets you call up one of 13 different organ combinations. (See the list printed on the right side of the instrument panel.)

To select a registration from Registration Menu, or an organ sound from Organ Select:

1. Select the desired bank by pressing the MENU/ORGAN SELECT button (ORGAN SELECT on the EL-7).

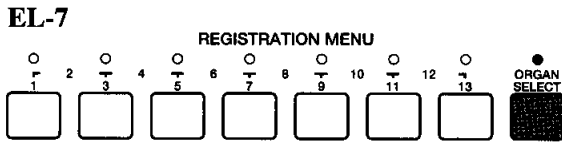

The LED indicates the selected bank:
 Off – Registration bank
 Green – Organ Select bank

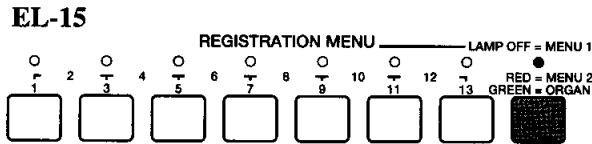

The LED indicates the selected bank:
 Off – Registration bank #1
 Red – Registration bank #2
 Green – Organ Select bank

2. Press the button (or buttons) on the panel corresponding to the desired registration (or Organ Select) number.

Select the odd numbered presets by pressing the button below the desired number. Select the even numbered presets by simultaneously pressing the two buttons below the desired number. (For example, to select number 2, press buttons 1 and 3.)

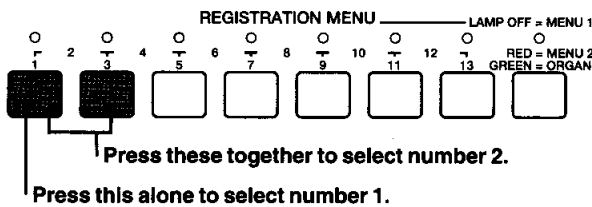

The LEDs above the buttons indicate the currently selected number. When an odd numbered preset is selected, the LED above the number will be lit. When an even numbered preset is selected, the two LEDs on either side of the number will be lit.

You can now play the registration or organ sound. If you wish, try out some of the other selections by repeating the above steps. Then go on to step #3 and try out the rhythm and accompaniment features of your Electone.

3. Once you've selected a registration (for this example, select Registration Menu 12 of the first bank), press the START button in the Rhythm section. This step starts up a rhythm pattern appropriate to the music style you have selected. (To turn the pattern off, press the START button again.)

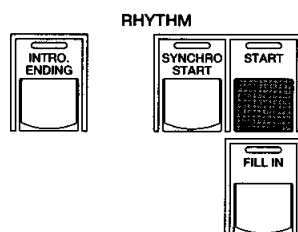

You can also adjust the tempo of the rhythm to your liking by pressing the TEMPO buttons, as indicated in the illustration below.



Rhythms are an important part of each registration. Each registration's rhythm has been carefully chosen and programmed to best match the particular music style.

The A.B.C. (Auto Bass Chord) automatic accompaniment feature of the Electone also plays an important role and is used in conjunction with the registrations and rhythm patterns. Like the rhythm patterns, A.B.C. patterns have been programmed to best match the selected registration. They allow you to add sophisticated bass and chord accompaniment patterns that suit the music, simply by playing chords on the Lower keyboard.

To use the A.B.C. automatic accompaniment feature:

4. Press a chord on the Lower keyboard. (Try the chord shown in the illustration on the right.)

This function provides automatic accompaniment specially tailored for the music style in which you play. Notice that even after you release your fingers from the keyboard, the chord and accompaniment patterns continue to sound. For more details on automatic accompaniment, see page 19.

5. Now return to the first five written music examples in the Basic Registrations section above. (See page 6.) Select the registration indicated at the top right of the score (for example, "Pops Orch (1)" in the First song). Refer back to the steps on selecting registrations above (page 8) if necessary.

6. Adjust the tempo of the rhythm for each song by pressing the Tempo buttons until the tempo number indicated in the display matches that shown at the top right of each score.

Note: Some of the registrations in the Registration Menu and Organ Select section may not have assigned rhythm and automatic accompaniment patterns.

Note: If the selected registration includes a rhythm pattern, the A.B.C. Fingered mode and Memory function are also automatically selected.

Example:



Play a C chord on the keyboard

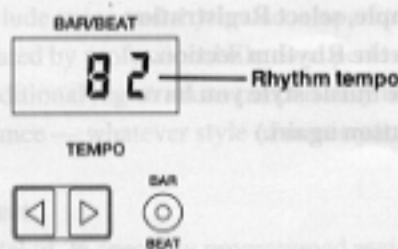

7. Play the melody line as you did before with your right hand on the Upper keyboard. This time, however, use the A.B.C. automatic accompaniment by pressing the chords with your left hand. The keys you should press are indicated by the small diagrams just below the melody in the score.

8. Now that you've heard what A.B.C. can do, try selecting other registrations from the Registration Menu. Use the A.B.C. function with these newly selected registrations as well, to get a better idea of the wide stylistic range of your Electone.

See how easy it is? And remember, you don't have to hold the key down to use the automatic accompaniment. Just press the key once and the automatic accompaniment will continue until you press the next key.

Example:

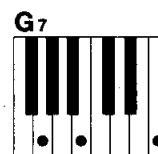

Canceling the A.B.C. Automatic Accompaniment Function

You can, of course, cancel the automatic accompaniment patterns (Fingered mode) if you want and play the accompaniment by yourself on the Lower keyboard and Pedalboard.

To cancel the A.B.C. Automatic Accompaniment:

Simply press the FINGERED CHORD and MEMORY buttons. (The LEDs above the buttons will turn off.)

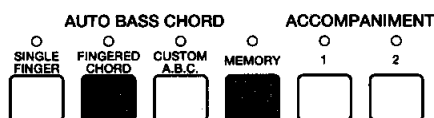

This short introductory section has shown you just a small portion of the vast potential of your Electone. Now that you know how to select among the Basic Registrations and use the A.B.C. Automatic Accompaniment, take some time to explore the other registrations and their rhythm patterns. There's a wealth of realistic voices, authentic orchestration and stylistically varied rhythms — all instantly available from the Registration Menus and Organ Select features.

Note: Before going on to explore the remaining sections of this manual, we suggest that you turn the A.B.C. automatic accompaniment and Memory functions off. Otherwise, single notes played on the Lower keyboard will sound as full chords, and the Pedal voices will not sound when playing the Pedalboard. To do this, return to the section "Canceling the A.B.C. Automatic Accompaniment Function" above and follow the instructions in turning off A.B.C. and Memory.

1 Voice Sections

The following illustration shows the the various available voice sections.

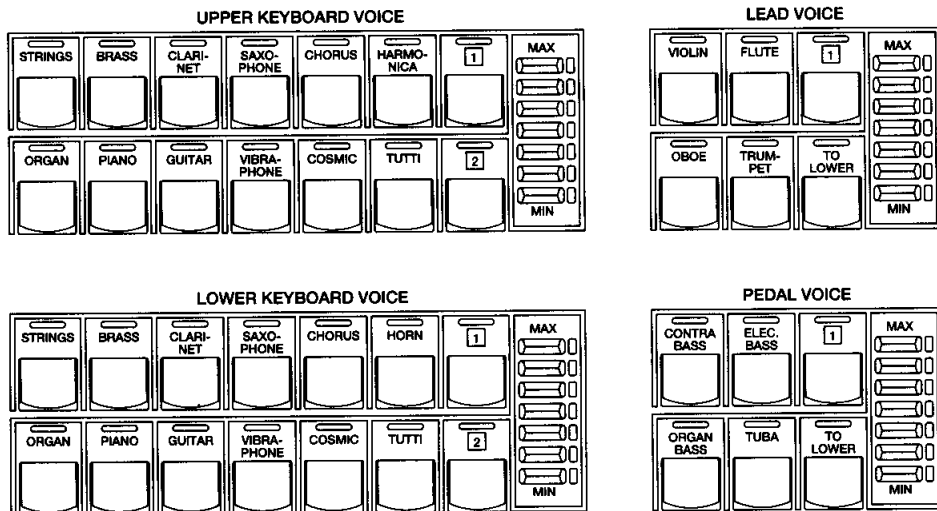

The Electone has four voice sections: Upper Keyboard Voice, Lead Voice, Lower Keyboard Voice, and Pedal Voice. All voices are playable from the Upper or Lower keyboards or Pedalboard, allowing you to create richly textured voice layers on a single keyboard.

Selecting Voices from the Panel

Since selection of panel voices follows the same procedure throughout the various voice sections, instructions for only the Upper Keyboard Voice section are given here.

1. Select a voice from the Upper Keyboard Voice section by pressing one of the Voice buttons in that section.

Note (EL-15): Voices of the Upper and Lower Flute Voice sections are selected by a different procedure. Refer to the Flute Voices section below for details.

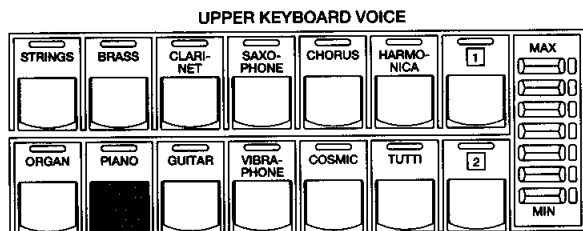

PLAYING LEAD AND PEDAL VOICES FROM THE LOWER KEYBOARD:

The Electone has a special "To Lower" function that lets you assign Lead or Pedal voices to the Lower keyboard. Simply press the TO LOWER button on the voice section you wish to assign, and that voice will be playable from the Lower keyboard.

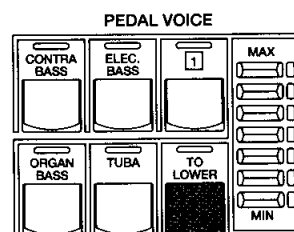
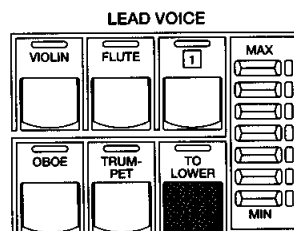

2. Set the volume for each voice section.

Use the **VOLUME** controls of each voice section on the panel to set the desired level for each voice. The controls have seven volume settings, from a minimum of 0, or no sound, to a maximum of full volume.



3. Now select voices for the Lower keyboard and Pedalboard as you did for the Upper keyboard above. Also set the volumes of the voices.

Follow steps #1 and #2 above, now using the controls of the Lower Keyboard and Pedal Voices.

Note: The Lead Voice and Pedal Voice sounds one note at a time; when you simultaneously press two or more keys, only the highest note will sound.

Selecting Additional Voices — Dotted Buttons

The Electone has a greater variety of voices from which you can choose than what is apparent from the front panel voice section controls. The Electone also has dotted buttons in each voice section, giving you access to these additional voices.

Selecting Voices From the Dotted Buttons

Each voice section has one or two dotted buttons, found on the right side of each voice section. These dotted buttons function as "wild card" voice selectors; any of the Electone's voices can be stored to and then selected from these buttons.

The dotted buttons have the following basic uses:

1) For using any voice from one of the voice sections on any other voice section. For example, you can store the Harmonica voice, which is only on the Upper Keyboard Voice section, to a dotted button in the Lower Keyboard Voice section. Another advantage to this feature is that when the normally monophonic (one note) Lead and Pedal voices are assigned to the Upper or Lower keyboard voice sections, they can be played polyphonically. The opposite is also the case: Upper or Lower voices assigned to the Lead or Pedal sections will be monophonic.

2) For using the alternate Basic Registration voices in any of the voice sections. Basic Registrations 4 and 5 include four extra voices that are not found in the voice sections. By loading any of these to the dotted buttons, they can be selected separately. (Note that these voices are directly assignable only to the same keyboard section as the one in which the voice is used.)

3) For using Registration Menu or Organ Select voices in any of the voice sections.

Note: Pizzicato Bass (Registration Menu 3 of the first bank) is one of the voices that is not included on the panel; it is also a Pedal voice. Other voices in this category include 28 different organ voices, Glockenspiel (both models), and (on the EL-15) Trombone and Electric Piano.

To select a voice from a dotted button:

1. Press and hold down one of the dotted buttons in any of the voice sections. (One of the LEDs of the panel voice buttons will flash.)

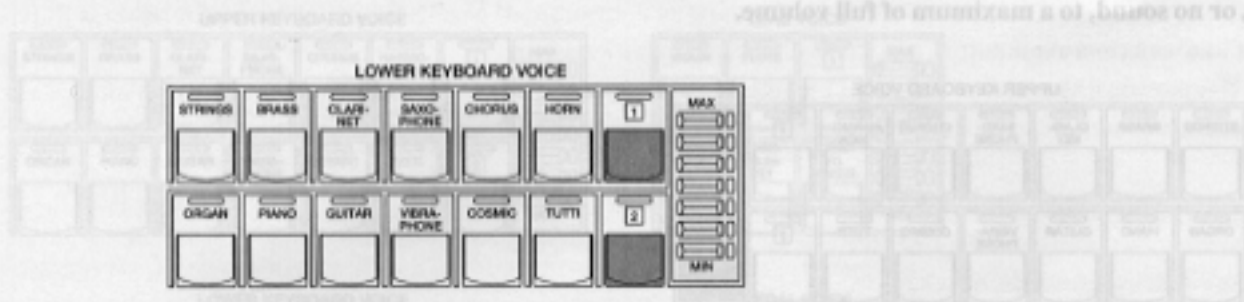

2. While holding down the dotted button, press the button of the voice you wish to store to that button.



Any of the buttons in the various voice sections (Upper, Lead, Lower and Pedal) can be used. You can also use the Basic Registration buttons and the Registration Menu buttons for selecting voices. (For details on Registration Menu/Organ Select voices, see page 7.)

Additional Voice List

Voice Name	Location	Voice Section (from which the voice can be called up)	EL-15	EL-7
Cosmic 2	Basic Registration No.4	Lower Keyboard Voice & Pedal Voice	<input type="radio"/>	<input type="radio"/>
Cosmic 3	Basic Registration No.5	Lower Keyboard Voice	<input type="radio"/>	<input type="radio"/>
Synth.Brass	Basic Registration No.5	Upper Keyboard Voice	<input type="radio"/>	<input type="radio"/>
Synth.Bass	Basic Registration No.5	Pedal Voice	<input type="radio"/>	<input type="radio"/>
Pizz. Bass	Registration Menu (1) No.3	Pedal Voice	<input type="radio"/>	<input type="radio"/>
Elec.Piano	Registration Menu 2 No.5	Upper Keyboard Voice	<input type="radio"/>	—
Trombone	Registration Menu 2 No.10	Lead Voice	<input type="radio"/>	—
Glockenspiel	Organ Select No.6	Lead Voice	<input type="radio"/>	<input type="radio"/>

* The other 28 Organ Voices can be called up by the same procedure.

2 Flute Voices (EL-15)

The Flute Voice feature allows you to create your own organ voices, giving you access to an wide variety of organ sounds. With this function, you can recreate the classic sound of conventional organs by switching on the various flute footage levels and the percussive sound.

The Upper Flute Voice section has four flute footage settings plus an Attack footage, while the Lower Flute Voice section has three flute footage settings.

To use the Flute Voice function:

1. Press any of the FLUTE VOICE footage buttons (UPPER or LOWER).

The LED above the button lights to indicate that the selected footage is on.

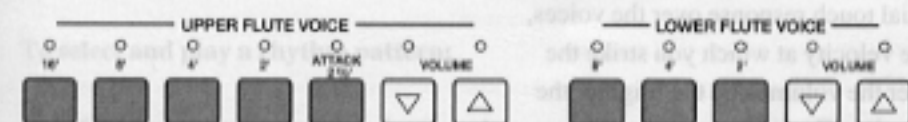

2. Use the VOLUME ▼ and ▲ buttons in the corresponding section to adjust the overall volume of the Flute Voice.



The volume is adjustable over a range of four steps. The LEDs above the buttons indicate the volume level, as shown below.

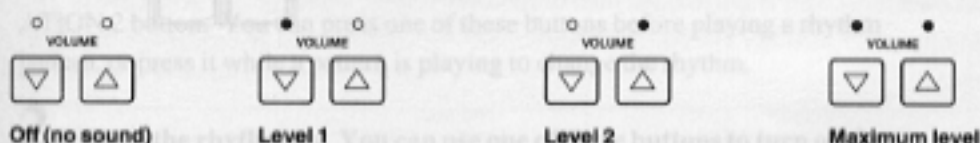

About the Footage Settings:

The footages are in octaves; for example, 16' has the lowest pitch, 8' is one octave above 16', 4' is one octave above 8', and so on. The Attack footage of 2-2/3' in the Upper Flute Voice section is an intermediate pitch and provides a short, percussive sound.

Note: When you play and hold several notes, only the first note played will have attack; all other notes played while the first is held have no attack.

SAVING FLUTE VOICES:

You can save the original organ voices that you create with the Flute Voice feature for future use. After creating a voice, save it by storing it to a Registration Memory button. (Refer to the Registration Memory section, page 24.)

3 Effects

The Electone features effects for enhancing the sound of the voices. These include Touch Tone (on the EL-15), Sustain, Tremolo and Vibrato.

The Touch Tone (on the EL-15; excepting Pedal voices) and Vibrato effects have been preset for many of the voices and cannot be changed. Sustain and Tremolo, on the other hand, have panel on/off controls.

Vibrato

Vibrato is an effect that periodically, or regularly, varies the pitch of a voice for a quavering sound.

Note: All voices of the Electone are given a preset Vibrato setting.

Touch Tone (EL-15)

The Touch Tone function gives you expressive control over the volume and timbre of a voice. Specifically, it provides initial touch response over the voices, controlling volume and timbre according to the velocity at which you strike the keys. The harder you strike the keys, the greater the volume and the brighter the timbre will become.

Sustain

Sustain is selectable for the Upper, Lower and Pedal voices and makes the sound gradually fade out when the keys are released. The Sustain on/off settings are independent for each keyboard, providing maximum expressive control.

Note: Sustain cannot be applied to the Lead voices.

To add Sustain to the voices:

Press the desired button (UPPER, LOWER or PEDAL) in the SUSTAIN section.

The lamp of the button lights up to indicate that sustain is on. Press the button again to turn sustain off.

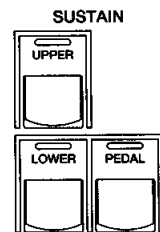

Tremolo

Tremolo is used on the Organ Select and Flute Voice (EL-15) voices and recreates the rich, swirling sound of the popular rotating speaker effect. Just as with a conventional rotating speaker, you can switch the effect on and off as you play. And like a motor-driven speaker, the characteristic tremolo effect gradually changes speed after it is switched. Tremolo can be switched in real time as you play with the TREMOLO (FAST) button on the panel.

Note: For some organ sounds, Tremolo may not be applied.

To add Tremolo to the voices:

Press the TREMOLO (FAST) button to turn the Tremolo effect on and off while you're playing.

This button functions just like the fast/slow switch on an actual rotating speaker cabinet. When Tremolo is on, the rotation effect is fast; when it is off, the rotation is slow. The speed change is gradual, effectively reproducing the slowing down and speeding up of a rotating speaker.



4 Rhythm, Accompaniment and Percussion

The Rhythm features of the Electone use actual drum and percussion sampled sounds to automatically play various rhythm patterns. Automatic Accompaniment functions are used with the rhythm patterns, providing appropriate and completely automatic accompaniment to match the style of the rhythm pattern selected. Moreover, the Electone has a Keyboard Percussion feature that allows you to play drum and percussion sounds from the Lower keyboard and Pedalboard.

Rhythm Patterns

The Electone features 28 different rhythm patterns in various styles that can be instantly selected from the front panel.

To select and play a rhythm pattern:

- 1.** Choose a rhythm pattern by pressing one of the buttons in the Rhythm section on the panel.

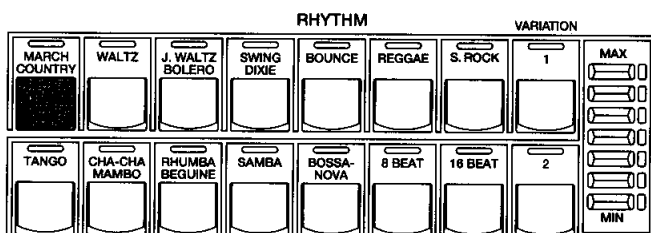

There are two types of rhythm patterns assigned to each Rhythm button, selectable with the VARIATION 1 and 2 buttons. Select the rhythm patterns of the top row with the VARIATION 1 button and those of the bottom row with the VARIATION 2 button. You can press one of these buttons before playing a rhythm pattern, or press it while a pattern is playing to change the rhythm.

- 2.** Turn the rhythm on. You can use one of three buttons to turn on the rhythm:

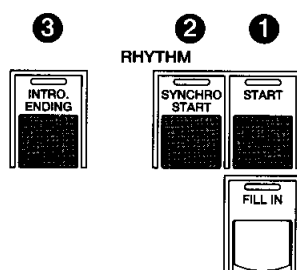

1 START

This button does as its name indicates; the rhythm begins as soon as the button is pressed. To stop the rhythm, press this button again.

2 SYNCHRO START

This button puts the rhythm pattern in "stand-by"; the rhythm will start when you press a note on the Lower keyboard or Pedalboard. To stop the rhythm, press this button again.

3 INTRO. ENDING

Pressing this button automatically plays a short introduction (of up to eight measures) before starting the actual rhythm pattern. First, press the INTRO. ENDING button, then the START or SYNCHRO START buttons. While the introduction is playing, the TEMPO Display shows the countdown to the first measure of the pattern. For example, if there is an eight-measure lead-in for a pattern in 4/4 time, the following display appears:



Pressing the INTRO. ENDING button again while the pattern is being played will automatically add an ending phrase before stopping the rhythm.

LEAD IN
Pressing the START button while holding down the INTRO. ENDING button automatically plays a special one-measure Lead In, with a click on each beat, to cue you in to the beginning of the song.

Footswitch (Rhythm Stop)

You can use the left footswitch to turn the rhythm off and on in the middle of a song. However, it cannot be used to start the rhythm at the beginning of a song.

ABOUT SYNCHRO START:
The Synchro Start feature functions quite differently when Auto Bass Chord is turned on and Memory is turned off. The rhythm pattern starts when a key on the Lower keyboard is played, but then immediately stops when the key is released. To keep this from happening, turn the Memory function on. (Refer to the Automatic Accompaniment section, page 19, for details on Auto Bass Chord and Memory.)

3. Set the volume.

Press the VOLUME controls to the right of the Rhythm Select buttons to set the desired level of the rhythm. The controls have seven volume settings, from a minimum of 0, or no sound, to a maximum of full volume.

Note: When the Electone is turned on, the rhythm volume is automatically set to 0.

4. Set the tempo.



1 TEMPO Buttons

For adjusting the speed of the rhythm. Press the ► button to increase the tempo, and press the ◀ button to decrease it.

2 TEMPO Display

Shows the current tempo. (Displayed values are given in beats per minute, just as on a conventional metronome.) The tempo range is 40 to 240 beats per minute.

Note: Each rhythm pattern has its own pre-set tempo. Pressing both tempo buttons simultaneously restores this preset tempo if it has been changed.

When the rhythm pattern begins playing, the TEMPO display changes function to a bar/beat indicator.



The number on the left indicates the current bar or measure and the one on the right indicates the number of the beat in each bar. The beat indicator lamp below the display also indicates the beats.

Fill In Patterns

Fill In patterns are designed to be used as temporary and regular rhythmic breaks to spice up a repeating rhythm pattern. Like the regular rhythm patterns, all Fill In patterns have been designed to perfectly match the bass and chord parts of the Automatic Accompaniment feature.

To use the Fill In patterns:

- 1. Select and play a rhythm pattern.**
- 2. As you play the Electone along with the rhythm pattern, occasionally press the FILL IN button.**

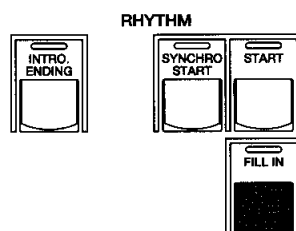

For best results, press the FILL IN button just at the beginning or the first beat of a measure.

Note: Fill In patterns can also be used as introductions; simply press the FILL IN button before starting the rhythm with the START or SYNCHRO START buttons.

Note: You can also start Fill In patterns within a bar, in order to play only the final one or two beats of the Fill In pattern and create additional rhythmic interest. Since the Fill In feature is very sensitive to bar/beat boundaries, you should be very careful to "play" the FILL IN button precisely on (or just slightly before) the beat that you want the Fill In pattern to begin.

Accompaniment Controls

The Accompaniment function here is independent of the A.B.C. accompaniment and works with the Rhythm section to automatically add arpeggiated chords and other instrumental embellishments.

To turn on the Accompaniment function:

1. Press the ACCOMPANIMENT 1 or ACCOMPANIMENT 2 button on the panel. The LED above the selected Accompaniment type will be lit.

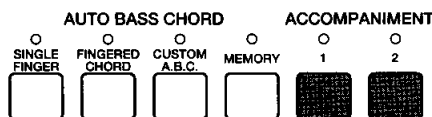

The two types provide different rhythmic and melodic accompaniment, Type 2 being more complex than Type 1.

2. While the rhythm pattern is playing, play a chord on the lower keyboard.

Note: Even if the Accompaniment Type is changed, the Intro/Ending pattern remains the same.

Automatic Accompaniment — Auto Bass Chord

The Auto Bass Chord (A.B.C.) function works with the Rhythm section of the Electone to automatically produce chord and bass accompaniment as you play. Depending on the feature or mode selected, you can play anything from a single note to a full chord on the Lower keyboard and hear complete, rhythmical bass and chord accompaniment.

There are three Auto Bass Chord modes — SINGLE FINGER, FINGERED CHORD and CUSTOM A.B.C. — and they are selected from the buttons in the AUTO BASS CHORD section.

Note: The MEMORY button does not select a mode, but is a separate setting for each of the modes. (Refer to the section on Memory below.)

To use the A.B.C. function:

Press the desired button in the AUTO BASS CHORD section. The LED above the selected mode will be lit.

To turn off the A.B.C. function, press the same button again (or the button whose LED is currently on).

About the Auto Bass Chord Modes and Memory:

Single Finger mode

The Single Finger mode provides the fastest and easiest means to obtain many different chord/bass combinations, by simply using one, or at most, two or three fingers to play the chords.

Refer to the chart below, "Chords Recognized in the Single Finger Mode," for details on playing chords in this mode.

Fingered Chord mode

The Fingered Chord mode automatically produces bass and chord accompaniment for chords played in the Lower keyboard. It allows you to use a wider range of chord types than in the Single Finger mode. In the Fingered Chord mode, you play all the notes of the chord while the Auto Bass Chord function automatically selects the appropriate bass pattern and rhythmic accents.

Refer to the chart below, "Chords Recognized in the Fingered Chord Mode," for details on playing chords in this mode.

Custom A.B.C. mode

The Custom A.B.C. mode is a slight variation on the Fingered Chord mode. It allows you to determine what bass notes will be played in the accompaniment by playing a note on the Pedalboard along with the chords you play in the Lower keyboard. In this way, you have greater control over the actual notes of the accompaniment and the freedom to use a wider variety of chords and voicings, yet are still able to take advantage of the automatic accompaniment capabilities of the Auto Bass Chord feature.

Memory

The Memory function allows you to have the bass and chord accompaniment continue even after you release your fingers from the keyboard. When used with a rhythm pattern, Memory can also function independently from the A.B.C. feature to allow the bass and chord notes that you play sustain after you release them. Press the MEMORY button to turn on the Memory function. (The LED above the button will light up.) Press it again to turn it off.

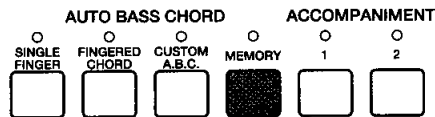

Note: When the Custom A.B.C. mode is selected, the Memory function is applied only to the bass accompaniment.

Chords Recognized in the Single Finger Mode (Key of C)

Major, minor, 7th and minor 7th chords can all be played in the Single Finger mode.

Major chords:

Press the root of the chord (the note that corresponds to the chord's name).



Minor chords:

Simultaneously press the root and any one black key to the left of it.



7th chords:

Simultaneously press the root and any one white key to the left of it.



Minor 7th chords:

Simultaneously press the root as well as any black key and any white key to the left of it.



Chords Roots on the Lower Keyboard

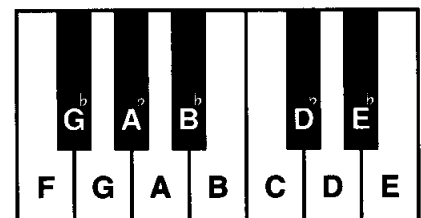

Note: Minor, 7th and minor 7th chords with black key roots (such as Bb or Gb) are played in the same way as those with white key roots.

Note: With Single Finger, the chord produced will sound in the same octave regardless of where it is played on the Lower keyboard.

PLAYING SINGLE FINGER CHORDS WITHOUT RHYTHM:

Auto Bass Chord is generally used with rhythm patterns to create full rhythmic accompaniment, but it can also be used in the Single Finger mode to add full continuous chords to your performance without the use of the rhythm. Simply leave the rhythm off in Single Finger mode, and play Single Finger chords from the Lower keyboard.

Note: If you forget to cancel the Single Finger or Fingered Chord accompaniment functions, single notes that you play will be sounded as continuous chords.

Chords Recognized in the Fingered Chord Mode (Key of C)

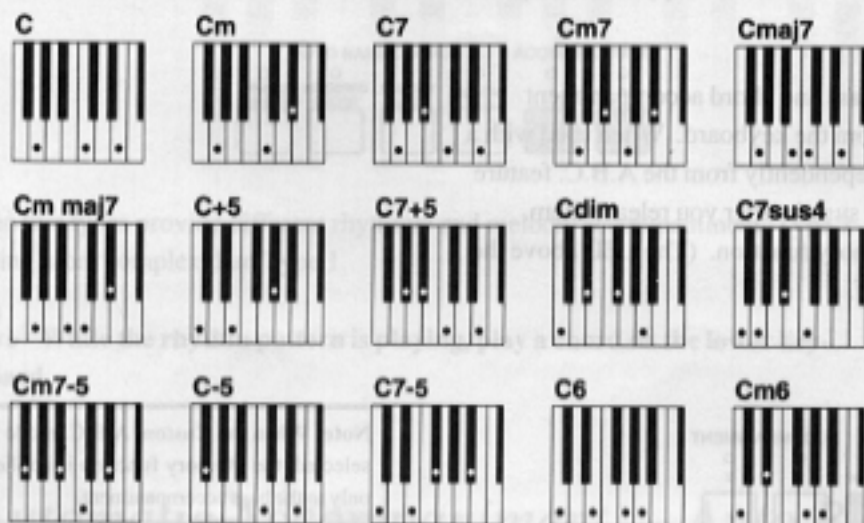

Keyboard Percussion

To play the Keyboard Percussion sounds:

1. Turn on the Keyboard Percussion function by pressing either or both the LOWER and PEDAL buttons in the KEYBOARD PERCUSSION section.

KEYBOARD PERCUSSION



RHYTHM



2. Set the volume.

The volume of the percussion sounds is set together with that of the rhythm by using the VOLUME controls in the Rhythm section. Set the volume to the desired level.

3. Turn off all the Lower and Pedal voices by setting each voice's volume to MIN.

4. Play some notes on the Lower keyboard and Pedalboard. The various percussion sounds (a total of 42 are available) have been assigned to the keyboards as shown in the charts below.

Refer to the chart below, "Chords Recognized in the Fingered Chord Mode," for details on playing chords in this mode.

Percussion Assignments for the Lower Keyboard

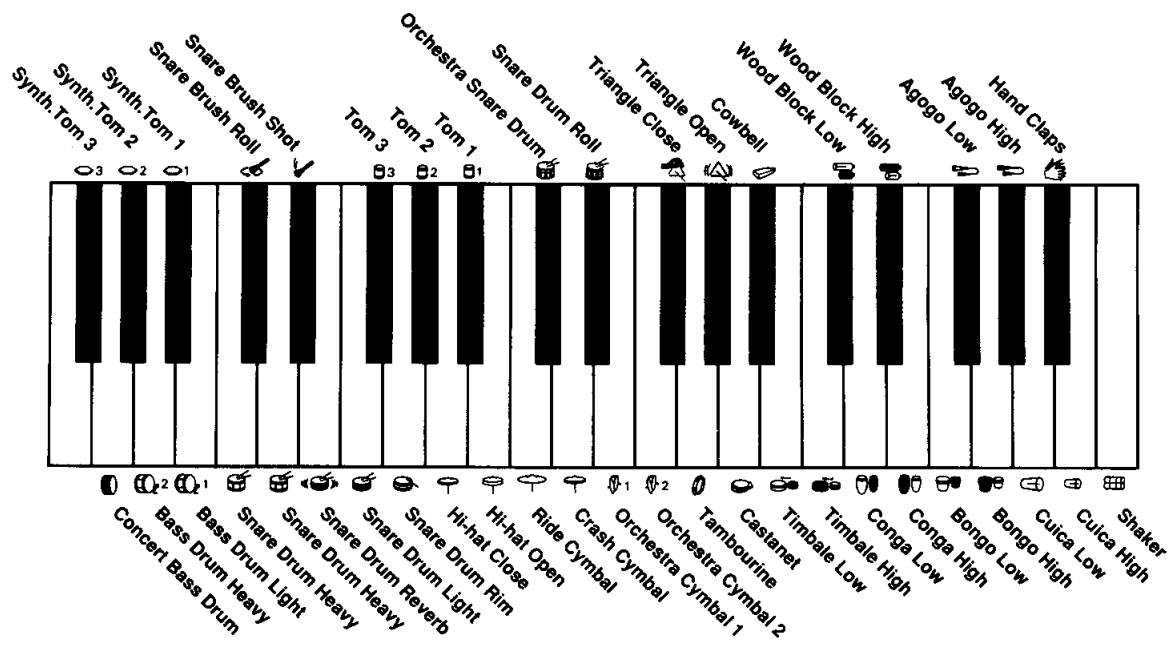

Percussion Assignments for the Pedalboard

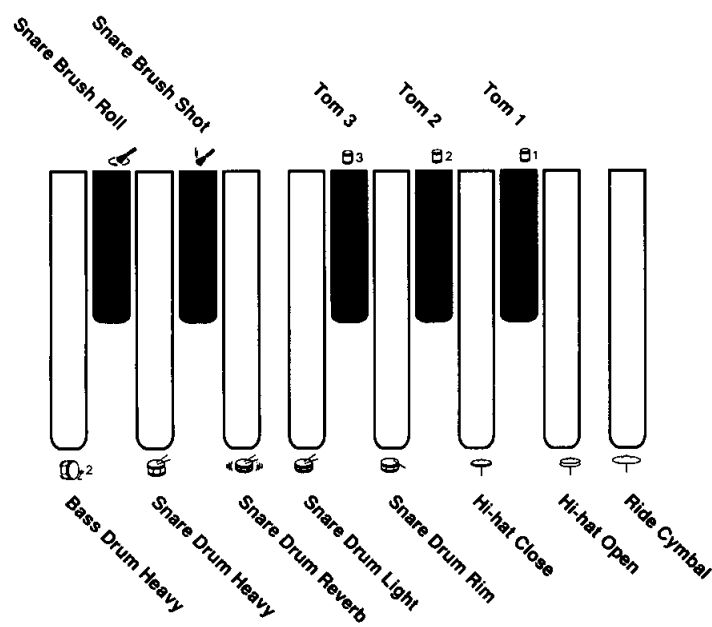

Melody On Chord

The Melody On Chord (M.O.C.) feature automatically adds a harmony part to the melodies you play on the Upper keyboard. The harmony is derived from the chords you play on the Lower keyboard — or from the chords that are played for you, if you use A.B.C. Automatic Accompaniment.

To select the Melody On Chord function:

Press the M.O.C. button. (The LED above the button will light up.) Press it again to turn it off.



Note: Even when Melody On Chord is on, if the Upper keyboard voices are set to 0, the function will not sound.

SoloStyle (EL-15)

The SoloStyle function generally works with the rhythm patterns and automatically produces various kinds of musical embellishments (harmonies, delayed repeats, or sequenced phrases) to the Lead voice you play on the Upper keyboard. There are 28 different SoloStyle patterns, one for each of the rhythm patterns.

When turned on, SoloStyle automatically sets the volume of the Lead voice to nearly the maximum level and plays the ideal embellishment to match the rhythm style. (Refer to the SoloStyle Voice Assignments List, page 34.)

To select the SoloStyle function:

Press the SOLOSTYLE button. (The LED above the button will light up.) Press it again to turn it off.

Note: The Accompaniment type cannot be changed.

Note: Melody On Chord and SoloStyle are highly distinctive effects, and as such it may not be musically appropriate to keep them on for the duration of a song. Use the corresponding panel buttons to turn the functions on and off as necessary; this is a convenient way to add dynamic changes to your performance as you play.

5 Registration Memory

Registration Memory allows you to store virtually all the settings you make, providing a convenient way to instantly change all voice settings and rhythms while you're playing, with the simple touch of a single button in the REGIST. MEMORY section.

Virtually all of the front panel settings can be memorized to Registration Memory.

The following settings cannot be memorized:

Pitch/Transpose settings

Saving Registrations

Newly created registrations you make can be saved to the Registration Memory panel buttons. All registrations in Registration Memory can also be saved to disk for future recall (when equipped with an optional Yamaha Music Disk Recorder).

To store registrations to the Registration Memory:

1. After creating your original registration, decide which numbered button you wish to replace (1 - 5).
2. While holding down the M (Memory) button in the Registration Memory section, press the numbered button to which you wish to save your registration.

When the registration is stored, the numbered button flashes momentarily.

To select registrations from Registration Memory:

Simply press the numbered button that corresponds to the registration you wish to select.

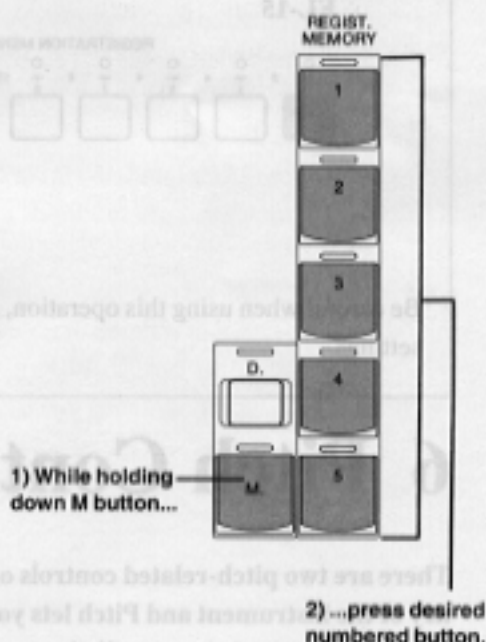

USING THE D (DISABLE) BUTTON:

Rhythm and automatic accompaniment patterns also change when you select different Registration Memory buttons. Pressing the D (Disable) button allows you to keep the same rhythm and accompaniment patterns throughout all your registration changes.



Resetting the Registration Memory Buttons (Power On Reset)

All current registrations can be deleted at once by using the Power On Reset function. This replaces the registrations you stored with the preset registrations loaded at the factory. To do this:

1. Turn off the power.
2. While holding down the leftmost Registration Menu button (button 1), turn the power back on.

EL-7

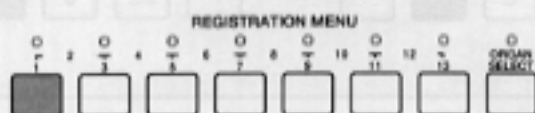

POWER



EL-15

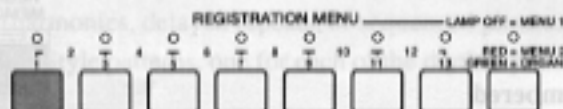

Be careful when using this operation, since it erases all your Registration Memory settings.

6 Pitch Controls

There are two pitch-related controls on the Electone: Transposition and Pitch. Transposition allows you to change the key of the instrument and Pitch lets you finely adjust the tuning. These features make it easy to change the key of a song to accommodate a vocalist's range or to precisely match the tuning of another instrument. The Transposition and Pitch controls are located at the far right of the panel, next to the MASTER VOLUME dial.

Transposition

To transpose the key of the Electone, use the TRANSPOSITION ▼ and ▲ buttons. The LEDs above the buttons light to indicate the current direction of transposition, up or down. (Both LEDs are off when transposition is normal.)

This setting determines the coarse pitch of all the voices, and it is adjustable in half-steps (semitones). Range: -6 — +6 (one octave)



Pitch

To change the overall pitch setting of the Electone, hold down the PITCH button and press either of the TRANSPOSITION ▼ and ▲ buttons.

This determines the fine pitch setting of all the voices. Range: 438.8 Hz — 444.5 Hz



7 MIDI

MIDI (Musical Instrument Digital Interface) is a sophisticated communication system for electronic musical instruments. It is built into most every modern digital musical instrument and allows different instruments to "talk" to each other and control each other's functions. For example, the Upper keyboard of your Electone could be used to play sounds on a connected synthesizer. In another application, a rhythm machine can be programmed to play its rhythm patterns in perfect synchronization with the tempo set on the Electone.

To use the MIDI functions you must, of course, have a second MIDI device (such as a synthesizer or rhythm machine), and a set of MIDI cables. Connect the MIDI cables as shown in the illustration below:

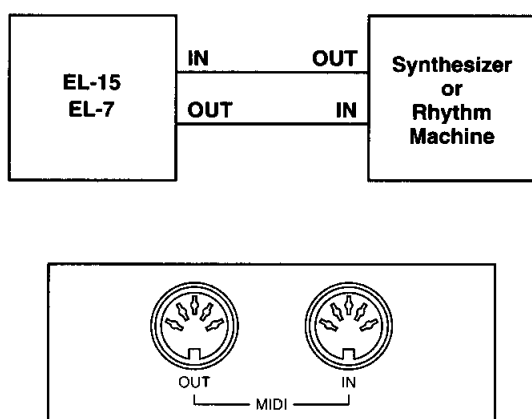

This determines the channels over which MIDI information will be transmitted. The Upper keyboard can be set to send over channel 1, while the Lower keyboard can send over channel 2. The Pedalboard sends over channel 3. The MIDI receive channel of each connected MIDI device should match the numbers set here.

When using another MIDI device to play the Electone's voices, you must set the MIDI transmit channel(s) of the connected device to match the receive channel(s) of the Electone. Similarly, when using the Electone to play sounds on a connected device, the receive channel settings on the device must match the transmit channel settings on the Electone. The MIDI transmit and receive channels of the Electone are automatically set to the following values:

Upper: 1
Lower: 2
Pedal: 3
Keyboard Percussion: 15 (receive channel only)

Note: Accompaniment pattern sounds cannot be controlled via MIDI.

8 Accessory Jacks

On the left underside of the Electone keyboard is a separate panel equipped with various input/output terminals, the functions of which are described below.

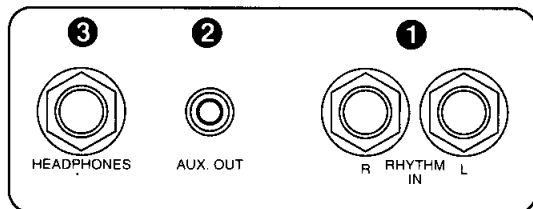

❶ RHYTHM IN — Left and Right (EL-15)

This pair of phone jacks are for connection to an external rhythm machine. The sound of the connected device is mixed with the sound of the Electone and played through the speaker system. The volume of the rhythm machine can be controlled by the Expression pedal of the Electone.

❷ AUX. OUT

This output (RCA pin jack) is for connection to external amplification/speaker systems, such as a home audio system or cassette deck.

❸ HEADPHONES

For connection of a stereo or monaural headphone set. When headphones are connected to this jack, sound to the Electone's built-in speaker system is automatically cut off, allowing you to play without disturbing others.

Troubleshooting

Please note that the appearance of any of following phenomena does not indicate a mechanical failure of the Electone.

Problem	Possible Cause and Solution
GENERAL OPERATION	
No sound is produced from the Electone's speakers.	The plug of the cable from the speaker unit is disconnected. Refer to the separate "Assembly Instructions," and reconnect the plug securely.
A crackling noise is sometimes heard.	Noise may be produced when either an electrical appliance is turned on or off, or an electric power tool (such as a drill) is used in the proximity of the Electone. If this occurs, plug the Electone into an electrical outlet located as far as possible from the device that seems to be the source of the problem.
Interference from radio, TV, or other sources occurs.	This is caused by the proximity of a high-power broadcasting station or amateur ham radio setup.
The sound of the Electone causes surrounding objects to resonate.	Because the Electone is capable of producing powerful bass sounds, resonance may be caused in surrounding objects, such as cabinets or glass windows. To avoid this, relocate the objects or lower the Electone's volume.
The Electone panel does not function normally or the content of the memorized data has changed.	This happens very rarely. Occasionally, power surges and spikes due to electrical storms or other reasons may cause the Electone to malfunction and/or alter the contents of memorized data. If this happens, perform the Power On Reset operation to reset the Electone. (See page 25.)
VOICES/RHYTHMS	
When too many keys are pressed, not all of the notes sound.	Total polyphonic capacity (notes sounding for both Upper and Lower keyboards) is 11 notes on the EL-15, and 10 on the EL-7. Polyphonic capacity is 11 for the Upper and Lower Flute Voices on the EL-15.
When playing a Pedal voice from the Lower keyboard (using the To Lower function), pressing the Lower keyboard's Sustain button does not turn on Sustain.	Even though the Pedal voice is being played from the Lower keyboard, it is still a Pedal voice; turn the Sustain on with the Pedal Sustain button. (See page 15.)
The sound is too soft, despite the volume being set to the maximum.	Check all of the volume controls, making sure that they are set to suitable levels: the panel Volume controls for each voice section, the Master Volume dial, and the Expression Pedal.
When keys on the Lower keyboard or Pedalboard are pressed, the sounds of percussion instruments are also heard.	The Keyboard Percussion function has been turned on. When not using the function, be sure to turn it off. (See page 21.)
Only one sound is heard when two notes of the Lead or Pedal voices are simultaneously played.	For practical performance reasons, the Electone has been designed so that one note of the Lead or Pedal voices can be played at a time. If several keys are pressed at once, only the highest note will be sounded (high-note priority).
The Pedal voices do not sound, even when though the volume is properly set.	The Single Finger or Fingered Chord mode of Auto Bass Chord is on. Turn off the mode in the display. (See page 19.)
While an Intro./Ending pattern is automatically playing, the Lower keyboard does not produce any sound, even when the keys are played.	Since the Accompaniment chords play automatically one after another, the Lower keyboard is designed not to produce any sound during the play of an Intro./Ending pattern.
ACCOMPANIMENT AND OTHER FUNCTIONS	
Despite its volume being set to a suitable level, the Accompaniment cannot be heard.	The rhythm has not been started. Be sure to use Accompaniment together with the rhythm.
The pitch in the Single Finger mode does not change, even when pressing different keys of the keyboard.	Single Finger mode will only produce notes when played within a fixed octave interval on the Lower keyboard. If notes with the same letter name are pressed outside of that range, the chords that are sounded will share the same pitch.
The harmony notes of the Melody On Chord function cannot be heard.	The Upper keyboard has been set to sound only Lead voices. Increase the volume of the Upper voices.

Specifications

		EL-15	EL-7
KEYBOARD	Keyboards	Upper: 44 keys , Lower: 44 keys , Pedal: 13 keys	
	Touch Tone	Initial (Upper, Lower; preset for each voice)	—
VOICE	Tone Generation	New AWM & FM	New AWM
	Upper/Lower Keyboard	Strings, Brass, Clarinet, Saxophone, Chorus, Organ, Piano, Guitar, Vibraphone, Cosmic, Tutti [Upper] Harmonica, [Lower] Horn; Volume	
	Lead (Upper)	Violin, Flute, Oboe, Trumpet; To Lower; Volume	
	Pedalboard	ContraBass, Elec. Bass, Organ Bass, Tuba; To Lower; Volume	
	Upper/Lower Flute Voice	Upper: 16', 8', 4', 2', Attack 2 ² / ₃ ', Lower: 8', 4', 2'; Volume	—
MELODY ON CHORD		MOC	
SOLOSTYLE		SoloStyle	—
EFFECT	Sustain	Upper, Lower, Pedal	
	Tremolo/Chorus	Flute Voice and Organ Select	Organ Select
	Vibrato	Preset	
RHYTHM	Rhythms	March, Country, Waltz 1, 2, Jazz Waltz, Bolero, Swing, Dixieland, Bounce 1, 2, Reggae 1, 2, Slow Rock 1, 2, Tango 1, 2, Cha-cha, Mambo, Rhumba, Beguine, Samba 1, 2, Bossanova 1, 2, 8 Beat 1, 2, 16 Beat 1, 2; Volume	
	Variations	Fill-In, Intro. Ending, Lead In	
	Others	Start, Synchro Start, Tempo, Bar/Beat LED, Volume	
KEYBOARD PERCUSSION		On/Off: Lower, Pedal; 42 Sounds	
ACCOMPANIMENT	Auto Bass Chord (A.B.C.)	Single Finger, Fingered Chord, Custom A.B.C., Memory	
	Accompaniments	Type: 1, 2	
REGISTRATION MEMORY		M (Memory), 1 ~ 5; Disable Button	
BASIC REGISTRATION		1 ~ 5 (Including several different voices from the panel voices.)	
REGISTRATION MENU/ORGAN SELECT		Registration Menu: 26, Organ Select: 13	Registration Menu: 13, Organ Select: 13
LEFT FOOT SWITCH		Rhythm Stop	
OTHER CONTROLS		Power On/Off, Exp. Pedal, Pitch Control, Transpose, Master Volume	
OTHER FITTINGS		Matching Bench, Dust Cover, Music Stand, MIDI In/Out, Headphone Jack, Rhythm In (Phone; R/L), Aux Out (RCA; Mono)	Matching Bench, Dust Cover, Music Stand, MIDI In/Out, Headphone Jack, Aux Out (RCA; Mono)
OPTIONAL ACCESSORIES		MDR-3 Music Disk Recorder, YHE-5 Headphones	
SOUND SYSTEM	Power Amplifiers	40W	35W
	Speakers	20cm (8")×1; 5cm (2")×1; Monitor×2	18cm (7")×1; 5cm (2")×1
DIMENSIONS Width×Depth×Height		101 cm (39 ³ / ₄ ")×40 cm (15 ³ / ₄ ")×87 cm (34 ¹ / ₄ ")	
WEIGHT		42.0kg (92 lbs., 9 oz.)	
FINISH		Simulated Mahogany Grain	

Specifications and descriptions in this Owner's Manual are for information purposes only. Yamaha Corp. reserves the right to change or modify products or specifications at any time without prior notice. Since specifications, equipment or options may not be the same in every locale, please check with your Yamaha dealer.

MIDI Implementation Chart

Date: March 1, '92
Version: 1.1

Function		Transmitted	Recognized	Remarks
Basic Channel	Default	1 2 3 16	1 2 3 16	UK LK PK CONTROL
	Changes	*****	*****	
Mode	Default Messages Altered	Mode 3 × *****	Mode 3 × ×	
Note Number	True Voice	36-96* *****	36-96**	
Velocity	Note ON Note OFF	9nH, v= 1-127 9nH, v= 0	9nH, v= 1-127 9nH, v= 0, 8nH	
After Touch	Key Channel	× ×	× ×	
Pitch Bend		×	×	
Control Change		1 × 4 × 11 ○ 64 ×	× × ○*** ×	Modulation wheel 2nd Expression pedal Expression pedal Sustain
Program Change	Range	0-4, 112-116 32-44, 64-76 48-60 *****	0-4, 112-116 32-44, 64-76 48-60 *****	EL-15 only
System Exclusive		○	○	
System Common	Song Pos Song Sel Tune	× × ×	× × ×	
System Real Time	Clock Commands	○ ○	○ ○	*** FAH, FCH
Aux Messages	Local ON/OFF All Notes OFF Active Sense Reset	× × ○ ×	× × ○ ×	
Notes	* CH1: 53-96, CH2: 41-84, CH3: 36-48 ** CH15 only: 36-127, Others: 36-96 *** Recognized only in External mode			

Mode 1: OMNI ON, POLY Mode 2: OMNI ON, MONO
Mode 3: OMNI OFF, POLY Mode 4: OMNI OFF, MONO

○: YES
×: NO

MIDI Specifications

■ CHANNEL MESSAGES

Date: March1, '92
Version: 1.1

Code	Function	Transmitted	Recognized	Remarks
8nH, nnH (Note No.), 00H-7FH	Note OFF	× × × ×	CH 1 CH 2 CH 3 CH 15	UK LK PK Keyboard Percussion
9nH, nnH (Note No.), 00H 01H-7FH	Note OFF Note ON	CH 1 CH 2 CH 3 ×	CH 1 CH 2 CH 3 CH 15	UK LK PK Keyboard Percussion
BFH, 08H, 00H-7FH	Expression Pedal	CH 16	CH 16	CONTROL
CnH, nnH (Regist. No.)	Program Change (Registration Memory)	× × × CH 16	CH 1 CH 2 CH 3 CH 16	UK LK PK CONTROL

■ SYSTEM REALTIME MESSAGES

Code	Function	Transmitted	Recognized	Remarks
F8H	Clock	○	○	Recognized in Ext. mode
FAH	Start	○	○	
FCH	Stop	○	○	
FEH	Active Sensing	○	○	

1. Electone common messages

■ BULK DUMP Related Messages

Code	Messages	Transmitted	Recognized
F0H, 43H, 70H, 70H, 00H, (data), F7H	Bulk Dump data	×	○
01H	Request-to-Send Voice Parameter data	×	○ * 1
02H	Request-to-Receive Voice Parameter data	×	○
F0H, 43H, 70H, 70H, 10H, F7H	Request-to-Send all RAM data	×	○
11H	Request-to-Send Registration data	×	○
F0H, 43H, 70H, 70H, 20H, F7H	Request-to-Receive all RAM data	×	○
21H	Request-to-Receive Registration data	×	○
F0H, 43H, 70H, 70H, 30H, F7H	Request-to-Send Model ID data	×	○
F0H, 43H, 70H, 70H, 38H, 7FH, F7H 00H	Bulk Dump Acknowledge Ignore	○ ○	× ×

*1 EL-15 only.

■ CONTROL CHANGE

Code	Messages	Transmitted	Recognized
F0H, 43H, 70H, 70H, 40H, 48H, 7FH, F7H 00H	FILL IN 1 ON OFF	○	○
		○	○
F0H, 43H, 70H, 70H, 40H, 4BH, 7FH, F7H 00H	INTRO./ENDING ON OFF	○	○
		○	○
F0H, 43H, 70H, 70H, 40H, 50H, TIH, ThH, F7H	TEMPO	○	○

*2 The rhythm start/stop function via the left footswitch is sent and received only by real time message.

■ MDR STATUS

Code	Messages	Transmitted	Recognized
F0H, 43H, 70H, 70H, 70H, 01H, F7H 02H	PLAY Start Stop	×	○
		×	○
03H 04H	RECORD Start Stop	×	○
		×	○
05H 06H	FF ►► Start Stop	×	○
		×	○
09H	Rhythm Pointer Reset *3	×	○

*3 Only rhythm pointer reset and fast forward messages are transmitted in the rewind function.

■ OTHERS

Code	Messages	Transmitted	Recognized
F0H, 43H, 70H, 70H, 78H, SCH, NCH, F7H	Bar signal	○	○

2. EL-15, EL-7 common message

Code	Messages	Transmitted	Recognized
F0H, 43H, 70H, 78H, 00H, (data), F7H 01H 02H	Bulk Dump data	○	○
	Request-to-Send Voice Parameter data	×	○ *1
	Request-to-Receive Voice Parameter data	×	○
F0H, 43H, 70H, 78H, 10H, F7H 11H	Request-to-Send all RAM data	×	○
	Request-to-Send Registration data	×	○
F0H, 43H, 70H, 78H, 20H, F7H 21H	Request-to-Receive all RAM data	×	○
	Request-to-Receive Registration data	×	○
F0H, 43H, 70H, 78H, 41H, (data), F7H	Panel Switch Event data *2	○	○
F0H, 43H, 70H, 78H, 42H, (data), F7H	Current Registration data	○	○

*1 EL-15 only.

*2 Refer to the "Table of Switch-Related MIDI Codes."

●Table of SW MIDI codes [F0H, 43H, 70H, 78H, 41H, CODE, DATA, F7H]
Switch Code

Functions/Switches		Code	Data	Remarks
Selector	Upper Flute Voice	00H	00H-1FH	EL-15 only *1 EL-15 only *1 SW no.
	Lower Flute Voice	01H	00H-0EH	
	UK Voice	02H	00H-0DH	
	LK Voice	03H	00H-0DH	
	Lead Voice	06H	00H-04H	
	PK Voice	07H	00H-04H	
	Rhythm	0BH	02H-10H	
Volume	Upper Flute Voice	10H	00H-7FH	EL-15 only; volume data EL-15 only; volume data Volume data
	Lower Flute Voice	11H	00H-7FH	
	UK Voice	12H	00H-7FH	
	LK Voice	13H	00H-7FH	
	Lead Voice	16H	00H-7FH	
	PK Voice	17H	00H-7FH	
	Rhythm	1AH	00H-7FH	
To Lower	Lead Voice	36H	00H-01H	00H = Off 01H = On
	PK Voice	37H	00H-01H	
Sustain	UK	50H	00H-01H	00H = Off 01H = On
	LK	51H	00H-01H	
	PK	52H	00H-01H	
A.B.C.	Mode	53H	00H-03H	00H = Off 01H = Single Finger, 02H = Fingered 03H = Custom 00H = Off 01H = On
	Memory	54H	00H-01H	
M.O.C./SoloStyle		55H	00H-02H	00H = OFF 01H = M.O.C. 02H = SoloStyle (EL-15 only.)
Keyboard Percussion	LK	5BH	00H-01H	00H = Off 01H = On
	PK	5CH	00H-01H	
Disable	Disable	5FH	00H-01H	00H = Off 01H = On
Tremolo	Tremolo	60H	00H-01H	00H = Chorus 01H = Tremolo

* 1 The logical addition of the coupler value for ON of the following five settings: 01-16' (Upper only), 02-8', 04-4', 08-2', 10-ATT2 2/3 (Upper only).

3. Model-Specific messages

Code	Messages	Transmitted	Recognized
F0H, 43H, 70H, nnH, 00H, F7H 00H, (data), F7H 01H, 02H	Model ID Data	○	×
	Bulk Dump data	×	○
	Request-to-Send Voice Parameter data	×	○
	Request-to-Receive Voice Parameter data	×	○
F0H, 43H, 70H, nnH, 10H, F7H 11H	Request-to-Send all RAM data	×	○
	Request-to-Send Registration data	×	○
F0H, 43H, 70H, nnH, 20H, F7H 21H	Request-to-Receive all RAM data	×	○
	Request-to-Receive Registration data	×	○

"nnH" can be sent/received by using \$40 (EL-15) or \$42 (EL-7).

4. Electone/Single Keyboard common messages

Code	Messages	Transmitted	Recognized
F0H, 43H, 73H, 01H, 02H, F7H 03H	Request for Internal Synchronous mode	×	○
	Request for External Synchronous mode	×	○

SoloStyle Voice Assignments (EL-15)

Rhythm Style	Mode	Lead Voice	Additional Voices
1. MARCH	Harmony	Clarinet	Saxophone, Flutes
2. COUNTRY	Harmony	Piano	Pianos
3. WALTZ 1	Delay	Flute	Flutes
4. WALTZ 2	Harmony	Strings	Strings
5. J. WALTZ	Harmony	Flute	Flute, Clarinet, Saxophone
6. BOLERO	Delay	Trumpet	Trumpets
7. SWING	Harmony	Brass	Brass, Trumpets
8. DIXIE	Harmony	Piano	Pianos
9. BOUNCE 1	Delay	Cosmic	Cosmic
10. BOUNCE 2	Harmony	Vibraphone	E. Guitar, Vibraphone
11. REGGAE 1	Delay	Trumpet	Brass, Trumpet
12. REGGAE 2	Delay	Saxophone	Flute, Saxophones
13. S. ROCK 1	Harmony	Flute	Oboes, Clarinet
14. S. ROCK 2	Harmony	Strings	Strings
15. 8 BEAT 1	Sequence	Flute	Cosmic
16. 8 BEAT 2	Harmony	Chorus	Horn, Organ
17. TANGO 1	Harmony	Violin	Violin, Strings, Piano
18. TANGO 2	Harmony	Violin	Violin
19. MAMBO	Sequence	Trumpet	Trumpets
20. CHA-CHA	Harmony	Flute	Pianos, Flute
21. RHUMBA	Harmony	Saxophone	Saxophones
22. BEGUINE	Harmony	Piano	Pianos
23. SAMBA 1	Delay	Saxophone	Flutes, Saxophones
24. SAMBA 2	Delay	Flute	Flutes
25. BOSSANOVA 1	Delay	Flute	E. Guitars
26. BOSSANOVA 2	Harmony	Flute	Strings
27. 16 BEAT 1	Delay	Harmonica	Harmonicas
28. 16 BEAT 2	Delay	Trumpet	Trumpet, Saxophone, Brass

IMPORTANT SAFETY INSTRUCTIONS

INFORMATION RELATING TO PERSONAL INJURY, ELECTRICAL SHOCK, AND FIRE HAZARD POSSIBILITIES HAS BEEN INCLUDED IN THIS LIST.

WARNING—When using any electrical or electronic product, basic precautions should always be followed. These precautions include, but are not limited to, the following:

1. Read all Safety Instructions, Installation Instructions, Special Message Section items, and any Assembly Instructions found in this manual BEFORE making any connections, including connection to the main supply.

2. Main Power Supply Verification: Yamaha products are manufactured specifically for the supply voltage in the area where they are to be sold. If you should move, or if any doubt exists about the supply voltage in your area, please contact your dealer for supply voltage verification and (if applicable) instructions. The required supply voltage is printed on the name plate. For name plate location, please refer to the graphic found in the Special Message Section of this manual.

3. This product may be equipped with a polarized plug (one blade wider than the other). If you are unable to insert the plug into the outlet, turn the plug over and try again. If the problem persists, contact an electrician to have the obsolete outlet replaced. Do NOT defeat the safety purpose of the plug.

4. Some electronic products utilize external power supplies or adapters. DO NOT connect this type of product to any power supply or adapter other than one described in the owners manual, on the name plate, or specifically recommended by Yamaha.

5. WARNING: Do not place this product or any other objects on the power cord or place it in a position where anyone could walk on, trip over, or roll anything over power or connecting cords of any kind. The use of an extension cord is not recommended! If you must use an extension cord, the minimum wire size for a 25' cord (or less) is 18 AWG. NOTE: The smaller the AWG number, the larger the current handling capacity. For longer extension cords, consult a local electrician.

6. Ventilation: Electronic products, unless specifically designed for enclosed installations, should be placed in locations that do not interfere with proper ventilation. If instructions for enclosed installations are not provided, it must be assumed that unobstructed ventilation is required.

7. Temperature considerations: Electronic products should be installed in locations that do not significantly contribute to their operating temperature. Placement of this product close to heat sources such as; radiators, heat registers and other devices that produce heat should be avoided.

8. This product was NOT designed for use in wet/damp locations and should not be used near water or exposed to rain. Examples of wet/damp locations are; near a swimming pool, spa, tub, sink, or wet basement.

9. This product should be used only with the components supplied or; a cart, rack, or stand that is recommended by the manufacturer. If a cart, rack, or stand is used, please observe all safety markings and instructions that accompany the accessory product.

10. The power supply cord (plug) should be disconnected from the outlet when electronic products are to be left unused for extended periods of time. Cords should also be disconnected when there is a high probability of lightning and/or electrical storm activity.

11. Care should be taken that objects do not fall and liquids are not spilled into the enclosure through any openings that may exist.

12. Electrical/electronic products should be serviced by a qualified service person when:

- a. The power supply cord has been damaged; or
- b. Objects have fallen, been inserted, or liquids have been spilled into the enclosure through openings; or
- c. The product has been exposed to rain; or
- d. The product does not operate, exhibits a marked change in performance; or
- e. The product has been dropped, or the enclosure of the product has been damaged.

13. Do not attempt to service this product beyond that described in the user-maintenance instructions. All other servicing should be referred to qualified service personnel.

14. This product, either alone or in combination with an amplifier and headphones or speaker/s, may be capable of producing sound levels that could cause permanent hearing loss. DO NOT operate for a long period of time at a high volume level or at a level that is uncomfortable. If you experience any hearing loss or ringing in the ears, you should consult an audiologist. IMPORTANT: The louder the sound, the shorter the time period before damage occurs.

15. Some Yamaha products may have benches and/or accessory mounting fixtures that are either supplied as a part of the product or as optional accessories. Some of these items are designed to be dealer assembled or installed. Please make sure that benches are stable and any optional fixtures (where applicable) are well secured BEFORE using. Benches supplied by Yamaha are designed for seating only. No other uses are recommended.

PLEASE KEEP THIS MANUAL

YAMAHA
YAMAHA CORPORATION