

YAMAHA ELECTONE®

ME-10

WELCOME TO THE MUSICAL WORLD OF YAMAHA
WILLKOMMEN IN DER MUSIKALISCHEN WELT VON YAMAHA
BIENVENUE DANS LE MONDE MUSICAL DE YAMAHA
BIENVENIDO AL MUNDO MUSICAL DE YAMAHA

ME-10

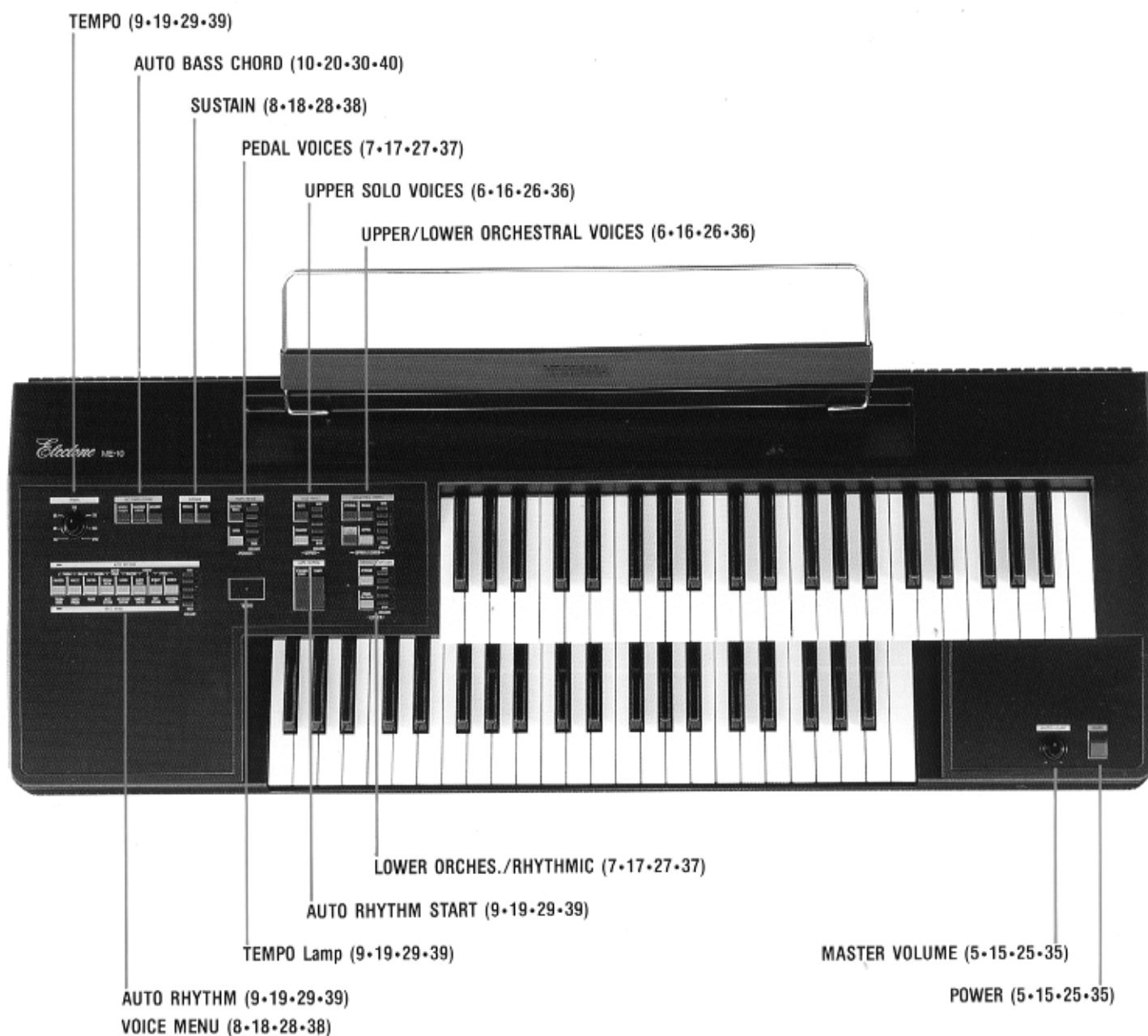

- The numbers in brackets indicate the pages in this manual where you will find an explanation of these parts and features.
- Die in Klammern angegebenen Zahlen beziehen sich auf die Seiten in dieser Bedienungsanleitung, auf denen Sie die Erklärung der betreffenden Teile und Funktionen finden.
- On trouvera de plus amples renseignements sur ces commandes et caractéristiques en consultant les pages indiquées entre parenthèses.
- Los números entre corchetes indican las páginas de este manual en las que encontrará las explicaciones sobre estas partes y características.

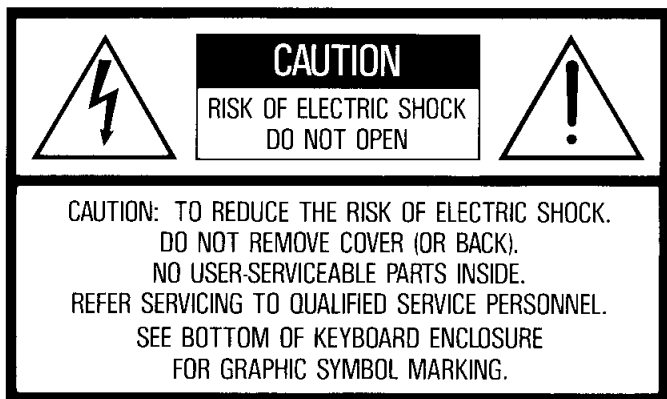

Explanation of Graphical Symbols

The lightning flash with arrowhead symbol, within an equilateral triangle, is intended to alert the user to the presence of uninsulated "dangerous voltage" within the product's enclosure that may be of sufficient magnitude to constitute a risk of electric shock to persons.

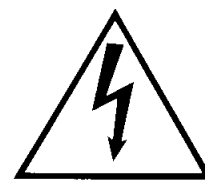

The exclamation point within an equilateral triangle is intended to alert the user to the presence of important operating and maintenance (servicing) instructions in the literature accompanying the product.



IMPORTANT SAFETY INSTRUCTIONS

WARNING—When using electric products, basic precautions should always be followed, including the following:

1. Read all the instructions before using the product.
2. To reduce the risk of injury, close supervision is necessary when a product is used near children.
3. Do not use this product near water—for example, near a bathtub, washbowl, kitchen sink, in a wet basement, or near a swimming pool, or the like.
4. This product should be used only with a cart or stand that is recommended by the manufacturer.
5. This product, either alone or in combination with an amplifier and headphones or speakers, may be capable of producing sound levels that could cause permanent hearing loss. Do not operate for a long period of time at a high volume level or at a level that is uncomfortable. If you experience any hearing loss or ringing in the ears, you should consult an audiologist.
6. The product should be located so that its location or position does not interfere with its proper ventilation.
7. The product should be located away from heat sources such as radiators, heat registers, or other products that produce heat.
8. The product should be connected to a power supply only of the type described in the operating instructions or as marked on the product.

9. This product may be equipped with a polarized line plug (one blade wider than the other). This is a safety feature. If you are unable to insert the plug into the outlet, contact an electrician to replace your obsolete outlet. Do not defeat the safety purpose of the plug.

10. The power-supply cord of the product should be unplugged from the outlet when left unused for a long period of time.

11. Care should be taken so that objects do not fall and liquids are not spilled into the enclosure through openings.

12. The product should be serviced by qualified service personnel when:

- A. The power-supply cord or the plug has been damaged; or
- B. Objects have fallen, or liquid has been spilled into the product; or
- C. The product has been exposed to rain; or
- D. The product does not appear to operate normally or exhibits a marked change in performance; or
- E. The product has been dropped, or the enclosure damaged.

13. Do not attempt to service the product beyond that described in the user-maintenance instructions. All other servicing should be referred to qualified service personnel.

SAVE THESE INSTRUCTIONS

Introduction

Thank you for purchasing a Yamaha Electone ME-10. The ME-10 is a totally new type of Electone, utilizing the very latest in electronic technology, made possible by Yamaha's experience as a musical instrument manufacturer for nearly a century. This manual has been designed to help you get acquainted with your Electone and to bring its fascinating possibilities easily within your reach. We recommend that you actually sit at your Electone while carefully reviewing these materials. Before you begin, take a moment to read the "IMPORTANT SAFETY INSTRUCTIONS" and the "Installation and Maintenance" sections which contains important information about your Electone. Thanks again for choosing Yamaha. Your fun has just begun!

Einleitung

Herzlichen Glückwunsch zum Kauf der YAMAHA Electone ME-10. Die ME-10 ist ein völlig neuer Typ von Electone mit der neuesten elektronischen Technik, ermöglicht durch die fast ein Jahrhundert lange Erfahrung von Yamaha als Hersteller von Musikinstrumenten. Diese Bedienungsanleitung wurde geschrieben, um Ihnen zu helfen, sich mit der richtigen Handhabung und Bedienung Ihrer neuen Electone ME-10 vertraut zu machen und deren faszinierende Möglichkeiten voll auszunutzen zu lernen. Um maximale Spielfreude zu erhalten, raten wir an, die Schritte dieser Bedienungsanleitung mit der Electone ME-10 vor Ihnen gleich auszuprobieren. Bevor Sie beginnen, nehmen Sie sich aber die Zeit, den Abschnitt "Vor dem Spielen" durchzulesen, der wichtige Informationen über Ihre Electone enthält. Nochmals herzlichen Glückwunsch zur Wahl von Yamaha. Ihr Spaß fängt jetzt erst an!

Introduction

Nous vous remercions sincèrement de votre achat de cet Electone Yamaha ME-10. Le ME-10 est un Electone d'un genre tout nouveau qui fait appel aux progrès les plus récents de l'électronique et dont la création a été rendue possible grâce à l'expérience acquise pendant près de 100 ans par Yamaha dans la fabrication d'instruments de musique. Ce manuel a été rédigé afin de vous aider à vous familiariser avec votre instrument et de vous permettre de profiter de ses possibilités étonnantes. Nous vous conseillons de vous asseoir devant votre Electone pendant l'étude des informations suivantes. Avant de commencer à jouer, veuillez prendre le temps de lire "Préambule" où vous trouverez des informations importantes au sujet de votre Electone. Merci de votre choix de cet instrument Yamaha et bon amusement!

Introducción

Gracias por la adquisición de este Electone Yamaha ME-10. El ME-10 es un tipo completamente nuevo de Electone, que utiliza los últimos adelantos en tecnología electrónica, y que ha sido posible gracias a la experiencia de Yamaha como fabricante de instrumentos musicales adquirida durante aproximadamente un siglo. Este manual ha sido diseñado para ayudarle a familiarizarse con su Electone serie ME y poner al alcance de sus manos sus fascinantes posibilidades. Le recomendamos que se siente ante su Electone revisando cuidadosamente este manual. Antes de comenzar, lea la sección "Antes de tocar" que contiene información importante sobre su Electone. Gracias de nuevo por haber elegido Yamaha, y ¡diviértase a placer con su Electone!

Contents

I. Before Playing	Page
● Installation and Maintenance	4
● FCC Information (USA)	4
● Let's Produce Some Sounds	5
II. The Basic Features of your Yamaha Electone	
1. Now, Let's Create Some Registrations	6
2. 7 Additional Voices Can Be Transferred	8
3. Using Sustain	8
4. Adding Rhythm	9
5. Having Fun With Automatic Accompaniment	10
III. Useful Information	
● Accessory Jacks and Optional Items	12
● Electromagnetic Interference	12
● Troubleshooting	13
● Specifications	13
● MIDI Implementation Chart	45

Inhaltsverzeichnis

I. Vor dem Spielen	Seite
● Aufstellung und Pflege	14
● Lassen Sie uns einige Töne erzeugen	15
II. Die grundlegenden Merkmale Ihrer Yamaha Electone	
1. Und jetzt ein paar Register Einstellungen	16
2. 7 zusätzliche Stimmen können übertragen werden	18
3. Einsatz von Sustain	18
4. Hinzufügen von Rhythmus	19
5. Spielvergnügen mit der automatischen Begleitung	20
III. Nützliche Informationen	
● Anschlußbuchsen für Sonderzubehör	22
● Elektromagnetische Interferenzen	22
● Störungsbeseitigung	23
● Technische Daten	23
● MIDI-Anwendungstabelle	45

Table des matières

I. Préambule	Page
● Installation et entretien	24
● Premiers pas dans la production sonore	25
II. Caractéristiques de base de l'Electone Yamaha	
1. Création de certains registres	26
2. Transfert de 7 voix supplémentaires	28
3. Utilisation du soutien	28
4. Intervention du rythme	29
5. Les prodiges de l'accompagnement automatique	30
III. Informations utiles	
● Prises accessoires et dispositifs en option	32
● Interférence électromagnétique	32
● Dépistage des pannes	33
● Fiche technique	33
● Tableau d'exploitation MIDI	45

Índice

I. Antes de tocar	Página
● Instalación y mantenimiento	34
● Antes de nada, produzcamos algunos sonidos	35
II. Características básicas de su Electone	
1. Ahora, creemos algunos registros	36
2. Posibilidad de transferencia de 7 voces adicionales	38
3. Empleo de sostenido	38
4. Adición de ritmos	39
5. Disfrute de acompañamiento automático	40
III. Información útil	
● Tomas para accesorios e ítems opcionales	42
● Interferencia electromagnética	42
● Solución de problemas	43
● Especificaciones	43
● Tabla de implementación de MIDI	45

Installation and Maintenance

● Installation

- 1. WARNING:** Do not allow your Electone or its bench to rest on or be installed over power cords of any type. An electrical shock and/or fire hazard could possibly result from this type of improper installation.
- 2. WARNING:** Do not place objects on your Electone power cord or place it in a position where anyone could trip over, walk on or roll anything over it. An improper installation of this type creates a personal injury/fire hazard possibility.
- 3. Main Power Supply Verification:** Your Electone has been manufactured specifically for the main supply voltages used in your area. If you should move, or if any doubt exists, please consult your local authorized Electone dealer for instructions. The main supply voltage is printed on the name plate.

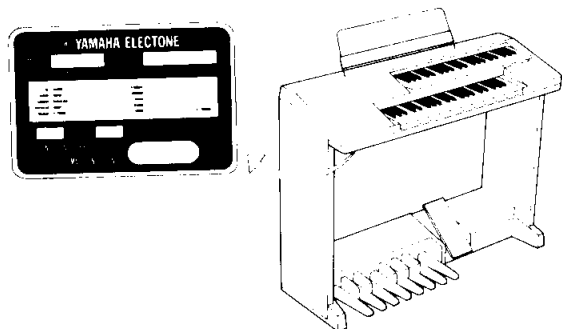

- 4. Environment:** Your Electone should not be installed in a position that exposes the cabinet to direct sunlight or air currents having high humidity or heat levels. This type of installation can cause contact oxidation, case joint separation, and cabinet finish problems.
- 5. Vinyl Products:** Do not set vinyl items, (i.e., headphones, vinyl doilies, etc.) on the finished surfaces of your Electone or use a polyvinyl material to cover the unit for any extended period of time. A chemical reaction may occur between the finish chemical and those contained in the polyvinyl products resulting in a permanent marring of the finish.
- 6. Electromagnetic Interference (RFI):** Your Electone has been type tested and found to comply with all applicable regulations. However, if it is installed in the immediate proximity of other electronic devices, some form of interference may occur.

● Maintenance

- 1. SERVICE:** Your Electone contains no user serviceable components. Refer all service to qualified service technicians only.
- 2. BENCH STRUCTURAL INTEGRITY:** If any motion or an "unsteady" sensation is noted in the bench, please check its structural integrity immediately. Discontinue use until any and all discrepancies are resolved.
- 3. CLEANING/CARE**
 - A) GENERAL:** DO NOT use chemically harsh (i.e., alcohol, paint thinners, etc.) or abrasive cleaners on any portion of your Electone.
 - B) KEYS/CONTROL PANEL:** When cleaning the keys and control panels of your Electone, please use a soft absorbent-type cloth that has been dampened with a very mild solution of liquid soap and lukewarm water.
 - C) CABINET/BENCH:** Clean the cabinet portions of your Electone with a slightly dampened cloth containing a neutral cleaning agent. The cleaning agent selected should not contain a high wax content or any other substance that would have a tendency to form a "build-up" on the cabinet.
- 4. Vinyl Products:** Do not set vinyl items, (i.e., headphones, vinyl doilies, etc.) on the finished surfaces of your Electone or use polyvinyl material to cover the unit for any extended period of time. A chemical reaction may occur between the finish chemical and those contained in the polyvinyl products, resulting in a permanent marring of the finish.

IMPORTANT NOTICE: This product has been tested and approved by independent safety testing laboratories in order that you may be sure that when it is properly installed and used in its normal and customary manner, all foreseeable risks have been eliminated. DO NOT modify this unit or commission others to do so unless specifically authorized by the manufacturer. Product performance and/or safety standards may be diminished. Claims filed under the expressed warranty terms may be denied if the unit is/has been modified. The warranty of title (patent infringement, etc.) will not be defended by the manufacturer in the area(s) that relate to the modification. Implied warranties may also be affected.

FCC INFORMATION (USA)

While the following statements are provided to comply with FCC Regulations in the United States, the corrective measures listed are applicable worldwide.

The digital series of Yamaha Electones™ use frequencies that appear in the radio frequency range, and if installed in the immediate proximity of some types of audio or video devices within three meters (approximately ten feet), interference may occur.

This series of Yamaha Electones™ has been type-tested and found to comply with the specifications set for a class B computer in accordance with those specifications listed in sub-part J, part 15 of the FCC rules. These rules are designed to provide a reasonable measure of protection against such interference. However, this does not guarantee that interference will not occur.

If your Electone™ should be suspected of causing interference with other electronic devices, verification can be made by turning your Electone™ off and on. If the interference continues when your Electone™ is off, the Electone™ is not the source of the interference. If your Electone™ does appear to be the source of the interference, you should try to correct the situation by using one or more of the following measures:

- Relocate either the Electone™ or the electronic device that is being affected by the interference.
- Utilize power outlets for the Electone™ and the device being affected that are on different branch (circuit breaker or fuse) circuits, or install AC line filters.
- In the case of radio-TV interference, relocate the antenna or if the antenna lead-in is 300 ohm ribbon lead, change the lead-in to coaxial type cable.

If these corrective measures do not produce satisfactory results, please contact an authorized Yamaha Electone™ dealer for suggestions and/or corrective measures. If you can not locate an authorized Yamaha Electone™ dealer in your general area, please contact the Electone™ Service Department, Yamaha International, 6600 Orangethorpe Ave., Buena Park, CA 90620, U.S.A.

If for any reason, you should need additional information relating to radio or TV interference, you may find a booklet prepared by the Federal Communications Commission helpful: "How to Identify and Resolve Radio-TV Interference Problems." This booklet, Stock # 004-000-00345-4, is available from the U.S. Government Printing Office, Washington DC, 20402.

First, Let's Produce Some Sounds

1 First of all, make sure that the plug is firmly inserted in the wall power outlet.

2 Turn the Electone on by pressing the POWER SWITCH.



3 Set the MASTER VOLUME control. This control lets you adjust the overall volume of your instrument. For now, place it in about a 2:00 position.



4 Place your right foot on the EXPRESSION PEDAL, which controls the overall volume while playing, for increased musical expression.

Push forward with your toes to make it louder, and back with your heel to make it softer.

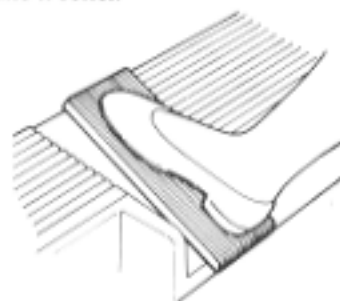

5 Next, look at the SOLO VOICES and ORCHESTRAL VOICES sections and make sure that the buttons shown in the illustration have been set.

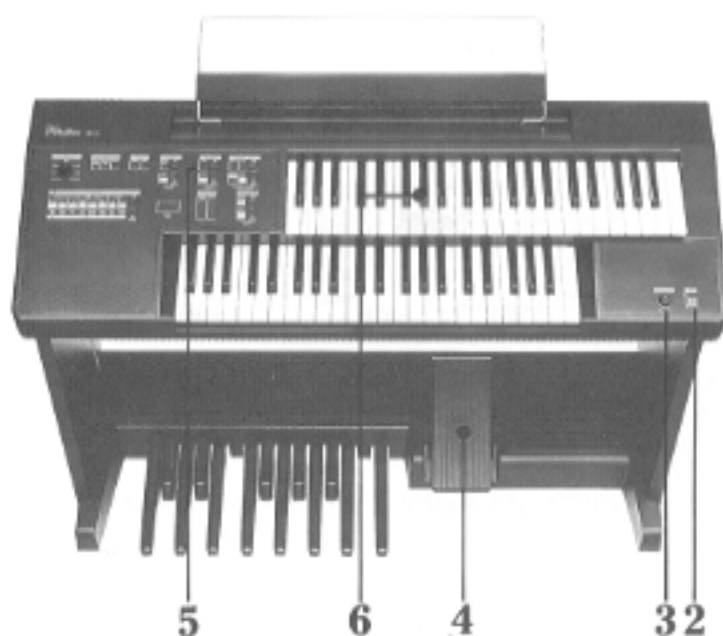
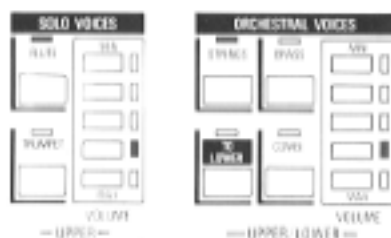

6 Now, play any keys on the Upper Keyboard. You hear a beautiful flute and strings sound, don't you? Now, let's examine each of the controls one by one.



1. Now, Let's Create Some Registrations

UPPER KEYBOARD VOICE SECTIONS

The Upper Keyboard of the ME-10 has two VOICE Sections that differ in character. Besides using them independently, you can also combine both sections.

1 Choose one sound from each section.

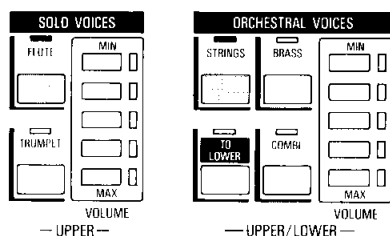

ORCHESTRAL VOICES: Besides strings and brass, this section also offers COMBINATION (traditional organ sound). These sounds are polyphonic, which means that multiple notes can be played simultaneously. (See page 7 regarding the use of the TO LOWER button.)

SOLO VOICES: This section contains voices labelled flute and trumpet. These sounds are monophonic, which means that only one note may be played at any given time.

2 Set the volume.

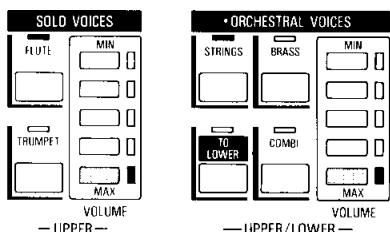

Please set the volume to the desired level for each of these sections. Your Electone lets you select one of five volume levels—the top one (MIN) being OFF and the bottom one (MAX) being full volume.

In case you do not need the sound of one of these sections, set the volume level of that section to its top position (MIN).

3 Play the upper keyboard.

The voice selected will be heard. Try changing to other voices and compare the sounds.

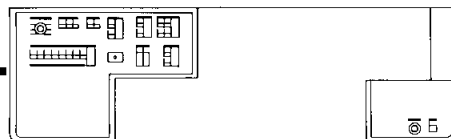
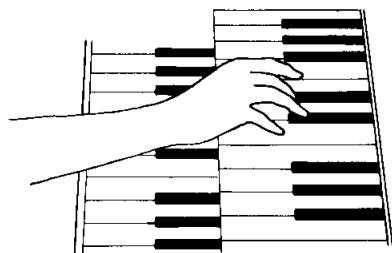

[7 Additional Voices Can be Transferred]

The seven voices in the VOICE MENU can be transferred to the grey buttons in each VOICE section (COMBI. of ORCHESTRAL VOICES; TRUMPET of SOLO VOICES, etc.), allowing you to increase versatility. (See page 8 for details.)

[Keying Priorities]

Upper and Lower keyboards: A maximum of 10 notes can be produced simultaneously. These 10 notes are available in any upper/lower keyboard ratio.

For example, if you press seven keys on the upper keyboard, only three keys will produce sound on the lower keyboard.

SOLO VOICES: When more than two notes are played at the same time, the note farthest to the right has priority.

[Additional Information]

●When TO LOWER is turned on, the ORCHESTRAL VOICES sound cannot be produced on the upper keyboard.

LOWER KEYBOARD VOICE SECTIONS

In addition to its own VOICE section (ORCHES./RHYTHMIC), the Lower Keyboard can also be used to produce the ORCHESTRAL VOICES from the Upper Keyboard.

1 Choose one sound and set the desired volume level.

ORCHESTRAL VOICES: This section consists of strings and COMBINATION (an organ sound). These sounds are polyphonic, enabling the playing of more than one note.

RHYTHMIC: When both Auto Rhythm and Auto Bass Chord are used, the COMBI. button switches to Piano and is synchronized with the rhythm for backing and accompaniment. (See page 10 for details.)

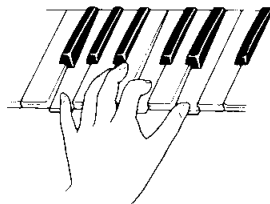
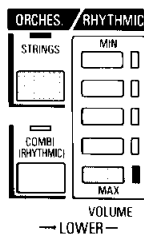

2 Play the lower keyboard.

Try the other sounds and compare them.

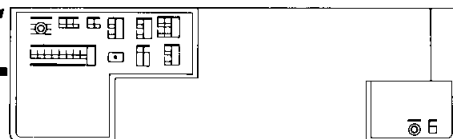

[TO LOWER]

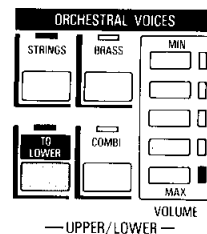

If the TO LOWER button is turned on, the sounds of the strings, brass or combination (including any voice transferred to COMBI from the VOICE MENU) can be produced on the lower keyboard. When the Rhythmic Voice is set using the lower ORCHES./RHYTHMIC section, the use of TO LOWER enables the combined sound of Rhythmic and Orchestral Voices.

[7 Additional Voices Can be Transferred]

The seven voices of VOICE MENU can also be transferred to the two buttons of the lower ORCHES./RHYTHMIC section. (See page 8 for details.)

PEDAL KEYBOARD VOICE SECTION

This section consists of the electric bass and traditional organ bass voices.

1 Select a bass sound and set the desired volume level.

NOTE: In order to hear the pedal sounds, please be sure that the SINGLE FINGER and FINGERED CHORD buttons (Auto Bass Chord Section) are turned OFF.

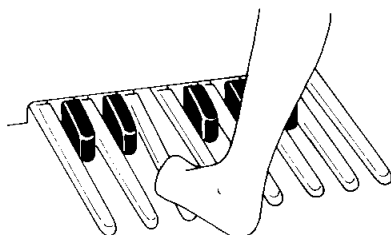
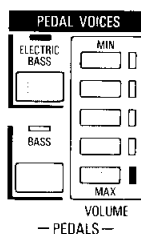

2 Press a pedal.

Try the other bass sound in this section.

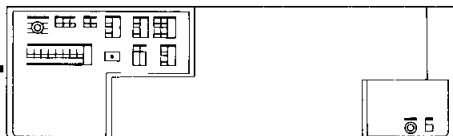

[7 Additional Voices Can be Transferred]

The seven voices of the VOICE MENU can be freely transferred to the grey button (BASS).

[Keying Priorities]

When more than two pedals are played at the same time, the pedal farthest to the right has priority.

2. 7 Additional Voices Can Be Transferred

VOICE MENU

Your ME-10 has seven additional voices which can be used by transferring them to any grey buttons in any VOICE section.

1 Determine which voice to transfer and which section you wish to transfer that voice to.

These voices in the VOICE MENU section can be transferred to any of these grey buttons from the VOICE section.

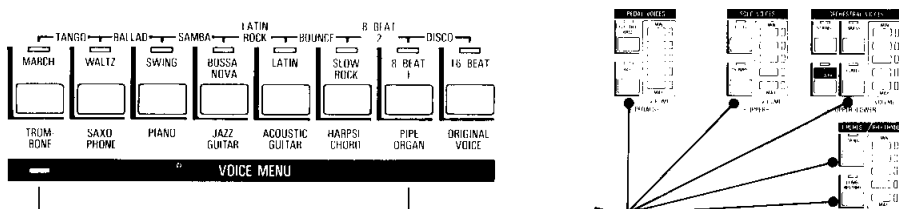

2 While depressing the grey button in the VOICE section where you wish to transfer the sound, press the button of the voice to be transferred.

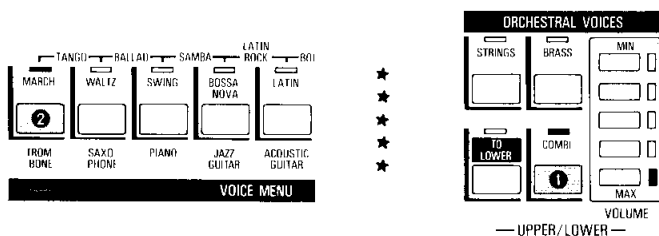

When a grey button is pressed, the lamp in the VOICE MENU lights up, enabling the eight (rhythm) buttons to function as the VOICE MENU. (They normally function as the pattern selectors for Auto Rhythm.) While this lamp is lit, press one of the seven buttons from TROMBONE to PIPE ORGAN. The lamp of the grey button in the VOICE Section you transferred it to flashes to indicate that the sound has been transferred. Please try transferring other voices using this same procedure. Note that if the POWER switch is turned off, the voices transferred to the grey buttons will be returned to their Original Voices (the voices as displayed).

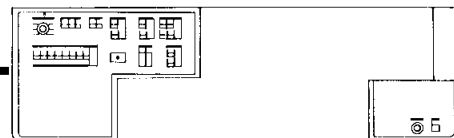

[Checking the Transferred Voices]

When a grey button is pressed, the lamp of the voice transferred to that button will light up, indicating which voice was transferred.

If no voices from the VOICE MENU have been transferred to that location, the ORIGINAL VOICE lamp lights up.

[ORIGINAL VOICE]

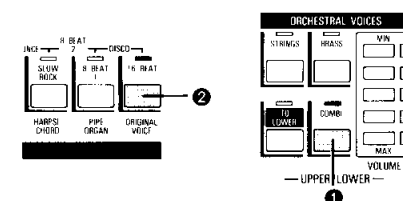

When the ORIGINAL VOICE BUTTON is pressed while depressing the grey button, you can cancel the sound transferred to that button and return to its displayed voice.

[Additional Information]

- The same voice can be transferred to multiple grey buttons.
- When a VOICE MENU sound has been transferred to SOLO or PEDAL VOICES, they automatically become "monophonic" voices, meaning that only one note at a time can be played.

3. Using Sustain

SUSTAIN

This feature permits the sound to gradually fade out after an Upper Keyboard (Orchestral Voices only) and/or a Pedal note is released.

1 Turn on the UPPER button.

2 Select a sound from the Upper/Lower ORCHESTRAL VOICES, then play the upper keyboard.

After releasing the keys, a gradual fade-out is added to the sound. Even when TO LOWER is on and Orchestral Voices are being produced from the lower keyboard, the Sustain effect is active.

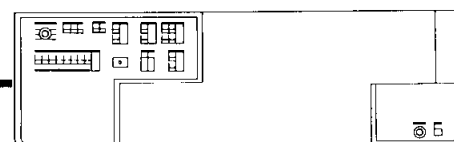
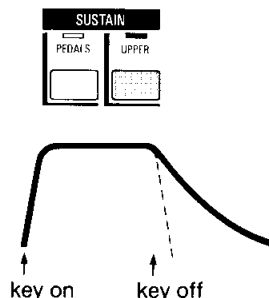

[Sustain Effect for Pedal Keyboard]

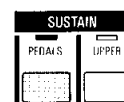

If the PEDALS button is turned on, a gradual fade-out is added to the sound after releasing the keys of the pedal keyboard.

4. Adding Rhythm

AUTO RHYTHM

This effect automatically produces 15 different rhythm patterns consisting of authentic percussion sounds.

1 Select one of the rhythm patterns and set the desired volume level.

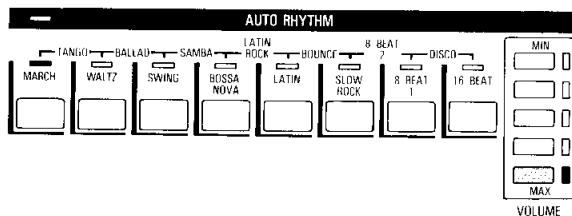

Rhythm Patterns of Lower Row: To choose one of the eight rhythm patterns displayed on the lower row, press the corresponding button of the desired pattern.

Rhythm Patterns of Upper Row: To choose one of the seven patterns (TANGO, BALLAD, SAMBA, etc.) displayed on the top row, simultaneously press the two adjacent buttons below the desired pattern name to turn on both of their indicator lamps. (For example, to choose TANGO, simultaneously press the MARCH and WALTZ buttons.)

2 Adjust the tempo (speed) of the rhythm.

This knob is used to control the speed of the rhythm. The tempo will increase if you turn the knob clockwise and will decrease when you turn it counter-clockwise.

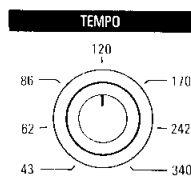

3 Turn the rhythm on.

START button: When this button is turned on, the rhythm will start immediately.

SYNCHRO START button: If you turn this button on, the rhythm will wait and start with you when you play a note on the lower (or pedal) keyboard.

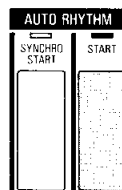

4 Stop the rhythm.

To stop the rhythm, press the START (or SYNCHRO START) button that has been set to its ON position, a second time to turn it off.

[Setting up the pre-programmed registrations]

You can automatically set up a pre-programmed registration suitable to each rhythm pattern. Before pressing the POWER On switch, hold the button(s) corresponding to the rhythm you want registered.



[TEMPO lamp]

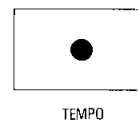

Once the rhythm has been activated, this lamp will flash at the first beat (downbeat) of each measure. In addition, when Synchro Start is in use, this lamp will act as a silent visual metronome, indicating the exact tempo until the rhythm is started.

[Numerals on TEMPO knob]

The numbers printed around the tempo knob indicate the approximate number of beats per minute.

Please refer to these values as a "yardstick" for setting the speed of the rhythm.

[Additional Information]

- When the rhythm is started, one measure of a rhythmic variation pattern is automatically added every four measures. When RHYTHMIC of the lower keyboard is used together with AUTO BASS CHORD, the chord pattern will also change every four measures.
- Because the use of Synchro Start enables the rhythm and accompaniment to be started at the same time, it is very convenient when playing accompaniment using Auto Bass Chord. (See page 10 for details.)

5. Having Fun With Automatic Accompaniment

AUTO BASS CHORD

This function automatically produces chord and bass accompaniment. It can be used as either Single Finger or Fingered Chord accompaniment, providing playing enjoyment for everyone from beginning to advanced players.

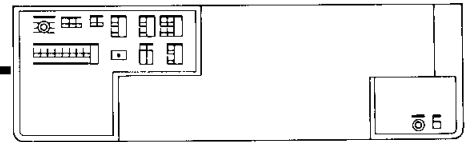

[Automatic Accompaniment with the Touch of a Finger: SINGLE FINGER]

1 Turn on the SINGLE FINGER button.

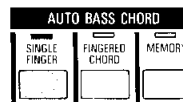

2 For chord accompaniment, press the COMBI. (RHYTHMIC) button of the Lower ORCHES./RHYTHMIC section, then set the volume level. (See page 7.)

While using Auto Bass Chord (or Auto Rhythm), this COMBI. (RHYTHMIC) button provides rhythmic accompaniment using a piano voice.

Also, if voices from the VOICE MENU (for example, Jazz Guitar, Acoustic Guitar, etc.) are transferred to this button, these sounds will automatically be strummed. (See page 8.)

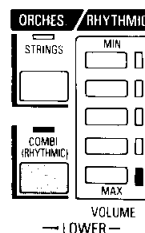

3 For the bass accompaniment, choose a sound from PEDAL VOICES, then set the volume level. (See page 7.)

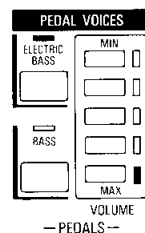

4 Select a rhythm. (See Page 9)

Once you've chosen a rhythm pattern, adjust the tempo to a speed comfortable for you. Then set your desired volume level and turn on SYNCHRO START.

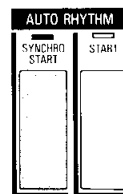

5 Hold a key on the lower keyboard.

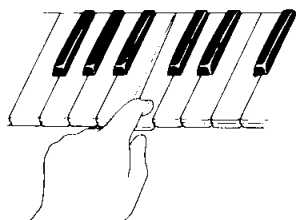

[Relationship between the lower keyboard notes and corresponding major chords]

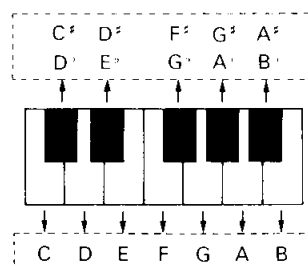

You will now hear a major chord and bass accompaniment in synchronization with the rhythm.

The note you have played is called the "root". A chord derives its name from its root, such as C major, F major, etc.

[Let's try playing other chords]

Minor chords: Simultaneously press the root (name) as well as any black key to the left of it. (Example: Am)



Seventh chords: Simultaneously press the root (name) as well as any white key to left of it. (Example: G7)



Minor seventh chords: Simultaneously press the root (name) as well as any black key and any white key to the left of it. (Example: Gm7)

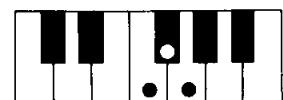

[Chord Accompaniment without strumming]

The STRINGS button (of the Lower ORCHES./RHYTHMIC section) permits a sustained non-strumming chord accompaniment.

Also, if both COMBI. (RHYTHMIC) (from the Lower ORCHES./RHYTHMIC section) and TO LOWER (from the Upper/Lower ORCHESTRAL VOICES section) are turned on, you will obtain both rhythmic and sustained chord accompaniment.

[Additional Information]

- With Single Finger, the chord produced will sound in the same octave regardless of where it is played on the lower keyboard.
- When you want to change chords, please lift your fingers completely from the lower keyboard for a moment before pressing the next key.

[MEMORY]

This feature allows the chord and bass accompaniment to continue even after you have lifted your fingers from the lower keyboard.

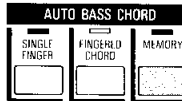

[Automatic Accompaniment by Playing Your Own Chord: FINGERED CHORD]

1 Turn on the FINGERED CHORD button.

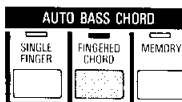

2 For the chord accompaniment, turn on the COMBI. (RHYTHMIC) button (of the Lower ORCHES./RHYTHMIC section) then set the volume level. (See page 7.)

This button provides rhythmic accompaniment with a piano voice. Voices transferred from the VOICE MENU will also be strummed. (See page 8.)

3 For the bass accompaniment voice, choose a sound from PEDAL VOICES, then set the volume level. (See page 7.)

4 Select a rhythm. (See page 9.)

Once you've chosen a rhythm pattern, adjust the tempo to a comfortable speed and volume. If you use SYNCHRO START, the automatic accompaniment and rhythm will start when you play a chord on the lower keyboard.

5 Hold a chord on the lower keyboard.

You will now hear a chord and bass accompaniment in synchronization with the rhythm. The chord you play forms the basis for the automatic accompaniment. You can also add Memory, if you like.

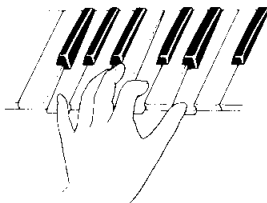

[Example of Fingered Chords]

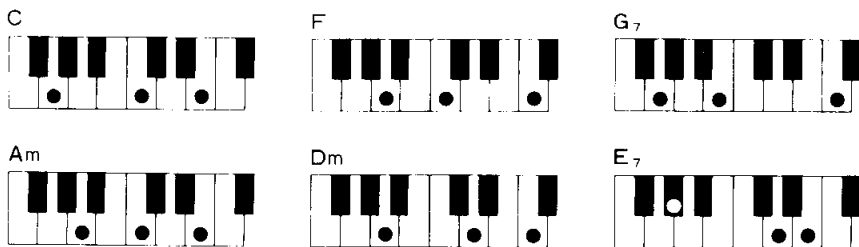

With Fingered Chord, a variety of other chords becomes available to you, above and beyond the four basic types obtainable with Single Finger.

Your Electone will automatically play the proper bass accompaniment to whatever chord you play.

[Memory Can be Used Even When SINGLE FINGER or FINGERED CHORD are Off]

Memory is linked with the auto rhythm and therefore will operate only if the rhythm is on (whether or not Auto Bass Chord is in use).

[Chords Detected by FINGERED CHORD]

The chords available in the Fingered Chord are the following: major, minor, 7th, minor 7th, major 7th, dim, aug, aug7, sus4, 7sus4, 6th min7-5, major-5.

[Additional Information]

- When Auto Bass Chord is used without the auto rhythm, your Electone will still provide the chords and bass, but the background will be stationary (not "animated").
- When producing a seventh-chord using SINGLE FINGER or FINGERED CHORD, the chord and bass patterns are automatically changed.

ACCESSORY JACKS AND OPTIONAL ITEMS

● HEADPHONES Jack

This jack is used to connect headphones (optional). When headphones are connected, there will be no sound from the Electone's speakers. This allows you to play your Electone at any time without disturbing others.

IMPORTANT: Do not use this jack for any purpose other than headphones!



● AUX. OUT Jack

This jack is used to produce a more powerful sound by connecting an external amplifier or other devices. If this jack is connected to the LINE IN jack of a tape recorder, direct recording is also possible. (Nominal Impedance: 470Ω)



● EXP. IN Jack

This jack accepts a monaural signal from a synthesizer or similar accessory. The volume of the equipment connected here will be controlled by the Electone Expression Pedal.



● MIDI IN/OUT Jacks

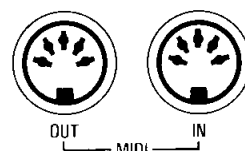

The MIDI (Musical Instrument Digital Interface) terminals conform to the MIDI standard for digital electronic instruments. These jacks enable you to connect your Electone to a computer or other MIDI compatible electronic instruments for data communication.

WARNING: The connection or disconnection of any accessory, (other than headphones) while the Electone is ON, can result in extensive damage to the Electone and/or the accessory. Damage caused by the improper connection/disconnection of accessories is not covered by the manufacturer's warranty.

■ OPTIONAL ITEMS

● Keyboard Amplifier (KA-10)

If you wish to enjoy a more powerful sound, please purchase the exclusive Keyboard Amplifier KA-10. When using the KA-10, connect the ME Electone AUX. OUT jack and the KA-10 AUX. IN jack. Then install by hanging it under the steel rail between the side boards.

ELECTROMAGNETIC INTERFERENCE

"Interference" can be a two way street; something you are operating can interfere with others or, something someone else has may interfere with something of yours.

Naturally, it is also possible that two or more of your own electronic (electric) devices may interfere with each other. Your Electone has been designed to minimize all these possibilities and meets all applicable standards worldwide.

Electromagnetic interference with your Electone can show itself in a variety of ways. You may hear speech, music, "beeps", static, or buzzing sounds. Yamaha Electones are designed to reject RF (radio frequency) signals that are many times the levels found in any normal environment. If, however, you are in the immediate proximity of a very high power transmitter, some interference may still occur. If this should happen, please try to identify the radio (TV) station and record the time of day that the interference occurs. Station identification is essential in order that the offending frequencies can be established and the authorized (legal) operating power level of the transmitter causing the interference can be verified. If the interference continues, please follow the corrective measure suggestions provided later in this section.

If the interference is in the form of occasional buzzing or static, it is highly probable that the cause can be traced to the turning on or off of some household appliance. The offending appliance can also be outside your own residence. Usually a "time" pattern

(i.e., evenings only, etc.) will be involved. Noises of this type rarely originate in the Electone itself. If the condition continues, please contact your local authorized Yamaha Electone dealer for assistance.

Main power line disturbances and electrical storms (lightning) can also be the source of static interference. Generally speaking, problems generated by these two sources will also be present in your other audio or video equipment. Lightning can also be very destructive. The following special warning also applies to virtually all electronic products.

IMPORTANT NOTICE

Modern electronic products, (i.e., computers, video games, electronic organs, etc.), contain components that, under normal conditions, extend the service free life of the products they make up an almost unbelievable period of time. This is especially true when you consider the vast number of equivalent components incorporated within one given part. These "parts," called "integrated circuits," are however, subject to destruction by high voltage discharges, such as a close proximity lightning strike. This can occur even if the unit is turned off.

IN PERIODS OF ELECTRICAL STORM PROBABILITY, IT IS ADVISABLE THAT YOU DISCONNECT ANY ELECTRONIC DEVICE NOT ACTUALLY IN USE, FROM ITS WALL SOCKET.

TROUBLESHOOTING

Phenomenon	Cause and Solution
Only one sound is heard when two notes are simultaneously played on either the pedal keyboard, or when SOLO Voices are used by themselves.	For practical performance reasons, this Electone has been designed so that only one note can be played at a time on the pedal keyboard or with the SOLO Voices. (See page 6-7.)
If over 10 notes in total are simultaneously pressed on both the upper and lower keyboards, some notes are not produced.	With this Electone, a maximum of 10 notes can be produced simultaneously in any upper and lower keyboards ratio. (See page 6.)
Voices from each keyboard have been selected and keys are pressed, but no sound is produced.	First check the MASTER VOLUME and EXPRESSION PEDAL, then check if the volume levels of the desired VOICE sections are not set to MIN. If you wish to produce sound from the pedal keyboard, turn off SINGLE FINGER and FINGERED CHORD in the AUTO BASS CHORD section. (See page 5 to 7.)
The rhythm is started, but COMBI. (RHYTHMIC) does not synchronize with the rhythm.	The COMBI. (RHYTHMIC) button will not be synchronized with the rhythm unless AUTO BASS CHORD is turned on. (See page 7.)
When a "grey" button is pressed, a sound different than that displayed is produced.	This is because a voice had been transferred to that position from the VOICE MENU. To restore the displayed voice, either turn the POWER switch off, then on again, or press the ORIGINAL VOICE button while depressing that grey button. (See page 8.)
When using the Single Finger function, the chord does not change even when you press different keys.	When the lower keyboard is played legato style the chords may not change properly even though you are pressing different keys. You must lift your fingers completely from the keyboard when changing chords. (See page 10.)
When you lift your hand off the lower keyboard, the rhythm, lower keyboard and pedal sounds stop.	When the Synchro Start function is used, the rhythm stops when the lower keyboard is not being played. If you want the sounds to continue, turn on the Auto Bass Chord MEMORY feature. (See page 11.)

SPECIFICATIONS

KEYBOARD	UPPER : 44KEYS (f-c4), LOWER : 44 KEYS (F-c3), PEDALS : 13 KEYS (C-c)
UPPER/LOWER ORCHESTRAL VOICES	STRINGS, BRASS, COMBI., TO LOWER, VOLUME
UPPER SOLO VOICES	FLUTE, TRUMPET, VOLUME
LOWER ORCHES./RHYTHMIC	STRINGS, COMBI. (RHYTHMIC), VOLUME
PEDAL VOICES	ELECTRIC BASS, BASS, VOLUME
VOICE MENU	TROMBONE, SAXOPHONE, PIANO, JAZZ GUITAR, ACOUSTIC GUITAR, HARPSICHORD, PIPE ORGAN, ORIGINAL VOICE
SUSTAIN	UPPER, PEDALS
AUTO RHYTHM	PATTERNS MARCH, TANGO, WALTZ, BALLAD, SWING, SAMBA, BOSSANOVA, LATIN ROCK, LATIN, BOUNCE, SLOW ROCK, 8 BEAT 1•2, DISCO, 16 BEAT
AUTO BASS CHORD	CONTROLS VOLUME, START, SYNCHRO START, TEMPO, TEMPO LAMP
MAIN CONTROLS	SINGLE FINGER, FINGERED CHORD, MEMORY
ACCESSORY JACKS	MASTER VOLUME, EXPRESSION PEDAL, POWER
AMPLIFIER	HEADPHONES, AUX. OUT, EXP. IN, MIDI IN-OUT
SPEAKER	20W
DIMENSIONS	10cm
WEIGHT	106.2(W)×39.2(D)×84.6(H) cm (41 ³ / ₄ " × 15 ¹ / ₂ " × 33 ¹ / ₃ ") 28.5 kg (62.2 lbs.)

*Specifications subject to change without notice.

MIDI Implementation Chart

Date: 10/24, 1985
Version: 1.0

Function . . .		Transmitted	Recognized	Remarks
Basic Channel	Default	1 2 3	1 2 3 16	UK (PRESET) LK (PRESET) PK (PRESET) CONTROL (PRESET)
	Changes	×	×	
Mode	Default	Mode 3	Mode 3	
	Messages	×	×	
	Altered	*****	×	
Note Number		53-96 41-84 36-48	53-96 41-84 36-48	UK LK PK
	True Voice	*****	53-96, 41-84, 36-48	UK, LK, PK
Velocity	Note ON	× 9nH, v = 64	× 9nH, v = 1-127	
	Note OFF	× 9nH, v = 0	× 9nH, v = 0, 8nH	
After Touch	Key's	×	×	
	Ch's	×	×	
Pitch Bender		×	×	
Control Change		×	×	
Program Change		×	×	
	True #	*****	×	
System Exclusive		×	×	
System Common	Song Pos	×	×	
	Song Sel	×	×	
	Tune	×	×	
System Real Time	Clock	○	○	*
	Commands	○	○	(FA, FC)
Aux Messages	Local ON/OFF	×	×	
	All Notes OFF	×	○	** (123)
	Active Sense	○	○	
	Reset	×	○	
Notes		* Recognize only when External Mode ** Recognize only channel 16		

Mode 1: OMNI ON, POLY
Mode 3: OMNI OFF, POLY

Mode 2: OMNI ON, MONO
Mode 4: OMNI OFF, MONO

○: Yes
×: No

SINCE 1887  **YAMAHA**
NIPPON GAKKI CO., LTD. HAMAMATSU, JAPAN
ELECTONE is a registered trademark of Nippon Gakki Co., Ltd.