

YAMAHA *Clavinova*®

CVP-55 CVP-65

Owner's Guide Bedienungsanleitung Manuel d'instructions Manual del Propietario

IMPORTANT

Check Your Power Supply

Make sure that your local AC mains voltage matches the voltage specified on the name plate on the bottom panel. In some areas a voltage selector may be provided on the bottom panel of the main keyboard unit near the power cord. Make sure that the voltage selector is set for the voltage in your area.

WICHTIG

Netzspannung überprüfen

Sicherstellen, daß die örtliche Netzspannung den Betriebsspannungswerten entspricht, die in die Plakette auf der Unterseite des Keyboards eingetragen sind. Für manche Bestimmungsländer ist das Keyboard mit einem Spannungswähler auf der Rückseite ausgerüstet. Darauf achten, daß der Spannungswähler auf die örtliche Netzspannung eingestellt ist.

IMPORTANT

Vérifier la source d'alimentation

Vérifier que la tension spécifiée sur le panneau arrière correspond à la tension du secteur. Dans certaines régions, l'instrument peut être équipé d'un sélecteur de tension situé sur le panneau inférieur du clavier à proximité du cordon d'alimentation. Vérifier que ce sélecteur est bien réglé en fonction de la tension secteur de la région.

IMPORTANTE

Compruebe la alimentación de su área

Asegúrese de que la tensión de CA local corresponde con la tensión especificada en la placa del panel inferior. En algunos lugares, se incorpora un selector de tensión en el panel inferior de la unidad del teclado principal, cerca del cable de alimentación. Asegúrese de que este selector de tensión esté ajustado para la tensión de su área.

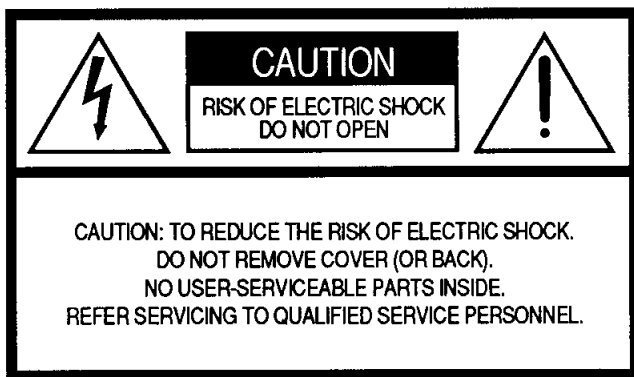

See bottom of Keyboard enclosure for graphic symbol markings

The lightning flash with arrowhead symbol, within an equilateral triangle, is intended to alert the user to the presence of uninsulated "dangerous voltage" within the product's enclosure that may be of sufficient magnitude to constitute a risk of electric shock to persons.

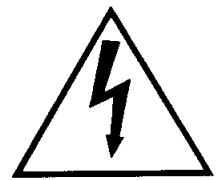

The exclamation point within an equilateral triangle is intended to alert the user to the presence of important operating and maintenance (servicing) instructions in the literature accompanying the product.



IMPORTANT SAFETY AND INSTALLATION INSTRUCTIONS

INFORMATION RELATING TO POSSIBLE PERSONAL INJURY, ELECTRIC SHOCK, AND FIRE HAZARD POSSIBILITIES HAS BEEN INCLUDED IN THIS LIST.

WARNING -When using electronic products, basic precautions should always be followed, including the following:

1. Read all Safety and Installation Instructions, Explanation of Graphical Symbols, and assembly instructions (where applicable) BEFORE using your Yamaha electronic product. Check unit weight specifications before you attempt to move this instrument!
2. Main Power Supply Verification: Your Yamaha electronic product has been manufactured specifically for the main supply voltage used in your area. If you should move, or if any doubt exists, please contact your dealer for instructions. The main supply voltage required by your electronic product is printed on the name plate. For name plate location, see "PREPARATION" item.
3. This product may be equipped with a polarized line plug (one blade wider than the other). If you are unable to insert the plug into the outlet, contact an electrician to have your obsolete outlet replaced. Do NOT defeat the safety purpose of the plug. Yamaha products not having polarized plugs incorporate construction methods and designs that do not require line plug polarization.
4. **WARNING**-Do NOT place objects on your electronic product's power cord or place the unit in a position where anyone could trip over, walk over, or roll anything over cords of any kind. Do NOT allow your electronic product or its bench to rest on or be installed over cords of any type. Improper installations of this type create the possibility of a fire hazard and/or personal injury.
5. Environment: Your electronic product should be installed away from heat sources such as a radiator, heat registers and/or other products that produce heat. Additionally, the unit should not be located in a position that exposes the cabinet to direct sunlight, or air currents having high humidity or heat levels.
6. Your Yamaha electronic product should be placed so that its location or position does not interfere with its proper ventilation.
7. Some Yamaha electronic products may have benches that are either a part of the product or supplied as an optional accessory. Some of these benches are designed to be dealer assembled. Please make sure that the bench is stable before using it. The bench supplied by Yamaha was designed for seating only. No other uses are recommended.
8. Some Yamaha electronic products can be made to operate with or without the side panels or other components that constitute a stand. These products should be used only with the components supplied or a cart or stand that is recommended by the manufacturer.
9. Do not operate for a long period of time at a high volume level or at a level that is uncomfortable. If you experience any hearing loss or ringing in the ears, you should consult an audiologist.
10. Do not use your Yamaha electronic product near water or in wet environments. For example, near a swimming pool, spa, or in a wet basement.
11. Care should be taken so that objects do not fall, and liquids are not spilled, into the enclosure through openings.
12. Your Yamaha electronic product should be serviced by a qualified service person when:
 - a. The power-supply cord or plug has been damaged: or
 - b. Objects have fallen, or liquid has been spilled into the product: or
 - c. The product has been exposed to rain: or
 - d. The product does not operate, exhibits a marked change in performance: or
 - e. The product has been dropped, or the enclosure of the product has been damaged.
13. When not in use, always turn your Yamaha electronic product "OFF". The power-supply cord of the product should be unplugged from the outlet when it is to be left unused for a long period of time. Notes: In this case, some units may lose some user programmed data. Factory programmed memories will not be affected.
14. Do not attempt to service the product beyond that described in the user-maintenance instructions. All other servicing should be referred to qualified service personnel.
15. Electromagnetic Interference (RFI). This series of Yamaha electronic products utilizes digital (high frequency pulse) technology that may adversely affect Radio/TV reception or the operation of other devices that utilize digital technology. Please read FCC Information (page 160) for additional information.

PLEASE KEEP THIS MANUAL
FOR FUTURE REFERENCE!

Clavinova CVP-55 CVP-65 Quick Operation Guide

■ Voice List

Panel Voices	Voices 13-53			
PIANO	13 BRASS	24 HARMONICA	35 PIANO SOFT	46 BANJO
CLAVINOVA TONE	14 POP BRASS	25 STRINGS SOFT	36 E.PIANO DX	47 PIZZICATO
E.PIANO	15 TRUMPET	26 VIOLIN	37 SYNTH CRYSTAL	48 HARP
HARPSICHORD	16 MUTE TRUMPET	27 VIOLIN HARD	38 CELESTA	49 UPRIGHT BASS SOFT
VIBES	17 HORN	28 FULL ORGAN	39 MARIMBA	50 ELEC BASS SOFT
GIUITAR	18 SAXOPHONE	29 JAZZ ORGAN	40 FOLK GUITAR	51 ELEC BASS HEAVY
STRINGS	19 SAXOPHONE SOFT	30 SYNTH BRASS	41 JAZZ GUITAR 1	52 SYNTH BASS
ORGAN	20 CLARINET	31 SYNTH WOOD	42 JAZZ GUITAR 2	53 TIMPANI
CHOIR	21 OBOE	32 SYNTH STRINGS	43 ROCK GUITAR 1	
UPRIGHT BASS	22 FLUTE	33 SYNTH CHOIR	44 ROCK GUITAR 2	
ELEC BASS	23 ACCORDION	34 PIANO BRIGHT	45 MUTE GUITAR	
DRUMS				

■ Style List

Panel Styles	Disk Styles (CVP-65)					
POP 1	SLOW ROCK	BOSSA	1 AMERICAN POP	11 BLUES SHUFFLE	21 REGGAE	31 NEW AGE
POP 2	SHUFFLE	SAMBA	2 60'S	12 CONTEMPORARY	22 LATIN POP	32 COUNTRY SHUFFLE
DANCE POP 1	COUNTRY 1	CHA-CHA	3 SOUL ROCK	13 DIXIE	23 LATIN ROCK	33 FOLKLORE
DANCE POP 2	COUNTRY 2	RHUMBA	4 16 BEAT	14 RAGTIME	24 CHA-CHA	34 JAPANESE POP 1
16 BEAT 1	SWING 1	MARCH	5 ROCK BALLAD	15 TANGO 1	25 WALTZ	35 JAPANESE POP 2
16 BEAT 2	SWING 2	MARCH 6/8	6 COUNTRY ROCK	16 TANGO 2	26 VIENNESE WALTZ	36 JAPANESE POP 3
ROCK'N'	BIG BAND	WALTZ	7 PIANO BALLAD	17 LAMBADA	27 CHANSON	37 JAPANESE POP 4
16 BEAT 3	BOOGIE	J.WALTZ	8 SOLO PIANO	18 SAMBA	28 POLKA	38 ENKA 1
			9 RHYTHM & BLUES	19 BOSSA 1	29 HAWAIIAN	39 ENKA 2
			10 GOSPEL	20 BOSSA 2	30 CALYPSO	40 ONDO

■ Quick Operation Guide

Function		Hold	+	Press	Manual Page			
					Eng.	Ger.	Fre.	Spa.
Select Voice 13-53		[VOICE 13-53] [DRUMS]		+ TEMPO [▲]/[▼] or + Voice 10 Key	13	49	85	121
Transpose	Up	[MIDI/TRANPOSE]		+ TEMPO [▲]	18	54	90	126
	Down	[MIDI/TRANPOSE]		+ TEMPO [▼]				
Pitch Control	Up	[A-1, B-1] keys		+ [C3 ~ B3] key	18	54	90	126
	Down	[A-1, A#-1] keys		+ [C3 ~ B3] key				
	Normal	[A-1, A#-1, B-1] keys		+ [C3 ~ B3] key				
Touch Sensitivity	Hard	[MIDI/TRANPOSE]		+ [POP 1]	18	54	90	126
	Medium	[MIDI/TRANPOSE]		+ [DANCE POP 1]				
	Soft	[MIDI/TRANPOSE]		+ [16 BEAT 1]				
Reverb Depth		[REVERB]		+ TEMPO [▲]/[▼]	16	52	88	124
Split Point	Voice Split	[SPLIT]		+ Desired Key	15	51	87	123
	ABC Split	[SINGLE FINGER] or [FINGERED]		+ Desired Key	22	58	94	130
Dual/Split Volume Balance	Lowest-numbered voice Up Left voice Up	[SPLIT]		+ TEMPO [▼]	15, 16	51, 52	87, 88	123, 124
	Highest-numbered voice Up Right voice Up	[SPLIT]		+ TEMPO [▲]				
Keyboard Volume		[MIDI/TRANPOSE]		+ BASS Volume	12	48	84	120
Vibrato/Pitch Bend/Expression		[MIDI/TRANPOSE]		+ [MARCH]	12	48	84	120
		Vibrato Bend Up Bend Down Expression	RHYTHM Volume CHORD 1 Volume CHORD 2 Volume BASS Volume					

CVP-55/65 Quick Operation Guide

How to use the Disk Orchestra System

Listening to the Automatic Performance

Manual Page Eng. 25 Ger. 61 Fre. 97 Spa. 133

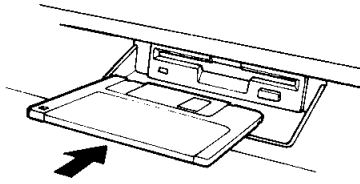

Insert the "Disk Orchestra Collection" disk.

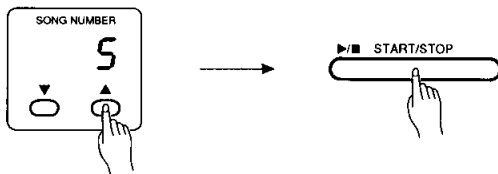

Select a song.

● All songs repeat

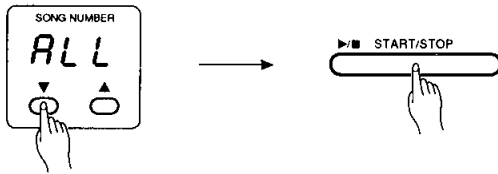

Select "ALL".

● Sequential repeat playback

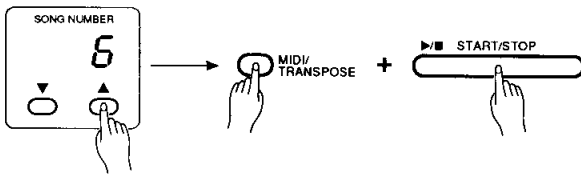

Select a song.

Playing Back only Specific Parts

Manual Page Eng. 25 Ger. 61 Fre. 97 Spa. 133

- LEFT ON Left-hand part ON (LED lights) or OFF
- RIGHT ON Right-hand part ON (LED lights) or OFF
- ORCH ON Orchestra part ON (LED lights) or OFF

Volume Control

Manual Page Eng. 25 Ger. 61 Fre. 97 Spa. 133

- RHYTHM MIN | MAX Drum and Percussion parts
- CHORD 1 MIN | MAX Other backing parts except Bass
- CHORD 2 MIN | MAX Main left- and right-hand parts
- BASS MIN | MAX Bass part

Phrase Repeat

Manual Page Eng. 26 Ger. 62 Fre. 98 Spa. 134

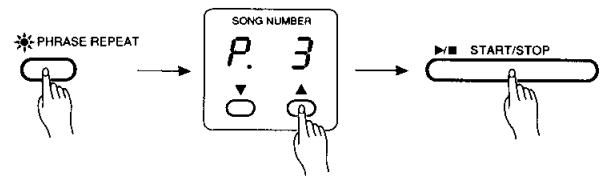

Select the phrase number.

A-B Repeat

Manual Page Eng. 26 Ger. 62 Fre. 98 Spa. 134

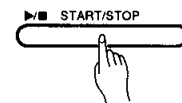

Start playback

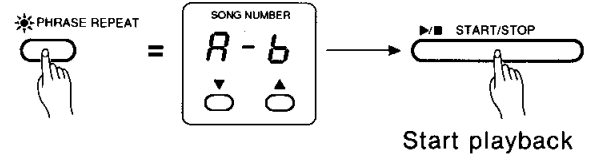
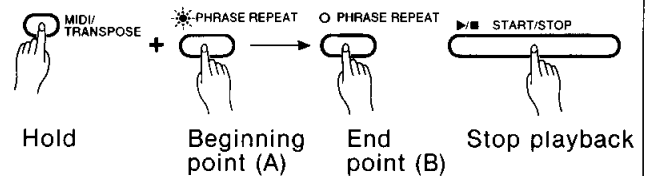

Start playback

Guide Function (CVP-65 only)

Manual Page Eng. 26 Ger. 62 Fre. 98 Spa. 134

After turning [GUIDE] ON

Left- and right-hand guide = LEFT ON RIGHT ON

Right-hand guide only = LEFT ON RIGHT ON

Left-hand guide only = LEFT ON RIGHT ON

● Guide Modes

Normal Wait (default) + A-1 Key

Delayed Wait + B-1 Key

YAMAHA

Introduction

Thank you for choosing a Yamaha CVP-55/CVP-65 Clavinova. Your Clavinova is a fine musical instrument that employs advanced Yamaha music technology. With the proper care, your Clavinova will give you many years of musical pleasure.

- AWM (Advanced Wave Memory) tone generator system offers a range of 53 rich, realistic voices.
- A maximum of 32-note polyphony permits use of sophisticated playing techniques.
- Piano-like touch response — adjustable in 3 stages — provides extensive expressive control and outstanding playability.
- Dual and Split play modes allow 2 voices to be played simultaneously or individually with the left and right hands.
- Unique Clavinova Tone voice provides a fresh sound for new musical expression.

Vorwort

Vielen Dank für den Kauf des Yamaha Clavinova CVP-55/CVP-65. Ihr Clavinova stellt ein hochwertiges Musikinstrument dar, das auf der überlegenen Yamaha Musik-Technologie basiert. Bei angemessener Pflege wird Ihnen Ihr Clavinova über viele Jahre ungetrübten Spielgenuss bieten.

- Das überlegene Yamaha AWM-Tonerzeugungssystem, das mit gespeicherten digitalen Wellensamples arbeitet, bietet 53 realistische, natürlich klingende Instrumentstimmen.
- Eine Polyphonie von maximal 32 simultanen Noten erlaubt auch komplizierteste Spieltechniken.
- Die klavierähnliche Anschlagsdynamik, in 3 Stufen auf die Spieltechnik abstimmbare, ermöglicht feinste Nuancierung des musikalischen Ausdrucks und gewährt eine natürliche Anschlagsansprechung.
- Mit der Dual-Funktion können Sie zwei Stimmen gleichzeitig über die ganze Klaviatur legen, während die als Split-Funktion bezeichnete Manuarteilung linker und rechter Hand verschiedene Stimmen zuweist.

Introduction

Nous vous remercions d'avoir porté votre choix sur le Clavinova Yamaha CVP-55/CVP-65. Le Clavinova est un instrument de musique perfectionné faisant appel aux innovations les plus récentes de la technologie musicale mise au point par Yamaha. Si vous utilisez votre Clavinova avec le soin qui convient, il vous donnera de grandes satisfactions pendant de longues années.

- Le système générateur de sons AWM (de l'anglais Advanced Wave Memory) vous offre 53 sonorités riches, d'un réalisme étonnant.
- La polyphonie maximale à 32 notes permet d'utiliser des techniques d'exécution extrêmement complexes.
- Une réponse au toucher similaire à celle d'un piano (réglable sur 3 niveaux) vous permet un plus grand contrôle de l'expression et vous offre des possibilités d'exécution extraordinaires.
- Les modes d'exécution "DUAL" et "SPLIT" permettent de jouer deux voix simultanément ou individuellement de la main droite et de la main gauche.

Introducción

Gracias por su elección de la Yamaha Clavinova CVP-55/CVP-65. Su Clavinova es un instrumento musical de calidad que emplea la avanzada tecnología musical de Yamaha. Con un trato adecuado, le brindará muchos años de satisfacciones musicales.

- El sistema generador de tonos AWM (Memoria Avanzada de Onda) de Yamaha ofrece un margen de 53 ricas y realísticas voces.
- La polifonía máxima de 32 notas permite el uso de las más avanzadas técnicas de interpretación.
- Una respuesta al toque similar a la del piano, ajustable en 3 etapas, brinda amplio control expresivo y notable facilidad de interpretación.
- Los modos dual y de división permiten interpretar simultánea o individualmente 2 voces con las manos izquierda y derecha.
- La voz de tono exclusiva de las Clavinovas, ofrece un sonido nuevo para una nueva expresión musical.

- 24 exciting accompaniment styles can be used to provide fully-orchestrated rhythm, bass, and chord accompaniment.
- Solo Styleplay makes it simple to produce rich, complex harmonies.
- 10-track performance memory records and plays back your keyboard performances.
- Internal 3.5" floppy disk drive provides extended Performance Memory capacity and Disk Orchestra playback capability.
- MIDI compatibility and a range of MIDI functions make the Clavinova useful in a range of advanced MIDI music systems.

In order to make the most of your Clavinova's performance potential and features, we urge you to read this Owner's Manual thoroughly, and keep it in a safe place for later reference.

- Der lebendige Clavinova-Klang sorgt für natürliche Expression.
- 24 mitreißende Rhythmen, die alleine oder aber zusammen mit raffinierten vollautomatischen Begleitorchestern eingesetzt werden können.
- Die SOLO STYLEPLAY erweitert die automatische Begleitung mit Harmoniennoten zu Ihren Solis.
- Ein 10spuriger Performance-Speicher erlaubt das spurweise Einspielen und Wiedergeben von Arrangements.
- Ein 3,5 Zoll Diskettenlaufwerk ermöglicht externe Speicherung von Daten und Wiedergabe von Disketten der DISK ORCHESTRA COLLECTION.
- Dank der MIDI-Kompatibilität und der zahlreichen MIDI-Funktionen läßt sich das Clavinova problemlos in komplexe MIDI-Musiksysteme eingliedern.

Bitte lesen Sie sich diese Anleitung zunächst einmal durch, um sich mit dem riesigen Potential Ihres Clavinovas bekannt zu machen und heben Sie sie zur späteren Bezugnahme an einem sicheren Ort auf.

- La voix CLAVINOVA TONE au son unique vous offre de nouvelles possibilités d'expression.
- 24 styles d'accompagnement peuvent être utilisés pour produire un accompagnement orchestral avec rythme, basse et accords.
- Le mode Solo Styleplay permet de facilement créer des harmonies riches et complexes.
- Une mémoire d'exécution à 10 pistes permet d'enregistrer et de reproduire des exécutions personnelles.
- Un lecteur de disquette de 3,5" intégré augmente la capacité de mémoire et permet l'utilisation de disquettes DISK ORCHESTRA.
- La compatibilité MIDI et toute une série de fonctions MIDI permettent d'utiliser le Clavinova dans des systèmes musicaux MIDI très complexes.

Afin d'obtenir du Clavinova le maximum des possibilités et fonctions qu'il offre, nous vous conseillons de lire attentivement ce manuel d'instructions et de le conserver en lieu sûr pour toute référence future.

- Pueden usarse 24 emocionantes estilos de acompañamiento para proporcionar acompañamiento totalmente orquestado de ritmo, bajo y acordes.
- La interpretación de solos facilita la producción de ricas y complejas armonías.
- La memoria de interpretación de 10 pistas graba y reproduce sus interpretaciones del teclado.
- La unidad de discos flexibles de 3,5 pulgadas interna proporciona una mayor capacidad de memoria de interpretaciones y capacidad de reproducción de discos orquestales.
- Su compatibilidad con el sistema MIDI, y sus variadas funciones MIDI, hacen de la Clavinova un útil componente en cualquier sistema musical MIDI avanzado.

Para aprovechar al máximo el potencial de ejecución y las características de la Clavinova, le aconsejamos que lea atentamente todo este manual de instrucciones, y que lo guarde en un lugar seguro para futuras referencias.

Contents _____

Taking Care of Your Clavinova	4
Nomenclature	4
Quick Feature Guide	6
Connections	11
The Music Stand	11
The Power Switch	11
The Volume Controls	12
Demonstration Playback	13
Voice Selection	13
Dual Mode	15
Split Mode	15
Digital Reverb Effects	16
The Keyboard & Polyphony	17
The Pedals	17
Touch Sensitivity	18
Transposition	18
Pitch Control	18
Rhythm	19
Piano ABC	21
Style Disk (CVP-65 only)	23
Solo Styleplay	24
Disk Orchestra	25
Performance Memory	27
Disk Control	30
MIDI Functions	32
Troubleshooting	36
Options & Expander Modules	36
MIDI Data Format	36
Index	38
Assembly	148
Specifications	152
Fingering Chart	153
MIDI Implementation Chart	158

Inhaltsverzeichnis _____

Vorsichtsmaßnahmen	40
Bedienelemente und Anschlüsse	40
Die CVP-55/65 Kurzanleitung	42
Anschluß	47
Der Notenständer	47
Netzschalter	47
Lautstärkeregler	48
Demo-Wiedergabe	49
Stimmenwahl	49
Dual-Funktion	51
SPLIT-Funktion	51
Digitalhalleffekte	52
Klavatur und Polyphonie	53
Pedalfunktionen	53
Anschlagsansprechung	54
Transponierung	54
Stimmfunktion	54
Rhythmus	55
Piano ABC-Begleitfunktion	57
Stil-Diskette (nur CVP-65)	59
Solo Styleplay-Funktion	60
Disk Orchestra	61
Performance-Speicher	63
Diskettensteuerung	66
MIDI-Funktionen	68
Fehlersuche	72
Sonderzubehör und Expandermodule	72
MIDI-Datenformat	72
Index	74
Montage	148
Technische Daten	152
Akkordliste	153
MIDI-Implementierungstabelle	158

Table des matières

Entretien du Clavinova	76
Nomenclature	76
Résumé des fonctions	78
Connecteurs	83
Pupitre	83
Interrupteur d'alimentation	83
Commandes de volume	84
Reproduction de démonstration	85
Sélection des voix	85
Mode DUAL	87
Mode SPLIT	87
Effets de réverbération numérique	88
Clavier et Polyphonie	89
Pédales	89
Sensibilité au toucher	90
Transposition	90
Réglage de la hauteur	90
Rythme	91
Piano ABC	93
Disquette de styles (CVP-65 uniquement)	95
Solo Styleplay	96
Disk Orchestra	97
Mémoire d'exécution	99
Utilisation des disquettes	102
Fonctions MIDI	104
Dépistage des pannes	108
Options et modules extendeurs	108
Format des données MIDI	108
Index	110
Montage	148
Spécifications	152
Tablature	153
Feuille d'implantation MIDI	158

Indice

Cuidados de su Clavinova	112
Nomenclatura	112
Guía rápida de las características	114
Conexiones	119
Atril	119
Interruptor de alimentación	119
Controles del volumen	120
Reproducción de demostración	121
Selección de voces	121
Modo dual	123
Modo dividido	123
Efectos de reverberación digital	124
Teclado y polifonía	125
Pedales	125
Sensibilidad de pulsación	126
Transposición	126
Control del tono	126
Ritmo	127
Piano ABC	129
Disco de estilo (sólo CVP-65)	131
Interpretación de solos	132
Discos orquestales	133
Memoria de interpretaciones	135
Control del disco	138
Funciones MIDI	140
Localización y reparación de averías	144
Accesorios opcionales y módulos expansores	144
Formato de datos MIDI	144
Índice alfabético	146
Montaje	148
Especificaciones	152
Gráfica de digitación	153
Gráfico de puesta en práctica de MIDI ...	158

Taking Care of Your Clavinova

Your Clavinova will give you years of playing pleasure if you observe the simple rules given below:

1. Avoid Humidity & Heat

Avoid placing the Clavinova in areas that are subject to excessive humidity or heat. Do not leave the instrument near heaters or in a car exposed to direct sunlight, for example.

2. Avoid Dust & Moisture

Avoid locations in which the instrument is likely to be exposed to excessive dust or moisture.

3. Power-off Before Connecting

Connections between the Clavinova and any other device must be made with both pieces of equipment turned off.

4. Handle With Care

Never apply excessive force to the controls, connectors or other parts of your Clavinova, and avoid scratching or bumping it with hard objects. Further, always turn the POWER switch off after use.

5. Clean Carefully

Clean the cabinet and keys of your Clavinova only with a clean, slightly damp cloth. A neutral cleanser may be used if desired. Never use abrasive cleansers, waxes, solvents or chemical dust cloths since these can dull or damage the finish.

6. Never Tamper With the Internal Circuitry

Never open the Clavinova cabinet and touch or tamper with the internal circuitry. Tampering with the circuitry can result in electrical shock!

7. Electric Interference

Since the Clavinova contains digital circuitry, it may cause interference if placed too close to radio or television receivers. If this occurs, move the instrument further away from the affected equipment.

8. Check Your Power Supply

Make sure that your local AC mains voltage matches the voltage specified on the name plate on the bottom panel. In some areas a voltage selector may be provided on the bottom panel of the main keyboard unit near the power cord. Make sure that the voltage selector is set for the voltage in your area.

● Name Plate Location

The nameplate is located on the bottom panel.

Eject Floppy Disks Carefully

To eject a floppy disk, press the eject button slowly as far as it will go then, when the disk is fully ejected, remove it by hand.

The disk may not be ejected properly if the eject button is pressed too quickly, or it is not pressed in as far as it will go (the eject button may get stuck in a half-pressed position and the disk extends from the drive slot by only a few millimeters). If this happens, do not attempt to pull out the partially-ejected disk. Using force in this situation can damage the disk-drive mechanism. To remove a partially ejected disk, try pressing the eject button again, or push the disk back into the slot and then repeat the eject procedure — carefully.

Nomenclature

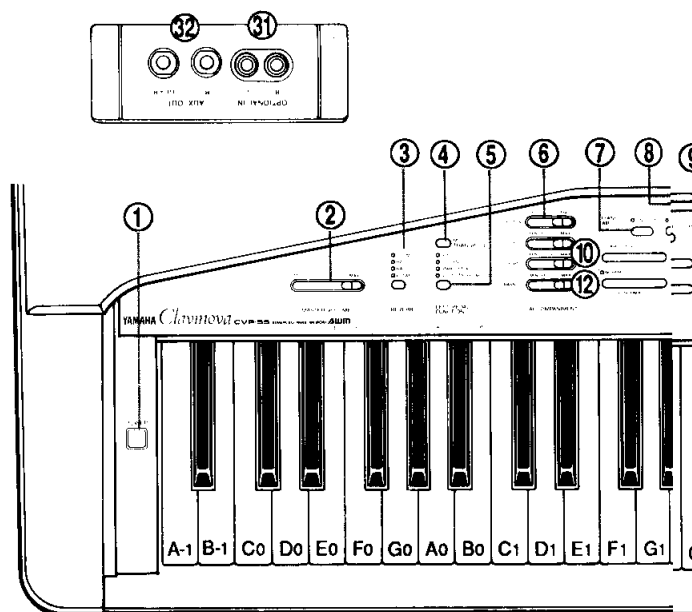

CVP-55

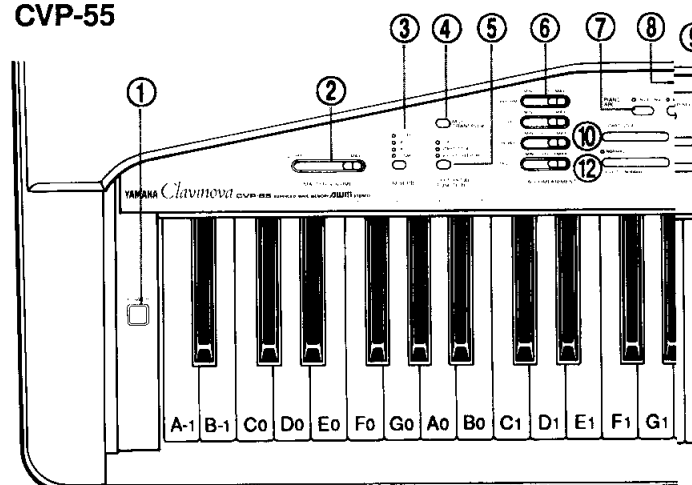

CVP-65

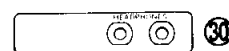

- ① POWER Switchpage 11
- ② MASTER VOLUME Controlpage 12
- ③ [REVERB] Buttonpage 16
- ④ [MIDI/TRANPOSE] Buttonpage 12, 18, 20, 21, 25, 26, 28, 33
- ⑤ [LEFT PEDAL FUNCTION] Buttonpage 17
- ⑥ ACCOMPANIMENT Volume Controlspage 12
- ⑦ PIANO ABC [SINGLE FINGER] Buttonpage 21
- ⑧ PIANO ABC [FINGERED] Buttonpage 21
- ⑨ [SOLO STYLEPLAY] Buttonpage 24
- ⑩ [START/STOP] Buttonpage 19
- ⑪ [INTRO/ENDING] Buttonpage 19
- ⑫ [NORMAL/FILL TO NORMAL] Buttonpage 19
- ⑬ [VARIATION/FILL TO VARIATION] Buttonpage 19
- ⑭ STYLE Selectorspage 19

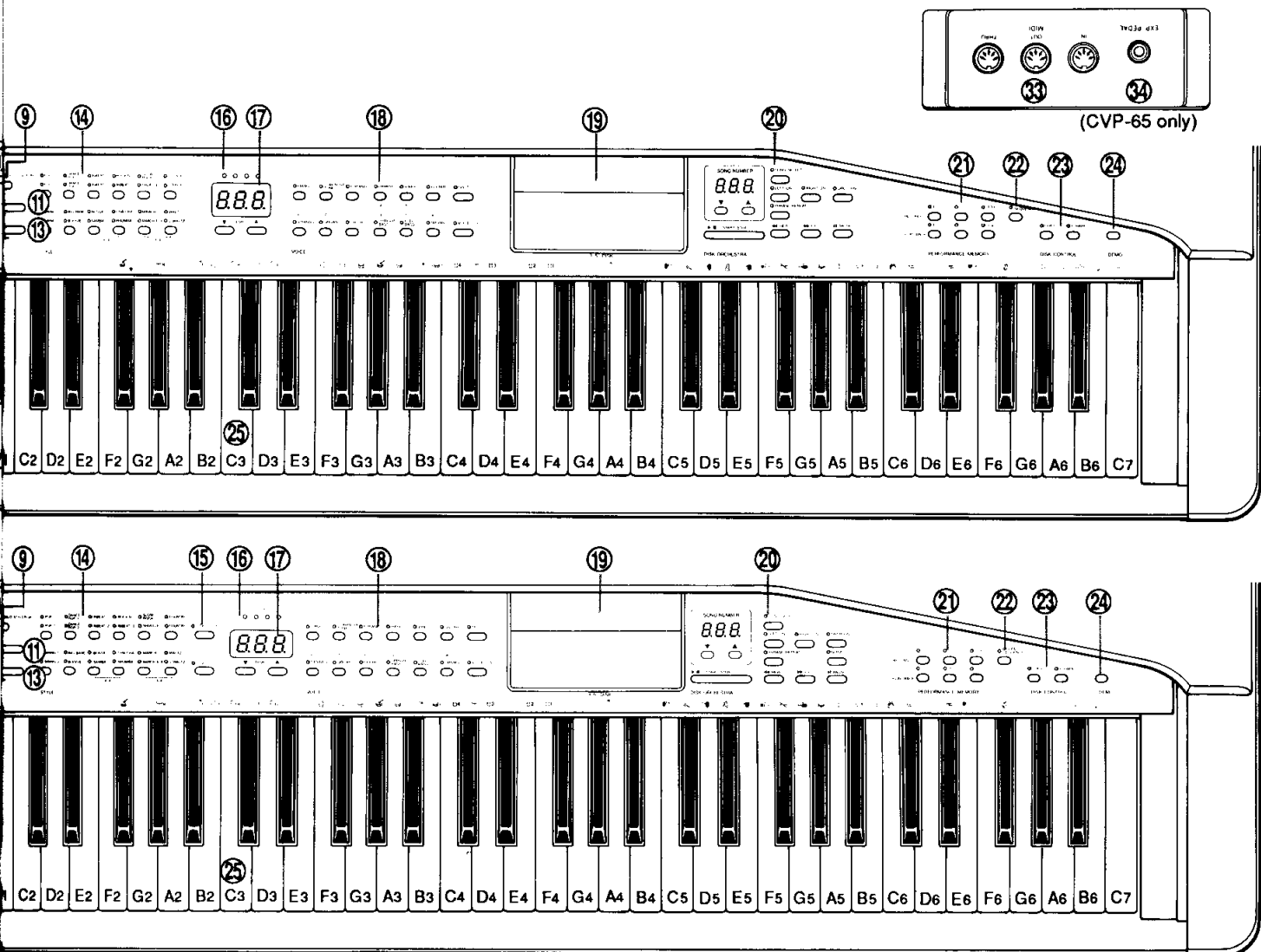

- 15 [DISK STYLE] Buttons (CVP-65 only)page 23
- 16 BEAT Displaypage 20
- 17 TEMPO Display and [▲] and [▼] Buttonspage 19
- 18 VOICE Selectorspage 13
- 19 3.5" Floppy Disk Drivepage 23, 25, 27, 30
- 20 DISK ORCHESTRA Display and Buttonspage 23, 25, 27, 30
- 21 PERFORMANCE MEMORY Buttonspage 27
- 22 [CHORD SEQUENCE] Buttonpage 29
- 23 DISK CONTROL Buttonspage 30
- 24 [DEMO] Buttonpage 13
- 25 Keyboardpage 17
- 26 Keyboard Guide Lamps (CVP-65 only)page 26
- 27 Soft Pedalpage 17
- 28 Sostenuto Pedal (CVP-65 only)page 17
- 29 Damper Pedalpage 17
- 30 HEADPHONES Jackspage 11

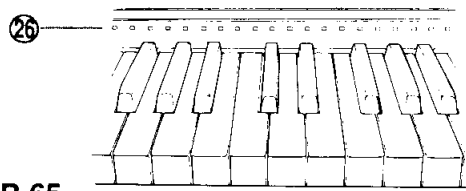

CVP-65

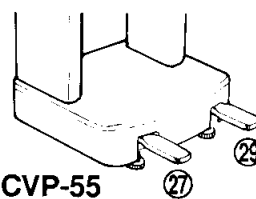

CVP-55

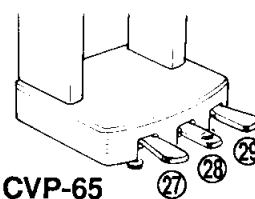

CVP-65

- 31 OPTIONAL IN R and L Jackspage 11
- 32 AUX. OUT R and L/L+R Jackspage 11
- 33 MIDI Connectorspage 11
- 34 EXP. PEDAL Jack (CVP-65 only)page 11

Quick Feature Guide

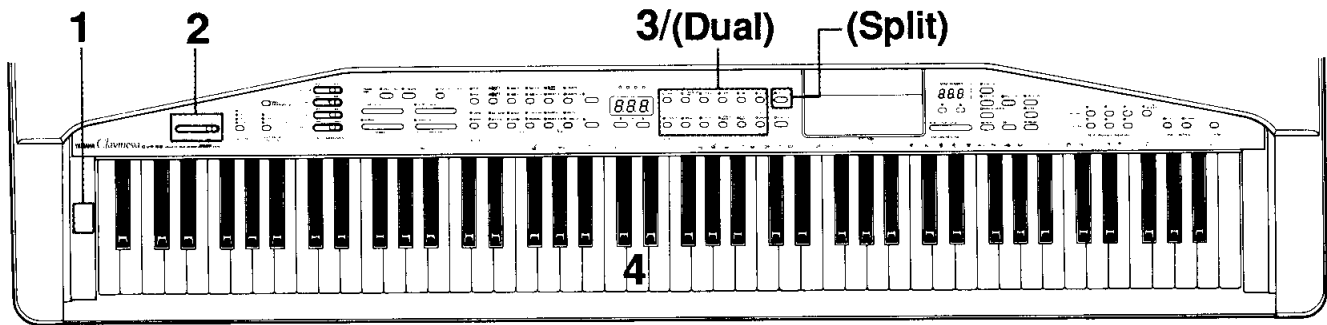

■ Select a Voice & Play

1. Turn the power on [page 11].

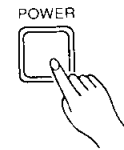

2. Set the MASTER VOLUME control about half way between MIN and MAX [page 12].



3. Press one of the VOICE selectors [page 13].

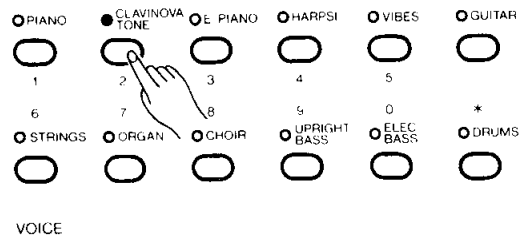

4. Play [page 17].

■ Play 2 Voices at Once (Dual)

Press two voice selectors simultaneously so that both of their indicators light [page 15].

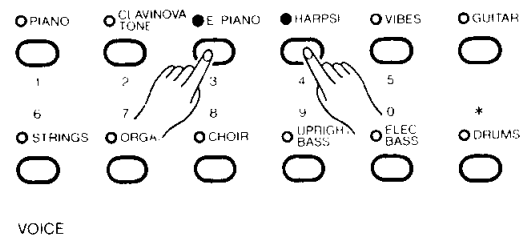

■ Play Different Left- and Right-hand Voices (Split)

Press the [SPLIT] button — UPRIGHT BASS will automatically be assigned to all keys to the left of and including F#2; any selected voice can be played on all keys to the right of F#2 [page 15].

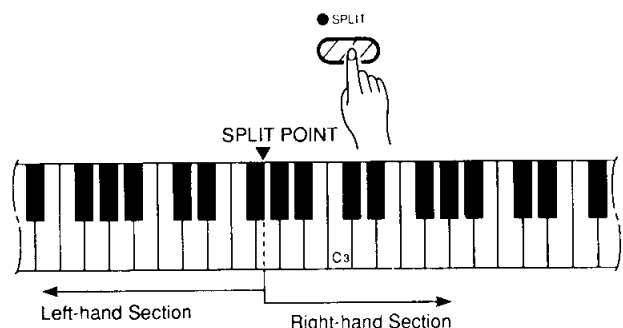

Here's a quick introduction to the features and functions of the CVP-55/CVP-65 that you'll probably use most frequently. Refer to the page numbers in brackets for more detailed information.

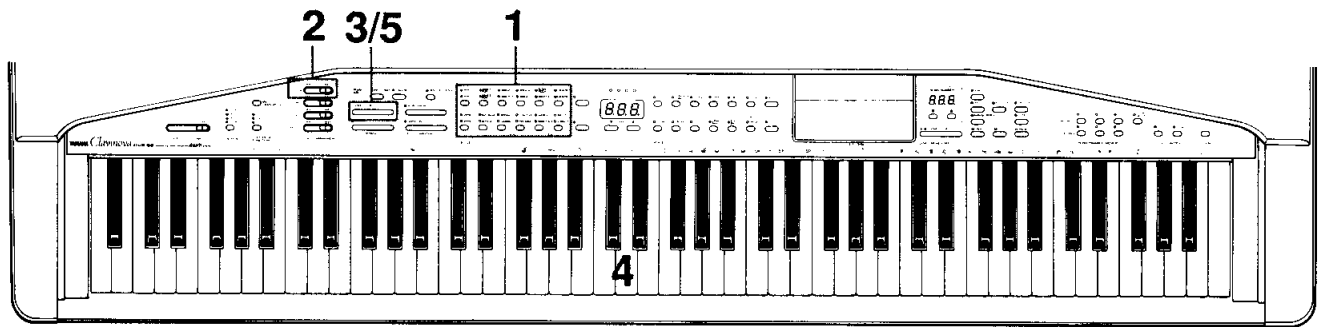

■ Play With Rhythm

1. Use the STYLE selectors to select a rhythm style [page 19].

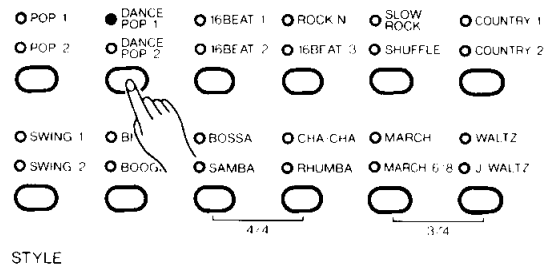

2. Set the [RHYTHM] volume control about three-quarters of the way to "MAX" [page 12].

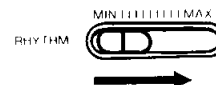

3. Press [START/STOP] [page 19].

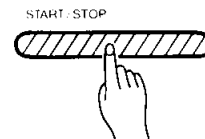

4. Play.

5. Press [START/STOP] to stop the rhythm [page 20].

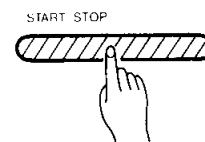

Quick Feature Guide

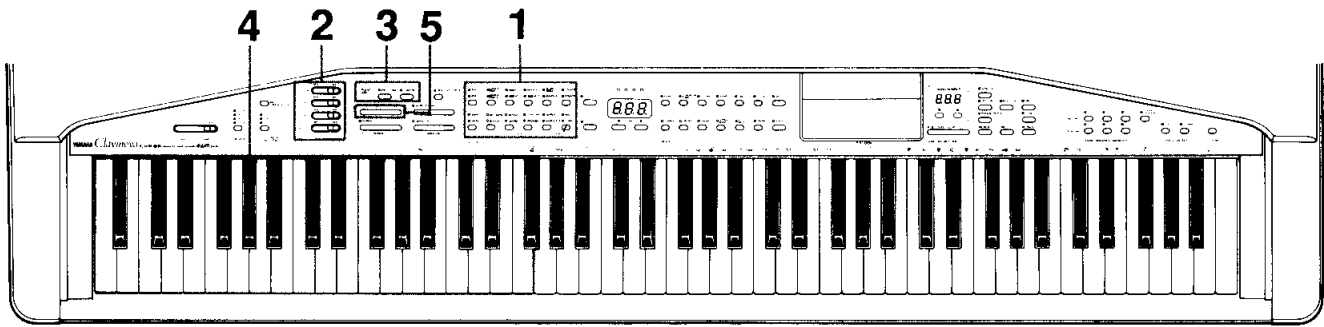

■ Play with Automatic Rhythm, Bass, & Chord Accompaniment (ABC)

1. Use the STYLE selectors to select a rhythm style [page 19].

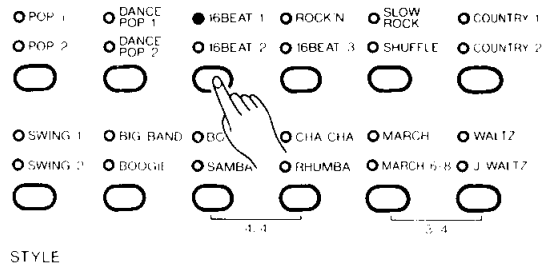

2. Set all ACCOMPANIMENT volume controls about three quarters of the way to "MAX" [page 12].

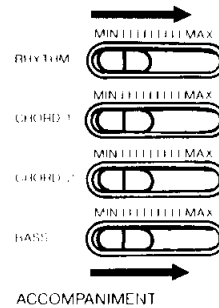

3. Press the [FINGERED] or [SINGLE FINGER] button.

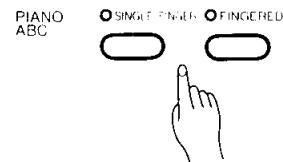

4. Play fingered [page 21] or single-finger [page 19] chords to the left of the F#2 key and melody to the right [page 21].

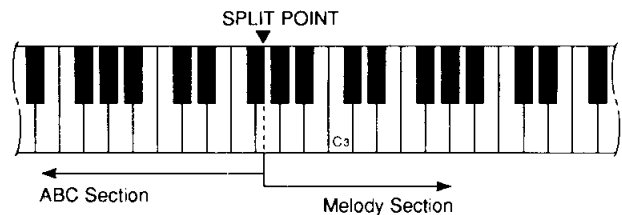

5. Press [START/STOP] to stop the accompaniment.

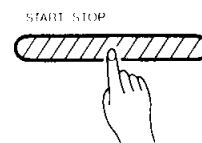

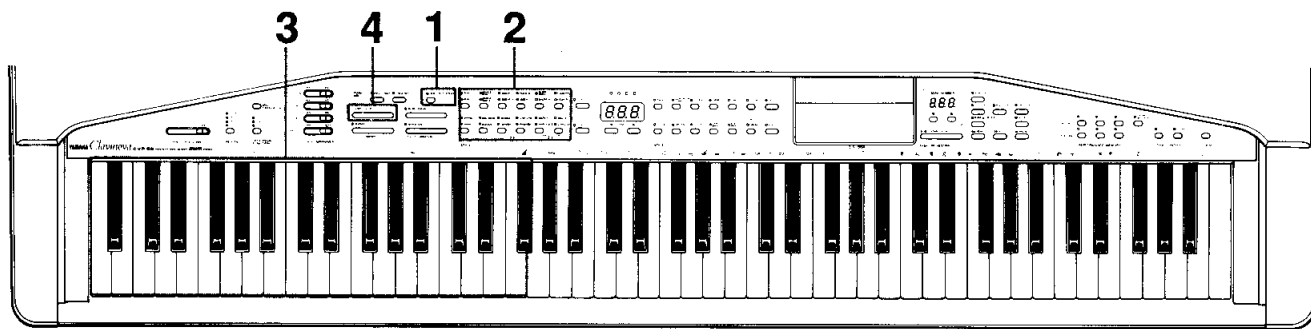

■ Play With ABC & Automatic Harmonization (SOLO STYLEPLAY)

1. Press the [SOLO STYLEPLAY] button [page 24].



2. Select an accompaniment style using the style selectors [page 19].

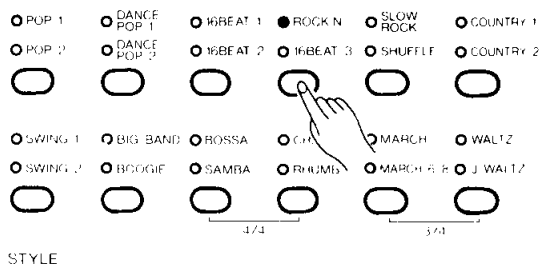

3. Play "single finger" or "fingered" chords [page 21] on the ABC section of the keyboard while playing a single-note melody line on the upper keyboard.

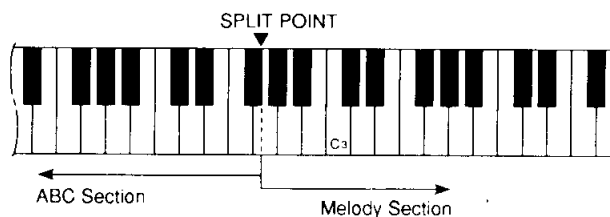

4. Press [START/STOP] to stop.

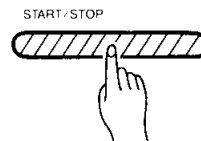

Quick Feature Guide

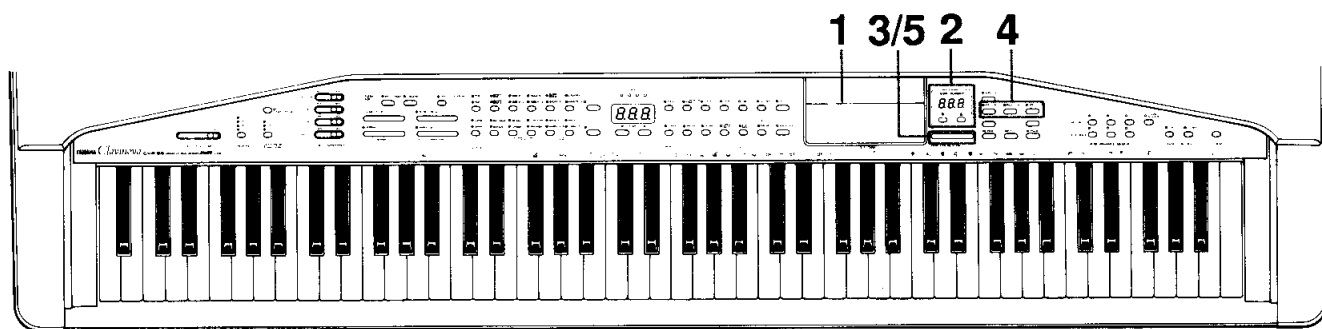

■ Play a “Disk Orchestra” Disk

1. Insert the DISK ORCHESTRA disk into the disk drive [page 25].

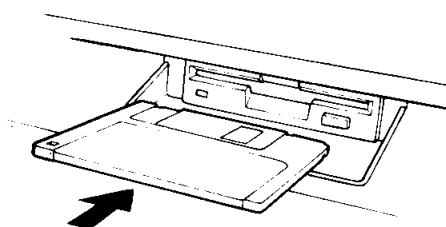

2. Use the SONG NUMBER [▲] and [▼] buttons below the display to select the desired song number or “ALL” [page 25].

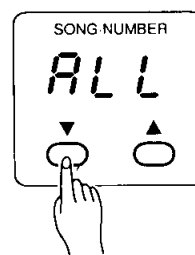

3. Press the DISK ORCHESTRA [START/STOP] button to start playback.

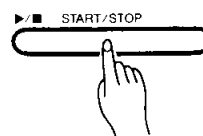

4. Use the [LEFT ON], [RIGHT ON], and [ORCHESTRA ON] buttons to turn the corresponding parts on or off as required [page 25].



5. Press [START/STOP] to stop playback. When you've finished with the currently loaded disk, simply press the disk drive EJECT button to remove it.

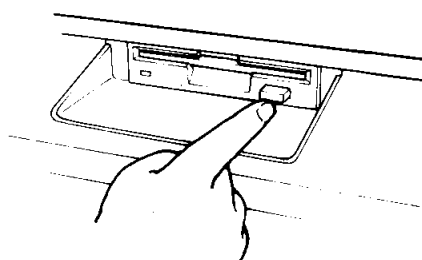
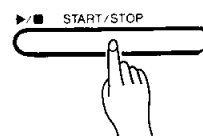

CAUTION:

NEVER eject a disk or turn the power off while:

- 1) the disk drive lamp is on.
- 2) the DISK ORCHESTRA function is playing.

Connections

OPTIONAL IN R and L Jacks

These jacks are intended primarily for use with Yamaha Expander Modules such as the EMT-1 FM Sound Box, EMT-10 AWM Sound Box, EMR-1 Drum Box, and DOM-30 Disk Orchestra Module.

In the case of the DOM-30 Disk Orchestra Module, for example, the LINE OUT jacks of the DOM-30 are connected to the Clavinova OPTIONAL IN jacks, allowing the sound of the DOM-30 to be reproduced via the Clavinova's internal amplifier and speaker system. Refer to the Expander Module device owner's manual for further details.



AUX. OUT R and L/L+R Jacks

The AUX. OUT R and L/L+R jacks deliver the output of the Clavinova for connection to an instrument amplifier, mixing console, PA system, or recording equipment. If you will be connecting the Clavinova to a monaural sound system, use only the L/L+R jack. When a plug is inserted into the L/L+R jack only, the left- and right-channel signals are combined and delivered via the L/L+R jack so you don't lose any of the Clavinova's sound.



Note: The AUX. OUT jack signal must never be returned to the OPTIONAL IN jacks, either directly or through external equipment.

MIDI IN, THRU and OUT Connectors

The MIDI IN connector receives MIDI data from an external MIDI device (such as the EMQ-1 Memory Box, DRC-20 Disk Recorder, or DOM-30 Disk Orchestra Module) which can be used to control the Clavinova. The MIDI THRU connector re-transmits any data received at the MIDI IN connector, allowing "chaining" of several MIDI instruments or other devices. The MIDI OUT connector transmits MIDI data generated by the Clavinova (e.g. note and velocity data produced by playing the Clavinova keyboard).

More details on MIDI are given in "MIDI FUNCTIONS" on page 32.



EXP. PEDAL Jack (CVP-65 only)

An optional Yamaha EP-1 Expression Pedal can be connected to this jack to allow foot expression (swell) control. Please note that the expression pedal does not apply to the rhythm/accompaniment sound.



HEADPHONES Jacks

One or two standard pairs of stereo headphones can be plugged in here for private practice or late-night playing. The internal speaker system is automatically shut off when a pair of headphones is plugged into either or both of the HEADPHONES jacks.



The Music Stand

If you will be using sheet music with your Clavinova, raise the music stand built into its top panel by lifting the rear edge of the music stand, flip the support brackets on the rear of the music stand down so that they fit into the corresponding recesses.

The music stand can be lowered after slightly lifting the stand and flipping the two brackets which support it upward.

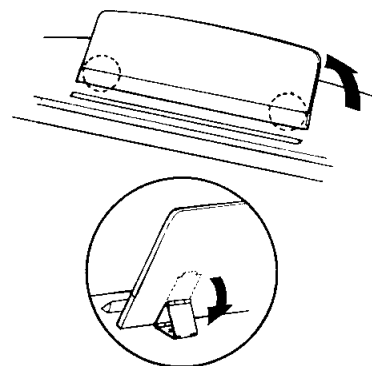

The Power Switch

After making sure that the Clavinova's AC plug is properly inserted into a convenient AC wall outlet, press the [POWER] switch located to the left of the keyboard once to turn the power on. Press the [POWER] switch again to turn the power off.

When the power is initially turned ON, the PIANO voice selector LED will light, the POP 1 style selector LED will light, and a "86" will appear on the TEMPO display.

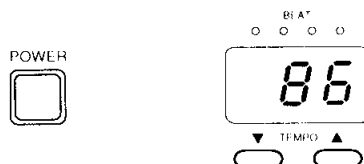

The Volume Controls

MASTER VOLUME

The MASTER VOLUME control adjusts the overall volume of sound produced by the Clavinova. It also adjusts headphone volume when one or two pairs of headphones are plugged into the HEADPHONES jacks.

Initially set the MASTER VOLUME control about half way between the "MIN" and "MAX" settings. Then, when you start playing, adjust the control for the most comfortable listening level.

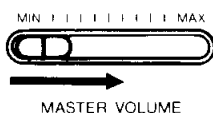

ACCOMPANIMENT

Separate volume controls are provided for the rhythm, chord 1, chord 2, and bass sound. These volume controls let you set up the best balance between the various accompaniment parts when the PIANO ABC feature is used, and the RHYTHM volume control can be used to balance the keyboard and rhythm sound when only rhythm is used.

The volume of the keyboard can be independently adjusted by using the [BASS] control while holding the [MIDI/TRANSCOPE] button — this is particularly handy for adjusting the balance when recording the Clavinova sound.

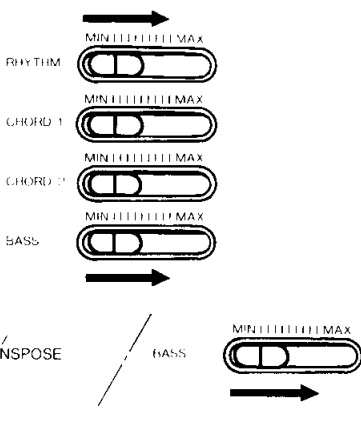

VIBRATO, PITCH BEND, & EXPRESSION CONTROL MODE

By pressing the [MARCH] style selector while holding the [MIDI/TRANSCOPE] button, the RHYTHM, CHORD 1, CHORD 2, and BASS volume controls are assigned to control vibrato, upward pitch bend, downward pitch bend, and expression, respectively. In this mode the RHYTHM control produces minimum vibrato when set to its minimum position, and maximum vibrato for the current voice (some voices do not have vibrato) when set to its maximum position. The CHORD 1 and CHORD 2 controls produce normal pitch when set to their minimum positions, and increase/decrease the pitch by a maximum of 300 cents (a cent is 1/100th of a semitone) at their maximum positions. The BASS control produces normal volume at its maximum position, and reduces volume to about 1/10 when moved to its minimum position.

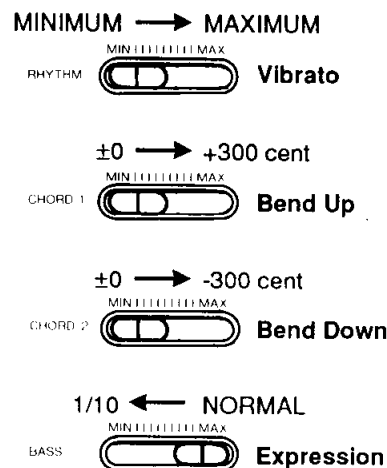

Press [MARCH] while holding [MIDI/TRANSCOPE] again to restore normal operation (the volume levels will not change regardless of the control settings).

The Internal Amplifier & Speaker System

The CVP-55/CVP-65 features a powerful stereo amplifier delivering 30 watts per channel, driving a unique Yamaha speaker system that puts out exceptionally rich sound with natural response from powerful lows to shimmering highs. The speaker system includes two 13-centimeter and two 5-centimeters speaker units.

Demonstration Playback

The CVP-55/CVP-65 features 24 demonstration tunes that effectively demonstrate its sound and accompaniment capabilities. Here's how you can select and play the demo tunes.

1. Press the [DEMO] button.



2. The 24 demo tunes are selected via the RHYTHM and VOICE selectors — the corresponding selector indicators light when the [DEMO] button is pressed. Press a selector to start playback of the corresponding tune. You can also select continuous repeat playback of all demo tunes by pressing the [START/STOP] button.

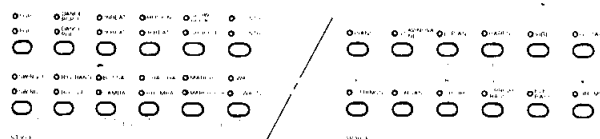

3. Use the MASTER VOLUME control to adjust the volume, and play along on the keyboard if you like.

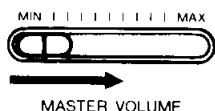

4. Demo playback can be stopped temporarily by pressing the [START/STOP] button. Press the [DEMO] button when you want to stop demo playback and return to the normal mode.



Demo Tunes

- [PIANO]
F. F. Chopin Fantaisie-impromptu Op. 66
- [CLAVINOVA TONE]
C. A. Debussy Réverie
- [HARPSICHORD]
J. S. Bach Italian Concert BWV971
- [STRINGS]
J. S. Bach Air on the G-string
- [ORGAN]
Saint-Saëns Symphony No. 3 Op. 78
- [CHOIR]
J. S. Bach Jesu, Joy Of Man's Desiring

• The demonstration pieces listed above are short excerpts from the original compositions. All other demo songs are original (© 1991 by YAMAHA CORPORATION).

Voice Selection

The CVP-55/CVP-65 has a total of 53 different voices, 12 of which can be directly accessed by pressing the corresponding VOICE selector.

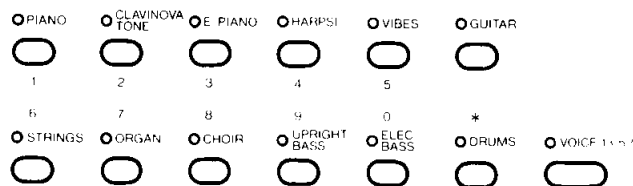

The remaining 41 voices can be selected in two different ways.

1. Using the [VOICE 13-53] button and the TEMPO [▲] and [▼] buttons.

Use the TEMPO [▲] and [▼] buttons to select a voice number between 13 and 53 while pressing the [VOICE 13-53] button (the voice number will appear on the TEMPO display).

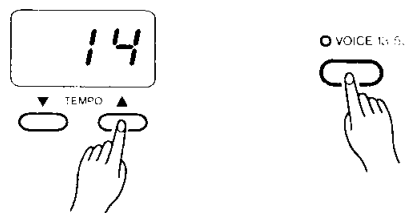

2. Using the VOICE selectors.

Enter the number of the desired voice via the voice selectors (note that each voice selector has a number between 1 and 0 associated with it) while pressing the [DRUMS] selector.

To select voice number 16, for example, press and hold [DRUMS], press [PIANO/1], then [STRINGS/6], then release the [DRUMS] button. The [VOICE 13-53] button LED will light whenever a voice number between 13 and 53 is selected.

If a voice between 1 and 12 is then selected, pressing the [VOICE 13-53] button will recall the previously selected voice in this range (the [VOICE 13-53] button will initially select voice number 13 BRASS after the power is turned on).

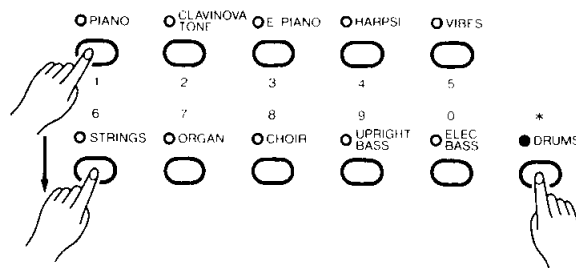

Voice Selection

Voices 13 — 53

No.	Voice	Usable Range
13	BRASS	F0 - C6
14	POP BRASS	F0 - C6
15	TRUMPET	F0 - C6
16	MUTE TRUMPET	F#2 - A5
17	HORN	A#0 - F4
18	SAXOPHONE	A#0 - F#5
19	SAXOPHONE SOFT	A#0 - F#5
20	CLARINET	E2 - A#5
21	OBOE	A#2 - G5
22	FLUTE	C2 - C7
23	ACCORDION	F2 - A5
24	HARMONICA	C3 - C6
25	STRINGS SOFT	C0 - C6
26	VIOLIN	C0 - C6
27	VIOLIN HARD	C0 - C6
28	FULL ORGAN	C0 - C6
29	JAZZ ORGAN	C1 - C6
30	SYNTH BRASS	C1 - C6
31	SYNTH WOOD	C2 - F#6
32	SYNTH STRINGS	C2 - E5
33	SYNTH CHOIR	C2 - E5
34	PIANO BRIGHT	—
35	PIANO SOFT	—
36	E. PIANO DX	—
37	SYNTH CRYSTAL	C2 - C6
38	CELESTA	—
39	MARIMBA	—
40	FOLK GUITAR	—
41	JAZZ GUITAR 1	—
42	JAZZ GUITAR 2	—
43	ROCK GUITAR 1	D2 - A5
44	ROCK GUITAR 2	D2 - A5
45	MUTE GUITAR	D2 - A5
46	BANJO	C3 - A5
47	PIZZICATO	C3 - C6
48	HARP	A0 - C7
49	UPRIGHT BASS SOFT	C0 - F#3
50	ELEC BASS SOFT	E0 - F#3
51	ELEC BASS HEAVY	E0 - F#3
52	SYNTH BASS	E0 - F#3
53	TIMPANI	C0 - F#2

• When the DRUMS voice is selected only the keys with drum or percussion symbols printed above them will sound.

• The PIANO voice is automatically selected when the power is initially turned ON.

Keyboard Percussion

When the DRUMS voice selector is pressed (its indicator will light), you can play 41 different drum and percussion instruments on the keyboard. The percussion instruments played by the various keys are marked by symbols above the keys (keys with no symbols produce no sound).



• The PITCH and TRANSPOSE functions described on page 18 do not affect the DRUMS sound.

DRUM & PERCUSSION INSTRUMENT KEY ASSIGNMENTS

Key	Instrument	Key	Instrument
F#2	BRUSH ROLL	G#4	CRASH CYMBAL
G#2	HI-HAT CLOSED HEAVY	C5	CONGA LOW
A#2	CRASH CYMBAL LIGHT	C#5	CABASA
B2	BASS DRUM LIGHT	D5	CONGA HIGH
C3	SNARE DRUM + RIM HEAVY	D#5	METRONOME
C#3	RIDE CYMBAL CUP	E5	BONGO
D3	SNARE DRUM + RIM LIGHT	F5	TIMBALE LOW
F3	BASS DRUM	F#5	CLAVES
F#3	RIM SHOT	G5	TIMBALE HIGH
G3	SNARE DRUM HEAVY	G#5	CASTANETS
G#3	BRUSH SHOT	A5	CUICA LOW
A3	SNARE DRUM LIGHT	A#5	COWBELL
A#3	HI-HAT PEDAL	B5	CUICA HIGH
B3	SNARE DRUM ECHO	C6	HAND CLAPS
C4	TOM 4	C#6	AGOGO LOW
C#4	HI-HAT CLOSED	D#6	AGOGO HIGH
D4	TOM 3	E6	BONGO LOW
D#4	HI-HAT OPEN	F#6	TAMBOURINE
E4	TOM 2	G#6	TRIANGLE CLOSED
F4	TOM 1	A#6	TRIANGLE OPEN
F#4	RIDE CYMBAL	—	—

• Cymbals can be muted by pressing the A1 key.

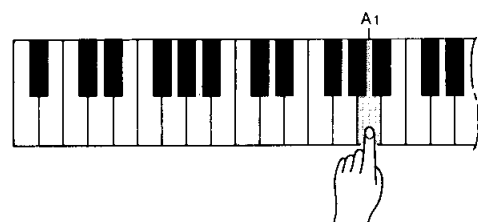

Dual Mode

The DUAL mode makes it possible to play two voices simultaneously across the entire range of the keyboard. To activate the DUAL mode simply press two voice selectors at the same time — or press one voice selector while holding another. The currently selected voice (13-53) can be “dual” with one of the panel voices by pressing the [VOICE 13-53] button and a voice selector at the same time (two voices in the 13-53 range cannot be combined).

The voice indicators of both selected voices will light when the DUAL mode is active. To return to the normal single-voice play mode, press any single voice selector.

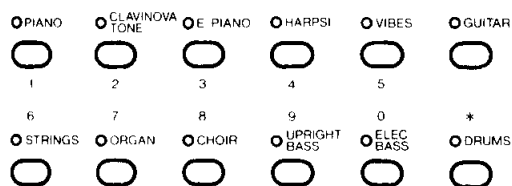

Dual-mode Voice Balance

The volume balance between the two voices combined in the DUAL mode can be adjusted by using the TEMPO [▲] and [▼] buttons while holding the [SPLIT] button. The selected balance value (1 ... 15) will be shown on the TEMPO display while the TEMPO [▲] and [▼] buttons are held.



- A setting of “1” sets the volume of the lowest-numbered voice to maximum and the highest-numbered voice to minimum.
- A setting of “8” sets both voices to the same volume (this is the default balance setting, and can be recalled at any time by pressing the TEMPO [▲] and [▼] buttons simultaneously).
- A setting of “15” sets the volume of the highest-numbered voice to maximum and the lowest-numbered voice to minimum.

NOTE: The dual mode cannot be used when the DRUMS voice is selected. Also, the dual and split modes cannot be used at the same time.

Split Mode

When the [SPLIT] button is pressed and its indicator lights, the keyboard is split into left- and right-hand sections and different voices can be assigned to each (any of the CVP-55/65 voices can be used). The split point is initially set at the F#2 key when the power is turned on, and the UPRIGHT BASS voice is initially assigned to the left-hand section of the keyboard (all keys up to and including F#2). The voice that was selected when the SPLIT mode was engaged is assigned to the right-hand section of the keyboard. The current settings are retained if the SPLIT mode is turned off and on while the power remains on.

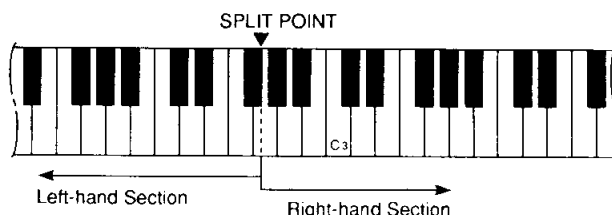

Changing Voices

The right-hand voice can be changed simply by pressing the appropriate voice selector.

The left-hand voice can be changed by pressing a voice selector while holding the [SPLIT] button.

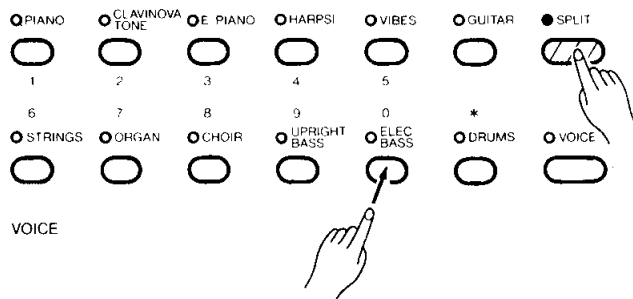

- The all voices except BASS and DRUMS are shifted up one octave when assigned to the lower section of the keyboard.

Changing the Split Point

The split point can be set at any key by pressing the desired key while holding the [SPLIT] button. In the CVP-65 a guide lamp will indicate the selected split point.

The default split point — F#2 — will always be set automatically whenever the power is initially turned ON.

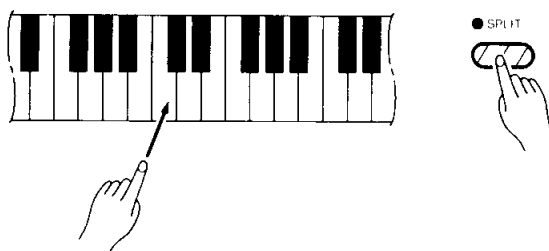

Split Mode

Split Balance

The volume balance between the left-hand and right-hand voices can be adjusted by using the TEMPO [▲] and [▼] buttons while holding the [SPLIT] button. The selected balance value (1 ... 15) will be shown on the TEMPO display while the TEMPO [▲] and [▼] buttons are held.

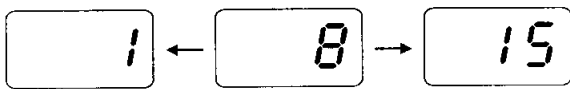

- A setting of "1" sets the volume of the left voice to maximum and the right voice to minimum.
- A setting of "8" sets both voices to the same volume (this is the default balance setting, and can be recalled at any time by pressing the TEMPO [▲] and [▼] buttons simultaneously).
- A setting of "15" sets the volume of the right voice to maximum and the left voice to minimum.

Damper Pedal Operation in the Split Mode

The CVP-55/CVP-65 damper pedal (the right pedal — see "The Pedals" below) can be assigned to the left voice only, the right voice only, or to both voices in the split mode.

- Right Voice Only (default): Press the damper pedal while holding the [SPLIT] button.
- Left Voice Only: Press the left (soft) pedal while holding the [SPLIT] button.
- Both Voices: Press both the damper and left pedals while holding the [SPLIT] button.

NOTE: The dual and split modes cannot be used at the same time.

NOTE: In the split the soft and sostenuto pedal functions apply to both the left- and right-hand voices.

NOTE: When the Piano ABC Single Finger mode (page 21) and the split mode are used simultaneously, the left-hand voice will be accompanied by the appropriate ABC chord voices.

Digital Reverb Effects

The [REVERB] button provides a number of digital effects that you can use for extra depth and expressive power. Each time the [REVERB] button is pressed the next effect on the reverb "list" is selected and the corresponding indicator will light. No effect is selected when no indicator is lit.

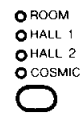

OFF (No indicator lit)
No effect is produced.

ROOM

This setting adds a reverb effect to the sound that is similar to the type of acoustic reverberation you would hear in a medium-size room.

HALL 1

For a more spacious reverb sound, use the HALL 1 setting. This effect simulates the natural reverberation of a medium-size concert hall.

HALL 2

HALL 2 simulates the reverb of a very large concert hall.

COSMIC

"COSMIC" is an echo effect in which the sound seems to "bounce" around in the stereo sound field.

- The ROOM effect is automatically selected when the POWER switch is turned on.

Reverb Depth Control

The depth of the selected reverb effect can be increased or decreased by pressing the TEMPO [▲] or [▼] button while holding the [REVERB] button. The reverb depth is shown on the TEMPO display while the [REVERB] and [▲] or [▼] buttons are held. The reverb depth range is from "0" (no effect) to "15" (maximum depth).

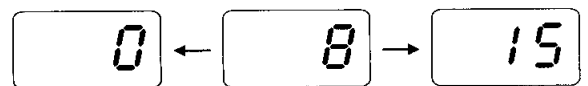

- Reverb depth is initially set to "8" when the power is turned on (this setting can be recalled at any time by pressing the TEMPO [▲] and [▼] buttons simultaneously).

- To preserve overall balance and sound quality, relatively shallow reverb is applied to the bass and rhythm sound.

The Keyboard & Polyphony

The Clavinova has "32-note polyphony" which means you can normally play up to 32 notes at once. This number varies, however, according to the functions being used, as shown in the chart below:

Keyboard only	32 notes.
Keyboard only (dual)	16 notes.
Keyboard + rhythm	24 notes (rhythm uses 8).
Keyboard + ABC	16 notes (rhythm 8; ABC 8).

• Some voices have half the number of notes listed above in order to produce the best possible sound quality.

The Clavinova also offers keyboard touch response, so the volume and timbre of notes played can be controlled according to how "hard" you play the keys. The amount of variation available depends on the selected voice.

The Pedals

Right Pedal (Damper Pedal)

The damper pedal functions in the same way as a damper pedal on an acoustic piano. When the damper pedal is pressed notes played have a long sustain. Releasing the pedal immediately stops (damps) any sustained notes.

Center Pedal (Sostenuto Pedal, CVP-65 only)

If you play a note or chord on the keyboard and press the sostenuto pedal while the note(s) are held, those notes will be sustained as long as the pedal is held (as if the damper pedal had been pressed) but all subsequently played notes will not be sustained. This makes it possible to sustain a chord, for example, while other notes are played "staccato."

The sostenuto pedal cannot be used while the SOLO STYLEPLAY feature is operating.

Left Pedal (Multi-function)

The left pedal has a number of functions which can be selected using the [LEFT PEDAL FUNCTION] button and indicators. Each time the [LEFT PEDAL FUNCTION] button is pressed the next function on the LEFT PEDAL function "list" is selected and the corresponding indicator will light.

○ SOFT
○ SOSTENUTO
○ START/STOP
○ SOLO STYLEPLAY



CVP-55

○ SOFT
○ START/STOP
○ SOLO STYLEPLAY



CVP-65

SOFT

Pressing the soft pedal reduces the volume and slightly changes the timbre of notes played. The SOFT function is automatically selected whenever the POWER switch is turned on.

SOSTENUTO (CVP-55 only)

If you play a note or chord on the keyboard and press the sostenuto pedal while the note(s) are held, those notes will be sustained as long as the pedal is held (as if the damper pedal had been pressed) but all subsequently played notes will not be sustained. This makes it possible to sustain a chord, for example, while other notes are played "staccato."

The CVP-55 left-pedal SOSTENUTO function cannot be used while the SOLO STYLEPLAY feature is operating.

START/STOP

For details on the START/STOP function, refer to the "RHYTHM" section on page 19.

SOLO STYLEPLAY

For details on the SOLO STYLEPLAY function see "SOLO STYLEPLAY" on page 24 (the SOLO STYLEPLAY pedal function can only be selected when the SOLO STYLEPLAY feature is in use).

Touch Sensitivity

The CVP-55/CVP-65 can be set to one of three different types of keyboard touch sensitivity — HARD, MEDIUM or SOFT — to match different playing styles and preferences.

- The HARD setting requires the keys to be played quite hard to produce maximum loudness.
- The MEDIUM setting produces a fairly "standard" keyboard response.
- The SOFT setting allows maximum loudness to be produced with relatively light key pressure.

To select a touch sensitivity setting hold the [MIDI/TRANSCOPE] button and press the corresponding STYLE button:

- POP 1 = HARD
- DANCE POP 1 = MEDIUM
- 16 BEAT 1 = SOFT

The MEDIUM setting is automatically selected whenever the POWER switch is turned on.

Transposition

The Clavinova's TRANSCOPE function makes it possible to shift the pitch of the entire keyboard up or down in semitone intervals up to a maximum of six semitones. "Transposing" the pitch of the Clavinova keyboard makes it easier to play in difficult key signatures, and you can simply match the pitch of the keyboard to the range of a singer or other instrumentalist.

Use the TEMPO [▲] and [▼] buttons to select the desired degree of transposition while holding the [MIDI/TRANSCOPE] button.

The amount of transposition selected is shown on the TEMPO indicator as follows:

Display	Transposition	Display	Transposition
-6	-6 semitone	0	Normal
-5	-5 semitones	1	+1 semitone
-4	-4 semitones	2	+2 semitones
-3	-3 semitones	3	+3 semitones
-2	-2 semitones	4	+4 semitones
-1	-1 semitone	5	+5 semitones
0	Normal	6	+6 semitones

- Press the [▲] and [▼] buttons simultaneously while holding the MIDI/TRANSCOPE button to restore normal keyboard pitch.
- Transpose is always set to Normal when the power is turned on.
- The TRANSCOPE function does not affect the DRUMS sound.

Pitch Control

Pitch control makes it possible to tune the Clavinova over a ± 50 -cent range in approximately 1.2-cent intervals. A hundred "cents" equals one semitone, so the tuning range provided allows fine tuning of overall pitch over a range of approximately a semitone. Pitch control is useful for tuning the Clavinova to match other instruments or recorded music.

Tuning Up

1. To tune up (raise pitch), hold the A-1 and B-1 keys simultaneously (A-1 and B-1 are the two lowest white keys on the keyboard) and press any key between C3 and B3. Each time a key in this range is pressed the pitch is increased by approximately 1.2 cents, up to a maximum of 50 cents above standard pitch.
2. Release the A-1 and B-1 keys.

Tuning Down

1. To tune down (lower pitch), hold the A-1 and A#-1 keys simultaneously and press any key between C3 and B3. Each time a key in this range is pressed the pitch is decreased by approximately 1.2 cents, up to a maximum of 50 cents below standard pitch.
2. Release the A-1 and A#-1 keys.

To Restore Standard Pitch*

1. To restore standard pitch (A3 = 440 Hz), hold the A-1, A#-1, and B-1 keys simultaneously and press any key between C3 and B3.
2. Release the A-1, A#-1, and B-1 keys.

* Standard pitch (A3 = 440 Hz) is automatically set whenever the POWER switch is initially turned ON.

• The PITCH function does not affect the DRUMS sound.



The Pitch Display

The approximate pitch of A3 is shown on the TEMPO display in Hertz while the pitch control function is in operation. The total display range is from 427 to 453 hertz.

The dots to the right of each figure in the display are used to provide a general idea of fractional pitches. For example:

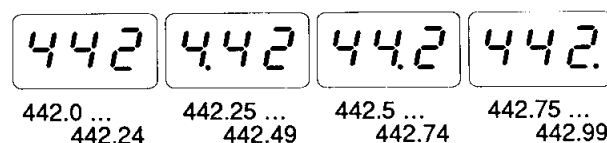

Rhythm

The CVP-55/CVP-65 has 24 "styles" that can be used as a basis for rhythm, or fully orchestrated rhythm, bass, and chord accompaniment (see "Piano ABC" on page 21).

Style Selection

The 24 patterns are selected using 12 STYLE selectors. Note that each style selector has two indicators and style names above it. These two styles are selected alternately each time the selector is pressed.

The POP 1 rhythm is automatically selected when the power is initially turned on.

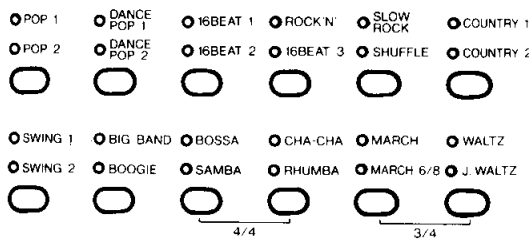

Tempo Control

Whenever you select a different style, the "suggested" tempo for that style is also selected, and the tempo is displayed on the TEMPO display in quarter-note beats per minute (unless the accompaniment is playing, in which case the same tempo is maintained).

You can change the tempo to any value between 32 and 280 beats per minute, however, by using the TEMPO [▲] and [▼] buttons. This can be done either before the accompaniment is started or while it is playing. Press either button briefly to decrement or increment the tempo value by one, or hold the button for continuous decrementing or incrementing. Press lightly for slow, or harder for fast decrementing or incrementing.



NOTE: The suggested tempo for the selected style can be recalled at any time by pressing both the [▲] and [▼] buttons simultaneously.

Suggested Tempos

Style	Suggested tempo	Style	Suggested tempo
POP 1	86	SWING 1	176
POP 2	80	SWING 2	160
DANCE POP 1	120	BIG BAND	152
DANCE POP 2	120	BOOGIE	160
16 BEAT 1	72	BOSSA	144
16 BEAT 2	100	SAMBA	120
ROCK'N'	152	CHA-CHA	126
16 BEAT 3	72	RHUMBA	120
SLOW ROCK	72	MARCH	120
SHUFFLE	104	MARCH 6/8	116
COUNTRY 1	112	WALTZ	192
COUNTRY 2	120	J. WALTZ	160

Starting the Rhythm

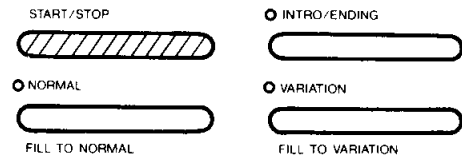

There are several ways to start the rhythm:

- **Straight start:** Press the [START/STOP] button. Each of the rhythm styles also has a variation that can be selected by pressing the [VARIATION/FILL TO VARIATION] button (its LED will light) before pressing the [START/STOP] button. Normally the [NORMAL/FILL TO NORMAL] button LED will be lit (or you can select it if the variation is selected), indicating that the normal pattern is selected.

[NORMAL/FILL TO NORMAL]

↓
[START/STOP]

||
Normal straight start.

[VARIATION/FILL TO VARIATION]

↓
[START/STOP]

||
Variation straight start.

- **Start with an introduction:** Press the [INTRO/ENDING] button.

If you press the [NORMAL/FILL TO NORMAL] or [VARIATION/FILL TO VARIATION] button while holding the [INTRO/ENDING] button, the rhythm will start with an appropriate fill and then go to the normal rhythm or variation rhythm, respectively.

[INTRO/ENDING]

↓
[START/STOP]

||
Intro start.

[INTRO/ENDING] + [NORMAL/FILL TO NORMAL]

↓
[START/STOP]

||
Fill start to normal.

[INTRO/ENDING] + [VARIATION/FILL TO VARIATION]

↓
[START/STOP]

||
Fill start to variation.

- **Synchronized start:** Any of the start types described above can be synchronized to the first note or chord played by first pressing the [MIDI/TRANSCOPE] and [NORMAL/FILL TO NORMAL] buttons simultaneously. When the SPLIT mode is engaged, this function causes rhythm start to be synchronized to the first note or chord played on the left-hand section of the keyboard (i.e. keys to the left of and including the split-point key — normally F#2). Once the synchronized start mode has been selected, use the [NORMAL/FILL TO NORMAL], [VARIATION/FILL TO VARIATION] and/or [INTRO/ENDING] buttons to select the type of start you want.

The first dot of the BEAT display will flash at the current tempo when a synchronized start mode has been selected.

After pressing
[MIDI/TRANSCOPE] + [NORMAL/FILL TO NORMAL] ...

[NORMAL/FILL TO NORMAL]

↓
Lower key

||
Normal straight start.

[VARIATION/FILL TO VARIATION]

↓
Lower key

||
Variation straight start.

[INTRO/ENDING]

↓
Lower key

||
Intro start.

[INTRO/ENDING] + [NORMAL/FILL TO NORMAL]

↓
Lower key

||
Fill start to normal.

[INTRO/ENDING] + [VARIATION/FILL TO VARIATION]

↓
Lower key

||
Fill start to variation.

The synchronized start mode will be cancelled if the rhythm is stopped by pressing the [START/STOP] button. It can also be cancelled by pressing the [MIDI/TRANSCOPE] + [NORMAL/FILL TO NORMAL] buttons a second time.

NOTE: The current measure number is shown on the TEMPO display once the rhythm has been started.

Beat Display

The four LED dots of the BEAT display provide a visual indication of the selected tempo. The leftmost (red) dot flashes on the first beat of each measure, the second dot flashes on the second beat, and so on (all dots except the leftmost dot are green).

When a 3/4-time rhythm is selected, only the first three dots will flash.

		BEAT			
1st. Beat	●	○	○	○	○
2nd. Beat	○	●	○	○	○
3rd. Beat	○	○	●	○	○
4th. Beat	○	○	○	○	●

Fill-ins

The CVP-55/CVP-65 provides two types of automatic breaks or "fill-ins."

- **Fill To Normal:** Press the [NORMAL/FILL TO NORMAL] button to produce a fill and go to the normal rhythm.

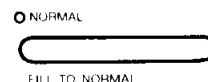

- **Fill To Variation:** Press the [VARIATION/FILL TO VARIATION] button to produce a fill and go to the variation pattern.

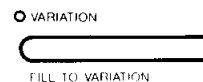

If you hold one of the FILL buttons, the fill-in will repeat until the end of the measure in which button is released.

Stopping the Rhythm

The rhythm can be stopped at any time by pressing the [START/STOP] button. Press the [INTRO/ENDING] button if you want to go to the ending pattern and then stop.



NOTE: If the left pedal is switched to START/STOP operation, it performs the same function as the panel [START/STOP] buttons (press to START, press again to STOP).

Metronome

The CVP-55/CVP-65 also offers straightforward 4/4 and 3/4 metronome patterns that are ideal for practice.

- To select and start the 4/4 metronome, press the [BOSSA] and [CHA-CHA] style selectors simultaneously.

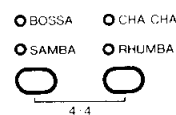

- To select and start the 3/4 metronome, press the [MARCH] and [WALTZ] style selectors simultaneously.

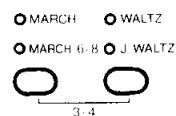

Press [STOP/START] to stop the metronome sound.

You can also press the [VARIATION/FILL TO VARIATION] button to select a metronome pattern without the accented first beat.

Piano ABC

The CVP-55/CVP-65 includes a sophisticated auto-accompaniment system that can provide automated rhythm, bass and chord backing in a number of ways.

Single-finger Accompaniment

SINGLE FINGER accompaniment makes it simple to produce accompaniment using major, seventh, minor and minor-seventh chords by pressing a minimum number of keys in the ABC section of the keyboard. The automatic accompaniment consists of rhythm, bass and chords.

1. Press the [SINGLE FINGER] button to select the SINGLE FINGER mode (the SINGLE FINGER indicator will light).

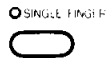

2. Select the desired accompaniment using the style selectors (see "Style Selection" on page 19).
3. Use the TEMPO [▲] and [▼] buttons to set the desired accompaniment tempo if necessary (see "Tempo Control" on page 19).
4. Pressing any key on the ABC section of the keyboard (up to the split point — normally the F#2 key) will cause the automatic chord and bass accompaniment to begin (synchro start is automatically selected in the ABC mode*). If you press a "C" key, for example, a C-major accompaniment will be played. Press another key in the Auto Accompaniment Keys section to select a new chord. The key you press will always determine the "root" of the chord played (i.e. "C" for a C chord).

* The synchronized start mode can be off or on by pressing the [NORMAL/FILL TO NORMAL] button while holding the [MIDI/TRANSCOPE] button.

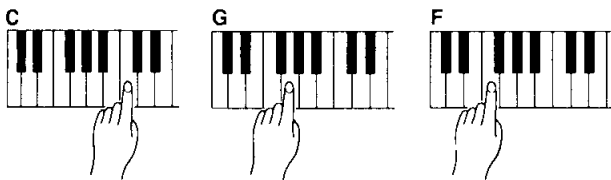

Playing Minor, Seventh, and Minor-seventh Chords in the Single-finger Mode



- For a minor chord, press the root key and the first black key to its left.
- For a seventh chord, press the root key and the next white key to its left.
- For a minor-seventh chord, press the root key and both the next white and black keys to its left.

5. Press the [START/STOP] or [INTRO/ENDING] button to stop the accompaniment.

Fingered Accompaniment

The FINGERED mode is ideal if you already know how to play chords on a keyboard, since it allows you to supply your own chords for the Auto Accompaniment feature.

1. Press the [FINGERED] button to select the FINGERED mode (the FINGERED indicator will light).



2. Select an accompaniment style using the style selectors (see "Style Selection" on page 19).
3. Use the TEMPO [▲] and [▼] buttons to set the desired accompaniment tempo if necessary (see "Tempo Control" on page 19 for more details).
4. As soon as you play any chord (up to 4 notes) on the lower keyboard (up to the split point — normally the F#2 key), the CVP-55/CVP-65 will automatically begin to play the chord along with the selected rhythm and an appropriate bass line (synchro start is automatically selected in the ABC mode*).

* The synchronized start mode can be off or on by pressing the [NORMAL/FILL TO NORMAL] button while holding the [MIDI/TRANSCOPE] button.

The CVP-55/CVP-65 will accept the following 20 chord types:

- Major [Maj]
- Minor [m]
- Major seventh [M7]
- Sixth [6th]
- Seventh [7th]
- Minor sixth [m6]
- Minor seventh [m7]
- Minor major seventh [mM7]
- Minor seventh flat five [m7-5]
- Minor flat five [m-5]
- Major flat five [M-5]
- Seventh flat five [7-5]
- Major seventh flat five [M7-5]
- Seventh suspended fourth [7sus4]
- Suspended fourth [sus4]
- Augmented [aug]
- Seventh sharp five [7+5]
- Major seventh sharp five [M7+5]
- Diminished [dim]
- Half diminished (minor major seventh flat five) [mM7-5]

NOTE: The automatic accompaniment will sometimes not change when related chords are played in sequence (e.g. a minor chord followed by the minor seventh).

NOTE: The [INTRO/ENDING], [NORMAL/FILL TO NORMAL], and [VARIATION/FILL TO VARIATION] buttons can be used in the PIANO ABC mode to create pattern variations in the same way that they are used with rhythm patterns (refer to the "Rhythm" section on page 19 for details).

[NORMAL/FILL TO NORMAL]

↓
Lower key
||

Normal straight start.

[VARIATION/FILL TO VARIATION]

↓
Lower key
||

Variation straight start.

[INTRO/ENDING]

↓
Lower key
||

Intro start.

[INTRO/ENDING] + [NORMAL/FILL TO NORMAL]

↓
Lower key
||

Fill start to normal.

[INTRO/ENDING] + [VARIATION/FILL TO VARIATION]

↓
Lower key
||

Fill start to variation.

5. Press the [START/STOP] or [INTRO/ENDING] button to stop the accompaniment.

Full-keyboard ABC

The Full-keyboard ABC mode can be engaged by pressing the [SINGLE FINGER] and [FINGERED] buttons simultaneously (both indicators will light). In this mode the split point is de-activated and notes played anywhere on the keyboard are detected and used to determine the harmonization of the accompaniment. Chord detection is possible when at least three notes are played simultaneously over the entire range of the keyboard. Press either the [SINGLE FINGER] or [FINGERED] button twice to exit from the Full-keyboard ABC mode.

- Some of the chord types listed on page 21 cannot be detected in this mode.

Volume Control

The RHYTHM, CHORD 1, CHORD 2, and BASS volume controls can be used to adjust the volume of the corresponding accompaniment parts when using the ABC mode. The CVP-55/65 accompaniments are balanced to produce the best possible sound with the RHYTHM, CHORD 1, CHORD 2, and BASS volume controls set about 3/4 of the way toward MAX. If the chord patterns interfere with the melody or other right-hand chords you are playing, however, try turning the CHORD 2 volume control down. You can also turn both the CHORD 1 and CHORD 2 volume controls all the way down, and play with just the bass and rhythm parts.

The volume of the keyboard can be independently adjusted by using the BASS volume control while holding the [MIDI/TRANPOSE] button.

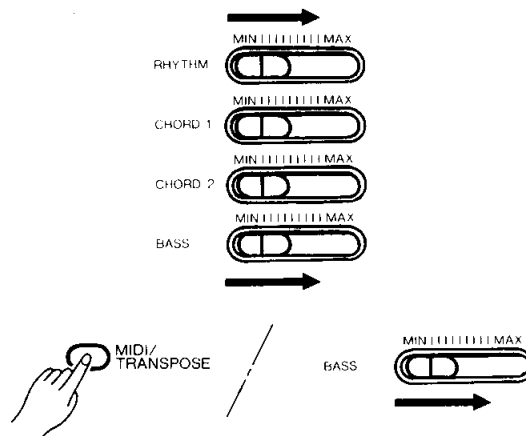

Changing the Split Point

The ABC split point can be set at any key by pressing the desired key while holding the [SINGLE FINGER] or [FINGERED] button.

The default split point — F#2 — will always be set automatically whenever the power is initially turned ON.

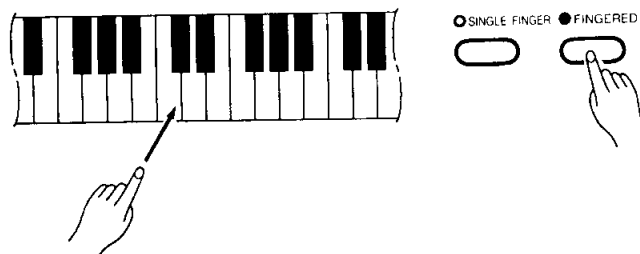

Style Disk (CVP-65 only)

A Style Disk is supplied with the CVP-65, providing an extra 40 accompaniment styles. Any two of these styles can be loaded into the CVP-65 memory at a time. The [DISK STYLE 1] and [DISK STYLE 2] buttons select the loaded disk styles in the same way as the STYLE selectors select the internal styles.

Selecting & Loading Style Disk Patterns

1. Insert the style disk into the CVP-65 disk drive with the metallic door facing the drive slot and the label side facing upward. The disk should click into place and the disk lamp will light briefly while the CVP-65 reads and identifies the disk.

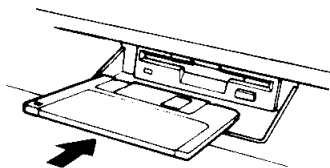

2. Press the [SONG SELECT] button. When this is done the [DISK STYLE 1] and [DISK STYLE 2] button indicators will flash, and the single-finger ABC mode and synchronized start mode will be engaged (the fingered ABC mode will remain active if it was selected when the disk was loaded).

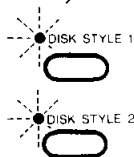

3. Use the [▲] and [▼] buttons below the SONG NUMBER display to select the desired accompaniment style number.* You can "preview" the selected accompaniment style by playing on the left-hand section of the keyboard (single-finger or fingered). Accompaniment playback will stop if a different style number is selected.

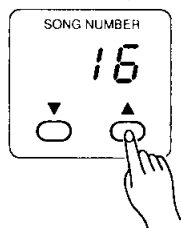

* Style numbers can also be selected by using the voice selectors (note that each voice selector has a number between 1 and 0 associated with it) while pressing the [DRUMS] selector. To select style number 16, for example, press and hold [DRUMS], press [PIANO/1], then [STRINGS/6], then release the [DRUMS] button.

4. Press the [DISK STYLE 1] or [DISK STYLE 2] button to load the selected style into that button. The [DISK STYLE 1] or [DISK STYLE 2] indicator will light, and the [SONG SELECT] indicator will go out.
5. Repeat steps 2 through 4 to select and load a second style into the other [DISK STYLE] button if you like.

Style Disk Pattern List

Group	No.	Name	Song Examples
ROCK	1	AMERICAN POP	Material Girl
	2	60'S	A Hard Day's Night
	3	SOUL ROCK	Rio Funk
	4	16 BEAT	Copacabana
	5	ROCK BALLAD	Bridge Over Troubled Water
	6	COUNTRY ROCK	Green, Green Grass Of Home
	7	PIANO BALLAD	My Way
	8	SOLO PIANO	Sunflower
SOUL	9	RHYTHM & BLUES	In The Midnight Hour
	10	GOSPEL	Amazing Grace
	11	BLUES SHUFFLE	Buttons And Bows
JAZZ	12	CONTEMPORARY	Sweet Georgia Brown
	13	DIXIE	When The Saints Go Marching In
	14	RAGTIME	The Entertainer
LATIN	15	TANGO 1	El Choclo
	16	TANGO 2	La Cumparsita
	17	LAMBADA	Lambada
	18	SAMBA	Tico-tico
	19	BOSSA 1	Wave
	20	BOSSA 2	You Are The Sunshine Of My Life
	21	REGGAE	I Shot The Sheriff
	22	LATIN POP	El Bimbo
	23	LATIN ROCK	Cachito
	24	CHA-CHA	Oye Como Va
WALTZ	25	WALTZ	Chim Chim Cher-ee
	26	VIENNESE WALTZ	Tales From Vienna Woods
	27	CHANSON	Domino
WORLD	28	POLKA	Beer Barrel Polka
	29	HAWAIIAN	Aloha Oe
	30	CALYPSO	St. Thomas
	31	NEW AGE	Silk Road
	32	COUNTRY SHUFFLE	Stagecoach
	33	FOLKLORE	El Humahuagueño
	34	JAPANESE POP 1	—
	35	JAPANESE POP 2	—
	36	JAPANESE POP 3	—
	37	JAPANESE POP 4	—
	38	ENKA 1	—
	39	ENKA 2	—
	40	ONDO	—

Style Disk (CVP-65 only)

Using a Loaded Style Disk Pattern

After you've loaded the desired Style Disk patterns, the [DISK STYLE 1] and [DISK STYLE 2] buttons can be used in exactly the same way as the other STYLE buttons to select the loaded patterns for ABC accompaniment (see "Piano ABC" beginning on page 21).

The number of the Style Disk pattern selected by the [DISK STYLE 1] or [DISK STYLE 2] button will be shown on the SONG NUMBER display.

Style Disk Auto Load

Loaded Style Disk patterns are not backed up and will be lost when the CVP-65 power is turned off. The selected pattern(s) can be automatically loaded from the disk when the power is turned on, however, if:

1. The write-protect tab of the style disk is set to the "write" position (tab closed) when the patterns are selected and loaded (preferably, disk containing copies of the required patterns should be used — see the "Disk Control" section beginning on page 30).

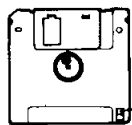

Write Protect tab

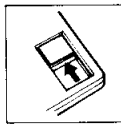

Write Protect OFF

2. The style disk is in the floppy disk drive when the power is turned on.

Solo Styleplay

This sophisticated feature not only provides automatic rhythm, bass and chord accompaniment, but it also adds appropriate harmony notes (two or three harmonized notes) to a melody you play on the upper keyboard.

- Solo Styleplay patterns are programmed for each of the 24 styles accessible via the CVP-55/65 STYLE selectors. When using any of the 40 disk styles, an appropriate Solo Styleplay pattern will be selected from the 24 internal styles.

1. Press the [SOLO STYLEPLAY] button to turn the SOLO STYLEPLAY mode on. The SINGLE FINGER mode is automatically selected when SOLO STYLEPLAY is turned on, unless the FINGERED mode is already selected.
2. Select an accompaniment style using the style selectors (see "Style Selection" on page 19). When you do this the melody voice will be automatically selected to match the selected style. You can then use the normal voice selection procedure to select a different voice, if required.
3. Set the desired tempo if necessary using the TEMPO [▲] and [▼] buttons (see "Tempo Control" on page 19).
4. Play the required chords (SINGLE FINGER or FINGERED) on the ABC section of the keyboard while playing a single-note melody line on the upper keyboard.
5. Press [START/STOP] or [INTRO/ENDING] to stop the accompaniment.
6. Press the [SOLO STYLEPLAY] button again to turn the function off.

NOTE: Some Piano ABC INTRO and ENDING patterns have their own chord progressions. If Solo Styleplay is used with these patterns, octave harmony is produced to avoid conflicting harmony and chord tones.

Harmonization Variations

It is possible to apply the harmonization type and voice from a different style to the selected style by pressing the desired style selector while holding the [SOLO STYLEPLAY] button. This makes it possible, for example, to use the solo styleplay harmonization type from the 16 BEAT 1 style when actually playing in the POP 1 style.

The Left Pedal & Solo Styleplay

If the LEFT PEDAL FUNCTION is set to SOLO STYLEPLAY in SOLO STYLEPLAY mode, harmonization of notes played on the right-hand section of the keyboard only occurs when the left pedal is pressed. This allows you to combine normal PIANO ABC type performance with SOLO STYLEPLAY as required.

The left pedal SOSTENUTO function cannot be selected while SOLO STYLEPLAY is on.

NOTE: The SOLO STYLEPLAY mode will be disengaged if the PIANO ABC FINGERED or SINGLE FINGER mode is turned off.

Disk Orchestra

Using DISK ORCHESTRA disks (one is supplied with the CVP-55/65, others are available from Yamaha), the CVP-55/CVP-65 will let you enjoy listening to automated performances, or function as your "private music tutor," allowing you to practice various parts of a piece while the others are played automatically. The CVP-65 additionally shows you which keys to play with guide lamps that light up above each key.

Automatic Performance

1. Insert the DISK ORCHESTRA disk into the CVP-55/CVP-65 disk drive with the metallic door facing the drive slot and the label side facing upward. The disk should click into place and the disk lamp will light briefly while the CVP-55/CVP-65 reads and identifies the disk.

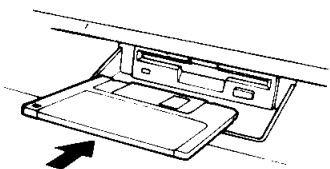

2. When the disk is inserted the [SONG SELECT], [RIGHT ON], [LEFT ON] and [ORCHESTRA ON] indicators will light, and song number "1" will be shown on the SONG NUMBER display. Use the [▲] and [▼] buttons below the display to select the desired song number. Select "ALL" if you want all songs on the disk to be played and repeated until playback is stopped.

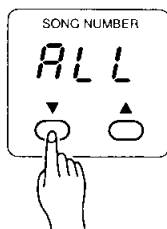

- You can also start sequential repeat playback by using the [▲] and [▼] buttons to select the song number from which playback is to begin, and then pressing the [START/STOP] button while holding the [MIDI/TRANPOSE] button.

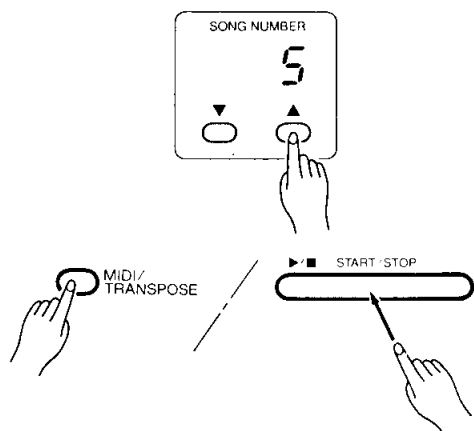

- No number will appear on the display if an appropriate DISK ORCHESTRA disk has not been properly inserted into the disk drive.

3. Start playback of the selected song by pressing either the DISK ORCHESTRA [START/STOP] button or the rhythm control [START/STOP] button. Unless "ALL" is selected, the selected song will play through to the end and playback will stop automatically. The current measure number will normally be shown on the TEMPO display during playback.

Playback can be stopped at any time by pressing the DISK ORCHESTRA [START/STOP] button or rhythm control [START/STOP] button.

- Please note that playback cannot be started while the CVP-55 or CVP-65 is searching the disk for a selected song.

- Some Disk Orchestra software does not produce a tempo display (e.g. free-tempo phrases, etc.). In this case, three lit bars appear along the bottom of the TEMPO display.

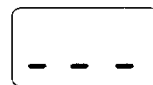

4. When you've finished with the currently loaded disk, simply press the disk drive EJECT button to remove it. You can also press the [SONG SELECT] button (its LED will go out) to return to the normal play mode without removing the disk.

CAUTION:

- NEVER eject a disk or turn the power off while:
 - 1) the disk drive lamp is on.
 - 2) the DISK ORCHESTRA function is playing.

Playing Back only Specific Parts

The [LEFT ON], [RIGHT ON] and [ORCHESTRA ON] buttons can be used to select playback of specific parts. The [LEFT ON] button turns the left-hand part on or off, the [RIGHT ON] button turns the right-hand part on or off, and the [ORCHESTRA ON] button turns the ORCHESTRA part on or off. When a part is on, the corresponding LED indicator lights. Use the [LEFT ON], [RIGHT ON] and [ORCHESTRA ON] buttons to select the parts you want to play back. You can, for example, turn off a part you want to practice on the keyboard.



Volume Control

During DISK ORCHESTRA playback use the RHYTHM volume control to adjust the volume of the drum and percussion parts, the CHORD 2 volume control adjusts the volume of the main left- and right-hand parts, the CHORD 1 volume control adjusts the volume of all other parts except the bass, and the BASS control adjusts the volume of the bass part.

Disk Orchestra

Guided Right- and Left-hand Practice (CVP-65 only)

With this feature, the CVP-65 waits for you to play the appropriate keys before playing ahead, so you can learn to play the piece at your own pace.

Press the [GUIDE] button so that its indicator lights to turn the guide mode on. The settings of the [RIGHT ON] and [LEFT ON] buttons will then determine whether the guide lamps operate for the left-hand part only, the right-hand part only, or both the right- and left-hand parts, as listed below.

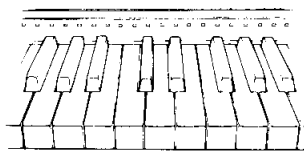

After turning [GUIDE] on ...

[LEFT ON] ON + [RIGHT ON] ON

||
Left- and right-hand guide.

[LEFT ON] ON + [RIGHT ON] OFF

||
Right-hand guide only.

[LEFT ON] OFF + [RIGHT ON] ON

||
Left-hand guide only.

When you press the [START/STOP] button to begin playback, the introduction will play automatically but then the CVP-65 will stop and wait for you to play the key(s) indicated by the guide lamps above the keyboard (see "Guide Modes" below). As you play the indicated keys, the piece will continue, pausing until you play the right keys each time.

As with automated performance, the song will stop automatically when the end is reached, or it can be stopped at any time by pressing the [START/STOP] button.

- Disk Orchestra playback tempo can be set to any desired value after a song has been selected by using the TEMPO [▲] and [▼] buttons.
- The current measure number will be shown on the TEMPO display after DOC playback has begun. The measure number may not exactly match that shown on the sheet music, however.
- The positions of the guide lamps do not change if the transpose function is used to transpose the pitch of the keyboard.
- If the guide lamps flashing above the CVP-65 keyboard distract you, or you want to try playing along without them, simply press the [RIGHT ON] button while holding the [MIDI/TRANSCOPE] button. Repeat to turn the guide lamps back on.

CVP-65 Guide Modes

The CVP-65 has two guide modes which can be selected as follows:

Normal wait: This mode is automatically selected when the CVP-65 power is turned on. It can also be selected by pressing the A-1 key while holding the [GUIDE] button.

In the normal wait mode the CVP-65 will wait until the key(s) indicated by the guide lamp(s) is pressed before proceeding to the next note.

Delayed Wait: This mode can be selected by pressing the B-1 key while holding the [GUIDE] button.

In the delayed wait mode the CVP-65 will play ahead for 8 quarter notes and then wait until any of the keys indicated by the guide lamps are pressed.

Phrase Repeat

Use this function if you want to practice a specific phrase within a song.

1. Select the desired song as described in "Automatic Performance," above.
2. Press the [PHRASE REPEAT] button (its LED indicator will light). When this is done the SONG NUMBER display will function as the phrase number display. Use the [▲] and [▼] buttons below the display to select the desired phrase number (refer to the DISK ORCHESTRA COLLECTION book that comes with the DISK ORCHESTRA COLLECTION disk for phrase locations).

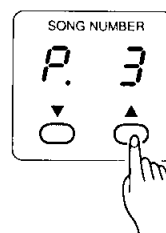
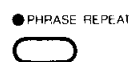

3. Press the [START/STOP] button to begin playback of the selected phrase. Phrase playback will repeat until the [START/STOP] button is pressed a second time.

A-B Repeat

This function allows you to specify any section of a DISK ORCHESTRA song for continuous repeat playback.

While the song is playing, hold the [MIDI TRANSCOPE] button and press the [PHRASE REPEAT] button once at the beginning of the section to be repeated and again at the end of the section to be repeated.



Performance Memory

To begin repeat playback first activate the A-B Repeat mode by selecting phrase number "0" ("A-b" will appear on the SONG NUMBER display), then start and stop playback in the normal way.

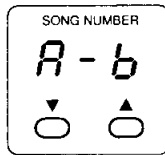

- The specified A-B repeat points will be erased when a new song number is selected.

Pause

Press the [|| PAUSE] button to temporarily stop DISK ORCHESTRA playback. Press the [|| PAUSE] button again to resume playback from the same point.



- The [|| PAUSE] button can not be used in the guide mode.

Rewind and fast Forward

During DISK ORCHESTRA operation the [◀ REW] and [▶ FF] buttons function as follows:

- While playback is stopped or paused the [◀ REW] and [▶ FF] buttons can be used to step backward or forward through the song a measure at a time.
- The [◀ REW] and [▶ FF] buttons cannot be used in the guide mode.
- During playback the [▶ FF] button causes fast playback for as long as the button is held.



Pedal Pause/Next Phrase

If the left pedal is set for START/STOP operation using the [LEFT PEDAL FUNCTION] button, it functions as a pause/next phrase control during DISK ORCHESTRA playback: press once to pause, and again to continue from the beginning of the next phrase. There may be a slight delay after the pedal is pressed to "cue" to the beginning of the next phrase.

- The pedal pause/next phrase function will not operate if the guide, phrase repeat, or all songs repeat modes are active.

DISK ORCHESTRA COLLECTION Disk Copy

The orchestra parts of songs from DISK ORCHESTRA COLLECTION disks — the disk supplied with the CVP-55/65 and others available from Yamaha — can be copied to separate disks by following the "Disk Orchestra Collection Song Copy" instructions given on page 31 of the "Disk Control" section. Data copied in this way can be played back and manipulated via the Performance Memory (page 28).

The CVP-55 and CVP-65 feature a built-in "sequencer" which can be used to independently record up to ten separate parts of a single musical composition. The Performance Memory has three RECORD and three PLAY BACK buttons, corresponding to track 1, track 2, and tracks 3 through 10. The music data that you record is stored on a 3.5" floppy disk loaded into the Clavinova's disk drive unit. Before you can record, however, you must "format" a new disk, as described on page 30.

Recording

1. If you haven't already done so, make sure that a properly formatted disk is loaded into the Clavinova disk drive (see page 30), and that the disk's write protect tab is set to the "write" position (tab closed).

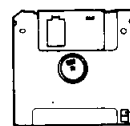

Write Protect tab

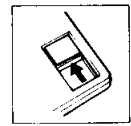

Write Protect OFF

2. Select a SONG NUMBER between 1 and 60 for the piece you are about to record (up to 60 different songs, each with a different song number, can be recorded on a single disk). Make sure the song number you select has not already been used for a song previously recorded on the disk you are using.

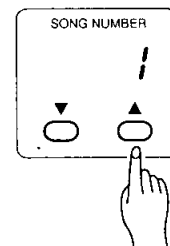

3. Only one track can be recorded at a time. If you press [RECORD 1] you will record on track number 1. If you press [RECORD 2] you will record on track number 2. If you press [RECORD 3-10], you can choose to record on track 3, 4, 5, 6, 7, 8, 9, or 10 by selecting the desired track number using the [▲] and [▼] buttons below the SONG NUMBER display while holding the [RECORD 3-10] button (the selected track number will appear on the SONG NUMBER display). When a record track has been selected the corresponding LED will light and the metronome will sound at the currently selected tempo.

If you don't want to hear the metronome or rhythm sound, turn the RHYTHM volume control all the way down.



Performance Memory

- The guide lamps above the CVP-65 keyboard provide a recorded-track display while the [RECORD 3—10] button is held. The guide lamps above the keys D#6 through A#6 correspond to tracks 3 through 10, and C7 is the rhythm track (not independently recordable). When a guide lamp is on, the corresponding track contains recorded data. Guide lamps that are off represent empty tracks.

4. Set up all necessary performance features as required: voice, voice mode (normal, dual, or split), rhythm style, tempo, ABC, solo styleplay, left pedal function, etc. Please note that split point changes must be made before a [RECORD] button is pressed.

- To record with ABC press the [RECORD 1] button and then engage an ABC mode. The track 3-10 record LED will light automatically in addition to the track 1 LED, and the ABC sound will be recorded on tracks 3 through 9 while what you play on the keyboard will be recorded on track 1.
- If you also select solo styleplay, the track 2 LED will automatically light and the solo styleplay sound will be recorded on tracks 2 and 10 while the ABC sound is recorded on tracks 3 through 9.
- If the tracks on which you intend to record ABC or solo styleplay data already contain a different type of data, "y/n" will appear on the SONG NUMBER display when you press a track button to initiate recording with the ABC or solo styleplay features. The track LED will light when you press "y."
- If you record with both the ABC single finger mode and the split mode engaged, the left hand notes you play will be heard while recording but will not be recorded by the performance memory.

5. The synchronized start mode is automatically selected when a [RECORD] button is pressed, so recording will begin automatically as soon as any key on the keyboard is pressed or the [START/STOP] button is pressed (see page 22 for the various synchro start modes). The current measure number is shown on the TEMPO display as you record.

Changes in the following parameters will be recorded in addition to notes you play:

- Voice
- Style
- Fill In
- Style Variation
- Intro/Ending
- Tempo (initial tempo and subsequent tempo changes)
- Piano ABC Mode
- Solo Styleplay
- Dual/Split Mode
- Damper, Sostenuto and Soft Pedal
- Rhythm, Chord 1, Chord 2, Bass, and Keyboard Volume ([MIDI/TRANPOSE] + BASS volume)
- Expression
- Pitch Bend
- Vibrato
- Reverb
- Split Position

NOTE: The initial values of the above parameters can be changed for each track by engaging the record mode for the desired track, changing the parameters as required, and then disengaging the record mode without actually recording. In this case the RHYTHM, CHORD 1, CHORD 2, and BASS volume settings can only be decreased. Also note that the tempo, reverb, style, style variation, fill-in, and intro settings are common to all tracks and cannot be set independently for different tracks.

6. Press the RECORD button a second time, or the STOP button to stop recording. Recording will stop automatically if the memory capacity is reached (see "Memory Capacity and Display" below).

Recording a New Track

When you've finished recording the first track, you can simply play it back as described in "playback," below, or record a new track. To record a new track, press a [RECORD] button other than the one you used to record the previous track, and start recording (if you record on a track that has already been recorded, the previous material will be erased and the new material will be recorded in its place).

If you press the [PLAY BACK] button of the previously recorded track, you'll be able to record the new track while listening to the previously recorded track.

Punch-in Recording

After pressing a [RECORD] button it is possible to specify a measure number by using the [▶▶ FF] button or by entering three digits via the VOICE selectors while holding the [MIDI/TRANPOSE] button. The specified measure number will appear on the TEMPO display and playback will begin from that measure. Recording will start automatically when a key is played, and all previous material from that point until the end of the recording will be replaced with the new material.

- Punch-in recording can not be used if the following types of data are recorded in the Performance Memory:
 1. Solo Styleplay recorded on track 1.
 2. DOC copy data.

Multi-timbre Recording via MIDI

Data from an external MIDI device such as a sequencer or music computer can also be recorded in the CVP-55/65 Performance Memory by activating the "Multi-timbre" mode.

The Multi-timbre mode is activated by pressing the [RECORD 1] button while holding the [MIDI/TRANPOSE] button. In this mode all tracks (1 through 10, and 15) can be recorded at the same time via the correspondingly numbered MIDI channels. That is, MIDI data received on channel 1 will be recorded on track 1, data received via channel 2 will be recorded on track 2, etc.

- Previous data on all tracks will be erased when new data is recorded in the Multi-timbre mode.

Playback

1. Make sure that the disk containing the song you wish to play is properly loaded in the disk drive and that the [SONG SELECT] button LED is lit. Use the [▲] and [▼] buttons below the SONG NUMBER display to select the song number (1—60) you wish to play. The LED indicators for tracks that contain recorded data will light.

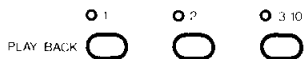

2. If you want to mute certain tracks (i.e. cancel playback of certain tracks) press the [PLAY BACK] button of the track or tracks you want to mute so that the corresponding play indicators go out. The [PLAY BACK 3-10] button determines the playback status of all material on tracks 3 through 10.

- The guide lamps above the CVP-65 keyboard provide a recorded-track display while the [PLAY BACK 3-10] button is held. The guide lamps above the keys D#6 through A#6 correspond to tracks 3 through 10, and C7 is the rhythm track. When a guide lamp is on, the corresponding track contains recorded data. Guide lamps that are off represent empty tracks. Playback of any of these tracks can be cancelled while the [PLAY BACK] button is held by pressing the corresponding key on the keyboard (the guide lamp will flash).

3. Playback of the selected tracks begins as soon as the [START/STOP] button is pressed. Playback can also be started by pressing the [INTRO/ENDING] button and then the [START/STOP] button — in this case playback will begin with an introduction even if the [INTRO/ENDING] button was not used to begin recording.

4. Play along if you like on the keyboard — using any of the Clavinova's voices.

5. Press the [START/STOP] or [INTRO/ENDING] button to stop playback. Playback will stop automatically when the end of the recording is reached. Playback will also stop if a RECORD button is pressed during playback.

- The A-B Repeat function can be used for performance memory playback if the [PHRASE REPEAT] button is turned on (see "A-B Repeat" on page 26. Repeat playback of all songs, beginning from a specified song number if desired, is also possible (see page 25 of the Disk Orchestra section)

- The CVP-65 guide lamps will light during playback, according to the data contained in PLAY BACK tracks 1 and 2. The guide lamps can be turned off by pressing the [RIGHT ON] button while holding the [MIDI/TRANSCOPE] button.

The Chord Sequencer

The CVP-55/65 CHORD SEQUENCER provides a convenient way to enter chord sequences chord by chord.

1. Press the [CHORD SEQUENCER] button. The ABC FINGERED mode will be automatically selected — switch to the SINGLE FINGER mode if you prefer.



- The following parameters are recorded by the chord sequencer:

- Style no.
- Fill-in, Intro, Ending
- Rhythm, Chord 1, Chord 2, and Bass volume

2. Play and hold a chord on the left-hand section of the keyboard, and press the [♪] key (look for the "♪" symbol above the B6 key) or the [♩] key (C7) to enter the chord for a quarter note or whole note, respectively.

Continue entering chords in this manner until your sequence is complete.

- If you only specify note lengths without entering any chords from the beginning of the sequence, the sequence will contain the rhythm pattern only. It is also possible to produce rhythm solos, bass solos, or blanks during a sequence by turning the volume of the parts to be muted all the way down.



- You can move one step backward by pressing the [◀] key (A6).
- The number of the current measure is displayed on the TEMPO display, while the BEAT indicator represents the current beat within that measure.

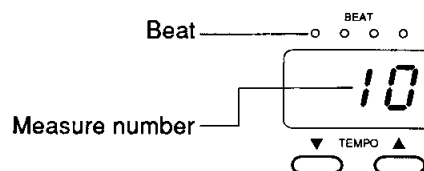

3. When all the required chords have been entered, press the [CHORD SEQUENCER] button to transfer the recorded sequence data to tracks 3 through 9 of the performance memory (i.e. the ABC tracks).



- The chord sequencer data now resides in performance memory tracks 3 through 9, and can be played back in the normal way. You can also record over individual tracks of the sequence and replace them with original material if you like by using the standard performance memory track selection and record procedure.

Performance Memory

Erasing the Tracks

Individual tracks can be completely erased by starting and stopping recording without actually playing or changing any parameters. All tracks can be erased at the same time by selecting ABC and SOLO STYLEPLAY, then starting and stopping recording as described above.

Memory Capacity and Display

A single disk can record a total of approximately 700 kilobytes (a kilobyte is 1,024 bytes) of data — sufficient for many long and complicated performances. In terms of notes, approximately 50,000 notes can be recorded continuously if no other Clavinova functions are used. The remaining memory capacity is shown in kilobytes on the SONG NUMBER display immediately while a [RECORD] button is pressed.

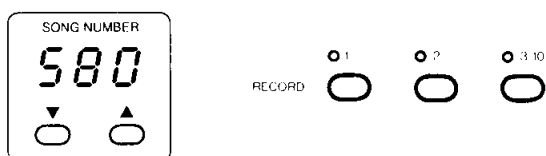

- The Clavinova has enough internal RAM memory to allow recording for a while even if a disk is not loaded. If accidentally record without loading a disk, make sure you use the COPY function (described later) to copy the recorded data to disk if you want to keep the recorded data (the internal RAM memory is not backed up). This is necessary because the internal RAM memory is cleared automatically when a new performance disk is loaded.

Disk Control

Formatting a New Disk

The Clavinova uses only 3.5" 2DD floppy disks. We recommend that you use Yamaha 2DD disks. Before you can use a new disk for recording, the disk must be "formatted" so that the Clavinova can recognize it and correctly write the music data onto it.

1. Insert a new blank disk. Make sure that the disk's write protect tab is set to the "write" position (tab closed), and insert the new disk into the disc drive unit with the metallic door facing the drive slot and the label side of the disk facing upward. The disk should click securely into place, and the disk drive lamp should light briefly.

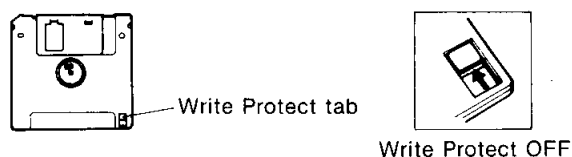

- "For" will appear on the SONG NUMBER display to indicate that a blank (unformatted) disk is loaded in the drive.

2. Press the DISK CONTROL [FORMAT] button. The [FORMAT] button LED will flash.

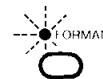

3. Use the SONG NUMBER [▲] and [▼] buttons to select either "Y" (YES) or "n" (NO) on the display. "Y" if you intend to execute the format operation or "n" if you wish to cancel the operation. This step is necessary because formatting completely erases any data that is already on the disk — make sure that the disk you're about to format does not contain any important data!

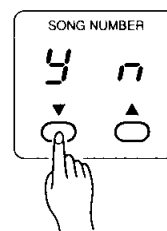

4. Press the [FORMAT] button again and formatting will begin. The number of each "track" on the disk will be shown on the display as the format process continues. When formatting is complete (the display will show "1"), you can go ahead and record using the performance memory, or use the COPY function (below) to copy songs to the newly formatted disk, or ABC patterns from the Style Disk to the newly formatted disk when using the CVP-65.

- When using the floppy disk format function, a write protect error (Er 2) will be generated with the following three disk types regardless of the disk's write protect status. This has been done to ensure that the music software cannot be accidentally erased.

1. YAMAHA Disklavier software (PianoSoft).
2. Disks formatted on the YAMAHA Disklavier.
3. Clavinova software (Disk Orchestra Collection).

Copying Songs

Song data can be "backed up" by copying to a new song number or a different disk, as follows:

NOTE: Copying can only be carried out one song at a time — i.e. the entire contents of a disk containing several songs cannot be copied in one operation.

1. Make sure the [SONG SELECT] LED is on (except when copying from the Style Disk using the CVP-65, in which case it must be off), and use the [▲] and [▼] buttons below the SONG NUMBER display to select the number of the song you wish to copy.
2. Press the [COPY] button. The [COPY] button LED will flash.



3. Use the [▲] and [▼] buttons below the SONG NUMBER display to select the song number you wish to copy to (i.e. the destination song number). If you select a song number that already contains data, that data will be overwritten by the new song data. If you select a song number greater than 60, the copy will be made to a different disk.

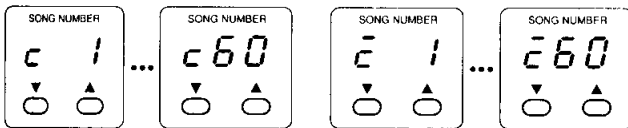

Copy to same disk

Copy to different disk (Song number greater than 60)

4. Press the [COPY] button again to begin the actual copy operation (the [COPY] LED will light continuously during the copy operation).

If you chose to copy to a different disk, you may have to exchange the source and destination disks a few times if the song being copied is long and complex. In this case, the Clavinova will prompt you to insert the source and destination disks with the following displays:

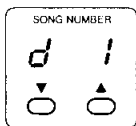

Insert source disk.

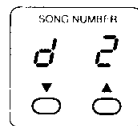

Insert destination disk.

- If you copy to a song number that already contains data, or to another disk, the Clavinova will ask you to confirm the copy operation. Use the SONG NUMBER [▲] and [▼] buttons to select either "Y" (YES) or "n" (NO) on the display. "Y" if you intend to execute the copy operation or "n" if you wish to cancel the operation. The copy operation will begin automatically if you select "Y."

- The [COPY] LED will go out when the copy operation is finished and the source song number will appear on the display.

- The copy operation can be aborted while the [COPY] button LED is flashing (not while it is lit) by pressing the [START/STOP] button.

Disk Orchestra Song Copy

This function allows you to copy the orchestra parts of one song from a DISK ORCHESTRA COLLECTION disk to a different disk.

The disk must be properly formatted, and all previous data contained on the disk will be erased.

1. Insert the DISK ORCHESTRA COLLECTION disk in the drive, then use the [▲] and [▼] buttons below the SONG NUMBER display to select the number of the song you wish to copy.
2. Press the [COPY] button. The [COPY] button LED will flash.
3. Use the [▲] and [▼] buttons below the SONG NUMBER display to select a song number greater than 60 so that the copy will be made to a different disk.

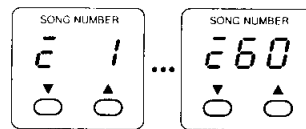

Copy to different disk (Song number greater than 60)

4. Press the [COPY] button again. "d 2" will appear on the display — eject the DISK ORCHESTRA COLLECTION disk and insert the newly formatted disk in the drive.
5. "Y n" will appear on the display. Use the SONG NUMBER [▲] and [▼] buttons to select either "Y" (YES) or "n" (NO) on the display. "Y" if you intend to execute the copy operation or "n" if you wish to cancel the operation. The copy operation will begin automatically if you select "Y."

You may have to exchange the source and destination disks a few times. The Clavinova will prompt you to insert the source and destination disks with the following displays:

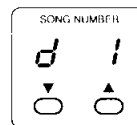

Insert DISK ORCHESTRA COLLECTION disk.

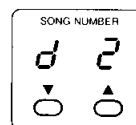

Insert newly formatted disk.

The [COPY] LED will go out when the copy operation is finished and the DOC song number will appear on the display.

Disk Control

NOTE: The Disk Orchestra Collection data will be copied to performance memory tracks 3 through 10, leaving tracks 1 and 2 blank. You can record new data on these tracks using the normal performance memory record procedure.

NOTE: Other performance data can be recorded to the same disk as long as it is copied to a different song number.

NOTE: Disk Orchestra Collection data copied as described above cannot be copied to a different disk — although it can be copied to a different song number on the same disk.

Deleting a Song

You can delete any song from a loaded disk as follows:

1. Press the [COPY] button while holding the [MIDI/TRANSCOPE] button. The [COPY] LED will flash.

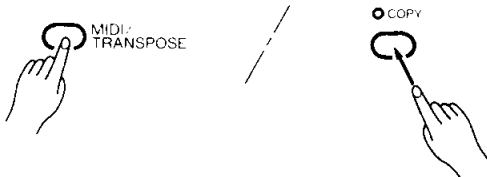

2. Use the SONG NUMBER [▲] and [▼] buttons to select the song number you wish to delete.
3. Press the [COPY] button a second time to actually delete the selected song.

Error Messages

If an error related to the disk occurs, one of the following messages may appear. If this happens, try the operation that caused the error message again. If the error persists, you may be attempting to use a write-protected disk, a disk that has not been properly formatted, or the disk itself may be at fault. If all else fails, try a different disk. If this doesn't clear up the problem, contact your Yamaha dealer.

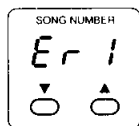

Disk read or write error
(e.g. unformatted disk)

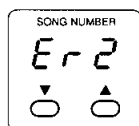

Disk write-protected.

NOTE: In the case of the CVP-65, data from a Style Disk cannot be copied to a disk that contains Performance Memory or Disk Orchestra Song Copy data. The reverse is also true: Performance Memory and Disk Orchestra Song data cannot be copied to a disk containing data copied from the Style Disk.

MIDI Functions

A Brief Introduction to MIDI

MIDI, the Musical Instrument Digital Interface, is a world-standard communication interface that allows MIDI-compatible musical instruments and equipment to share musical information and control one another. This makes it possible to create "systems" of MIDI instruments and equipment that offer far greater versatility and control than is available with isolated instruments.

For example, most MIDI keyboards (including the Clavinova, of course) transmit note and velocity (touch response) information via the MIDI OUT connector whenever a note is played on the keyboard. If the MIDI OUT connector is connected to the MIDI IN connector of a second keyboard or a tone generator, the second keyboard or tone generator will respond precisely to notes played on the original transmitting keyboard. The result is that you can effectively play two instruments at once, providing thick multi-instrument sounds.

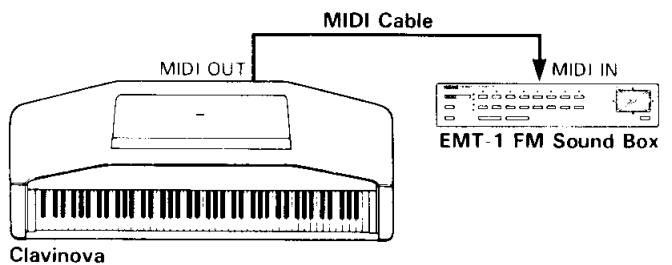

This same type of musical information transfer is used for MIDI sequence recording. A sequence recorder such as the Yamaha DRC-20 Disk Recorder or EMQ-1 Memory Box can be used to "record" MIDI data received from a Clavinova, for example. When the recorded data is played back, the Clavinova automatically "plays" the recorded performance in precise detail.

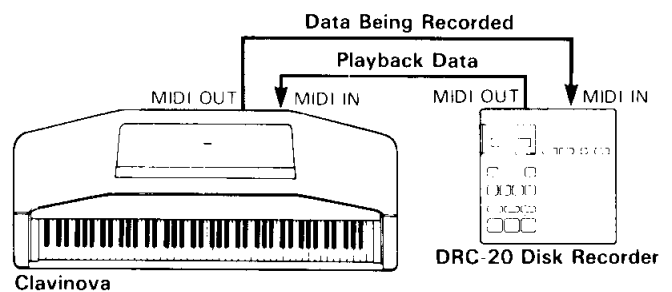

The examples given above really only scratch the surface. MIDI can do much, much more. The CVP-55/CVP-65 offers a number of MIDI functions that allow them to be used in fairly sophisticated MIDI systems.

Note: Always use a high-quality MIDI cable to connect MIDI OUT to MIDI IN terminals. Never use MIDI cables longer than about 15 meters, since cables longer than this can pick up noise which can cause data errors.

Accessing the CVP-55/CVP-65 MIDI Functions

All of the CVP-55/CVP-65 MIDI functions are accessed by pressing the appropriate VOICE selector while holding the [MIDI/TRANSCOPE] button. The MIDI functions accessed by the various VOICE selectors are shown in the following chart:

Function	Selector
1. Send Channel Select	PIANO
2. Receive Channel Select	CLAVINOVA TONE
3. Local ON/OFF	E. PIANO
4. Program Change ON/OFF	HARPSI
5. Control Change ON/OFF	VIBES
6. Multi-Timbre Mode ON/OFF	GUITAR
7. Split Send Mode	STRINGS
8. MIDI Clock Select	ORGAN
9. Panel Data Transmit	CHOIR

Send and Receive Channel Select

In any MIDI control setup, the MIDI channels of the transmitting and receiving equipment must be matched for proper data transfer (there are 16 MIDI channels). An "OMNI ON" receive mode is also available, which allows reception on all 16 MIDI channels. In the OMNI ON mode it is not necessary to match the receive channel of the receiving device to the transmit channel of the transmitting device.

1. Hold [MIDI/TRANSCOPE] and press [PIANO] to set the send channel or [CLAVINOVA TONE] to set the receive channel.
2. Use TEMPO [▲] and [▼] buttons to select the desired channel (the selected channel number is shown on the TEMPO display — the OMNI ON receive mode is indicated by "ALL" on the display).

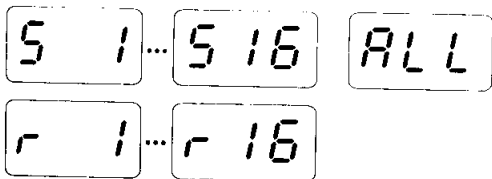

3. Release [MIDI/TRANSCOPE].

Note: When the power is initially turned ON, MIDI receive is set to the OMNI ON mode and the transmit channel is set to 1.

Local Control ON/OFF

"Local Control" refers to the fact that, normally, the Clavinova keyboard controls its internal tone generator, allowing the internal voices to be played directly from the keyboard. This situation is "Local Control ON" since the internal tone generator is controlled locally by its own keyboard.

Local control can be turned off, however, so that the Clavinova keyboard does not play the internal voices, but the appropriate MIDI information is still transmitted via the MIDI OUT connector when notes are played on the keyboard. At the same time, the internal tone generator responds to MIDI information received via the MIDI IN connector. This means that while an external MIDI recorder such as the Yamaha DRC-20 Disk Recorder, for example, plays the Clavinova's internal voices, an external tone generator such as the EMT-1 can be played from the Clavinova keyboard. Local Control is automatically turned ON when the power is initially turned on.

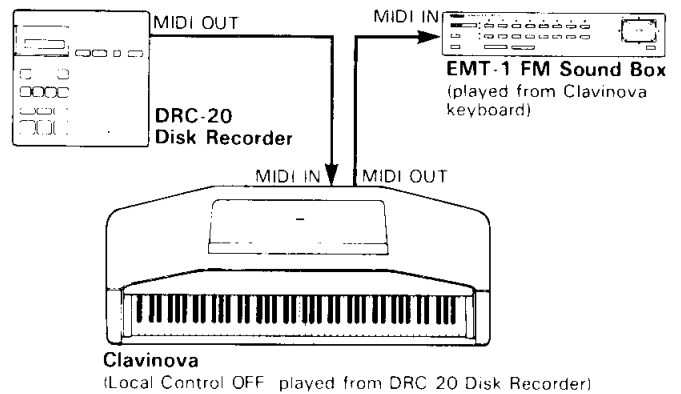

1. Hold [MIDI/TRANSCOPE] and press [E. PIANO].
[E. PIANO] LED ON = local control OFF.
[E. PIANO] LED OFF = local control ON.
2. Release [MIDI/TRANSCOPE].

Program Change ON/OFF

Normally the Clavinova will respond to MIDI program change numbers received from an external keyboard or other MIDI device, causing the correspondingly numbered Clavinova voice to be selected. The Clavinova will normally also send a MIDI program change number whenever one of its voices is selected, causing the correspondingly numbered voice or program to be selected on the external MIDI device if the device is set up to receive and respond to MIDI program change numbers.

This function makes it possible to cancel program change number reception and transmission so that voices can be selected on the Clavinova without affecting the external MIDI device, and vice versa. Program Change is automatically turned on when the power is initially turned on.

MIDI Functions

1. Hold [MIDI/TRANSDPOSE] and press [HARPSI].
[HARPSI] LED ON = program change reception/
transmission OFF.
[HARPSI] LED OFF = program change reception/
transmission ON.
2. Release [MIDI/TRANSDPOSE].

Control Change ON/OFF

Normally the Clavinova will respond to MIDI control change data received from an external MIDI device or keyboard, causing the selected Clavinova voice to be affected by pedal and other "control" settings received from the controlling device. The Clavinova also transmits MIDI control change information when either of its pedals are operated.

This function makes it possible to cancel control change data reception and transmission if you do not want the Clavinova voices to be affected by control change data received from an external device or vice versa. Control Change is automatically turned on when the power is initially turned on.

1. Hold [MIDI/TRANSDPOSE] and press [VIBES].
[VIBES] LED ON = control change reception/transmission OFF.
[VIBES] LED OFF = control change reception/transmission ON.
2. Release [MIDI/TRANSDPOSE]

The Multi-Timbre Mode

The Multi-Timbre mode is a special mode in which the Clavinova voices can be independently controlled on different MIDI channel numbers (1 through 10 and 15) by an external MIDI device such as the Yamaha DRC-20 Disk Recorder. The Multi-Timbre mode is off when the power is initially turned on.

The Multi-Timbre mode can be activated as follows:

1. Hold [MIDI/TRANSDPOSE] and press [GUITAR].
[GUITAR] LED ON = Multi-Timbre mode ON.
[GUITAR] LED OFF = Multi-Timbre mode OFF.
2. Release [MIDI/TRANSDPOSE].

The CVP-55/CVP-65's MIDI channel 15 controls rhythms only. The note assignments for the various rhythm instruments are given below:

RHYTHM INSTRUMENT NOTE ASSIGNMENTS

Note (MIDI Note No.)	Instrument
A1 (45)	CYMBAL DAMP
F#2 (54)	BRUSH ROLL
G#2 (56)	HI-HAT CLOSED HEAVY
A#2 (58)	CRASH CYMBAL LIGHT
B2 (59)	BASS DRUM LIGHT
C3 (60)	SNARE DRUM + RIM HEAVY
C#3 (61)	RIDE CYMBAL CUP
D3 (62)	SNARE DRUM + RIM LIGHT
F3 (65)	BASS DRUM
F#3 (66)	RIM SHOT
G3 (67)	SNARE DRUM HEAVY
G#3 (68)	BRUSH SHOT
A3 (69)	SNARE DRUM LIGHT
A#3 (70)	HI-HAT PEDAL
B3 (71)	SNARE DRUM ECHO
C4 (72)	TOM 4
C#4 (73)	HI-HAT CLOSED
D4 (74)	TOM 3
D#4 (75)	HI-HAT OPEN
E4 (76)	TOM 2
F4 (77)	TOM 1
F#4 (78)	RIDE CYMBAL
G#4 (80)	CRASH CYMBAL
C5 (84)	CONGA LOW
C#5 (85)	CABASA
D5 (86)	CONGA HIGH
D#5 (87)	METRONOME
E5 (88)	BONGO
F5 (89)	TIMBALE LOW
F#5 (90)	CLAVES
G5 (91)	TIMBALE HIGH
G#5 (92)	CASTANETS
A5 (93)	CUICA LOW
A#5 (94)	COWBELL
B5 (95)	CUICA HIGH
C6 (96)	HAND CLAPS
C#6 (97)	AGOGO LOW
D#6 (99)	AGOGO HIGH
E6 (100)	BONGO LOW
F#6 (102)	TAMBOURINE
G#6 (104)	TRIANGLE CLOSED
A#6 (106)	TRIANGLE OPEN

The Split Send Mode

In the split send mode notes played on the left-hand section of the keyboard (to the left of and including the split point key — see “Changing the Split Point” on page 15) are transmitted on MIDI channel 2, while the upper keyboard section transmits on the MIDI channel set using the Send Channel Select function described earlier. In this mode the left- and right-hand sections of the keyboard can be used to play separate external keyboards or tone generators set to receive on the appropriate channels. The Split Send Mode is automatically turned off when the power is initially turned on.

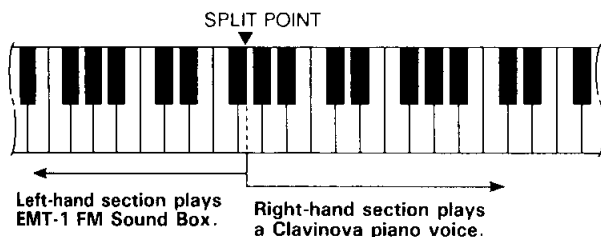
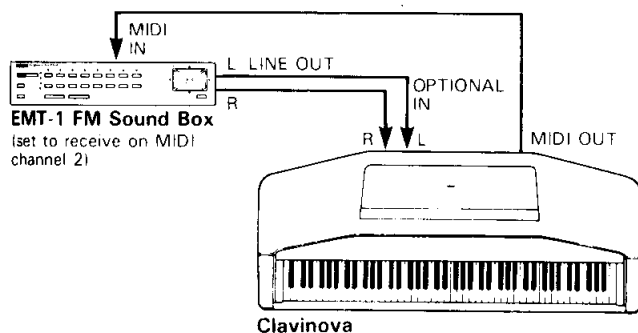

1. Hold [MIDI/TRANPOSE] and press [STRINGS].
[STRINGS] LED ON = Split Send Mode ON.
[STRINGS] LED OFF = Split Send Mode OFF.
2. Release [MIDI/TRANPOSE].

MIDI Clock Select

This function determines whether the CVP-55/CVP-65's rhythm and PIANO ABC timing is controlled by the CVP-55/CVP-65's own internal clock or an external MIDI clock signal received from external equipment connected to the MIDI IN connector. The Clock Mode is automatically set to INTERNAL when the power is initially turned on.

1. Hold [MIDI/TRANPOSE] and press the [ORGAN].
[ORGAN] LED ON = EXTERNAL.
[ORGAN] LED OFF = INTERNAL.
2. Release [MIDI/TRANPOSE].

NOTE: If the Clock Mode is set to EXTERNAL and a MIDI clock signal is not being received from an external source, the CVP-55/CVP-65 rhythm, PIANO ABC and other clock-dependent features will not operate.

Panel Data Send

This function causes all the current Clavinova panel settings (selected voice, etc) to be transmitted via the MIDI OUT terminal. This is particularly useful if you will be recording performances to a MIDI sequence recorder which will be used to control the Clavinova on playback. By transmitting the Clavinova panel settings and recording them on the MIDI sequence recorder prior to the actual performance data, the Clavinova will be automatically restored to the same settings when the performance is played back.

1. Hold [MIDI/TRANPOSE] and press [CHOIR].
2. Release [MIDI/TRANPOSE].

MIDI Specifications for Other Equipment

When using the Clavinova with other MIDI equipment, always refer to the MIDI specifications (implementation chart and MIDI data format) of the equipment used to ensure compatibility.

Troubleshooting

If you encounter what appears to be a malfunction, please check the following points before assuming that your Clavinova is faulty.

1. No Sound When the Power is Turned ON

Is the AC plug properly connected to an AC wall outlet? Check the AC connection carefully. Is the MASTER VOLUME control turned up to a reasonable listening level?

2. The Clavinova Reproduces Radio or TV Sound

This can occur if there is a high-power transmitter in your vicinity. Contact your Yamaha dealer.

3. Intermittent Static Noise

This is usually due to turning ON or OFF a household appliance or other electronic equipment which is fed by the same AC mains line as your Clavinova.

4. Interference Appears On Radio or TV Sets Located Near the Clavinova

The Clavinova contains digital circuitry which can generate radio-frequency noise. The solution is to move the Clavinova further away from the affected equipment, or vice versa.

5. Distorted Sound When the Clavinova is Connected to An External Amplifier/Speaker System

If the Clavinova is connected to a stereo system or instrument amplifier and the sound is distorted, reduce the setting of the Clavinova volume control to a level at which the distortion ceases.

Options & Expander Modules

OPTIONS

BC-7/BC-8 Bench

A stable, comfortable bench styled to match your Yamaha Clavinova.

HPE-5 Stereo Headphones

High-performance lightweight dynamic headphones with extra-soft ear pads.

EXPANDER MODULES

DRC-20 Disk Recorder

DOM-30 Disk Orchestra Module

These state-of-the-art Expander Modules can dramatically expand the musical scope of your Clavinova.

NOTE: Some items may not be available in certain areas.

MIDI Data Format

If you're already very familiar with MIDI, or are using a computer to control your music hardware with computer-generated MIDI messages, the data provided in this section can help you to control the Clavinova.

1. NOTE ON/OFF

Data format: [9xH] -> [kk] -> [vv]

9xH = Note ON event (x = channel number)

kk = Note number (21 ~ 108 = A-1 ~ C7)

vv = Velocity (Key ON = 1 ~ 127. Key OFF = 0)

* Note OFF event format [8xH] -> [kk] -> [vw] also recognized (reception only, vv = 0 ~ 127).

2. CONTROL CHANGE & MODE MESSAGES

Data format: [BxH] -> [cc] -> [dd]

BxH = Control event (x = channel number)

cc = Control number (or mode message number)

dd = Control value

cc	PARAMETER	dd
01H (01)	Modulation (Vibrato)	0 (OFF) ~ 127 (MAX.)
07H (07)	Volume	00000000 = -∞ 01101111 = -3 dB 01111111 = ±0 dB
0AH (10)	Pan pot	00H ~ 1FH = left 3 20H ~ 2FH = left 2 30H ~ 3FH = left 1 40H ~ 47H = center 47H ~ 4FH = voice fixed 50H ~ 5FH = right 1 60H ~ 6FH = right 2 70H ~ 7FH = right 3
0BH (11)	Expression	00000000 = -∞ 01101111 = -3 dB 01111111 = ±0 dB
40H (64)	Damper pedal	0 ~ 3FH = OFF; 40H ~ 7FH = ON
42H (66)	Sostenuto pedal	0 ~ 3FH = OFF; 40H ~ 7FH = ON
43H (67)	Soft pedal	0 ~ 3FH = OFF; 40H ~ 7FH = ON
5BH (85)	Reverb Depth	00H ~ 7FH
79H (121)	Reset all controllers	0
7AH (122)	Local ON/OFF	0 = OFF; 7FH = ON
7BH (123)	All notes OFF	0
7CH (124)	OMNI OFF/All notes OFF	0
7DH (125)	OMNI ON/All notes OFF	0

* 0AH, 7AH, 7BH, 7CH and 7DH are receive only.

3. PROGRAM CHANGE

Data format: [CxH] -> [dd]

CxH = program event (x = channel number)
dd = Program number

Panel Voices

dd VOICE
00H PIANO
01H CLAVINOVA TONE
02H E.PIANO
03H HARPSICHORD
04H VIBES
05H GUITAR
06H STRINGS
07H ORGAN
08H CHOIR
09H UPRIGHT BASS
0AH ELEC BASS
0BH DRUMS

Voices 13 — 53

dd VOICE
0CH BRASS
0DH POP BRASS
0EH TRUMPET
0FH MUTE TRUMPET
10H HORN
11H SAX
12H SAX SOFT
13H CLARINET
14H OBOE
15H FLUTE
16H ACCORDION
17H HARMONICA
18H STRINGS SOFT
19H VIOLIN
1AH VIOLIN HARD
1BH FULL ORGAN
1CH JAZZ ORGAN
1DH SYNTH BRASS
1EH SYNTH WOOD
1FH SYNTH STRINGS
20H SYNTH CHOIR
21H PIANO BRIGHT
22H PIANO SOFT
23H E. PIANO DX
24H SYNTH CRYSTAL
25H CELESTA
26H MARIMBA
27H FOLK GUITAR
28H JAZZ GUITAR 1
29H JAZZ GUITAR 2
2AH ROCK GUITAR 1
2BH ROCK GUITAR 2
2CH MUTE GUITAR
2DH BANJO
2EH PIZZICATO
2FH HARP
30H UPRIGHT BASS SOFT
31H ELEC BASS SOFT
32H ELEC BASS HEAVY
33H SYNTH BASS
34H TIMPANI

* No voice change is made when dd > 34H.

4. PITCH BENDER

Data format: [ExH] -> [ccH] -> [ddH]

ExH = Bender event
cc = Least significant byte
dd = Most significant byte

	MSB	LSB
MAX:	01111111 01111110 01111101	01111110 01111100 01111010
Center:	01000001 01000000 00111111	00000010 00000000 00000000
MIN:	00000001 00000000	00000000 00000000

5. SYSTEM REALTIME MESSAGES

Active Sensing (FEH)

Transmitted every 200 milliseconds. If no data received for more than 400 milliseconds after FEH, a NOTE OFF occurs.

Timing Clock (F8H)

Start (FAH)

Stop (FCH)

6. SYSTEM EXCLUSIVE MESSAGES

(1) Clavinova Messages

Data Format: [F0H] -> [43H] -> [73H] -> [2BH or 2AH] -> [nn] -> [F7H]

43H = YAMAHA ID

73H = CLAVINOVA ID

2BH = CVP-65 ID, 2AH = CVP-55 ID

nn = Substatus

nn SEND/RECEIVE DATA

02H Internal clock (receive only)

03H External MIDI clock (receive only)

13H Multi-Timbre mode OFF

15H Multi-Timbre mode ON

7nH Receive channel change (receive only)

(2) Special Messages-1

Data Format: [F0H] -> [43H] -> [73H] -> [2BH or 2AH] -> [11H] -> [0xH] -> [cc] -> [dd] -> [F7H]

43H = YAMAHA ID

73H = CLAVINOVA ID

2BH = CVP-65 ID, 2AH = CVP-55 ID

11H = Clavinova special control code

0xH = MIDI channel number

cc = Control number

dd = Control value

cc SEND/RECEIVE DATA dd

08H DUAL/SPLIT Balance

00H = lower max.

7FH = upper max.

10H ABC Mode

00H = OFF

01H = ABC Single Finger

02H = ABC Fingered

03H = Full-Keyboard ABC

11H Rhythm Variation

00H = OFF

01H = Variation ON

MIDI Data Format

12H	Fill In Switch Event	00H = Fill to normal OFF event 01H = Fill to normal ON event 02H = Fill to variation ON event 03H = Fill to variation OFF event
13H	Intro/Ending Switch Event	00H = INTRO/ENDING OFF 01H = Intro mode on 02H = Ending mode on [dd] = Split key number
14H	Split	[dd] = Rhythm number
15H	Rhythm Number	[dd] = Volume value
19H	Volume	(0xH: x = 2 for BASS, x = 4 for CHORD1, x=5 for CHORD 2) [dd] = Volume value
1AH	Rhythm Volume	00H ~ 19H = Style number
21H	Solo Styleplay Number	00H ~ 3FH = OFF
22H	Solo Styleplay	40H ~ 7FH = ON
59H	Reverb	00H = OFF 01H = ROOM 02H = HALL 1 03H = HALL 2 04H = COSMIC
5AH	DUAL SPLIT Mode	00H = OFF 01H = DUAL 02H = SPLIT (upper damper) 03H = SPLIT (lower damper) 04H = SPLIT (upper/lower damper)
5CH	DUAL SPLIT Voice	[dd] = DUAL/SPLIT voice number
5DH	Pedal Function	[dd] = Function number

(2) Special Messages-2 (Tempo)

Data Format: [F0H] -> [43H] -> [73H] -> [2BH] or [2AH] -> [11H] -> [1FH] -> [cc] -> [dd] -> [F7H]

43H = YAMAHA ID

73H = CLAVINOVA ID

2BH = CVP-65 ID, 2AH = CVP-55 ID

11H = Clavinova special control code

1FH = MIDI channel number

cc = Tempo low byte

dd = Tempo high byte Tempo = dd x 128 + cc

(3) General Messages

a) Panel Dump Request (receive only)

Data Format: [F0H] -> [43H] -> [2nH] -> [7CH] -> [F7H]

Panel data is transmitted when the above data is received.

2nH = Panel dump request ("n" is channel number).

b) Panel Dump

Data Format: [F0H] -> [43H] -> [0nH] -> [7CH] ... [F7H]

0nH = Panel dump ("n" is channel number).

7CH = Format code.

• All MIDI data available for general use are given above.

Index

A

ABC Accompaniment	21, 8
A-B Repeat	26
Accompaniment volume control	12, 22
Assembly	148
AUX. OUT R and L/L+R Jacks	11

B

Bass volume	12, 22
Beat display	20

C

Center pedal	17
Chord	
1 volume	12, 22
2 volume	12, 22
fingered	21
fingerling	153
sequencer	29
single finger	21
Control change	34
Copying songs	31
Cosmic effect	16

D

Damper pedal	17
Deleting songs	32
Demonstration	13
Digital reverb effects	16
Disk control	30
copy	31
delete	32
disk orchestra song copy	31
error messages	32
format	30
Disk orchestra	25, 10
a-b repeat	26
automatic performance	25
guided practice	26
guide modes	26
pause	27
pedal pause/next phrase	27
phrase repeat	26
playing specific parts	25
rewind & fast forward	27
song copy	31, 27
volume control	25
Drum voice instruments	14
Dual mode	15, 6

E

Ending	20
Erasing performance memory tracks	30
Exclusive messages	37
Expander modules	36
Expression control	12
Expression pedal jack	11

F

Fast forward	27
Fill to normal	20
Fill to variation	20
Fill-ins	20

Fill Start 19
 Fingered accompaniment 21
 Fingered chord chart 153
 Formatting new disks 30
 Full-keyboard ABC 22

G

Guided practice 26
 Guide modes 26

H

Hall 1/2 effects 16
 Headphones jacks 11

I

Intro start 19

K

Keyboard 17
 Keyboard percussion 14
 Keyboard volume 12, 22

L

Left pedal & solo styleplay 24
 Left pedal 17
 Local control 33

M

Master volume control 12
 Memory capacity 30
 Metronome 20
 MIDI clock 35
 MIDI connectors 10
 MIDI data format 36
 MIDI functions 33
 MIDI send channel 33
 Multi-timbre mode 34
 Multi-timbre recording via MIDI 28
 Multi-timbre rhythm note assignments 35
 Music stand 11

N

Next phrase 27

O

OPTIONAL IN R and L jacks 11
 Options 36

P

Panel data transmission 35
 Pause 27
 Pedals 17
 pause 27
 Performance memory 27
 chord sequencer 29
 erasing tracks 30
 memory capacity & display 30
 multi-timbre recording 28
 playback 29
 punch-in recording 28
 recording 27
 recording a new track 28
 Phrase repeat 26

Piano ABC start modes 22
 Pitch bend control 12
 Pitch control (tuning) 18
 Pitch display 18
 Playback 29
 Polyphony 17
 Power switch 11
 Program change 33
 Punch-in recording 28

R

Recording 27
 Recording a new track 28
 Reverb depth control 16
 Rewind 27
 Rhythm 19, 7
 Rhythm volume 12, 22
 Right pedal 17
 Room effect 16

S

Single-finger accompaniment 21
 Single-finger chords 21
 Soft 17
 Solo styleplay 24, 9, 17
 Solo styleplay harmonization 24
 Sostenuito 17
 Split mode 15, 6
 Split point 15, 22
 Split send mode 35
 Start/stop 19, 17
 Straight start 19
 Style Disk 23
 auto load 24
 loading 23
 pattern list 23
 Style selection 19
 Suggested tempo list 19
 Synchronized start 20

T

Tempo control 19
 Tempo display 19, 13, 15, 16
 Touch sensitivity 18
 Transposition 18
 Troubleshooting 36
 Tuning 18

V

Vibrato control 12
 Voice list 14
 Voice selection 13, 6
 Voltage selector 4
 Volume control 12, 22
 bass volume 12, 22
 chord 1/2 volume 12, 22
 keyboard volume 12, 22
 master volume 12
 rhythm volume 12, 22

1

- Main keyboard unit
- Keyboard
- Clavier
- Unidad principal de teclado

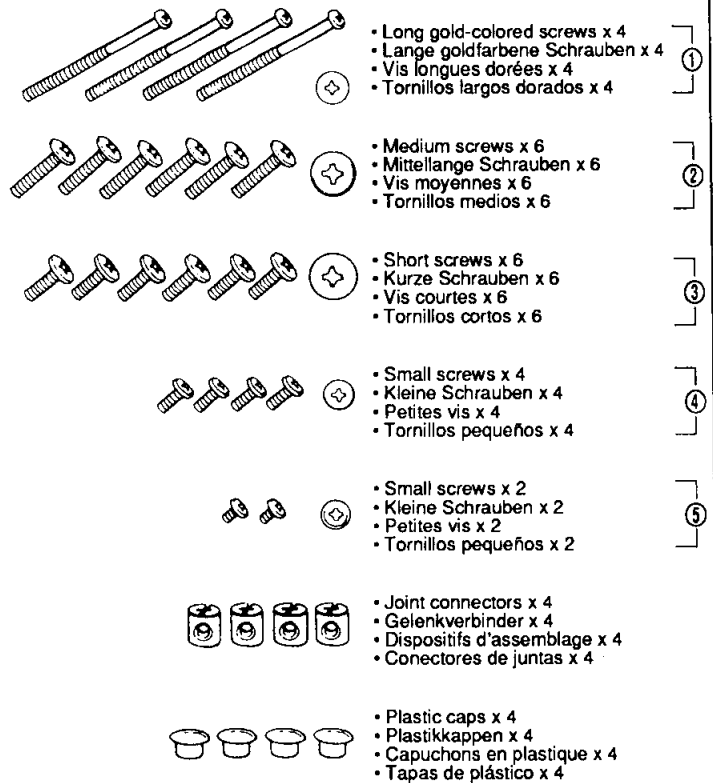
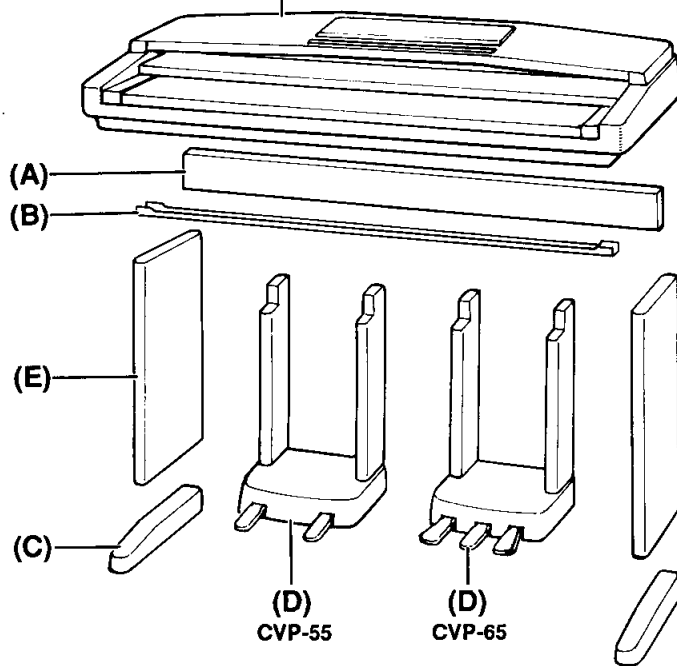

Assembly

Note: We do not recommend attempting to assemble the CVP-55/CVP-65 alone. The job can be easily accomplished, however, with only two people.

1 Open the box and remove all the parts.

On opening the box you should find the parts shown in the illustration. Check to make sure that all the required parts are provided.

2 Assemble the side panels (E) and feet (C).

Install the joint connectors in side panels (E) as shown in the illustration, then secure the feet (C) to the side panels (E) with the long gold-colored screws ①. Once secure, push in the plastic caps provided.

* When installing the joint connectors in the holes in the side panels (E), make sure that they are rotated to the position shown in the illustration.

3 Attach the side panels (E) to the center panel (A).

Attach the center panel (A) to the side panels (E) using the four medium screws ② as shown in the illustration.

4 Attach front bracket (B) between side panels (E).

Attach the long black metal bracket (B) to the corresponding brackets on the side panels using two short screws ⑤, as shown in the illustration. The flanged edges of bracket (B) should face upwards.

Montage

Hinweis: Wir raten davon ab, die Montage und Aufstellung des CVP-55/65 alleine auszuführen. Zwei Personen können das CVP-55/65 jedoch problemlos zusammenbauen und aufstellen.

1 Versandkarton öffnen und alle Teile auspacken.

Der Karton sollte all die in der linken Abbildung gezeigten Teile enthalten. Vergewissern Sie sich, daß alle benötigten Teile vorhanden sind.

2 Die Standbeine (E) und Füße (C) verschrauben.

Entsprechend der Abbildung die Verbindungsstücke an den Standbeinen (E) anbringen. Dann die Füße (C) mit Hilfe der goldfarbenen langen Schrauben ① an den Standbeinen (E) anschrauben. Nach dem Festziehen der Schrauben die mitgelieferten Plastikkappen auf die Schraublöcher aufsetzen.

* Beim Einsetzen der Verbindungsstücke in die Standbeine (E) sicherstellen, daß sie in die Position gedreht sind, wie in der Abbildung gezeigt.

3 Die Standbeine (E) mit dem Auflagebrett (A) verschrauben.

Die vier Verbindungsstücke in die Löcher in der Rückwand (A) einsetzen. Dann die beiden Standbeine (E) entsprechend der Abbildung mit Hilfe der mittleren Schrauben ② anschrauben.

4 Die Strebe (B) zwischen den Seitenplatten anbringen.

Gemäß der Abbildung die lange schwarze Metallstrebe (B) an den entsprechenden Halterungen der Seitenplatten mit zwei kurzen Schrauben ⑤ anbringen. Die Flanschenden der Strebe (B) sollten dabei nach oben weisen.

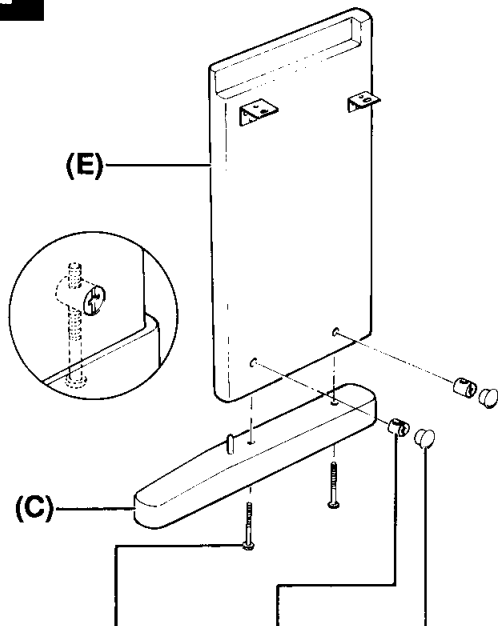
2

- Long gold-colored screws ①
- Lange goldfarbene Schrauben ①
- Vis longues dorées ①
- Tornillos largos dorados ①

- Plastic caps
- Plastikkappen
- Capuchons en plastique
- Tapas de plástico

- Joint connectors
- Gelenkverbinder
- Dispositifs d'assemblage
- Conectores de juntas

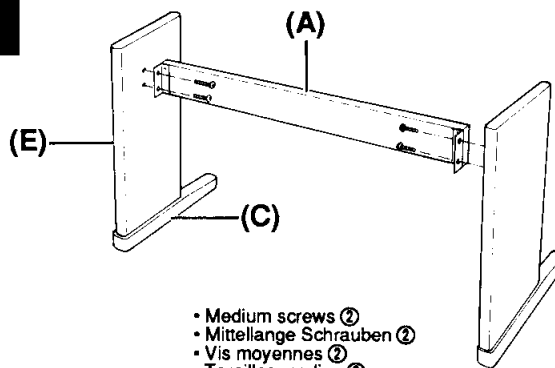
3

- Medium screws ②
- Mittellange Schrauben ②
- Vis moyennes ②
- Tornillos medios ②

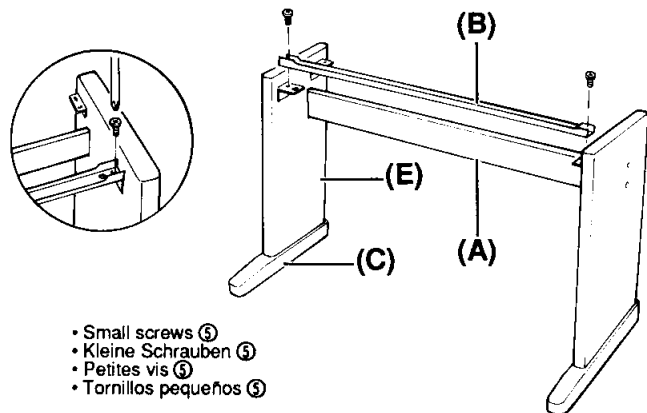
4

- Small screws ⑤
- Kleine Schrauben ⑤
- Petites vis ⑤
- Tornillos pequeños ⑤

Montage

Remarque: Nous ne vous conseillons pas d'essayer d'assembler le CVP-55/CVP-65 seul. Toutefois, ce travail peut être facilement exécuté par deux personnes.

1 Ouvrir le carton et retirer toutes les pièces

Les pièces indiquées sur l'illustration devraient toutes se trouver dans le carton. Vérifier qu'il n'en manque aucune.

2 Monter les panneaux latéraux (E) sur les pieds (C)

Poser les dispositifs d'assemblage sur les panneaux latéraux (E) de la manière illustrée, puis fixer les pieds (C) aux panneaux latéraux (E) à l'aide des vis longues dorées ①. Une fois les vis posées, placer les capuchons en plastique fournis.

* Lors de la pose des dispositifs d'assemblage dans les trous des panneaux latéraux (E), veiller à les diriger dans le sens indiqué sur l'illustration.

3 Fixer les panneaux latéraux (E) au panneau central (A)

Fixer le panneau central (A) sur les panneaux latéraux (E) à l'aide de quatre vis moyennes ① comme illustré.

4 Fixer les quatre supports avant (B) entre les panneaux latéraux (E)

Fixer de la manière illustrée les quatre supports métalliques longs de couleur noire (B) aux ferrures correspondantes des panneaux latéraux à l'aide de deux vis courtes ⑤. Le bord recourbé des supports (B) doit être dirigé vers le haut.

Montaje

Nota: No le recomendamos que intente montar la CVP-55/CVP-65 por usted mismo. El trabajo de montaje puede realizarse fácilmente entre dos personas.

1 Abra la caja y extraiga todas las partes.

Al abrir la caja, usted debe encontrar las partes mostradas en la ilustración. Compruebe para cerciorarse de que se proporcionan todas las partes necesarias.

2 Monte los paneles laterales (E) y las patas (C).

Instale los conectores de juntas en los paneles laterales (E) como se muestra en la ilustración, luego fije las patas (C) en los paneles laterales (E) con los tornillos largos dorados ①. Una vez fijadas, introduzca a presión las tapas de plástico que se proporcionan.

* Cuando instale los conectores de juntas en los orificios de los paneles laterales (E), asegúrese de que están girados en la posición mostrada en la ilustración.

3 Acople los paneles laterales (E) al panel central (A).

Una el panel central (A) en los paneles laterales (E) usando los cuatro tornillos medios ② como se muestra en la ilustración.

4 Acople la ménsula frontal (B) entre los paneles laterales (E).

Una la ménsula metálica larga y negra (B) en las ménsulas correspondientes de los paneles laterales usando dos tornillos cortos ⑤ como se muestra en la ilustración. Los rebordes de brida de la ménsula (B) deben estar encarados hacia arriba.

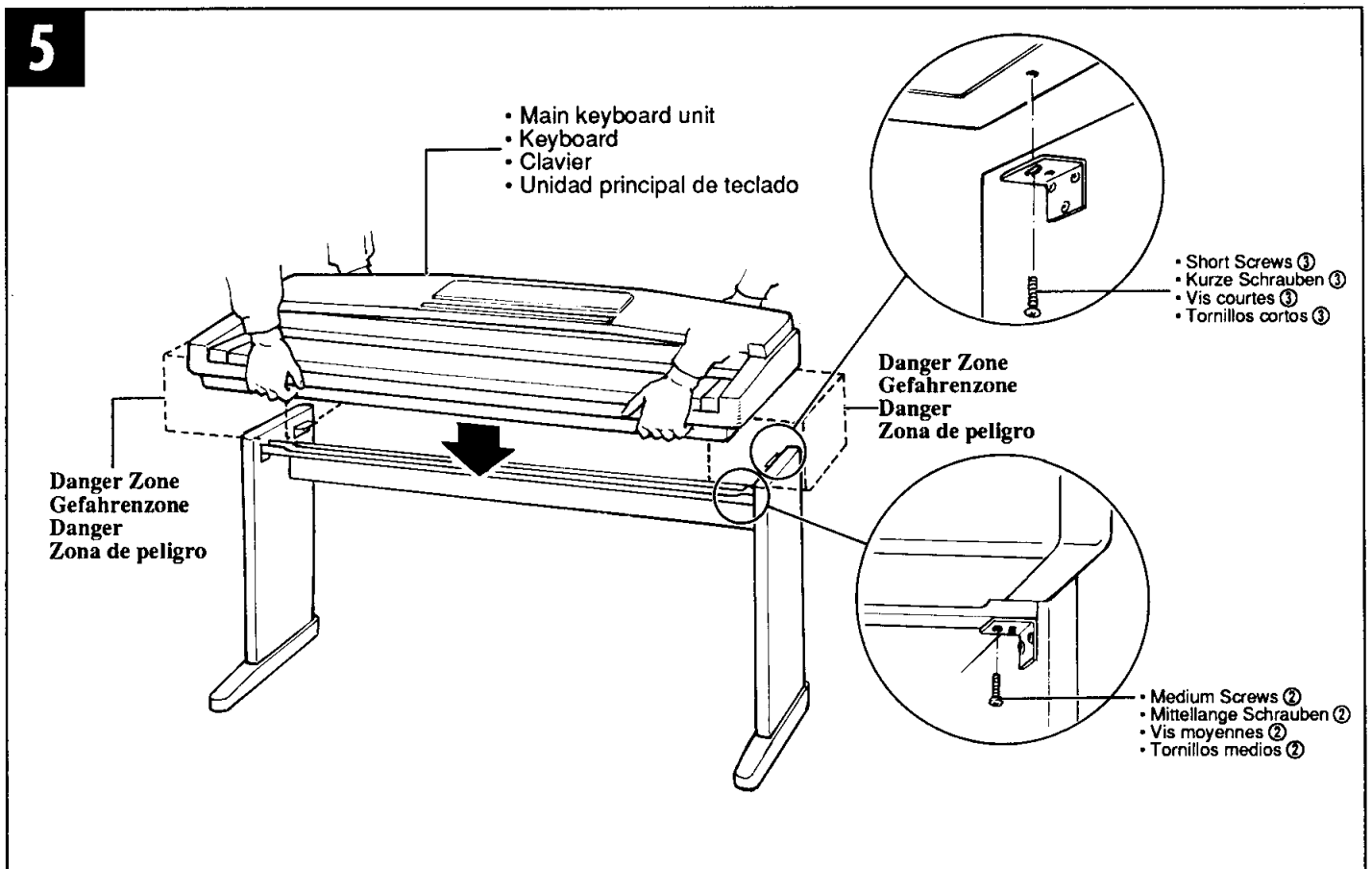
5

5 Install the main keyboard unit.

As shown in the illustration, gently lower the main keyboard unit onto the stand assembly so that the screw holes on the bottom of the keyboard match the holes in the brackets near the rear edge of the side panels (E). Secure the main keyboard unit to the stand assembly using two screws ③ screwed through the rear brackets and two screws ② through the front bracket.

* Keep your fingers away from the area marked "Danger Zone" in the illustration when lowering the main keyboard unit onto the stand assembly.

6 Attach the pedal assembly.

Before actually attaching the pedal assembly (D), be sure to plug the pedal cord connector which is protruding from the top of the pedal assembly into the corresponding connector in the bottom of the main keyboard unit. Once the pedal cord has been connected, tilt the main unit as shown in the illustration, align the pedal assembly with the screw holes on the main unit and center panel (A), making sure that the slack section of pedal cord fits into the recess in the top of the pedal assembly, and screw the four screws ④ into the center panel (A), and the four screws ③ into the main keyboard unit.

* Check to make sure that all screws have been securely tightened.

7 Be sure to set the pedal adjusters.

For stability, two adjusters are provided on the bottom of the pedal assembly (D). Rotate the adjusters until they come in firm contact with the floor surface. The adjusters ensure stable pedal operation and facilitates pedal effect control.

* If the adjusters are not in firm contact with the floor surface, distorted sound may result.

5 Das Keyboard montieren.

Gemäß der Abbildung das Keyboard vorsichtig auf den Ständer so absenken, daß die beiden schwarzen Plastikknöpfe auf der Unterseite des Keyboards in die größeren Löcher nahe der hinteren Kante der Seitenplatten (E) fassen. Das Keyboard mit zwei Schrauben ③ hinten und zwei Schrauben ② vorne befestigen.

* Beim Aufsetzen auf den Ständer das Keyboard nicht am mit "Gefahrenzone" bezeichneten Bereich fassen, um ein Einklemmen der Finger zu verhindern.

6 Pedalgestell anbringen.

Vor dem Anbringen des Pedalgestells (D) zunächst den Anschluß oben am Pedalgestell mit dem Anschluß unten am Keyboard verbinden. Nach dem Anschließen des Pedalkabels das Pedalgestell mit den Schraubenlöchern im Keyboard und am Auflagebrett (A) ausrichten. Dabei darauf achten, daß das Pedalkabel in der Einbuchtung oben am Pedalgestell sitzt. Dann das Pedalgestell mit vier Schrauben ④ am Auflagebrett (A) und mit vier Schrauben ③ am Keyboard anbringen.

* Sicherstellen, daß alle Schrauben gut festgezogen sind.

7 Stützschauben des Pedalgestells einstellen.

Zur Stabilisierung sind unten am Pedalgestell (D) zwei Stützschauben angebracht. Die Stützschauben drehen, bis sie am Boden aufsitzen. Die beiden Stützschauben gewährleisten Pedalstabilität und sorgen für akkurate Effektsteuerung.

* Falls die Stützschauben nicht am Boden aufsitzen, kann es zu Klangverzerrungen kommen.

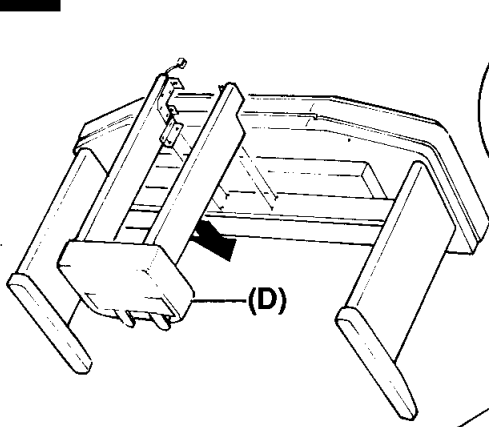
6

- Main keyboard unit
- Keyboard
- Clavier
- Unidad principal de teclado

- Small Screws ④
- Kleine Schrauben ④
- Petites vis ④
- Tornillos pequeños ④
- Short Screws ③
- Kurze Schrauben ③
- Vis courtes ③
- Tornillos cortos ③

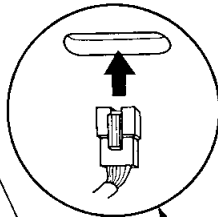

- The protrusion on the connector must face the rear of the main unit.
- Der Vorsprung am Stecker muß auf die Rückseite des Keyboards weisen.
- La partie en saillie du connecteur doit être dirigée vers l'arrière du clavier.
- El saliente del conector debe quedar encarado a la parte posterior de la unidad principal.

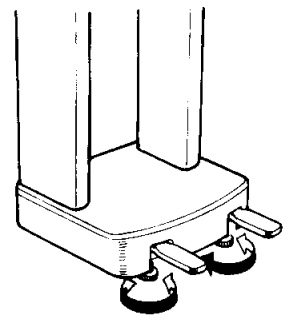
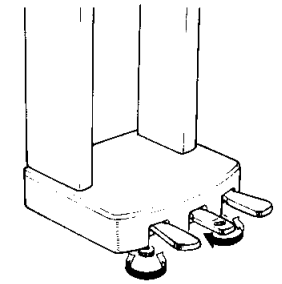
7**CVP-55****CVP-65**

5 Poser le clavier

Poser le clavier de la manière illustrée, en l'abaissant avec précaution sur l'ensemble et en veillant à ce que les orifices pour vis situés sous le clavier viennent se placer sur les orifices des supports situés près du bord arrière des panneaux latéraux (E). Fixer le clavier au support arrière à l'aide de deux vis ③ et aux supports avant à l'aide de deux vis ②.

* Pour abaisser le clavier sur l'ensemble, ne pas le tenir aux endroits marqués "Danger Zone" sur l'illustration.

6 Poser le pédalier

Avant de poser définitivement le pédalier (D), veiller à brancher le connecteur du cordon de pédale, sortant de la partie supérieure du pédalier, au connecteur correspondant situé à la partie inférieure du clavier. Une fois que le cordon de pédale est branché, incliner le clavier de la manière illustrée, aligner le pédalier sur les trous de vis du clavier et du panneau central (A), en veillant à placer le cordon de pédale dans la gorge située à la partie supérieure du pédalier et poser les quatre vis ④ sur le panneau central (A) et les quatre vis ③ sur le clavier.

* Vérifier que toutes les vis sont serrées à fond.

7 Ne pas oublier de régler la hauteur du pédalier

Deux dispositifs de réglage sont prévus à la partie inférieure du pédalier (D) pour assurer sa stabilité. Les tourner jusqu'à ce qu'ils soient en contact ferme avec la surface du sol. Ces dispositifs assurent la stabilité du pédalier lors de son utilisation et facilitent la commande au pied des effets.

* Si ces dispositifs ne sont pas en contact ferme avec le sol, il peut se produire une distorsion du son.

5 Instale la unidad del teclado principal

Como se muestra en la ilustración, baje con cuidado la unidad del teclado principal en el conjunto del soporte de forma que los orificios de tornillo de la parte inferior del teclado se correspondan con los orificios de las ménsulas cerca del borde posterior de los paneles laterales (E). Asegure la unidad del teclado principal en el conjunto del soporte enrosando dos tornillos ③ a través de las ménsulas traseras y dos tornillos ② a través de la ménsula frontal.

* Mantenga sus dedos alejados del área marcada con "Zona peligrosa" en la ilustración cuando baje la unidad del teclado principal en el conjunto del soporte.

6 Una el conjunto de pedales

Antes de acoplar el conjunto de pedales (D), asegúrese de enchufar el conector del cable de los pedales que sale desde la parte superior del conjunto de pedales en el conector correspondiente de la parte inferior de la unidad del teclado. Una vez se ha conectado el cable del pedal, incline la unidad principal como se muestra en la ilustración, alineando el conjunto de pedales con los orificios de tornillo de la unidad principal y panel central (A), asegurándose de que la sección floja del cable del pedal se acopla en el hueco de la parte superior del conjunto de pedales, y enrosque los cuatro tornillos ④ en el panel central (A), y los cuatro tornillos ③ en la unidad del teclado principal.

* Compruebe para cerciorarse de que todos los tornillos se han apretado bien.

7 Asegúrese de ajustar los ajustadores de pedal.

Para mejor estabilidad, se proporcionan dos ajustadores en la parte inferior del conjunto de pedales (D). Gire los ajustadores hasta que contacten firmemente con la superficie del piso. Los ajustadores aseguran una operación estable de los pedales y facilitan el control del efecto del pedal.

* Si los ajustadores no están en firme contacto con la superficie del suelo, el sonido se distorsionará.

Specifications

- * Specifications subject to change without notice.
- * Änderungen ohne Vorankündigung vorbehalten.
- * Sous toute réserve de modification des caractéristiques sans préavis.
- * Especificaciones sujetas a cambios sin previo aviso.

	CVP-55		CVP-65	
KEYBOARD	88 KEYS (A-1 — C7)			
TONE GENERATOR	AWM (Advanced Wave Memory)			
VOICE SELECTORS & CONTROLS	PIANO, CLAVINOVA TONE, E. PIANO, HARPSI, VIBES, GUITAR, STRINGS, ORGAN, CHOIR, UPRIGHT BASS, ELEC BASS, DRUMS, VOICE 13 - 53, SPLIT			
TOUCH SENSITIVITY	HARD, MEDIUM, SOFT			
PIANO ABC & CONTROLS	SINGLE FINGER, FINGERED, SOLO STYLEPLAY, RHYTHM VOLUME, CHORD 1 VOLUME, CHORD 2 VOLUME, BASS VOLUME			
STYLE DISK (CVP-65 only)	AMERICAN POP, 60'S, SOUL ROCK, 16 BEAT, ROCK BALLAD, COUNTRY ROCK, PIANO BALLAD, SOLO PIANO, RYTHM & BLUES, GOSPEL, BLUES SHUFFLE, CONTEMPORARY, DIXIE, RAGTIME, TANGO 1, TANGO 2, LAMBADA, SAMBA, BOSSA 1, BOSSA 2, REGGAE, LATIN POP, LATIN ROCK, CHA-CHA, WALTZ, VIENNESE WALTZ, CHANSON, POLKA, HAWAIIAN, CALYPSO, NEW AGE, COUNTRY SHUFFLE, FOLKLORE, JAPANESE POP 1, JAPANESE POP 2, JAPANESE POP 3, JAPANESE POP 4, ENKA 1, ENKA 2, ONDO			
RHYTHM SELECTORS & CONTROLS	POP 1/2, DANCE POP 1/2, 16 BEAT 1/2, ROCK'N', 16 BEAT 3, SLOW ROCK, SHUFFLE, COUNTRY 1/2, SWING 1/2, BIG BAND, BOOGIE, BOSSA, SAMBA, CHA-CHA, RHUMBA, MARCH, MARCH 6/8, WALTZ, J. WALTZ, START/STOP, INTRO/ENDING, NORMAL/FILL TO NORMAL, VARIATION/ FILL TO VARIATION, TEMPO ▲/▼, TEMPO Display, BEAT LED			
KEYBOARD PERCUSSION	BRUSH ROLL, HI-HAT CLOSED HEAVY, CRASH CYMBAL LIGHT, BASS DRUM LIGHT, SNARE DRUM + RIM HEAVY, RIDE CYMBAL CUP, SNARE DRUM + RIM LIGHT, BASS DRUM, RIM SHOT, SNARE DRUM HEAVY, BRUSH SHOT, SNARE DRUM LIGHT, HI-HAT PEDAL, SNARE DRUM ECHO, TOM 4, HI-HAT CLOSED, TOM 3, HI-HAT OPEN, TOM 2, TOM 1, RIDE CYMBAL, CRASH CYMBAL, CONGA LOW, CABASA, CONGA HIGH, METRONOME, BONGO, TIMBALE LOW, CLAVES, TIMBALE HIGH, CASTANETS, CUICA LOW, COWBELL, CUICA HIGH, HAND CLAPS, AGOGO LOW, AGOGO HIGH, BONGO LOW, TAMBOURINE, TRIANGLE CLOSED, TRIANGLE OPEN			
REVERB	ROOM, HALL 1, HALL 2, COSMIC			
PERFORMANCE MEMORY	RECORD 1/2/3-10, PLAY BACK 1/2/3-10, CHORD SEQUENCE			
DISK ORCHESTRA	SONG SELECT, LEFT ON, RIGHT ON, ORCH ON, PHRASE REPEAT, GUIDE (CVP-65 only), ►/■ START/STOP, ◀◀ REW, ▶▶ FF, PAUSE, SONG NUMBER Display, ▲/▼			
DISK DRIVE & CONTROLES	3.5" Micro Floppy Disk, built-in. 2DD 1M. COPY, FORMAT			
PEDAL CONTROLS	RIGHT	DAMPER		
	CENTER	—	SOSTENUTO	
	LEFT	SOFT (SOSTENUTO, START/STOP, SOLO STYLEPLAY)		SOFT (START/STOP, SOLO STYLEPLAY)
OTHER CONTROLS	MASTER VOLUME, MIDI/TRANPOSE, DEMO, POWER			
JACKS & CONNECTORS	HEADPHONES x 2, AUX. OUT R and L/L + R, OPTIONAL IN R/L, MIDI IN/OUT/THRU, EXP. PEDAL (CVP-65 only)			
INPUT & OUTPUT LEVEL/IMPEDANCE	AUX. OUT: 600 - 300 Ω/-4 dBm OPTIONAL IN: 22 kΩ/-10 dBm (for nominal output level)			
MAIN AMPLIFIERS	80 W (40 W x 2)		80 W (40 W x 2)	
SPEAKERS	13 cm (5-1/8") x 2, 5 cm (2") x 2		13 cm (5-1/8") x 2, 5 cm (2") x 2	
DIMENSIONS (W x D x H)	1416 mm x 582 mm x 817 mm (55-3/4" x 23" x 32-1/8")		1416 mm x 582 mm x 828 mm (55-3/4" x 23" x 32-5/8")	
WEIGHT	62.0 kg (136.7 lbs.)		64.0 kg (141.1 lbs.)	

















































Fingering Chart/Akkordliste/ Tablature/Gráfica de digitado

* All fingerings shown are simple root-position types.

* Die hier gezeigten Akkorde sind jeweils die Grundakkorde.

* Tous les doigtés indiqués sont du type à position fondamentale simple.

* Todos los digitados se muestran como tipos de posición de raíz sencilla.

Major Durakkord Majeur Mayor	Minor Mollakkord Mineur Menor	Seventh Septime Septième Séptima	Minor seventh Moll-Septakkord Septième mineure Menor de séptima
C 	Cm 	C7 	Cm7 
C# (D♭) 	C#m (D♭m) 	C#7 (D♭7) 	C#m7 (D♭m7) 
D 	Dm 	D7 	Dm7 
D# (E♭) 	D#m (E♭m) 	D#7 (E♭7) 	D#m7 (E♭m7) 
E 	Em 	E7 	Em7 
F 	Fm 	F7 	Fm7 
F# (G♭) 	F#m (G♭m) 	F#7 (G♭7) 	F#m7 (G♭m7) 
G 	Gm 	G7 	Gm7 
G# (A♭) 	G#m (A♭m) 	G#7 (A♭7) 	G#m7 (A♭m7) 
A 	Am 	A7 	Am7 
A# (B♭) 	A#m (B♭m) 	A#7 (B♭7) 	A#m7 (B♭m7) 
B 	Bm 	B7 	Bm7 

Fingering Chart/Akkordliste/Tablature/Gráfica de digitado

Major seventh
Durakkord mit großer
Septime
Septième majeure
Mayor de séptima

Minor major seventh
Mollakkord mit großer
Septime
Septième majeure mineure
Menor de séptima mayor

Augmented
Übermäßig
Augmenté
Aumentado

Diminished
Vermindert
Diminué
Disminuido

CM ₇		CmM ₇		Caug		Cdim	
C#M ₇ (D♭M ₇)		C#mM ₇ (D♭mM ₇)		C#aug (D♭aug)		C#dim (D♭dim)	
DM ₇		DmM ₇		Daug		Ddim	
D#M ₇ (E♭M ₇)		D#mM ₇ (E♭mM ₇)		D#aug (E♭aug)		D#dim (E♭dim)	
EM ₇		EmM ₇		Eaug		Edim	
FM ₇		FmM ₇		Faug		Fdim	
F#M ₇ (G♭M ₇)		F#mM ₇ (G♭mM ₇)		F#aug (G♭aug)		F#dim (G♭dim)	
GM ₇		GmM ₇		Gaug		Gdim	
G#M ₇ (A♭M ₇)		G#mM ₇ (A♭mM ₇)		G#aug (A♭aug)		G#dim (A♭dim)	
AM ₇		AmM ₇		Aaug		Adim	
A#M ₇ (B♭M ₇)		A#mM ₇ (B♭mM ₇)		A#aug (B♭aug)		A#dim (B♭dim)	
BM ₇		BmM ₇		Baug		Bdim	

**Sixth
Sexte
Sixième
Sexta**

**Suspended fourth
Vorgehaltene
Quarte
Quarte suspendue
Cuarta suspendida**

**Minor seventh flat five
Moll-Septakkord mit
verminderter Quinte
Quinte bémol septième
mineure
Menor de séptima
quinta bemol**

**Major seventh flat five
Dur-Septakkord mit
verminderter Quinte
Quinte bémol septième
majeure
Mayor de séptima
quinta bemol**

C ₆		Csus ₄		Cm ₇₋₅		CM ₇₋₅	
C# ₆ (D ^b ₆)		C#sus ₄ (D ^b sus ₄)		C#m ₇₋₅ (D ^b m ₇₋₅)		C#M ₇₋₅ (D ^b M ₇₋₅)	
D ₆		Dsus ₄		Dm ₇₋₅		DM ₇₋₅	
D# ₆ (E ^b ₆)		D#sus ₄ (E ^b sus ₄)		D#m ₇₋₅ (E ^b m ₇₋₅)		D#M ₇₋₅ (E ^b M ₇₋₅)	
E ₆		Esus ₄		Em ₇₋₅		EM ₇₋₅	
F ₆		Fsus ₄		Fm ₇₋₅		FM ₇₋₅	
F# ₆ (G ^b ₆)		F#sus ₄ (G ^b sus ₄)		F#m ₇₋₅ (G ^b m ₇₋₅)		F#M ₇₋₅ (G ^b M ₇₋₅)	
G ₆		Gsus ₄		Gm ₇₋₅		GM ₇₋₅	
G# ₆ (A ^b ₆)		G#sus ₄ (A ^b sus ₄)		G#m ₇₋₅ (A ^b m ₇₋₅)		G#M ₇₋₅ (A ^b M ₇₋₅)	
A ₆		Asus ₄		Am ₇₋₅		AM ₇₋₅	
A# ₆ (B ^b ₆)		A#sus ₄ (B ^b sus ₄)		A#m ₇₋₅ (B ^b m ₇₋₅)		A#M ₇₋₅ (B ^b M ₇₋₅)	
B ₆		Bsus ₄		Bm ₇₋₅		BM ₇₋₅	

Fingering Chart/Akkordliste/Tablature/Gráfica de digitado

Half diminished (minor major seventh flat five)

Halbvermindert

Demi diminué (Quinte bémol septième majeure mineure)

Medio disminuido (menor de séptima mayor quinta bemol)

Minor sixth

Mollakkord mit hinzugefügter Sexte

Sixième mineure

Menor de sexta

Seventh suspended fourth

Septakkord mit vorgehaltener Quarte

Quarte suspendue septième

Séptima cuarta suspendida

Major flat five

Durakkord mit verminderter Quinte

Quinte bémol majeure

Mayor de quinta bemol



Minor flat five
Mollakkord mit
verminderter Quinte
Quinte bémol mineure
Menor de quinta bemol



Seventh flat five
Septakkord mit
verminderter Quinte
Quinte bémol septième
Séptima quinta bemol



Seventh sharp five
Dur-Septakkord mit
erhöhter Quinte
Quinte dièse septième
Séptima quinta
sostenida



Major seventh sharp five
Durakkord mit Septime
und erhöhter Quinte
Quinte dièse septième
majeure
Mayor de séptima quinta
sostenida



Function	Transmitted	Recognized	Remarks
Basic Default	: 1	: 1	:
Channel Changed	: 1-16	: 1-16	:
Mode Default Messages	: 3 : X : *****	: 1 : OMNIon,OMNIoff : X	:
Note Number : True voice	: 21-108 : *****	: 21-108 : 21-108	:
Velocity Note on	: 0 9nH,v=1-127	: 0 v=1-127	:
Velocity Note off	: X 9nH,v=0	: X	:
After Touch Key's Ch's	: X : X	: X : X	:
Pitch Bender	: 0	: 0	:
Control Change	01 : 0 07 : 0 10 : X 11 : 0 64 : 0 66 : 0 67 : 0 91 : 0 121 : X	: 0 : 0 : 0 : 0 : 0 : 0 : 0 : 0 : 0	: Modulation : Volume : Pan pot : Expression : Damper : Sostenuto : Soft Pedal : Reverb Depth : Reset All : Controllers *1
Program Change : True #	: 0 0-52 : *****	: 0 0-127 : 0-127	:
System Exclusive	: 0	: 0	:
System Common	: Song Pos : X : Song Sel : X : Tune : X	: X : X : X	:
System Real Time	: Clock : 0 : Commands : 0	: 0 : 0	:
Aux Messages	: Local ON/OFF : X : All Notes OFF : X : Active Sense : 0 : Reset : X	: 0 : 0 (123-125) *1 : 0 : X	:
Notes : *1 = receive (121,123) if omni off or multi-timbre on			
Mode 1	: OMNI ON, POLY	Mode 2 : OMNI ON, MONO	0 : Yes
Mode 3	: OMNI OFF, POLY	Mode 4 : OMNI OFF, MONO	X : No

Function	Transmitted	Recognized	Remarks
Basic Default	: 1	: 1	
Channel Changed	: 1-16	: 1-16	
Mode Default	: 3	: 1	
Messages	: X	: OMNIon,OMNIoff	
	: *****	: X	
Note Number : True voice	: 21-108	: 21-108	
	: *****	: 21-108	
Velocity Note on	: 0 9nH,v=1-127	: 0 v=1-127	
Note off	: X 9nH,v=0	: X	
After Key's	: X	: X	
Touch Ch's	: X	: X	
Pitch Bender	: 0	: 0	
Control	01 : 0	: 0	:Modulation
	07 : 0	: 0	:Volume
	10 : X	: 0	:Pan pot
	11 : 0	: 0	:Expression
	64 : 0	: 0	:Damper
	66 : 0	: 0	:Sostenuto
Change	67 : 0	: 0	:Soft Pedal
	91 : 0	: 0	:Reverb Depth
	121 : X	: 0	:Reset All
			: Controllers *1
Program Change : True #	: 0 0-52	: 0 0-127	
	: *****	: 0-127	
System Exclusive	: 0	: 0	
System : Song Pos	: X	: X	
: Song Sel	: X	: X	
Common : Tune	: X	: X	
System :Clock	: 0	: 0	
Real Time:Commands	: 0	: 0	
Aux :Local ON/OFF	: X	: 0	
:All Notes OFF	: X	: 0 (123-125) *1	
Mes- :Active Sense	: 0	: 0	
sages:Reset	: X	: X	
Notes : *1 = receive (121,123) if omni off or multi-timbre on			

Mode 1 : OMNI ON, POLY Mode 2 : OMNI ON, MONO 0 : Yes
 Mode 3 : OMNI OFF, POLY Mode 4 : OMNI OFF, MONO X : No

FCC INFORMATION (U.S.A.)

1. IMPORTANT NOTICE: DO NOT MODIFY THIS UNIT!

This product, when installed as indicated in the instructions contained in this manual, meets FCC requirements. Modifications not expressly approved by Yamaha may void your authority, granted by the FCC, to use the product.

2. IMPORTANT: When connecting this product to accessories and/or another product use only high quality shielded cables. Cable/s supplied with this product MUST be used. Follow all installation instructions. Failure to follow instructions could void your FCC authorization to use this product in the USA.

3. NOTE: This product has been tested and found to comply with the requirements listed in FCC Regulations, Part 15 for Class "B" digital devices. Compliance with these requirements provides a reasonable level of assurance that your use of this product in a residential environment will not result in harmful interference with other electronic devices. This equipment generates/uses radio frequencies and, if not installed and used according to the instructions found in the users manual, may cause interference harmful to the operation of other electronic devices. Compliance with FCC regulations does not guarantee that interference will not occur in all installations. If this product is found to be the source of interference, which can be determined by turning the unit "OFF" and "ON", please try to eliminate the problem by using one of the following measures:

Relocate either this product or the device that is being affected by the interference.

Utilize power outlets that are on different branch (circuit breaker or fuse) circuits or install AC line filter/s.

In the case of radio or TV interference, relocate/reorient the antenna. If the antenna lead-in is 300 ohm ribbon lead, change the lead-in to co-axial type cable.

If these corrective measures do not produce satisfactory results, please contact the local retailer authorized to distribute this type of product. If you can not locate the appropriate retailer, please contact Yamaha Corporation of America, Electronic Service Division, 6600 Orangethorpe Ave, Buena Park, CA90620

The above statements apply ONLY to those products distributed by Yamaha Corporation of America or its subsidiaries.

* This applies only to products distributed by YAMAHA CORPORATION OF AMERICA.

NAME PLATE LOCATION: The nameplate is located on the bottom panel, toward the rear panel. The Model, Serial Number, Power requirements, etc., are indicated on this plate.

You should note the model, serial number and the date of purchase in the spaces provided below and retain this manual as a permanent record of your purchase.

Model _____

Serial No. _____

Purchase Date _____

LAGE DES TYPENSCHILDS: Das Typenschild befindet sich am Geräteboden neben der Rückwand. Modellbezeichnung, Seriennummer, Betriebsstrom etc, sind auf dem Typenschild angegeben. Tragen Sie Modellbezeichnung, Seriennummer und Kaufdatum in die unten vorhandenen Felder ein und bewahren Sie dieses Handbuch als permanenten Kaufbeleg auf.

Modell _____

Seriennummer _____

Kaufdatum _____

EMPLACEMENT DE LA PLAQUE SIGNALÉTIQUE: La plaque signalétique se trouve sur le panneau inférieur, côté panneau arrière. Le modèle, le numéro de série, l'alimentation requise et autres paramètres sont indiqués sur cette plaque. Inscrive le modèle, le numéro de série et la date de l'achat dans l'espace prévu cidessous et conserver le mode d'emploi à titre d'enregistrement permanent de l'achat.

Modèle _____

N° de série _____

Date de l'achat _____

UBICACION DE LA PLACA DE CARACTERISTICAS: La placa de características está situada en el panel inferior, hacia el panel posterior. En esta placa se indican el modelo, el número de serie, la tensión de alimentación, etc. Anote el modelo, el número de serie, y la fecha de adquisición en los espacios ofrecidos a continuación, y guwarde este manual como registro permanente de su adquisición.

Modelo _____

N.º de serie _____

Fecha de adquisición _____

Wichtiger Hinweis für die Benutzung in der Bundesrepublik Deutschland.

Bescheinigung des Importeurs

Hiermit wird bescheinigt, daß der/die/das
Electronic Piano Typ: CVP-55

(Gerät, Typ, Bezeichnung)

in Übereinstimmung mit den Bestimmungen der
VERFÜGUNG 1046/84

(Amtsblattverfügung)

funk-entstört ist.

Der Deutschen Bundespost wurde das Inverkehrbringen dieses Gerätes angezeigt und die Berechtigung zur Überprüfung der Serie auf Einhaltung der Bestimmungen eingeräumt.

Yamaha Europa GmbH

Name des Importeurs

- Dies bezieht sich nur auf die von der Yamaha Europa GmbH vertriebenen Produkte.

Wichtiger Hinweis für die Benutzung in der Bundesrepublik Deutschland.

Bescheinigung des Importeurs

Hiermit wird bescheinigt, daß der/die/das
Electronic Piano Typ: CVP-65

(Gerät, Typ, Bezeichnung)

in Übereinstimmung mit den Bestimmungen der
VERFÜGUNG 1046/84

(Amtsblattverfügung)

funk-entstört ist.

Der Deutschen Bundespost wurde das Inverkehrbringen dieses Gerätes angezeigt und die Berechtigung zur Überprüfung der Serie auf Einhaltung der Bestimmungen eingeräumt.

Yamaha Europa GmbH

Name des Importeurs

- Dies bezieht sich nur auf die von der Yamaha Europa GmbH vertriebenen Produkte.

IMPORTANT NOTICE FOR THE UNITED KINGDOM

Connecting the Plug and Cord

IMPORTANT. the wires in this mains lead are coloured in accordance with the following code:

BLUE : NEUTRAL
BROWN : LIVE

As the colours of the wires in the mains lead of this apparatus may not correspond with the coloured markings identifying the terminals in your plug proceed as follows:

The wire which is coloured BLUE must be connected to the terminal which is marked with the letter N or coloured BLACK.

The wire which is coloured BROWN must be connected to the terminal which is marked with the letter L or coloured RED.

Making sure that neither core is connected to the earth terminal of the three pin plug.

- This applies only to products distributed by Yamaha-Kemble Music (U.K.) Ltd.

CANADA

THIS DIGITAL APPARATUS DOES NOT EXCEED THE "CLASS B" LIMITS FOR RADIO NOISE EMISSIONS FROM DIGITAL APPARATUS SET OUT IN THE RADIO INTERFERENCE REGULATION OF THE CANADIAN DEPARTMENT OF COMMUNICATIONS.

LE PRESENT APPAREIL NUMERIQUE N'EMET PAS DE BRUITS RADIOELECTRIQUES DEPASSANT LES LIMITES APPLICABLES AUX APPAREILS NUMERIQUES DE LA "CLASSE B" PRESCRITES DANS LE REGLEMENT SUR LE BROUILLAGE RADIOELECTRIQUE EDICTE PAR LE MINISTERE DES COMMUNICATIONS DU CANADA.

- This applies only to products distributed by Yamaha Canada Music Ltd.
- Ceci ne s'applique qu'aux produits distribués par Yamaha Canada Musique Ltée.

Dette apparat overholder det gældende EF-direktiv vedrørende radiostøj.

Cet appareil est conforme aux prescriptions de la directive communautaire 87/308/CEE.

Diese Geräte entsprechen der EG-Richtlinie 82/499/EWG und/oder 87/308/EWG.

This product complies with the radio frequency interference requirements of the Council Directive 82/499/EEC and/or 87/308/EEC.

Questo apparecchio è conforme al D.M. 13 aprile 1989 (Direttiva CEE/87/308) sulla soppressione dei radiodisturbi.

Este producto está de acuerdo con los requisitos sobre interferencias de radio frecuencia fijados por el Consejo Directivo 87/308/CEE.

YAMAHA CORPORATION

YAMAHA