

YAMAHA KX-250

Natural Sound Stereo Cassette Deck

CENTER

OWNER'S MANUAL



IMPORTANT

Please record the serial number of your unit in the space below.

Model: **KX-250**

Serial No:

The serial number is located on the rear of the unit.

Retain this Owner's Manual in a safe place for future reference.

Thank you for purchasing the YAMAHA KX-250 stereo cassette deck.

SAFETY INSTRUCTIONS

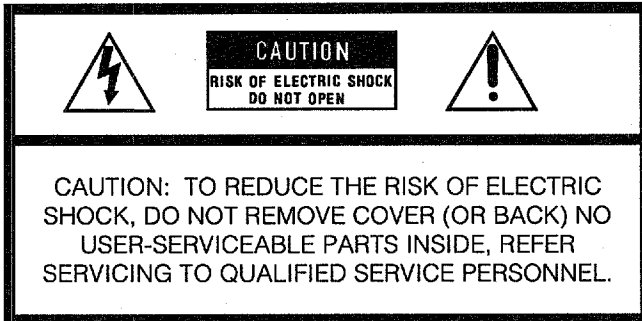

• Explanation of Graphical Symbols



The lightning flash with arrowhead symbol, within an equilateral triangle, is intended to alert you to the presence of uninsulated "dangerous voltage" within the product's enclosure that may be of sufficient magnitude to constitute a risk of electric shock to persons.



The exclamation point within an equilateral triangle is intended to alert you to the presence of important operating and maintenance (servicing) instructions in the literature accompanying the appliance.

WARNING

To reduce the risk of fire or electric shock, do not expose this appliance to rain or moisture.

1 Read Instructions — All the safety and operating instructions should be read before the appliance is operated.

2 Retain Instructions — The safety and operating instructions should be retained for future reference.

3 Heed Warnings — All warnings on the appliance and in the operating instructions should be adhered to.

4 Follow Instructions — All operating and other instructions should be followed.

5 Water and Moisture — The appliance should not be used near water — for example, near a bathtub, washbowl, kitchen sink, laundry tub, in a wet basement, or near swimming pool, etc.

6 Carts and Stands — The appliance should be used only with a cart or stand that is recommended by the manufacturer.

6A An appliance and cart combination should be moved with care. Quick stops, excessive force, and uneven surfaces may cause the appliance and cart combination to overturn.



7 Wall or Ceiling Mounting — The appliance should be mounted to a wall or ceiling only as recommended by the manufacturer.

8 Ventilation — The appliance should be situated so that its location or position does not interfere with its proper ventilation. For example, the appliance should not be situated on a bed, sofa, rug or similar surfaced that may block the ventilation openings: or placed in a built-in installation, such as a bookcase or cabinet that may impede the flow of air through the ventilation openings.

9 Heat — The appliance should be situated away from heat sources such as radiators, stoves, or other appliances that produce heat.

10 Power Sources — The appliance should be connected to a power supply only of the type described in the operating instructions or as marked on the appliance.

11 Power-Cord Protection — Power-supply cords should be routed so that they are not likely to be walked on or pinched by items placed upon or against them, paying receptacles, and the point where they exit from the appliance.

**CAUTION: READ THIS BEFORE
OPERATING YOUR UNIT.**

12 Cleaning — The appliance should be cleaned only as recommended by the manufacturer.

13 Non use Periods — The power cord of the appliance should be unplugged from the outlet when left unused for a long period of time.

14 Object and Liquid Entry — Care should be taken so that objects do not fall into and liquids not spilled into the inside of the appliance.

15 Damage Requiring Service — The appliance should be serviced by qualified service personnel when:

- A. The power-supply cord or the plug has been damaged; or
- B. Objects have fallen, or liquid has been spilled into the appliance; or
- C. The appliance has been exposed to rain; or
- D. The appliance does not appear to operate normally or exhibits a marked change in performance; or
- E. The appliance has been dropped, or the cabinet damaged.

16 Servicing — The user should not attempt to service the appliance beyond those means described in the operating instructions. All other servicing should be referred to qualified service personnel.

1. This unit is a sophisticated stereo cassette deck. To ensure proper operation for the best possible performance, please read this manual carefully.
2. Choose the installation location of your unit carefully. Avoid placing it in direct sunlight or close to source of heat. Also avoid locations subject to vibration and excessive dust, heat, cold or moisture. Keep it away from sources of hum such as transformers or motors.
3. Do not open the cabinet as this may result in damage to the deck or electrical shock. If a foreign object should get into the deck, contact your local dealer.
4. When removing the power plug from the wall outlet, always pull directly on the plug; never pull the cord itself.
5. Do not apply excessive force when operating switches and knobs.
6. When moving the deck, be sure to first pull out the power plug and remove all cords connecting the deck to other equipment.
7. Do not attempt to clean this unit with chemical solvents as this may damage the finish. Use a clean, dry cloth.
8. Never allow metallic items (e.g. screwdrivers, tools, etc.) to come near the record/playback head assembly. Doing so may not only scratch or damage the head's mirror-smooth finish, it may also change the magnetic characteristics of the heads, causing a deterioration in reproduction quality.
9. Although the record/playback head used in this unit is a high quality head with outstanding reproduction characteristics, it can become dirty through the use of old tapes or from dust accumulation over time. This can have a serious effect on reproduction quality. Clean the heads regularly with one of the commonly available head cleaners or with cleaning solutions as explained later in this manual.
10. Be sure to read the "Troubleshooting" section of this manual for advice on common operating errors before concluding that your unit is faulty.
11. Keep this manual in a safe place for future reference.
12. Voltage Selector (general model only)
The voltage selector on the rear panel of this unit must be set for your local mains voltage BEFORE plugging in the AC mains supply.

TABLE OF CONTENTS

Futures	4	Rec Return operation - To return to the point at which the recording previously started	9
Connections	4	Timer recording/playback	10
Playback	5	Timer recording	10
Selection search - To playback a desired selection by searching for the beginning of the selection	6	Timer playback	10
Intro scan - To play back the beginning of each selection automatically	7	Cassette tapes	11
Phrase repeat (To repeatedly play a section) or Full repeat (an entire side)	7	Maintenance	12
Recording	8	Optional remote control transmitter	12
Rec mute operation - Inserting a blank space during recording	9	Troubleshooting	13
		Specifications	14

FEATURES

- Dolby HX Pro Dynamic Bias Servo
- Dolby B/C Noise Reduction
- Fine Adjustment of Recording Bias with Bias Adjust Control
- Play Trim Control for Improved Playback Compatibility with Other Decks
- Full/Phrase Repeat Play, Selection Search and Bi-Directional Intro Scan
- Recording Mute function

CONNECTIONS

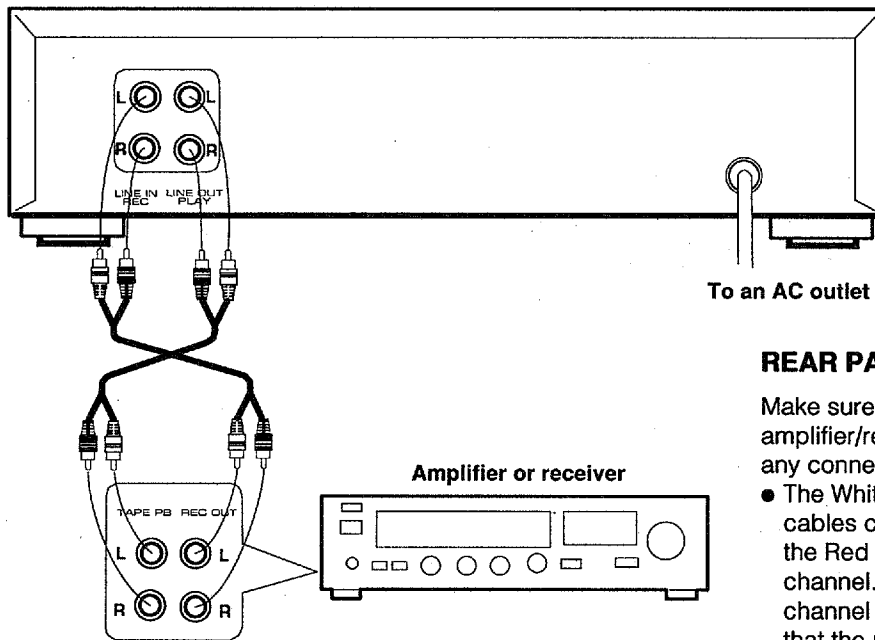

REAR PANEL CONNECTIONS

Make sure that power to both the deck and your amplifier/receiver are turned off before making any connection.

- The White plug on the paired connecting cables corresponds to the Left channel and the Red plug corresponds to the Right channel. Make sure that the left and right channel connections are properly made, and that the plugs are inserted firmly.
- The LINE OUT/PLAY jacks on the deck should be connected to the Tape PB (Playback/ Input) jacks on your amplifier/receiver, and the LINE IN/REC jacks on the deck should be connected to the Rec Out (Rec/Output) jacks on your amplifier/receiver.
- Connect the power cord to an AC wall outlet or to an AC outlet on the rear panel of your amplifier/receiver (if provided).

PLAYBACK

Preparation for playback

- Be sure to set the AUTO MODE selector to the OFF position, then turn on the POWER switch.
- Set your amplifier or receiver to cassette deck function mode.

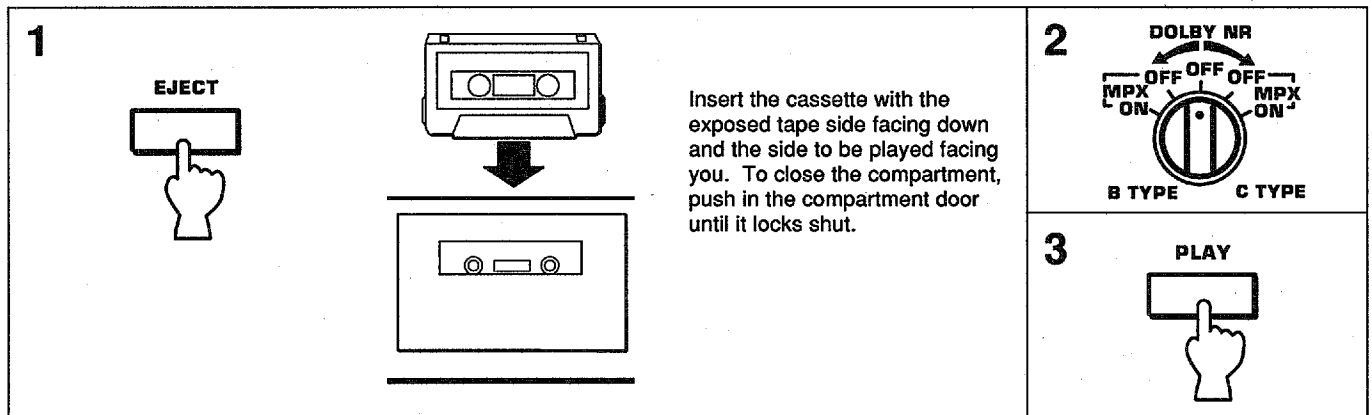
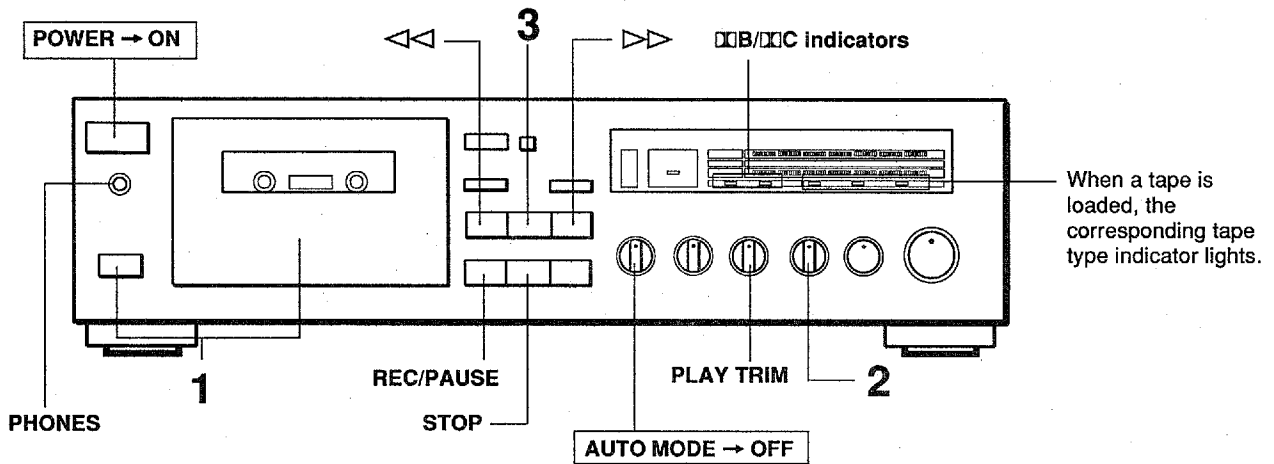

To stop playback:

Press the STOP button.

To fast forward the tape:

Press the ▷▷ button.

To fast rewind the tape:

Press the ◀◀ button.

To adjust the volume level:

Use the volume control of the amplifier or receiver.

To use headphones for private listening:

Insert the headphones plug into the PHONES jack.

DOLBY NR switch setting (in step 2)

Be sure to set the DOLBY NR switch according to the system used for recording.

OFF: For a tape recorded with DOLBY NR OFF.

B TYPE MPX OFF: For a tape recorded with DOLBY B NR (even for a tape recorded with DOLBY B NR MPX ON). The ◻◻B indicator lights.

C TYPE MPX OFF: For a tape recorded with DOLBY C NR (even for a tape recorded with DOLBY C NR MPX ON). The ◻◻C indicator lights.

* Dolby noise reduction manufactured under license from Dolby Laboratories Licensing Corporation. "DOLBY" and the double-D symbol ◻◻ are trademarks of Dolby Laboratories Licensing Corporation.

PLAYBACK

PLAY TRIM control adjustment

When distortion or the absence of high frequencies is noticeable when playing a tape recorded on another cassette deck, compensate the high frequency response with the PLAY TRIM control.

When distortion is noticeable, attenuate the high frequencies.

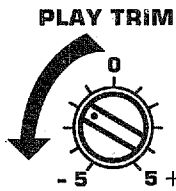

When high frequencies are absent, boost the high frequencies.

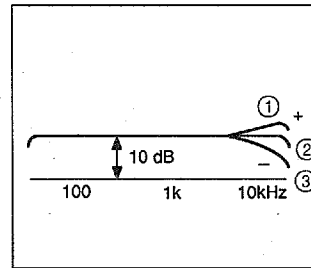
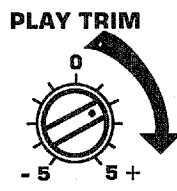

- ① High frequency sound is distorted.
- ② Flat
- ③ High-frequency sound is absent.

Selection search - To play back a desired selection by searching for the beginning of the selection

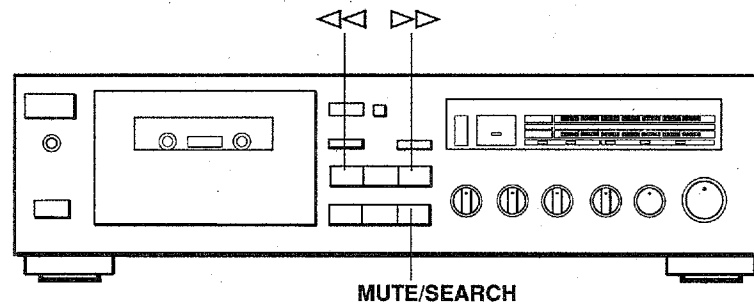

To search for the next selection

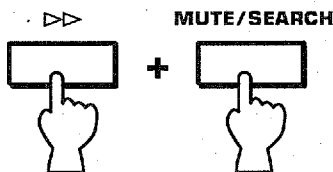

The << or >> button and the MUTE/SEARCH button should be pressed simultaneously.

To search for the beginning of the current selection

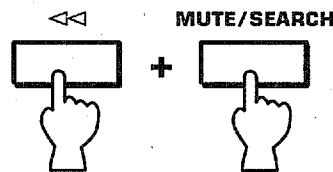

The << or >> button and the MUTE/SEARCH button should be pressed simultaneously.

To search for the selection located before the current selection

When the beginning of the current selection is played:

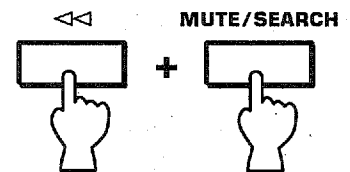

Intro scan - To play back the beginning of each selection automatically

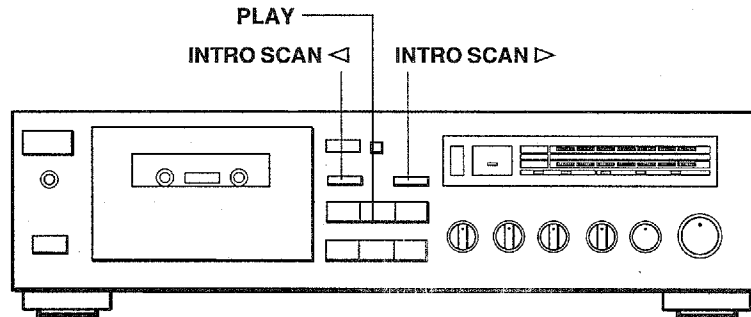

To play back each selection in the reverse direction:



To play back each selection in the forward direction:



To resume normal playback when the desired selection is found:

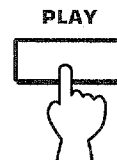

Notes on Selection search and Intro scan

- The blank section between selections must be at least 4 seconds.
- With tapes recorded with low level or having excessive noise, these operations may not be carried out.

Phrase repeat (To repeatedly play a section) or Full repeat (an entire side)

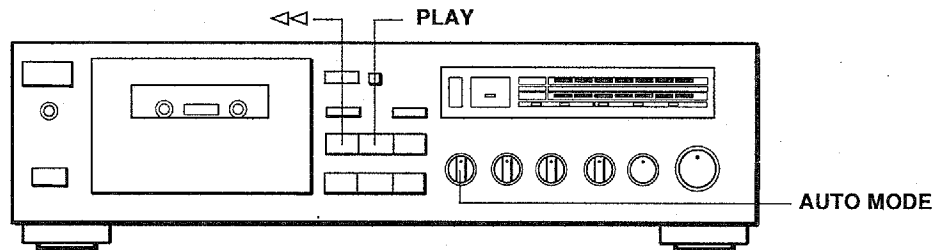

Phrase repeat

1



2 During playback, press the PLAY button at the beginning of the section to be repeated.



3 Press the <<< button at the end of the section.

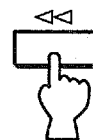

The tape will be rewound to the point where the PLAY button was pressed and the selected section will be repeatedly played up to 8 times.

Full repeat



The AUTO MODE selector can be set during playback or before starting playback. The side being played will be repeatedly played up to 8 times.

RECORDING

Preparation for recording

- Be sure to set the AUTO MODE selector to the OFF position, then turn on the POWER switch.
- Set your amplifier or receiver to cassette deck function mode.

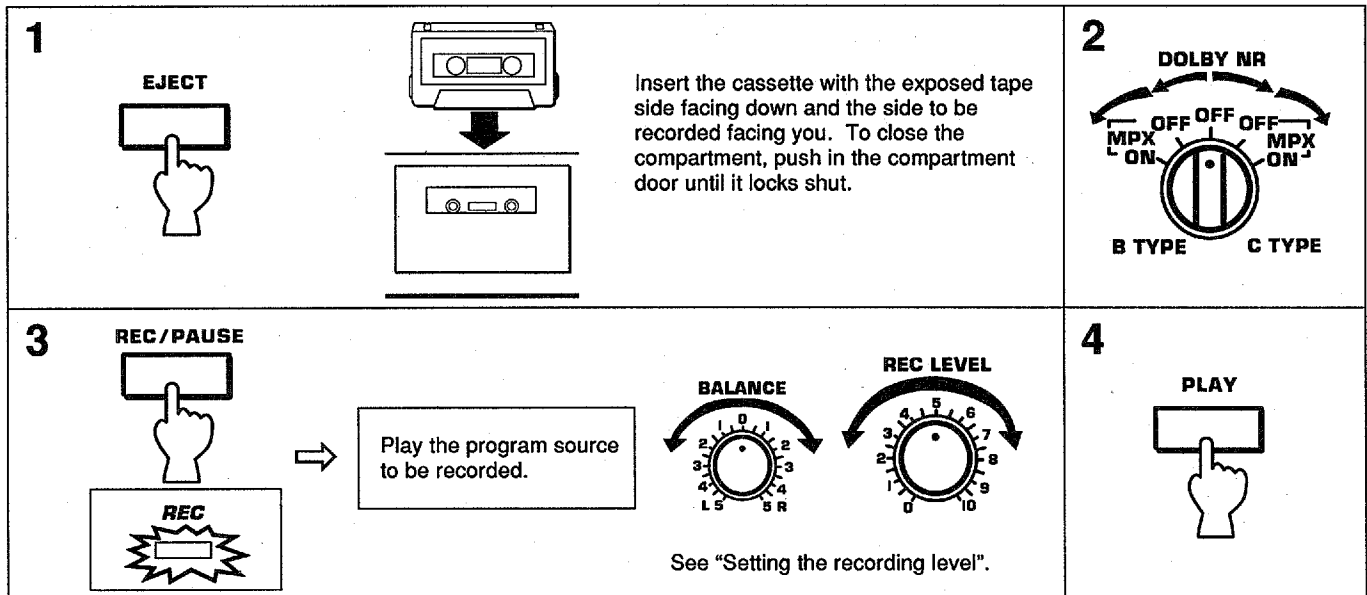
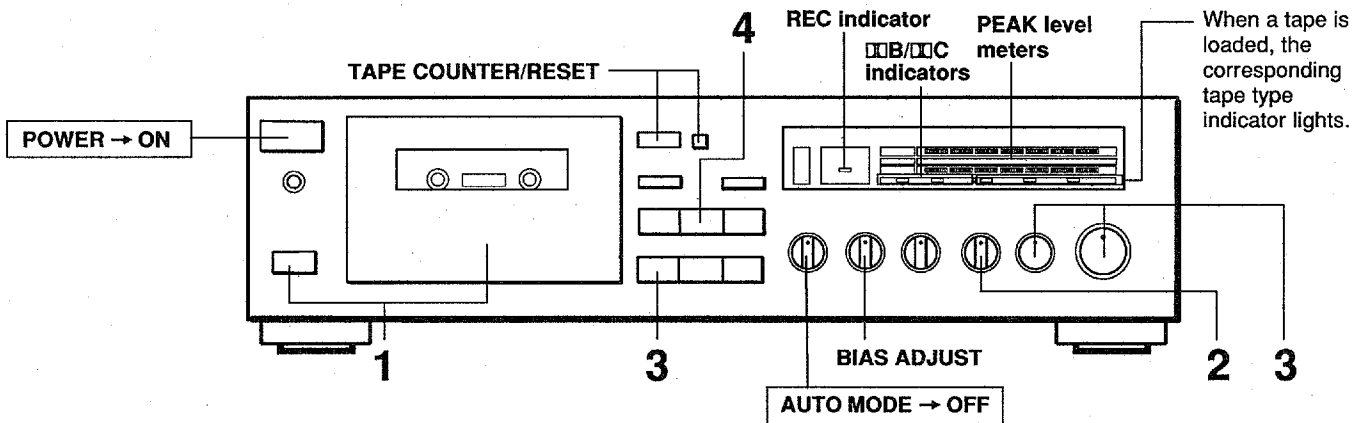

DOLBY NR switch setting (in step 2)

OFF: No noise reduction.

B TYPE MPX OFF: Recording sources other than FM broadcasts with Dolby B NR. The $\square\square B$ indicator lights.

B TYPE MPX ON: Recording an FM broadcast with Dolby B NR. The $\square\square B$ indicator lights.

C TYPE MPX OFF: Recording sources other than FM broadcasts with Dolby C NR. The $\square\square C$ indicator lights.

C TYPE MPX ON: Recording an FM broadcast with Dolby C NR. The $\square\square C$ indicator lights.

- Dolby noise reduction is an extremely effective method of reducing undesirable background hiss on tapes. This unit incorporates both Dolby B NR and the newer Dolby C NR system. Dolby C NR is approximately twice as effective as the earlier Dolby B NR.

- FM stations transmit a 19 kHz pilot signal in addition to the broadcast program. Sometimes this pilot signal may leak into the audio output depending on the tuner and broadcast conditions. This signal can cause improper operation of the Dolby NR systems. Activating the MPX filter (B TYPE/C TYPE MPX ON settings) will effectively remove the signal.

To stop recording:
Press the STOP button.

To stop recording temporarily:
Press the REC/PAUSE button. To resume recording, press the PLAY button.

TAPE COUNTER and RESET button

Before starting recording, press the RESET button to set the counter reading to "000". Use this counter as aid in locating a point on a tape.

Bias adjustment

The BIAS ADJUST control is for fine adjustment of the recording bias. Normally, it is not necessary to adjust this control since the built-in Auto Tape Selector automatically adjusts the recording bias for different tape types.

However, if you feel that your recording needs further bias adjustment (to compensate for absent or distorted high frequencies), adjust this control to your liking.

When distortion is noticeable, attenuate the high frequencies.

BIAS ADJUST

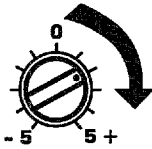

When high frequencies are absent, boost the high frequencies.

BIAS ADJUST

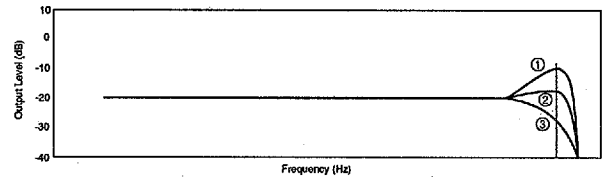
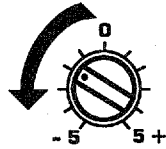

- ① Insufficient bias (Distortion is noticeable.)
- ② Optimum bias
- ③ Excessive bias (High frequencies are absent.)

Setting the recording level (in step 3)

Play the loudest passage of the source to be recorded and watch the meter readings. Adjust the REC LEVEL control so that the highest peak is between +3 dB and +8 dB. Normally, it is best to adjust the BALANCE control such that the LEFT and RIGHT meter readings are even.

- The mark indicates the Dolby noise reduction system standard level.

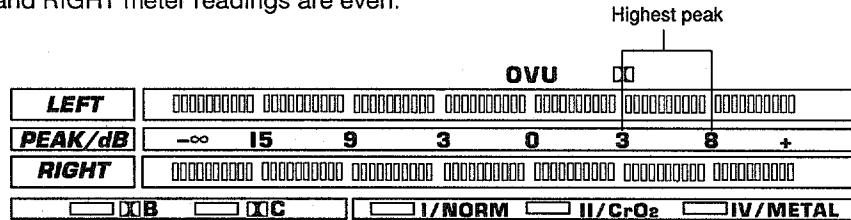

Rec mute operation - Inserting a blank space during recording

During recording

MUTE/SEARCH

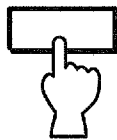

A 4-second blank interval is automatically recorded on the tape, and then the deck enters Rec/Pause mode. If a blank interval longer than 4 seconds is desired, keep pressing for as long as you want. When the MUTE/SEARCH button is released, the deck enters Rec/Pause mode after making a 4-second blank interval.

Rec Return operation - To return to the point at which the recording previously started

During recording



DOLBY HX PRO DYNAMIC BIAS SERVO SYSTEM

This unit incorporates the Dolby HX Pro system which automatically controls the effective bias to reduce distortion and noise, improving high frequency response during recording. Tapes recorded with this system retain the same high quality even when played back on any other cassette deck.

Dolby noise reduction and HX Pro headroom extension manufactured under license from Dolby Laboratories Licensing Corporation, HX Pro originated by Bang & Olufsen.

"DOLBY", the double-D symbol and "HX PRO" are trademarks of Dolby Laboratories Licensing Corporation.

TIMER RECORDING/PLAYBACK

With a commercially available audio timer it is possible to make recordings and initiate playback at any time automatically.

Make sure that all power cord connections between the timer and amplifier/receiver are properly made.

For details, refer to the instructions of your audio timer. No change in any of the other connections between the deck and amplifier/receiver, etc., is necessary.

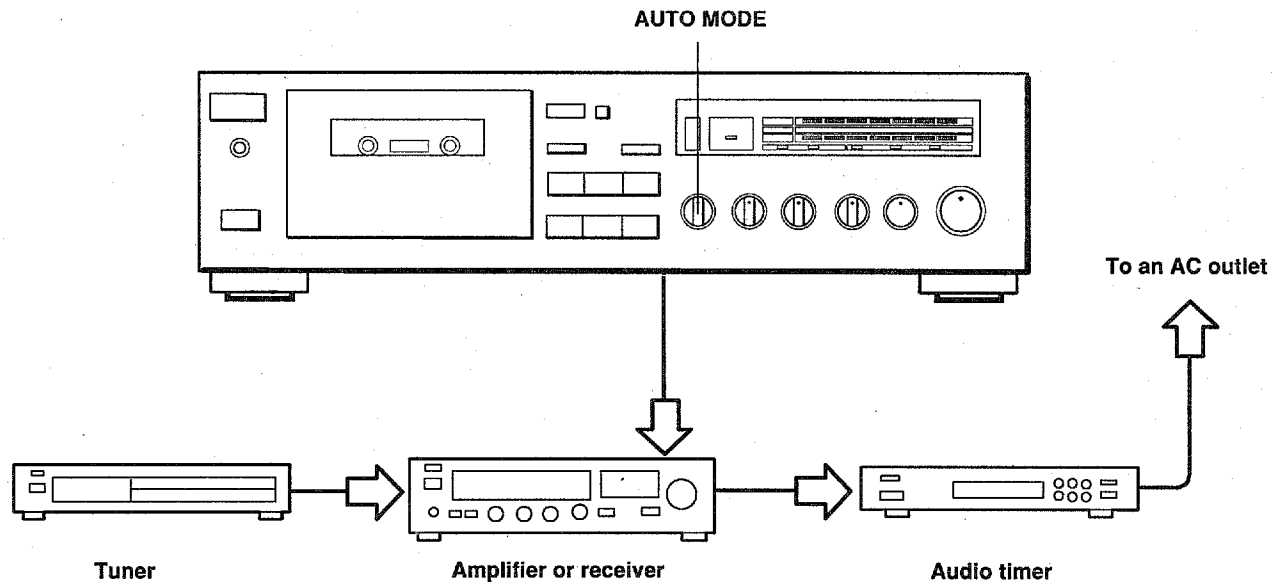

Timer recording

1. After turning on the power to each component, select the station on your tuner which you want to record and turn down the volume on your amplifier/receiver. This will have no effect on the recording signal level. Remember to set the proper recording level.
2. Set the timer to the desired recording start and stop times. It is advisable to set the timer to begin recording slightly before and end slightly after the actual broadcast receiving time to leave some room for later editing.
3. Set the AUTO MODE selector to the TIMER REC position.



4. The timer will send power to the amplifier/receiver, tuner, and deck at the preset time, turning all the components on and initiating the recording. It will shut power off at the preset stop time.

Timer playback

1. Turn on the amplifier/receiver and adjust the volume and tone controls.
2. Set the input mode selector of your amplifier/receiver to the cassette deck function mode.
3. Set the timer to the time you wish to start and stop playback.
4. Set the AUTO MODE selector to the TIMER PLAY position.

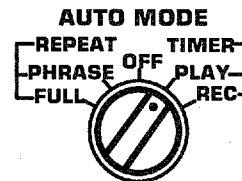

5. At the preset time, the timer will turn power on to the amplifier/receiver and cassette deck and begin playback.

CASSETTE TAPES

CASSETTE TAPES

There are many different types of cassette tapes available, however, they all conform to standard specifications so any brand may be used with the deck.

* YAMAHA does not recommend the use of 120 minute length cassettes since the extreme thinness of the tape makes them susceptible to mechanical and recording problems.

- Classification of Cassette Tapes by Formulation
Cassette tapes are available in four basic types depending on their formulation, or type of magnetic material and manufacturing process. These four types are commonly known as Normal (Type I/NORM), Chrome (Type II/CrO₂), Ferrichrome (Type III/FeCr), and Metal (Type IV/METAL), and they each require specific tape deck adjustments for optimum performance.

AUTO TAPE SELECTOR DETECTION SLOTS

The deck has a built-in Auto Tape Selector which automatically adjusts for the proper bias, level and equalization according to the tape formulation — all you have to do is load a cassette and the Auto Tape Selector does the rest.

The Auto Tape Selector determines what type of tape is loaded by sensing detector slots in the top of a tape shell. Each tape formulation has its own characteristic hole markings which has been standardized by the tape industry.

- Early model Metal (Type IV/Metal) tape formulation cassette shells do not have the slots for Auto Tape Selector operation. As a result, early model Metal type tapes recorded on another deck will be played back with the deck at the Chrome (Type II/CrO₂) settings. YAMAHA does not recommend recording with this kind of tape on the deck.
- The deck does not have the required setting for Ferrichrome (Type III/FeCr) tape, since this tape formulation is not widely used. Should you use a Ferrichrome tape, it will be recorded and played back at the Normal (Type I/NORM) settings. And this will result in an unnatural high frequency emphasis. This effect may be compensated for somewhat by adjusting the BIAS ADJUST to the plus (+) direction during recording, or by using the PLAY TRIM tone control and/or the tone controls of your amplifier/receiver during playback.

TYPE II

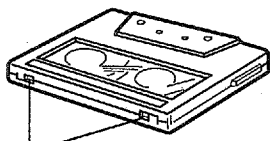

Detector slots

TYPE IV

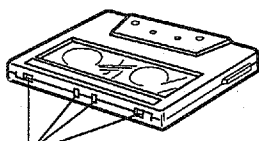

Detector slots

PROTECTING YOUR RECORDINGS

All cassette tapes are provided with erasure protection holes to prevent accidental erasure of recorded contents. There is a small tab covering the hole on each cassette, and it should be broken off after recording a tape. Without this tab covering the hole, it is impossible to record onto that tape. Thus, you can safely protect a recording for as long as you wish without fear of accidental erasure.

Should you wish to use a cassette tape protected in this way for recording, simply covering the hole with adhesive tape will permit erasure and re-recording.

- When using Chrome (Type II/CrO₂) or Metal (Type IV/METAL) tapes, make sure you do not cover the hole intended for the Auto Tape Selector operation.

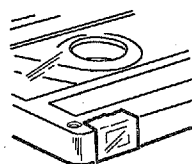
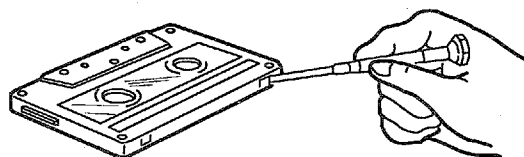

TAKING UP SLACK IN THE TAPE

As a precaution against tape entanglement and damage, before inserting cassettes into the deck, remove any slack in the tape. This is accomplished by inserting a pencil, pen or similar object into one of the spools and gently winding it until all the slack is removed. You do not have to wind it too tightly.

Be careful not to touch the tape part itself. It is very delicate and touching it may damage the tape and its recorded contents.

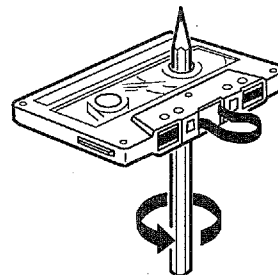

STORING CASSETTES

After putting a cassette tape back into its case, store in a location away from exposure to direct sunlight, humidity, high temperatures, and magnetic fields (away from television sets, speakers, etc.). High temperatures and humidity will damage the tape itself, while exposure to magnetic fields may cause a loss of recorded material. Avoid touching the tape surface with your fingers, since dirt or finger oil will contaminate the deck's heads.

MAINTENANCE

CLEANING OF TAPE PATH

The continued high quality performance of your deck is dependent upon periodic cleaning of the heads, capstan, pinch roller, and all surfaces over which the tape travels. Normal use will cause an accumulation of dirt and dust on the heads, capstans, and pinch rollers. This can lead to poor sound quality, drop outs (intervals with no sound), unsteady tape speed, loss of high frequency response, etc.

Thus, clean the heads and all surfaces over which the tape travels with commercially available cleaning cassette and fluid type cleaners.

Inside of the cassette compartment

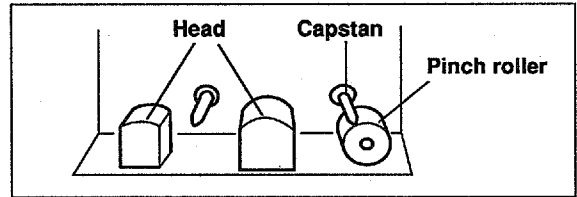

DEMAGNETIZATION

After 20-30 hours of use, enough residual magnetism will have built up on the heads to cause poor high frequency reproduction. At this time you should use a commercially available head demagnetizer.

- When demagnetizing the heads, be sure to follow the instructions of the head demagnetizer carefully.

OPTIONAL REMOTE CONTROL TRANSMITTER

- * The remote control transmitter is available with Australian model.
The keys which have the same names and marks are identical to the buttons on the cassette deck.

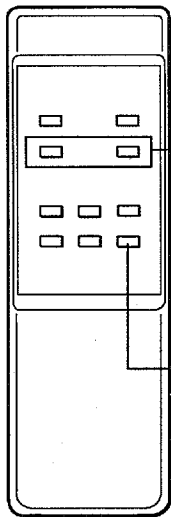

SEARCH keys: By pressing **SEARCH** key, the tape will advance to the beginning of the next selection and begin-play. By pressing **SEARCH** key, the tape will rewind to the beginning of the current selection and begin play.

REC MUTE key: Operates the recording MUTE function of the MUTE/SEARCH button on the deck.

BATTERY INSTALLATION

- ① Press the lid's locking tab down and, at the same time, pull out the battery compartment lid in the direction of the arrow.
- ② Install the batteries (size "AAA", R03) with correct polarities. Follow the diagram in the compartment.
- ③ Position the bottom portion of the compartment lid in place, and push the top portion of the lid in until it clicks into place.

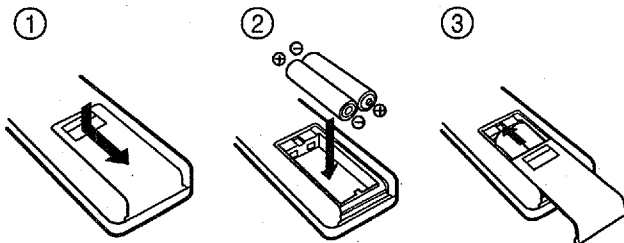

REMOTE CONTROL OPERATION RANGE

The remote control transmitter uses infrared light to control the unit. Therefore, to function properly, there must be a clear, unobstructed path between the transmitter and the sensor on the deck. The normal operating range is about 7 meters (23 feet) and within 30 degrees perpendicular to the front panel.

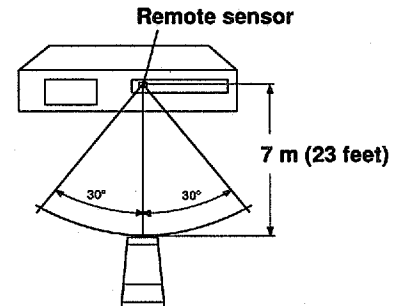

BATTERY REPLACEMENT

When the operating distance of the remote control noticeably decreases, the batteries are exhausted. Immediately replace the batteries with new ones.

- Do not use an old battery together with a new one.
- Install the same type of batteries at the same time. Do not use different kinds of batteries (carbon, alkaline, Ni-Cad, etc.) at the same time even though they are the same shape.
- There are two kinds of batteries in the market: rechargeable and non-rechargeable. Read the caution labels on the battery carefully.

BATTERY SAFETY

Incorrect use of the battery can cause leakage or explosion. Proper handling and use of batteries are as follows:

- When the remote control will not be used for an extended period of time, remove the batteries.
- Never disassemble, heat or throw a battery into a fire.
- Do not connect (short circuit) the (+) and (-) poles of a battery with a piece of wire, metal, etc. In case of leakage, thoroughly wipe off all the electrolyte from the battery compartment and install new batteries.

TROUBLESHOOTING

If your cassette deck fails to operate normally, check the following table. It lists common operating errors and simple measures which you can take to correct the problem. If it cannot be corrected, or the symptom is not listed, disconnect the deck's power cord and contact your local YAMAHA dealer or service center for help.

Fault	Cause	Cure
Tape doesn't move in recording or playback.	<ul style="list-style-type: none"> ● Power plug not properly plugged in. ● End of tape. ● Cassette shell is warped or damaged. 	<ul style="list-style-type: none"> ● Reinsert plug properly. ● Rewind tape or flip it over. ● Do not play damaged tapes.
REC/PAUSE button fails to function.	<ul style="list-style-type: none"> ● No cassette tape loaded. ● Protective tabs are broken off. 	<ul style="list-style-type: none"> ● Load a cassette tape. ● Change tape or cover protective hole with cellophane tape.
Sounds become faint and sometimes inaudible.	<ul style="list-style-type: none"> ● Head is dirty. ● Head is magnetized. ● Tape is damaged or of poor quality. 	<ul style="list-style-type: none"> ● Clean head. ● Demagnetize head using head demagnetizer. ● Change to a different tape.
Recorded sound is distorted.	<ul style="list-style-type: none"> ● Tape is bad (stretched or deformed, etc.). ● Cassette shell is warped. ● Recording level is too high. 	<ul style="list-style-type: none"> ● Replace with a fresh tape. ● A warped cassette shell cannot be fixed. Replace with another tape and test. ● Check input level with signal level meter and use lower rec level when recording.
Tape is playing back, but no sound is heard.	<ul style="list-style-type: none"> ● Faulty connection between deck and stereo amplifier/receiver. 	<ul style="list-style-type: none"> ● Check and secure connections.
Excessive noise.	<ul style="list-style-type: none"> ● Head is dirty. ● Head is magnetized. ● Worn out or poor quality tape. ● Connection(s) improperly made. ● Affected by external electrical noise. 	<ul style="list-style-type: none"> ● Clean head. ● Demagnetize head with head demagnetizer. ● Change to better tape. ● Check input and output connections and reinsert properly. ● Move away from electrical appliances (TV, fluorescent light, electric blanket, etc.).
Excessive wow (wavering of the sound).	<ul style="list-style-type: none"> ● Dirty capstan, pinch roller, etc., or poor tape. ● Tape is wound unevenly. 	<ul style="list-style-type: none"> ● Clean capstan, pinch roller, or change to better tape. ● Rewind tape.
Tape stops in the middle of recording or playback.	<ul style="list-style-type: none"> ● Slack tape, or tape spillage wound around capstan. 	<ul style="list-style-type: none"> ● Insert pencil in hole in cassette shell and turn to take up slack.
Fails to record.	<ul style="list-style-type: none"> ● REC LEVEL control is set too low. ● Protective tabs are broken off. 	<ul style="list-style-type: none"> ● Adjust REC LEVEL control. ● Change tape or cover protective hole with cellophane tape.
Search does not operate.	<ul style="list-style-type: none"> ● Recorded section is too short. ● Recorded section has low-level portions. ● Conversation, etc. has been recorded. 	<ul style="list-style-type: none"> ● Blank sections must be at least 4 seconds long.
High frequencies in the playback sound are emphasized and unpleasant to listen to, and noise level (hiss) is also high.	<ul style="list-style-type: none"> ● Dolby NR-recorded tape is played back in OFF position. 	<ul style="list-style-type: none"> ● Playback in appropriate Dolby NR position.

Fault	Cause	Cure
Playback sound is muffled and high frequencies are inaudible.	<ul style="list-style-type: none"> ● Normally-recorded tape is played back in Dolby NR. ● Heads are dirty. ● Heads are magnetized. 	<ul style="list-style-type: none"> ● Playback in OFF position. ● Clean heads and carry out demagnetization with headdemagnetizer.
When playing back tapes recorded on other decks, meter deflections are greater (smaller) than when recording.	<ul style="list-style-type: none"> ● Basic levels are different for different cassette decks. 	<ul style="list-style-type: none"> ● This is not a fault.
Recordings cannot be made with TIMER REC (deck only plays back).	<ul style="list-style-type: none"> ● Protective tabs on cassette have been broken off. 	<ul style="list-style-type: none"> ● Replace cassette tape, or cover tab holes with tape, etc.

SPECIFICATIONS

Track Configuration	4 track, 2 channel stereo
Motor	DC servo motor (capstan) Flat torque DC motor (reel)
Head	Recording/playback: hard permalloy Erase: double-gap Ferrite head
Rapid Transport	90 sec. (C-60)
Wow and Flutter	
WRMS	less than 0.08%
W.Peak	less than ±0.15%
Signal-to-Noise Ratio	
(Dolby NR off)	better than 58 dB
(Dolby B NR on)	better than 66 dB
(Dolby C NR on)	better than 74 dB
Frequency Response	
Normal tape (-20 dB)	20 ~ 15,000 Hz ±3 dB
CrO₂ tape (-20 dB)	20 ~ 16,000 Hz ±3 dB
Metal tape (-20 dB)	20 ~ 19,000 Hz ±3 dB
Harmonic Distortion	
Normal tape	less than 1.0%
Chrome tape	less than 1.0%
Metal tape	less than 1.0%
Input Sensitivity/Impedance	
Line	70 mV/50 k-ohms
Output Level	
Line	360 mV/1.2 k-ohms
Phones	0.1 mW/8 ohms
Channel Separation (3150 Hz)	40 dB
Cross Talk (125 Hz)	55 dB

GENERAL

Power Supplies

U.S.A. and Canada model 120 V, 60 Hz

Europe model 220 V, 50 Hz

U.K. model and Australia model 240 V, 50 Hz

Other model 110/120/220/240 V, 50/60 Hz

Power Consumption 18 W

Dimensions (W x H x D) 435 x 117 x 273 mm
(17-1/8" x 4-5/8" x 10-3/4")

Weight 4.3 kg (9 lbs. 8 oz.)

Accessories

Output cord 1

Australia model only:

Remote control transmitter 1

Batteries 2

* Specifications subject to change without notice.

YAMAHA

YAMAHA ELECTRONICS CORPORATION, USA 6722 ORANGETHORPE AVE., BUENA PARK, CALIF. 90620, U.S.A.
YAMAHA CANADA MUSIC LTD. 135 MILNER AVE., SCARBOROUGH, ONTARIO M1S 3R1, CANADA
YAMAHA ELECTRONIK EUROPA G.m.b.H. 2084 RELINGEN, BEI HAMBURG, SIEMENSSTR 22/34, F.R. OF GERMANY
YAMAHA ELECTRONIQUE FRANCE S.A. 17 RUE DES CAMPANULES, LOGNES 77321 MARNE LA VALLEE CEDEX 2 FRANCE
YAMAHA ELECTRONICS (UK) LTD. YAMAHA HOUSE, 200 RICKMANSWORTH ROAD WATFORD, HERTS WD1 7JS, ENGLAND
YAMAHA SCANDINAVIA A.B. J A WETTERGRENS GATA 1, BOX 30053, 400 43 VASTRA FRÖLUNDA, SWEDEN
YAMAHA MUSIC AUSTRALIA PTY, LTD. 17-33 MARKET ST., SOUTH MELBOURNE, 3205 VIC., AUSTRALIA

YAMAHA CORPORATION
10-1 NAKAZAWA-CHO, HAMAMATSU, JAPAN
VJ53790-0 BWWB ℓ, b  Printed in Japan