

# Clavinova®

## CLP-240/230

### OWNER'S MANUAL

### BEDIENUNGSANLEITUNG

### MODE D'EMPLOI

### MANUAL DE INSTRUCCIONES

ENGLISH

DEUTSCH

Before using the Clavinova, be sure to read "PRECAUTIONS" on pages 6-7.

Achten Sie darauf, vor Einsatz des Clavinova die "VORSICHTSMASSNAHMEN" auf Seite 6-7 durchzulesen.

Avant d'utiliser le Clavinova, lire attentivement la section «PRECAUTIONS D'USAGE» aux pages 6-7.

Antes de utilizar el Clavinova, lea las "PRECAUCIONES" que debe tener en cuenta en las páginas 6-7.

#### IMPORTANT

—Check your power supply—

Make sure that your local AC mains voltage matches the voltage specified on the name plate on the bottom panel. In some areas a voltage selector may be provided on the bottom panel of the main keyboard unit near the power cord. Make sure that the voltage selector is set for the voltage in your area. The voltage selector is set at 240V when the unit is initially shipped. To change the setting use a "minus" screwdriver to rotate the selector dial so that the correct voltage appears next to the pointer on the panel.

For information on assembling the keyboard stand, refer to the instructions at the end of this manual.

#### WICHTIG

—Überprüfen Sie Ihren Netzanschluss—

Vergewissern Sie sich, dass die Spannung in Ihrem örtlichen Stromnetz mit der Spannung übereinstimmt, die auf dem Typenschild auf der Unterseite des Instruments angegeben ist. In bestimmten Regionen ist auf der Unterseite des Keyboards in der Nähe des Netzkabels ein Spannungswähler angebracht. Vergewissern Sie sich, dass der Spannungswähler auf die Spannung Ihres lokalen Stromnetzes eingestellt ist. Dieser Spannungswähler ist bei Auslieferung auf 240 V eingestellt. Sie können die Einstellung mit einem Schlitzschraubenzieher ändern. Drehen Sie dazu den Wählschalter, bis der Pfeil auf dem Instrument auf die richtige Spannung zeigt.

Weitere Informationen über die Montage des Keyboard-Ständers erhalten Sie in den Anweisungen am Ende dieses Handbuchs.

#### IMPORTANT

—Contrôler la source d'alimentation—

Vérifiez que la tension spécifiée sur le panneau inférieur correspond à la tension du secteur. Dans certaines régions, l'instrument peut être équipé d'un sélecteur de tension situé sur le panneau inférieur du clavier à proximité du cordon d'alimentation.

Vérifiez que ce sélecteur est bien réglé en fonction de la tension secteur de votre région. Le sélecteur de tension est réglé sur 240 V au départ d'usine. Pour modifier ce réglage, utilisez un tournevis à lame plate pour tourner le sélecteur afin de mettre l'indication correspondant à la tension de votre région vis à vis du repère triangulaire situé sur le panneau.

Pour obtenir des informations sur l'assemblage du support du clavier, reportez-vous aux instructions à la fin de ce manuel.

#### IMPORTANTE

—Verifique la alimentación de corriente—

Asegúrese de que tensión de alimentación de CA de su área corresponde con la tensión especificada en la placa de características del panel inferior. En algunas zonas puede haberse incorporado un selector de tensión en el panel inferior de la unidad del teclado principal, cerca del cable de alimentación. Asegúrese de que el selector de tensión esté ajustado a la tensión de su área. El selector de tensión se ajusta a 240V cuando la unidad sale de fábrica. Para cambiar el ajuste, emplee un destornillador de cabeza "recta" para girar el selector de modo que aparezca la tensión correcta al lado del indicador del panel.

Para información sobre el montaje del soporte del teclado, consulte las instrucciones al final de este manual.

FRANÇAIS

ESPAÑOL

EN  
DE  
FR  
ES

# SPECIAL MESSAGE SECTION

**PRODUCT SAFETY MARKINGS:** Yamaha electronic products may have either labels similar to the graphics shown below or molded/stamped facsimiles of these graphics on the enclosure. The explanation of these graphics appears on this page. Please observe all cautions indicated on this page and those indicated in the safety instruction section.

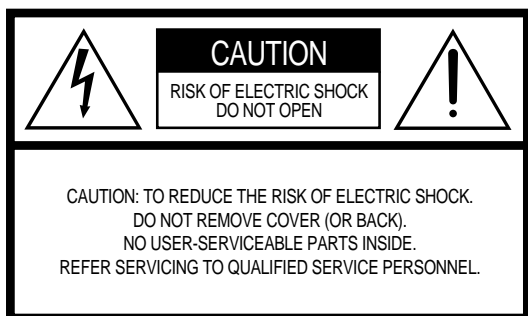

See bottom of Keyboard enclosure for graphic symbol markings.



The exclamation point within the equilateral triangle is intended to alert the user to the presence of important operating and maintenance (servicing) instructions in the literature accompanying the product.

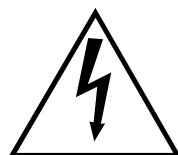

The lightning flash with arrowhead symbol, within the equilateral triangle, is intended to alert the user to the presence of uninsulated “dangerous voltage” within the product’s enclosure that may be of sufficient magnitude to constitute a risk of electrical shock.

**IMPORTANT NOTICE:** All Yamaha electronic products are tested and approved by an independent safety testing laboratory in order that you may be sure that when it is properly installed and used in its normal and customary manner, all foreseeable risks have been eliminated. DO NOT modify this unit or commission others to do so unless specifically authorized by Yamaha. Product performance and/or safety standards may be diminished. Claims filed under the expressed warranty may be denied if the unit is/has been modified. Implied warranties may also be affected.

**SPECIFICATIONS SUBJECT TO CHANGE:** The information contained in this manual is believed to be correct at the time of printing. However, Yamaha reserves the right to change or modify any of the specifications without notice or obligation to update existing units.

**ENVIRONMENTAL ISSUES:** Yamaha strives to produce products that are both user safe and environmentally friendly. We sincerely believe that our products and the production methods used to produce them, meet these goals. In keeping with both the letter and the spirit of the law, we want you to be aware of the following:

**Battery Notice:** This product MAY contain a small non-rechargeable battery which (if applicable) is soldered in place. The average life span of this type of battery is approximately five years. When replacement becomes necessary, contact a qualified service representative to perform the replacement.

**Warning:** Do not attempt to recharge, disassemble, or incinerate this type of battery. Keep all batteries away from children. Dispose of used batteries promptly and as regulated by applicable laws. Note: In some areas, the servicer is required by law to return the defective parts. However, you do have the option of having the servicer dispose of these parts for you.

**Disposal Notice:** Should this product become damaged beyond repair, or for some reason its useful life is considered to be at an end, please observe all local, state, and federal regulations that relate to the disposal of products that contain lead, batteries, plastics, etc.

**NOTICE:** Service charges incurred due to lack of knowledge relating to how a function or effect works (when the unit is operating as designed) are not covered by the manufacturer’s warranty, and are therefore the owners responsibility. Please study this manual carefully and consult your dealer before requesting service.

**NAME PLATE LOCATION:** The graphic below indicates the location of the name plate. The model number, serial number, power requirements, etc., are located on this plate. You should record the model number, serial number, and the date of purchase in the spaces provided below and retain this manual as a permanent record of your purchase.

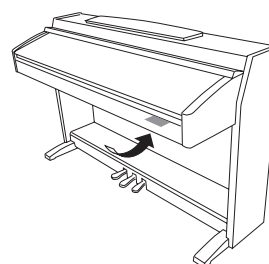

**CLP-240/230**

**Model** \_\_\_\_\_

**Serial No.** \_\_\_\_\_

**Purchase Date** \_\_\_\_\_

Thank you for purchasing the Yamaha Clavinova! We recommend that you read this manual carefully so that you can fully take advantage of the advanced and convenient functions of the Clavinova. We also recommend that you keep this manual in a safe and handy place for future reference.

# About this Owner's Manual

---

This manual consists of three main sections: "Introduction," "Reference" and "Appendix."

## ■ Introduction (page 2):

Please read this section first.

## ■ Reference (page 13):

This section explains how to make detailed settings for the Clavinova's various functions.

## ■ Appendix (page 77):

This section introduces reference material.

- \* The models CLP-240/230 will be referred to as the CLP/Clavinova in this owner's manual.
- \* The illustrations and LED displays shown in this owner's manual are for instructional purposes only and may appear somewhat different from those on your instrument.
- \* The panel illustrations shown in this owner's manual are taken from the CLP-240.
- \* Copying of commercially available software or music data for purposes other than your personal use is strictly prohibited.

### COPYRIGHT NOTICE

This product incorporates and bundles computer programs and contents in which Yamaha owns copyrights or with respect to which it has license to use others' copyrights. Such copyrighted materials include, without limitation, all computer software and MIDI files, etc. Any unauthorized use of such programs and contents outside of personal use is not permitted under relevant laws. Any violation of copyright has legal consequences. DON'T MAKE, DISTRIBUTE OR USE ILLEGAL COPIES.

### Trademarks:

- Apple and Macintosh are trademarks of Apple Computer, Inc.
- Windows is a registered trademark of Microsoft® Corporation.
- SmartMedia is a trademark of Toshiba Corporation.
- All other trademarks are the property of their respective holders.

# Accessories

---

- "50 Greats for the Piano" (Music Book)
- Owner's Manual  
This manual contains complete instructions for operating your Clavinova.
- Accessory CD-ROM for Windows
- Accessory CD-ROM for Windows Installation Guide
- Bench  
A bench may be included or optional, depending on your locale.

## ■ Tuning

Unlike an acoustic piano, the Clavinova does not need to be tuned. It always stays perfectly in tune.

## ■ Transporting

If you move to another location, you can transport the Clavinova along with your other belongings. You can move the unit as it is (assembled) or you can disassemble the unit. Transport the keyboard horizontally. Do not lean it up against a wall or stand it up on its side. Do not subject the instrument to excessive vibration or shock.

# Table of Contents

## Introduction

About this Owner's Manual .....	3
Accessories .....	3
Application Index .....	5
Panel Controls and Terminals.....	8
Before Using the Clavinova .....	10
Key Cover.....	10
Music Rest.....	10
Music Braces (CLP-240) .....	10
Turning the Power On .....	11
Setting the Volume .....	12
Using Headphones .....	12
Using the Speaker Switch .....	12

## Reference

Listening to the Demonstration Tunes.....	14
Listening to 50 Piano Preset Songs .....	15
Practicing a One-Hand Part Using 50 Preset Songs (Part Cancel Function).....	17
A-B Repeat for 50 Preset Songs .....	18
Selecting & Playing Voices.....	19
Selecting Voices .....	19
Using the Pedals.....	20
Adding Variations to the Sound – [VARIATION] (CL P-240)/[BRILLIANCE]/[REVERB]/[EFFECT]/ [DDE] (CLP-240).....	21
Touch Sensitivity – [TOUCH] .....	23
Transposition – [TRANPOSE] .....	24
Combining Two Voices (Dual mode).....	25
Splitting the Keyboard Range and Playing Two Different Voices (Split mode) (CLP-240).....	26
Using the Metronome .....	28
Recording Your Performance .....	29
Recording a performance quickly.....	29
Re-recording a previously recorded song.....	31
Recording to RIGHT/LEFT .....	32
Changing the Initial Settings (Data recorded at the beginning of a song) .....	34
Handling Songs with a USB Storage Device (CLP-240).....	35
About Save and Export.....	35
Saving Songs .....	36
Exporting a Song in SMF format .....	37
Deleting Song Files .....	38
Formatting the USB Storage Device .....	39

Playing Back Songs .....	40
Playing Back User/External Songs on the Instrument .....	41
Playing Back User Files from a USB Storage Device (CL P-240) .....	42
Playing Back SMF/External songs from a USB storage device (CLP-240).....	43
Useful Playback Functions.....	43
Detailed Settings – [FUNCTION].....	44
Basic Procedure in Function Mode.....	45
About Each Function .....	47
F1. Fine Tuning of the Pitch.....	47
F2. Selecting a Scale.....	48
F3. Dual Mode Functions .....	49
F4. (CLP-240) Split Mode Functions.....	50
F5. (CLP-240) / F4. (CLP-230) Other Functions .....	51
F6. (CLP-240) / F5. (CLP-230) Metronome Volume .....	52
F7. (CLP-240) / F6. (CLP-230) Song Part Cancel Volume.....	52
F8. (CLP-240) / F7. (CLP-230) MIDI Functions .....	52
F9. (CLP-240) / F8. (CLP-230) Backup Functions.....	55
F9.5 (CLP-240)/ F8.5 (CLP-230) Character Code .....	55
Connections .....	56
Connectors .....	56
Connection to a USB storage device (CLP-240) .....	58
Connecting a Personal Computer .....	60
Data Backup .....	62
Message List .....	63
Troubleshooting.....	64
Options.....	64
CLP-240/230: Keyboard Stand Assembly .....	65
Handling the Floppy Disk Drive (FDD) and Floppy Disks (CLP-240) .....	69
Installing the Floppy Disk Drive (Optional).....	70
Preset Voice List .....	71
Demo Song List .....	74
Index.....	75

## Appendix

Factory Setting List .....	78
MIDI Data Format .....	80
MIDI Implementation Chart .....	84
Specifications .....	85

# Application Index

---

Use this index to find reference pages that may be helpful for your particular application and situation.

## Listening

---

- Listening to demo songs with different voices..... “Listening to the Demonstration Tunes” on page 14
- Listening to songs from “50 Greats for the Piano” ..... “Listening to 50 Piano Preset Songs” on page 15
- Listening to my recorded performance..... “Playing Back Songs” on page 40
- Listening to songs in the USB storage device ..... “Playing Back Songs” on page 40

## Playing

---

- Using the three performance control pedals ..... “Using the Pedals” on page 20
- Simulating the natural sustain created by the damper pedal on a real grand piano ..... “[DDE]” (CLP-240) on page 22
- Playing an accompaniment that matches pitch..... “Transposition – [TRANPOSE]” on page 24
- Selecting a touch sensitivity type..... “Touch Sensitivity – [TOUCH]” on page 23
- Fine tuning the pitch of the entire instrument when you play the Clavinova along with other instruments or CD music  
..... “Fine tuning of the pitch” on page 47

## Changing voices

---

- Viewing the list of voices ..... “Preset Voice List” on page 71
- Combining two voices ..... “Combining Two Voices (Dual mode)” on page 25
- Playing different sounds with left and right hands  
..... “Splitting the Keyboard Range and Playing Two Different Voices (Split mode) (CLP-240)” on page 26
- Making the sound more brilliant or mellower ..... “[BRILLIANCE]” on page 21
- Simulating a concert hall ..... “[REVERB]” on page 21
- Adding spread or swell to the sound..... “[EFFECT]” on page 22
- Enhancing the sound with effects ..... “[VARIATION]” (CLP-240) on page 21

## Practicing

---

- Muting the right- or left-hand part..... “Practicing a One-Hand Part Using 50 Preset Songs (Part Cancel Function)” on page 17
- Practicing a specified phrase repeatedly ..... “A-B Repeat for 50 Preset Songs” on page 18
- Practicing with an accurate and steady tempo ..... “Using the Metronome” on page 28
- Practicing using your recorded song..... “Recording Your Performance” on page 29

## Recording

---

- Recording your performance..... “Recording Your Performance” on page 29

## Settings

---

- Adjusting the Clavinova settings ..... “Detailed Settings – [FUNCTION]” on page 44

## Connecting the Clavinova to other devices

---

- What is MIDI? ..... “About MIDI” on page 57
- Making detailed settings for MIDI ..... “MIDI Functions” on page 52
- Recording your performance..... “AUX OUT [L] [R] (LEVEL FIXED) jacks” on page 56
- Raising the volume..... “AUX OUT [L] [R] (LEVEL FIXED) jacks” on page 56
- Outputting other instruments’ sound from the Clavinova ..... “AUX IN [L/L+R] [R] jacks” on page 57
- Connecting to a USB storage device ..... “Connection to a USB storage device (CLP-240)” on page 58
- Connecting a computer ..... “Connecting a Personal Computer” on page 60

## Assembling

---

- Assembling and disassembling the Clavinova ..... “CLP-240/230: Keyboard Stand Assembly” on page 65

# PRECAUTIONS

## PLEASE READ CAREFULLY BEFORE PROCEEDING

\* Please keep this manual in a safe place for future reference.

### **WARNING**

Always follow the basic precautions listed below to avoid the possibility of serious injury or even death from electrical shock, short-circuiting, damages, fire or other hazards. These precautions include, but are not limited to, the following:

#### **Power supply/Power cord**

- Only use the voltage specified as correct for the instrument. The required voltage is printed on the name plate of the instrument.
- Check the electric plug periodically and remove any dirt or dust which may have accumulated on it.
- Use only the supplied power cord/plug.
- Do not place the power cord near heat sources such as heaters or radiators, and do not excessively bend or otherwise damage the cord, place heavy objects on it, or place it in a position where anyone could walk on, trip over, or roll anything over it.

#### **Do not open**

- Do not open the instrument or attempt to disassemble the internal parts or modify them in any way. The instrument contains no user-serviceable parts. If it should appear to be malfunctioning, discontinue use immediately and have it inspected by qualified Yamaha service personnel.

#### **Water warning**

- Do not expose the instrument to rain, use it near water or in damp or wet conditions, or place containers on it containing liquids which might spill into any openings.
- Never insert or remove an electric plug with wet hands.

#### **Fire warning**

- Do not put burning items, such as candles, on the unit. A burning item may fall over and cause a fire.

#### **If you notice any abnormality**

- If the power cord or plug becomes frayed or damaged, or if there is a sudden loss of sound during use of the instrument, or if any unusual smells or smoke should appear to be caused by it, immediately turn off the power switch, disconnect the electric plug from the outlet, and have the instrument inspected by qualified Yamaha service personnel.

### **CAUTION**

Always follow the basic precautions listed below to avoid the possibility of physical injury to you or others, or damage to the instrument or other property. These precautions include, but are not limited to, the following:

#### **Power supply/Power cord**

- When removing the electric plug from the instrument or an outlet, always hold the plug itself and not the cord. Pulling by the cord can damage it.
- Remove the electric plug from the outlet when the instrument is not to be used for extended periods of time, or during electrical storms.
- Do not connect the instrument to an electrical outlet using a multiple-connector. Doing so can result in lower sound quality, or possibly cause overheating in the outlet.

#### **Assembly**

- Read carefully the attached documentation explaining the assembly process. Failure to assemble the instrument in the proper sequence might result in damage to the instrument or even injury.

#### **Location**

- Do not expose the instrument to excessive dust or vibrations, or extreme cold or heat (such as in direct sunlight, near a heater, or in a car during the day) to prevent the possibility of panel disfiguration or damage to the internal components.
- Do not use the instrument in the vicinity of a TV, radio, stereo equipment, mobile phone, or other electric devices. Otherwise, the instrument, TV, or radio may generate noise.
- Do not place the instrument in an unstable position where it might accidentally fall over.
- Before moving the instrument, remove all connected cables.
- When setting up the product, make sure that the AC outlet you are using is easily accessible. If some trouble or malfunction occurs, immediately turn off the power switch and disconnect the plug from the outlet. Even when the power switch is turned off, electricity is still flowing to the product at the minimum level. When you are not using the product for a long time, make sure to unplug the power cord from the wall AC outlet.



### Connections

- Before connecting the instrument to other electronic components, turn off the power for all components. Before turning the power on or off for all components, set all volume levels to minimum. Also, be sure to set the volumes of all components at their minimum levels and gradually raise the volume controls while playing the instrument to set the desired listening level.

### Maintenance

- In the case of a model with a polished finish, gently remove dust and dirt with a soft cloth. Do not wipe too hard since small particles of dirt can scratch the instrument's finish.
- When cleaning the instrument, use a soft, dry or slightly damp cloth. Do not use paint thinners, solvents, cleaning fluids, or chemical-impregnated wiping cloths.

### Handling caution

- Take care that the key cover does not pinch your fingers, and do not insert a finger or hand in any gaps on the key cover or instrument.
- Never insert or drop paper, metallic, or other objects into the gaps on the key cover, panel or keyboard. If this happens, turn off the power immediately and unplug the power cord from the AC outlet. Then have the instrument inspected by qualified Yamaha service personnel.
- Do not place vinyl, plastic or rubber objects on the instrument, since this might discolor the panel or keyboard.
- In the case of a model with a polished finish, bumping the surface of the instrument with metal, porcelain, or other hard objects can cause the finish to crack or peel. Use caution.
- Do not rest your weight on, or place heavy objects on the instrument, and do not use excessive force on the buttons, switches or connectors.
- Do not use the instrument/device or headphones for a long period of time at a high or uncomfortable volume level, since this can cause permanent hearing loss. If you experience any hearing loss or ringing in the ears, consult a physician.

Yamaha cannot be held responsible for damage caused by improper use or modifications to the instrument, or data that is lost or destroyed.

Always turn the power off when the instrument is not in use.

### Using the bench (If included)

- Do not place the bench in an unstable position where it might accidentally fall over.
- Do not play carelessly with or stand on the bench. Using it as a tool or step-ladder or for any other purpose might result in accident or injury.
- Only one person should sit on the bench at a time, in order to prevent the possibility of accident or injury.
- If the bench screws become loose due to extensive long-term use, tighten them periodically using the included tool.

### Saving data

#### Saving and backing up your data

- The panel settings and certain other types of data will be lost if the power is turned off before they have been saved. Be sure to save (back up) data you want to keep to the internal Flash Memory before turning off the power (page 55). Keep in mind that this data is for temporary backup purposes and may be inadvertently lost due to malfunction or incorrect operation. Make sure to save all your important data to computer for permanent safekeeping (page 62).

# Panel Controls and Terminals

The Yamaha Clavinova CLP-240/230 digital piano provides natural, expressive grand piano sound and playability, and features Yamaha's original "AWM Dynamic Stereo Sampling (CLP-240)/AWM Stereo Sampling (CLP-230)" tone-generation technology for rich, musical voices.

The CLP-240/230 Grand Piano 1 and 2 voices feature samples painstakingly recorded from a full concert grand piano.

The CLP-240 Grand Piano 1 voice features three velocity-switched samples (Dynamic Sampling), special "Sustain Sampling" (page 51) that samples the unique resonance of an acoustic grand piano's soundboard and strings when the damper pedal is pressed, and "Keyoff Samples" that add the subtle sound produced when the keys are released.

The CLP-240/230 also utilizes a "GH3 (Graded Hammer 3)" Keyboard that varies the key weight according to the key range. Moreover, this specially crafted keyboard lets you use techniques only possible on grand pianos, such as playing the same note successively and having the sounds blend smoothly even without use of the damper pedal, or playing the same key quickly and having perfect articulation without the sound cutting off unnaturally. With these features, the CLP-240/230 comes much closer to the sound of a true acoustic piano.

(The panel illustration is taken from the CLP-240)

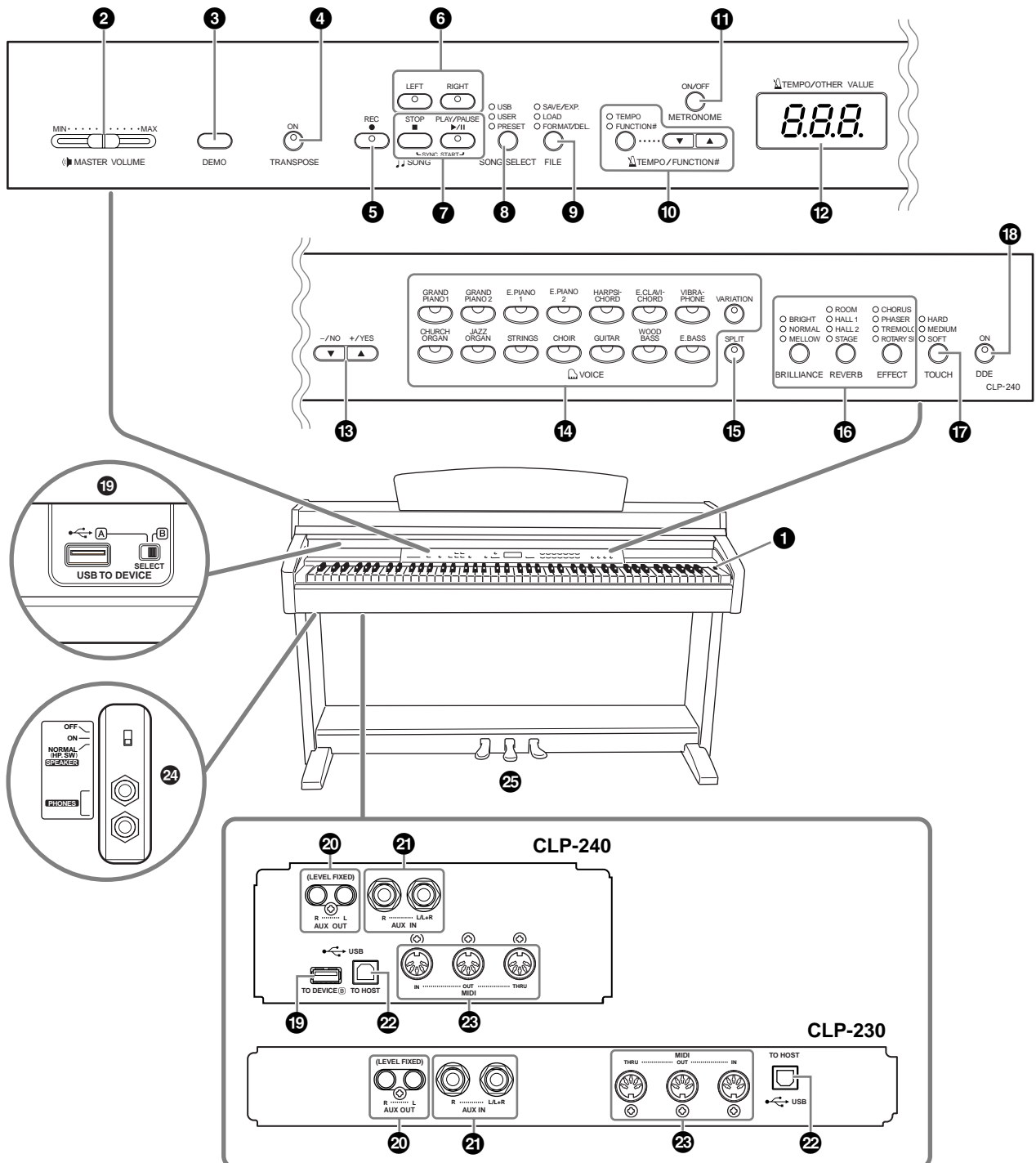



- 1 [POWER] switch** ..... page 11
- 2 [MASTER VOLUME] slider** ..... page 12  
Adjust the volume level using this slider.
- 3 [DEMO] button** ..... page 14  
Demonstration playback is available for each voice.
- 4 [TRANSPOSE] button** ..... page 24  
You can shift the pitch of the entire keyboard up or down so that the pitch will match that of another instrument or singer, while you play the same, unshifted keys.
- 5 [REC] button** ..... page 29  
For recording your keyboard performance.
- 6 [RIGHT], [LEFT] buttons** ..... pages 17, 32  
For turning the left- and right-hand parts on or off as required so you can practice the corresponding part (the part that is turned off) on the keyboard.
- 7 [PLAY/PAUSE], [STOP] buttons**  
..... pages 15, 41  
For playing back the preset songs, your recorded material or commercially available music data, etc.
- 8 [SONG SELECT] button** ..... pages 15, 41  
For selecting a song to play back or edit.
- 9 [FILE] button (CLP-240)** ..... pages 35, 42  
For saving recorded songs and managing song files. Also lets you format a USB storage device.
- 10 [TEMPO/FUNCTION#] button**  
..... pages 28, 45  
For changing the song tempo (speed) and selecting other useful functions (pages 44-55).
- 11 [METRONOME] button** ..... pages 28, 52  
For using the metronome.
- 12 Display** ..... page 11
-  **CAUTION**  
Do not turn off the power to the instrument while flashing dashes appear in the display (indicating the operation is in process). Doing so may damage the data.
- 13 [-/NO], [+ /YES] buttons**  
For setting values or performing file operations. Pressing both buttons simultaneously for certain value settings (Transpose, Tempo, etc.) restores the default value.
- 14 Voice group buttons** ..... page 19  
For selecting voices from 14 internal sounds including Grand Piano 1 and 2. You can also combine two voices and use them together. (Only the CLP-240 has the [VARIATION] button.)
- 15 [SPLIT] button (CLP-240)** ..... page 26  
For playing different voices on the left- and right-hand sections of the keyboard.
- 16 [BRILLIANCE], [REVERB], [EFFECT] buttons** ..... page 21  
For adjusting the brightness of the sound and adding reverb and chorus effects to the sound.
- 17 [TOUCH] button** ..... page 23  
For fine-tuning the touch response.
- 18 [DDE] button (CLP-240)** ..... page 22  
For turning the DDE (Dynamic Damper Effect) function on or off. When DDE is on, the Clavinova simulates the sustain sound that occur when you press the damper pedal of a grand piano, as you press the damper pedal and play the keyboard.
- 19 USB [TO DEVICE] terminals (CLP-240)**  
..... page 57  
For connecting the instrument to a USB storage device, allowing saving/loading of data to and from the connected device. The instrument has two TO DEVICE terminals, A and B, which can be specified using the [SELECT] switch.
- 20 AUX OUT [L] [R] (LEVEL FIXED) jacks**  
..... page 56  
For outputting the sound of the Clavinova to an external audio system, or connecting it to another device (cassette tape recorder, etc.) to record your performance.
- 21 AUX IN [L/L+R] [R] jacks** ..... page 57  
For connecting an external tone generator, allowing you to play the sound of that device via the Clavinova's internal sound system and speakers.
- 22 USB [TO HOST] terminal** ..... page 57  
For connecting the instrument to your computer, allowing you to transfer MIDI data between the Clavinova and the computer.
- 23 MIDI [IN] [OUT] [THRU] terminals**  
..... page 57  
For connecting external MIDI devices, allowing the use of various MIDI functions.
- 24 [PHONES] jacks, [SPEAKER] switch**  
..... page 12  
For connecting a set of standard stereo headphones, allowing private practice. The [SPEAKER] switch turns the internal speakers on or off.
- 25 PEDALS** ..... page 20  
For producing a range of expressive effects similar to those produced by the pedals on an acoustic piano. The left pedal can also be assigned to a variety of functions.

# Before Using the Clavinova

## Key Cover

### To open the key cover:

Lift the cover slightly, then push and slide it open.

### To close the key cover:

Slide the cover toward you and gently lower the cover over the keys.

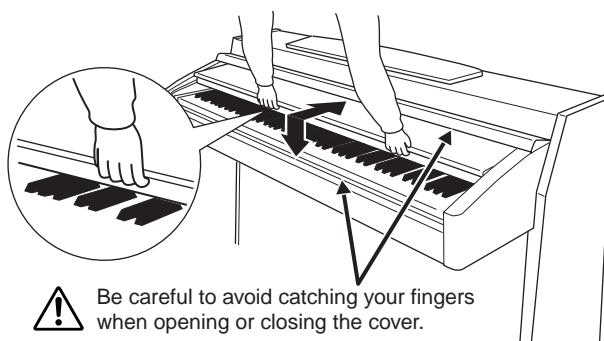

### ⚠ CAUTION

Hold the cover with both hands when opening or closing it. Do not release it until it is fully opened or closed. Be careful to avoid catching fingers (yours or others, especially children's) between the cover and main unit.

### ⚠ CAUTION

Do not place objects such as a piece of metal or paper on top of the key cover. Small objects placed on the key cover may fall inside the unit when the cover is opened and may be nearly impossible to remove. This could cause electric shock, short circuit, fire or other serious damage to the instrument.

### ⚠ CAUTION

Disconnect the optional USB storage device connected to the [USB TO DEVICE] A terminal before closing the key cover. Closing the cover with the device still connected may damage the device.

## Music Rest

### To raise the music rest:

1. Pull the music rest up and toward yourself as far as it will go.
2. Flip down the two metal supports at the left and right on the rear of the music rest.
3. Lower the music rest so that it rests on the metal supports.

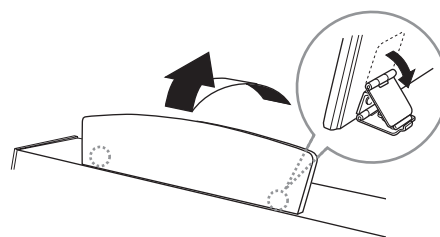

### To lower the music rest:

1. Pull the music rest toward yourself as far as it will go.
2. Raise the two metal supports (at the rear of the music rest).
3. Gently lower the music rest backward until it is all the way down.

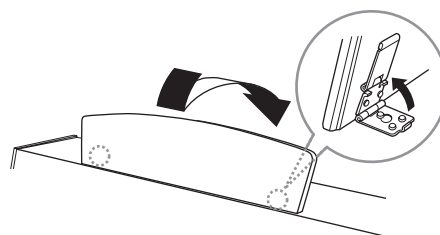

### ⚠ CAUTION

Do not try to use the music rest in a half-raised position. When lowering the music rest, do not release your hands from the music rest until it is all the way down.

## Music Braces (CLP-240)

These braces are for holding the pages of music books in place.

To open

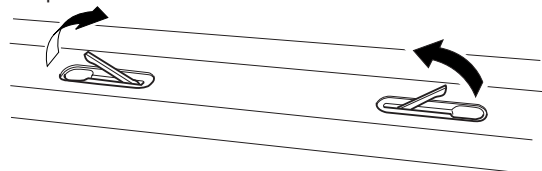

To close

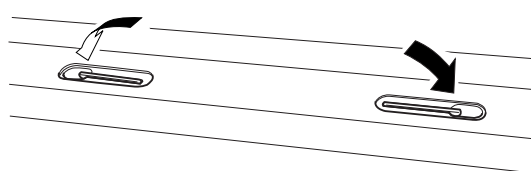

# Turning the Power On

## 1. Connect the power cord.

Insert the plugs at the ends of the cord, one into the AC INLET on the Clavinova, and the other into a standard AC outlet.

In some areas, a plug adaptor may be provided to match the pin configuration of the AC wall outlets in your area.

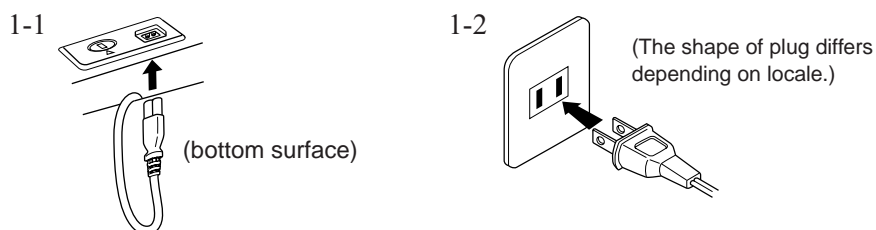

### ⚠ CAUTION

Make sure your CLP-240/230 is rated for the AC voltage supplied in the area in which it is to be used (voltage rating appears on the name plate on the bottom panel). In some areas, a voltage selector may be provided on the bottom panel of the main keyboard unit near the power cord. Make sure that the voltage selector is set for the voltage in your area. Connecting the unit to the wrong AC supply can cause serious damage to the internal circuitry and may even pose a shock hazard!

Use only the AC power cord supplied with the CLP-240/230. If the supplied cord is lost or damaged and needs to be replaced, contact your Yamaha dealer. The use of an inappropriate replacement can pose a fire and shock hazard!

The type of AC power cord provided with the CLP-240/230 may be different depending on the country in which it is purchased. (In some areas a plug adaptor may be provided to match the pin configuration of the AC wall outlets in your area.)

Do NOT modify the plug provided with the CLP-240/230. If the plug will not fit the outlet, have a proper outlet installed by a qualified electrician.

## 2. Turn the power on.

Press the **[POWER]** switch.

- The display located in the center of the front panel and the power indicator located below the left end of the keyboard lights up.

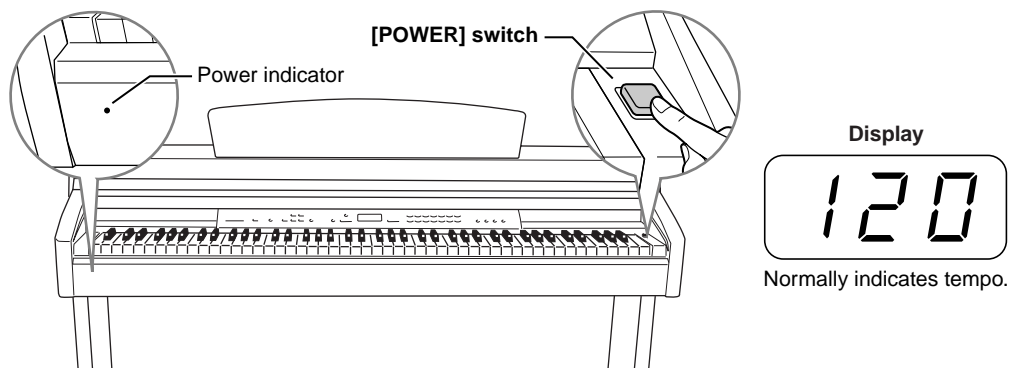

When you're ready to turn off the power, press the **[POWER]** switch again.

- The display and the power indicator turn off.

### NOTE

#### Power indicator

If you close the key cover without turning the power off, the power indicator remains lit, indicating that the power is still on.

## Setting the Volume

Initially set the [MASTER VOLUME] slider about halfway between the “MIN” and “MAX” settings. Then, when you start playing, re-adjust the [MASTER VOLUME] slider to the most comfortable listening level.

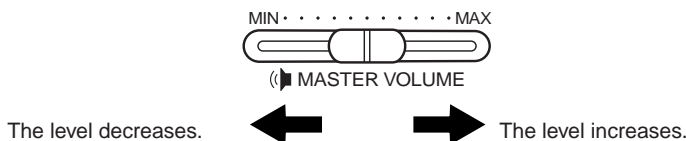

### **CAUTION**

Do not use the Clavinova at a high volume level for a long period of time, or your hearing may be damaged.

#### **TERMINOLOGY** MASTER VOLUME:

The volume level of the entire keyboard sound

#### **NOTE**

You can also adjust the [PHONES] output level and the AUX IN input level using the [MASTER VOLUME] slider.

## Using Headphones

Connect a pair of headphones to one of the [PHONES] jacks.

Two [PHONES] jacks are provided.

You can connect two sets of standard stereo headphones. (If you are using only one pair of headphones, you can plug them into either jack.)

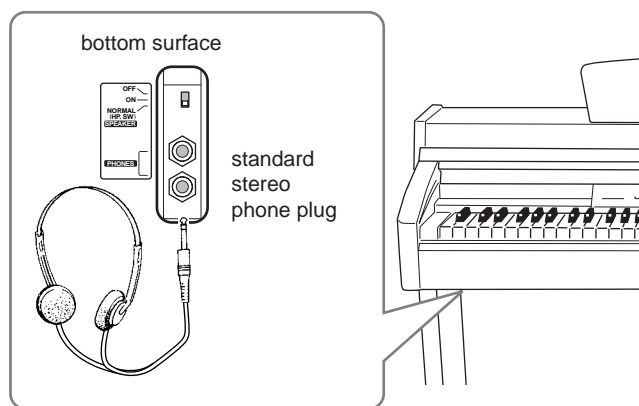

### Using the Headphone Hanger

A headphone hanger is included in the CLP-240/230 package so that you can hang the headphones on the Clavinova. Install the headphone hanger using included two screws (4 × 10mm) as shown in the figure.

### **CAUTION**

Do not hang anything other than the headphones on the hanger. Otherwise, the Clavinova or the hanger may be damaged.

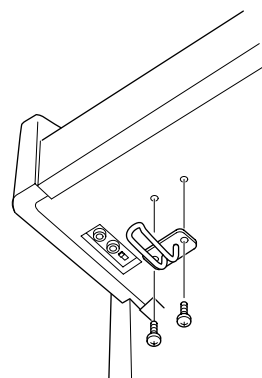

## Using the Speaker Switch

This switch turns the internal speakers on or off.

**NORMAL (HP. SW)** ..... The speakers produce sound as long as a pair of headphones is not connected.

**ON** ..... The speakers always produce sound.

**OFF** ..... The speakers produce no sound.

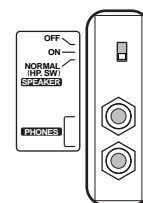

# Reference

This section explains how to make detailed settings for the Clavinova's various functions.

Listening to the Demonstration Tunes .....	14	F2. Selecting a Scale .....	48
Listening to 50 Piano Preset Songs.....	15	F3. Dual Mode Functions.....	49
Practicing a One-Hand Part Using 50 Preset Songs (Part Cancel Function).....	17	F4. (CLP-240) Split Mode Functions.....	50
A-B Repeat for 50 Preset Songs .....	18	F5. (CLP-240)/F4. (CLP-230) Other Functions .....	51
Selecting & Playing Voices .....	19	F6. (CLP-240)/F5. (CLP-230) Metronome Volume .....	52
Selecting Voices .....	19	F7. (CLP-240)/F6. (CLP-230) Song Part Cancel Volume ....	52
Using the Pedals .....	20	F8. (CLP-240)/F7. (CLP-230) MIDI Functions .....	52
Adding Variations to the Sound – [VARIATION] (CLP-240)/[BRILLIANCE]/[REVERB]/[EFFECT]/[DDE] (CLP-240)	21	F9. (CLP-240)/F8. (CLP-230) Backup Functions .....	55
Touch Sensitivity – [TOUCH].....	23	F9.5 (CLP-240)/F8.5 (CLP-230) Character Code .....	55
Transposition – [TRANSCOPE] .....	24	Connections .....	56
Combining Two Voices (Dual mode).....	25	Connectors.....	56
Splitting the Keyboard Range and Playing Two Different Voices (Split mode) (CLP-240) .....	26	Connecting a Personal Computer.....	60
Using the Metronome .....	28	Data Backup .....	62
Recording Your Performance .....	29	Message List.....	63
Recording a performance quickly .....	29	Troubleshooting.....	64
Re-recording a previously recorded song .....	31	Options .....	64
Recording to RIGHT/LEFT .....	32	CLP-240/230: Keyboard Stand Assembly.....	65
Changing the Initial Settings (Data recorded at the beginning of a song) .....	34	Handling the Floppy Disk Drive (FDD) and Floppy Disks (CLP-240) .....	69
Handling Songs with a USB Storage Device (CLP-240) .	35	Installing the Floppy Disk Drive (Optional) .....	70
About Save and Export .....	35	Preset Voice List.....	71
Saving Songs.....	36	Demo Song List.....	74
Exporting a Song in SMF format .....	37	Index .....	75
Deleting Song Files.....	38		
Formatting the USB Storage Device .....	39		
Playing Back Songs .....	40		
Playing Back User/External Songs on the Instrument .....	41		
Playing Back User Files from a USB Storage Device (CLP-240) .....	42		
Playing Back SMF/External songs from a USB storage device (CLP-240) .....	43		
Useful Playback Functions.....	43		
Detailed Settings – [FUNCTION] .....	44		
Basic Procedure in Function Mode.....	45		
About Each Function .....	47		
F1. Fine Tuning of the Pitch .....	47		

# Listening to the Demonstration Tunes

Demonstration tunes are provided that effectively demonstrate each of the CLP-240/230's voices.

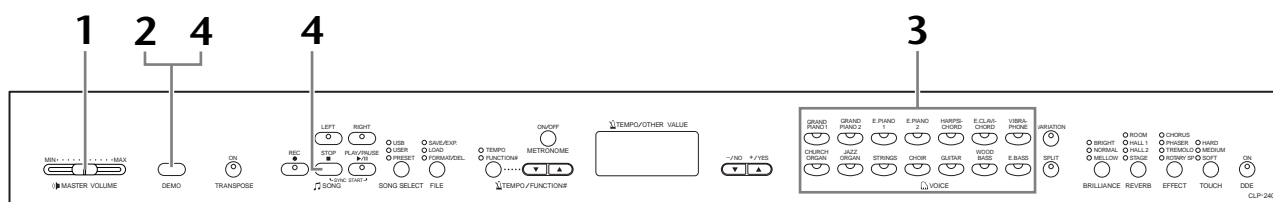

## Procedure

### 1. Turn the power on.

(In case the power is not turned ON) Press the **[POWER]** switch.

When the power is turned ON, one of the voice button LEDs will light.

Initially set the **[MASTER VOLUME]** slider about half way between the “MIN” and “MAX” settings. Then, when you start playing, re-adjust the **[MASTER VOLUME]** slider to the most comfortable listening level.

### 2. Engage Demo mode.

Press the **[DEMO]** button to engage Demo mode. The voice button indicators will flash in sequence.

### 3. Play a Voice demo.

Press one of the voice buttons to start playback of all songs starting from the corresponding voice demo tune — featuring the voice normally selected by that voice button. (If you press the **SONG [PLAY/PAUSE]** button instead of a voice button, the GRAND PIANO 1 demo tune will begin playback.)

### 4. Stop the Voice demo and exit from Demo mode.

Press the **[DEMO]** or **SONG [STOP]** button.

#### NOTE

For a list of the demo songs, see page 74.

#### NOTE

MIDI reception is not possible in Demo Song mode. Demo song data is not transmitted via the MIDI terminals.

#### NOTE

Demo mode cannot be engaged during User song recording (page 29) or file operations (page 35).

#### TERMINOLOGY

##### Mode:

A mode is a status under which you can execute a certain function. In Demo mode, you can play back demonstration tunes.

#### NOTE

You cannot adjust the tempo of demo songs.

You cannot use the part cancel function (page 17) or the song A-B repeat function (page 18) in Demo mode.

#### NOTE

On the CLP-240, you can demo the piano voices with various effects by pressing the **[VARIATION]** button, then pressing the desired voice button. Refer to the “Piano Voice Demo Description” on page 74 for the complete list of demo sounds for the piano voices with various effects.



# Listening to 50 Piano Preset Songs

The Clavinova provides performance data of 50 piano songs. You can simply listen to these songs (page 15) or use them for practice (page 17). You can also refer to the included “50 Greats for the Piano” that contains scores for 50 piano preset songs.

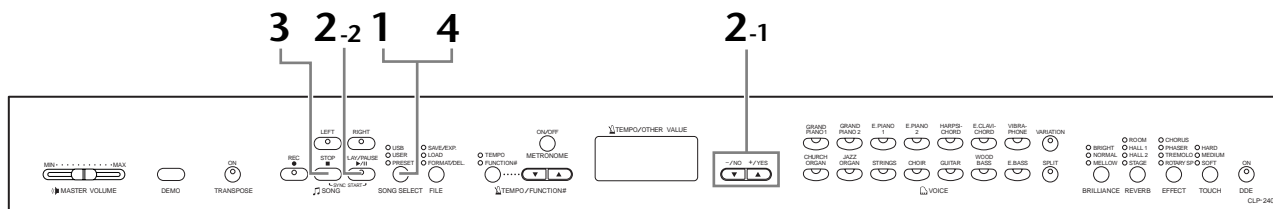

## Procedure

### 1. Engage Preset Song mode.

Press the [SONG SELECT] button a few times until the “PRESET” indicator lights.

### 2. Play any of the 50 preset songs.

**2-1** Press the [-/NO], [+ /YES] buttons to select the number of the tune you want to play (the number will appear on the LED display).

**1 – 50:** Select a preset song number and play only the song.

**ALL:** Play all preset songs in sequence.

**rnd:** Play all preset songs continuously in random order.



song number

**2-2** Press the SONG [PLAY/PAUSE] button to start playback.

#### Adjust the Volume

Use the [MASTER VOLUME] control to adjust the volume.

#### Adjust the tempo

You can use the [TEMPO/FUNCTION# ▼ ▲] buttons to adjust the playback tempo as required. The default tempo can be recalled by simultaneously pressing the [▼] and [▲] buttons.

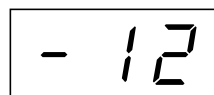

This produces a relative tempo variation, with a range from “-50” through “0” to “50” at maximum; the range will differ depending on the selected song.

### 3. Stop playback.

Playback will stop automatically when the selected preset song has finished. To stop the song during playback (or continuous playback), press the SONG [STOP] button. You can also pause playback by pressing the SONG [PLAY/PAUSE] button.

- To play back another song continuously, see procedure 2 above.

#### NOTE

Preset Song mode cannot be engaged while the unit is in Demo Song mode (page 14) or during song playback (page 41), User song recording (page 29), or file operations (page 35).

#### TERMINOLOGY

##### Song:

On the CLP-240/230, performance data is called a “Song.” This includes demonstration tunes and piano preset tunes.

#### NOTE

You can play the keyboard along with the preset song. You can change the voice playing on the keyboard.

#### NOTE

You can adjust the Brilliance control (page 21) and Reverb type (page 21) that is applied to the voice you play on the keyboard and for the preset song playback. You can change the Effect type (page 22) and Touch sensitivity (page 23) for the keyboard voice.

#### NOTE

The default tempo “0” is automatically selected whenever a new preset song is selected, or when playback of a new preset song begins during “ALL” or “rnd” playback.

#### NOTE

When you select a different song (or a different song is selected during chained playback), appropriate reverb and effect types will be selected accordingly.

## 4. Exit from Preset Song mode.

Press the [SONG SELECT] button to exit Preset Song mode. The indicator turns off, and the unit returns to normal play mode.

### How to use the practice functions

You can turn the left- and right-hand parts on or off as required so you can practice the corresponding part (part cancel function) and continuously repeat a specified phrase within a song (song A-B repeat function). For more information, see pages 17–18.

# Practicing a One-Hand Part Using 50 Preset Songs (Part Cancel Function)

The 50 preset songs have separate left- and right-hand parts on individual parts. You can turn the left- and right-hand parts on or off as required so you can practice the corresponding part (the part that is turned off) on the keyboard. The right-hand part is played by **[RIGHT]** and the left-hand part is played by **[LEFT]**.

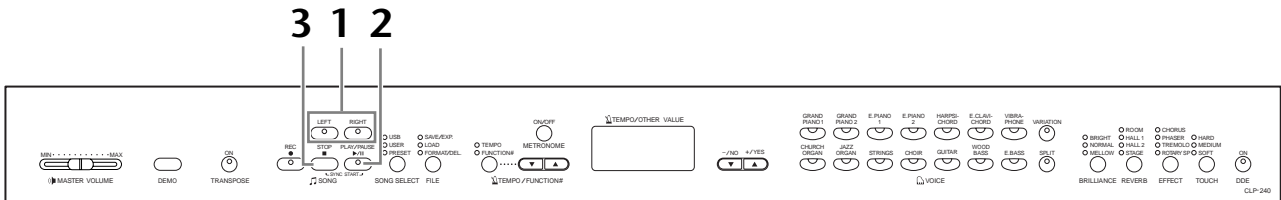

## Procedure

### 1. Turn off the playback part you wish to practice.

After you select a song to practice, press the **[RIGHT]** or **[LEFT]** button to turn off the corresponding part.

When you first select a song, both **[RIGHT]** and **[LEFT]** indicators light up, indicating that you can play back both parts. When you press one of the buttons to turn off playback, the corresponding button indicator turns off and the corresponding part playback is muted.

- Pressing the buttons repeatedly toggles playback between on and off.

### 2. Start playback and playing.

Press the **SONG [PLAY/PAUSE]** button to start playback. Play the part you just turned off.

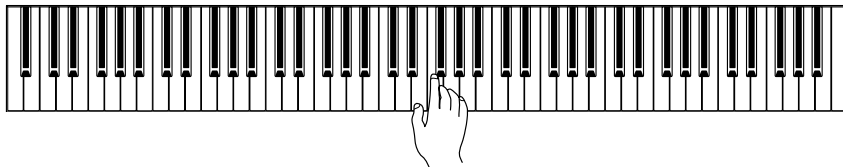

#### Starting playback automatically as you start playing the keyboard (Sync Start)

When the Sync Start function is engaged, playback of the selected preset song will begin automatically as soon as you start playing on the keyboard.

To engage the Sync Start function, simultaneously hold down the **SONG [STOP]** and press the **[PLAY/PAUSE]** button.

(Repeat the previous operation to disengage the Sync Start function.)

Playback will then start as soon as you begin playing on the keyboard.

#### Left Pedal Play/Pause

The left pedal can be assigned to play and pause preset song playback via the "Left Pedal Mode" function described on page 51.

### 3. Stop playback.

When playback is complete, it automatically stops and the Clavinova locates the top of the song. If you wish to stop playback in the middle of a song, press the **SONG [STOP]** button. You can also pause playback by pressing the **SONG [PLAY/PAUSE]** button.

#### NOTE

Appropriate channels in the song will automatically be assigned to **[RIGHT]** and **[LEFT]**. Therefore, **[RIGHT]** may be assigned to a part other than channel 1, or **[LEFT]** to a part other than channel 2.

#### NOTE

The Preset Song Part Cancel function cannot be used during "ALL" or "rnd" (page 15) playback.

#### NOTE

The parts can be turned on or off even during playback.

#### NOTE

The "Song Part Cancel Volume" function described on page 52 can be used to set the canceled part so that it plays at a volume from "0" (no sound) to "20". The normal setting is "5".

#### NOTE

Both parts are automatically turned ON whenever a new song is selected.

# A-B Repeat for 50 Preset Songs

The A-B Repeat function can be used to continuously repeat a specified phrase within a preset song. Combined with the Part Cancel function described below, this provides an excellent way to practice difficult phrases.

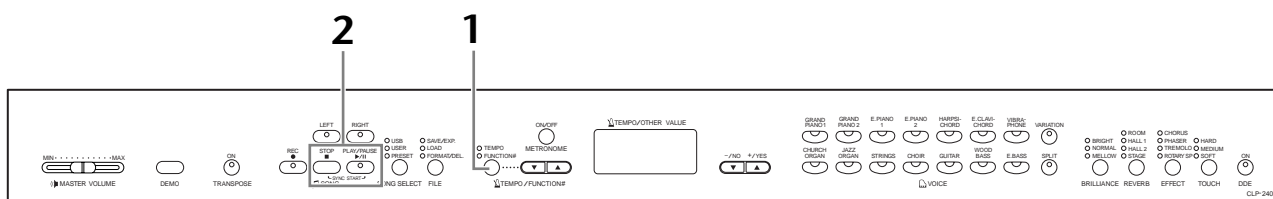

## Procedure

### 1. Specify the beginning (A) and the end (B) of the phrase, and start practicing.

Select and play a preset song, then press the [TEMPO/FUNCTION#] button at the beginning of the phrase you want to repeat.

This sets the “A” point (A - will appear on the display).

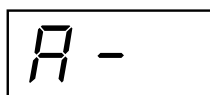

To specify the end (B) of the phrase, press the [TEMPO/FUNCTION#] button a second time at the end of the phrase.

This sets the “B” point (A - b will appear on the display).

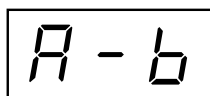

At this point, repeat playback will begin between the specified A and B points.

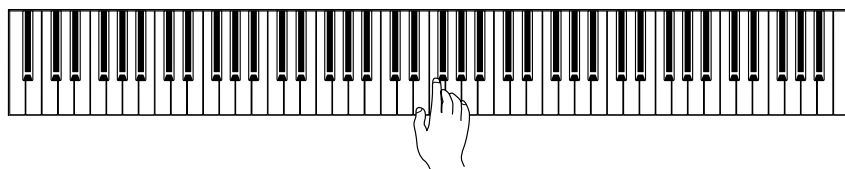

### 2. Stop playback.

Press the SONG [STOP] button to stop playback while retaining the specified A and B points. A-B repeat playback will resume if you press the SONG [PLAY/PAUSE] button.

To cancel the A and B points, press the [TEMPO/FUNCTION#] button once.

#### NOTE

The A-B Repeat function cannot be used during “ALL” or “rnd” (page 15) playback.

#### NOTE

- To set the “A” point at the very beginning of the song, press the [TEMPO/FUNCTION#] button before starting playback.
- You can have the B point automatically be set to the song's end, by setting the A point and letting the song play to the end.

#### NOTE

An automatic lead-in (to help guide you into the phrase) starts at the A point of the song.

#### NOTE

The A and B points are automatically canceled when a new song is selected.

# Selecting & Playing Voices

## Selecting Voices

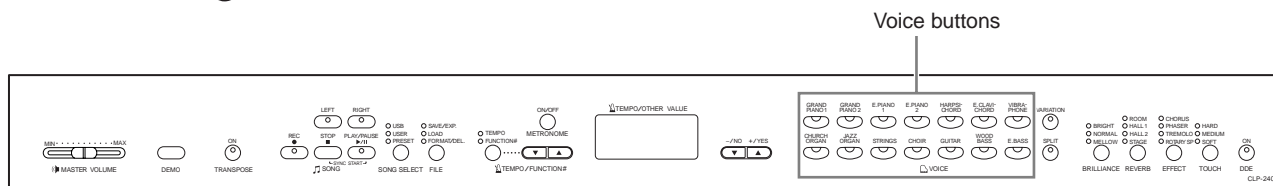

### Procedure

Select the desired voice by pressing one of the Voice buttons.

Then, when you start playing, re-adjust the [MASTER VOLUME] slider for the most comfortable listening level.

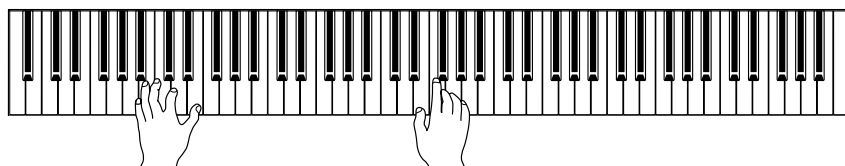

### NOTE

To learn characteristics of the voices, listen to demo songs for each voice (page 14). Refer to “Preset Voice List” on page 71 for more information on the characteristics of each preset voice.

### TERMINOLOGY

#### Voice:

On the Clavinova, a voice means a “tone” or “tonal color.”

### NOTE

You can control the loudness of a voice by adjusting the force with which you strike the keys, although different playing styles (touch sensitivities) have little or no effect with certain musical instruments.

Refer to “Preset Voice List” on page 71.

## Using the Pedals

The Clavinova has three foot pedals that produce a range of expressive effects similar to those produced by the pedals on an acoustic piano.

### Damper (Right) Pedal

The damper pedal functions in the same way as a damper pedal on an acoustic piano. When the damper pedal is pressed, notes sustain longer. Releasing the pedal immediately stops (damps) any sustained notes.

When you select the **GRAND PIANO 1** voice on the CLP-240, pressing the damper pedal activates the instrument's special "Sustain Samples" to accurately recreate the unique resonance of an acoustic grand piano's soundboard and strings. A "half-pedal" effect lets you use the damper pedal to create partial sustain effects, depending on how far down you press the pedal.

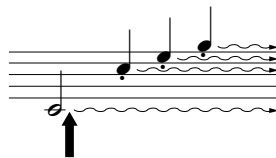
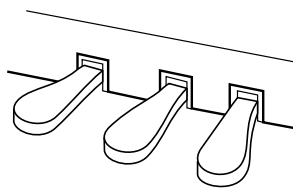

When you press the damper pedal here, the notes you play before you release the pedal have a longer sustain.

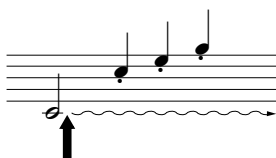

When you press the sostenuto pedal here while holding the note, the note will sustain as long as you hold the pedal.

### Sostenuto (Center) Pedal

If you play a note or chord on the keyboard and press the sostenuto pedal while the note(s) are held, those notes will sustain as long as you hold the pedal (as if the damper pedal had been pressed) but all subsequently played notes will not be sustained. This makes it possible to sustain a chord, for example, while other notes are played "staccato."

### Soft (Left) Pedal

The soft pedal reduces the volume and slightly changes the timbre of notes played while the pedal is pressed. The soft pedal will not affect notes that are already playing when it is pressed.

#### NOTE

If the damper pedal doesn't work, make sure that the pedal cord is properly plugged into the main unit (page 67).

#### NOTE

The depth of the effect produced by the "Sustain Samples" can be adjusted via the "Pedal Functions" (page 51) in Function mode.

#### NOTE

When the DDE effect is on, you can hear a simulation of the sustain sound of the damper pedal on a grand piano, as you press the damper pedal and play the keyboard (page 22).

#### NOTE

Organ, string and choir voices will continue to sound for as long as the sostenuto pedal is depressed.

#### NOTE

The left pedal can be assigned to song play/pause operation or variation function (CLP-240) via the "Left Pedal Mode" described on page 51.





**Procedure**

Pressing the **[REVERB]** button repeatedly toggles the reverb on and off. The indicators light in sequence each time the **[REVERB]** button is pressed. No effect is produced when all indicators are off.

**Adjusting Reverb Depth**

Adjust the reverb depth for the selected voice by using the **[-/NO]** **[+/YES]** buttons while holding the **[REVERB]** button. The depth range is from 0 through 20. The current depth setting appears on the LED display while the **[REVERB]** button is held.

**[EFFECT]**

The **[EFFECT]** button allows you to select an effect to give your sound greater depth and animation.

**OFF:** When no effect is selected, no EFFECT indicator is lit.

**CHORUS:** A shimmering, broadening effect

**PHASER:** Adds a sweeping effect to the sound.

**TREMOLO:** Tremolo effect

**ROTARY SP:** Adds the vibrato effect of a rotary speaker.

**Procedure**

To select an effect type, press the **[EFFECT]** button a few times until the indicator corresponding to the desired type lights (the indicators light in sequence each time you press the **[EFFECT]** button). No effect is produced when all indicators are off.

**Adjusting Effect Depth**

You can adjust the effect depth for the selected voice by using the **[-/NO]** and **[+/YES]** buttons while holding the **[EFFECT]** button.

The depth range is from 0 through 20. The current depth setting appears on the LED display while the **[EFFECT]** button is held.

**[DDE] (CLP-240)**

The DDE (Dynamic Damper Effect) lets you hear a simulation of the sustain sound of the damper pedal on a grand piano, as you press the damper pedal and play the keyboard. This effect is applied to the entire sound of the instrument.

**Procedure**

Pressing the **[DDE]** button repeatedly toggles the DDE on and off.

**Adjusting DDE Depth**

You can adjust the DDE depth by using the **[-/NO]** and **[+/YES]** buttons while holding the **[DDE]** button.

The depth range is from 0 through 20. The current depth setting appears on the LED display while the **[DDE]** button is held.

**NOTE**

Releasing the **[REVERB]** button changes the reverb type. If you are changing the reverb depth by holding the **[REVERB]** button, pressing the **[REVERB]** button will not change the reverb type.

**NOTE**

**Depth 0:** no effect  
**Depth 20:** maximum reverb depth

**NOTE**

Default depth settings are different for each voice.

**NOTE**

The default effect type (including OFF) and depth settings are different for each voice.

**NOTE**

Releasing the **[EFFECT]** button changes the effect type. If you are changing the depth settings by holding the **[EFFECT]** button, pressing the **[EFFECT]** button will not change the effect type.

**NOTE**

**Depth 0:** no effect  
**Depth 20:** maximum effect depth

**NOTE**

Default depth settings are different for each voice.

**NOTE**

Normal setting = ON

**NOTE**

**Depth 0:** no effect  
**Depth 20:** maximum DDE depth

# Touch Sensitivity – [TOUCH]

You can select four different types of keyboard touch sensitivity — HARD, MEDIUM, SOFT or FIXED — to match different playing styles and preferences.

- HARD:** Requires that the keys be played quite hard to produce maximum loudness.
- MEDIUM:** Produces a fairly “standard” keyboard response.
- SOFT:** Allows maximum loudness to be produced with relatively light key pressure.
- FIXED:** All notes are produced at the same volume no matter how hard the keyboard is played. (No indicators are lit.) The fixed volume can be changed.

**NOTE**

This setting does not change the weight of the keyboard.

**NOTE**

Normal setting = MEDIUM

**NOTE**

The touch sensitivity type will become the common setting for all voices. However, the touch sensitivity settings may have little or no effect with certain voices that are not normally responsive to keyboard dynamics. (Refer to the “Preset Voice List” on page 71.)

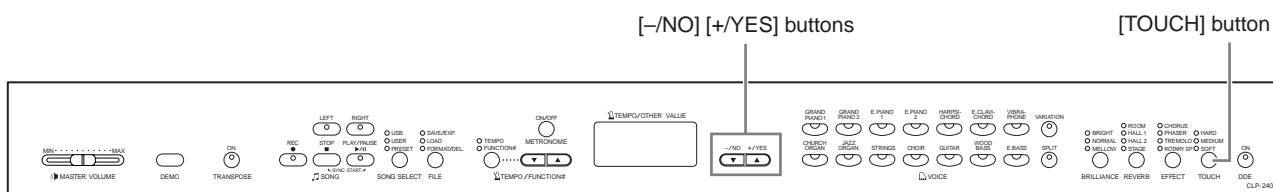

## Procedure

To select a touch sensitivity type press the [TOUCH] button a few times until the indicator corresponding to the desired type lights (the indicators light in sequence each time the [TOUCH] button is pressed). No indicator is lit when “FIXED” is selected.

### Changing the volume when FIXED is selected

When you select FIXED, you can set the volume for notes played in FIXED mode by using the [-/NO] and [+/YES] buttons while you hold the [TOUCH] button. The current volume level appears on the display. The volume range is from 1 through 127. The default setting is 64.

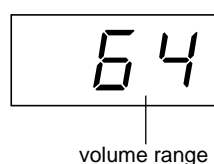

**NOTE**

1: minimum volume  
127: maximum volume

**NOTE**

The touch volume set in FIXED mode will become the common setting for all voices.

**NOTE**

Releasing the [TOUCH] button changes the touch type. If you are changing the volume by holding the [TOUCH] button, pressing the [TOUCH] button will not change the touch sensitivity type. (FIXED mode will remain selected.)

# Transposition – [TRANPOSE]

The Clavinova’s Transpose function makes it possible to shift the pitch of the entire keyboard up or down in semitone intervals to facilitate playing in difficult key signatures, and to let you easily match the pitch of the keyboard to the range of a singer or other instruments. For example, if you set the transposition amount to “5,” playing key C produces pitch F. In this way, you can play a song as though it were in C major, and the Clavinova will transpose it to the key of F.

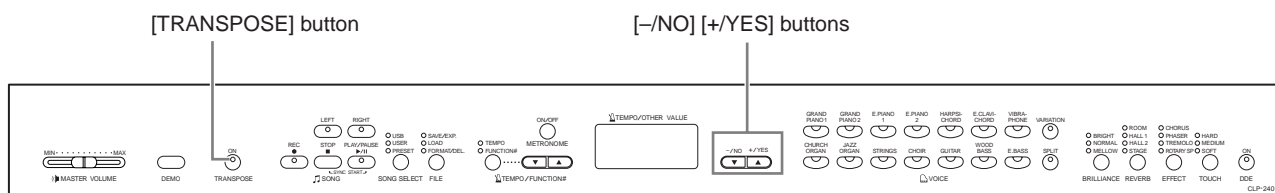

## Procedure

Use the [-/NO] and [+/YES] button while holding the [TRANPOSE] button to transpose down or up as required. The amount of transposition appears on the LED display while the [TRANPOSE] button is held. The default transposition setting is “0”.

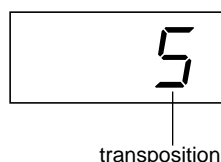

The [TRANPOSE] button indicator remains lit when a transposition setting other than “0” is selected. Every time the [TRANPOSE] button is pressed after that switches the transposition function ON or OFF.

### TERMINOLOGY

**Transpose:** Changing the key signature of a song. On the Clavinova, transposing shifts the pitch of the entire keyboard.

### NOTE

**The transposition range:**  
**-12:** -12 semitones (down one octave)  
**0:** normal pitch  
**12:** 12 semitones (up one octave)

# Combining Two Voices (Dual mode)

You can play two voices simultaneously across the entire range of the keyboard. In this way, you can simulate a melody duet or combine two similar voices to create a thicker sound.

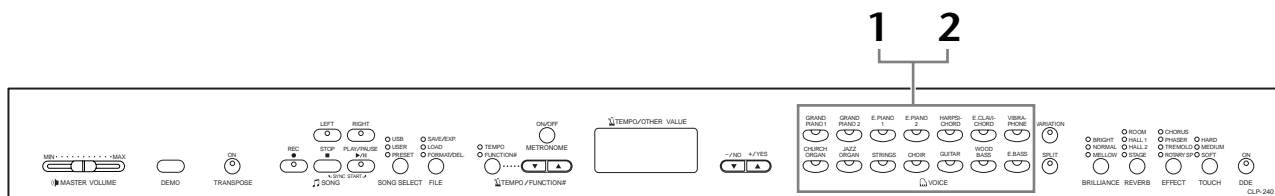

## Procedure

### 1. Engage Dual mode.

Press two voice buttons at the same time (or press one voice button while holding another). The voice indicators of both selected voices will light when Dual mode is active.

- According to the voice numbering priority shown in the diagram on the right, the lower value voice number will be designated as Voice 1 (the other voice will be designated as Voice 2).

Voice numbering priority

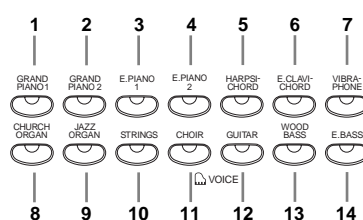

The CLP-240/230 Function mode provides access to a number of other Dual mode functions, such as volume balance setting or octave setting (page 49). (If you do not set Dual mode functions, the appropriate setting will be set in each voice by default.)

### 2. Exit Dual mode and return to normal play mode.

To return to the normal single-voice play mode, press any single voice button.

#### NOTE (CLP-240)

Dual and Split (page 26) modes cannot be engaged at the same time.

#### NOTE

#### [VARIATION] in Dual Mode (CLP-240)

The [VARIATION] button's indicator will light if the variation is engaged for either or both of the Dual mode voices. While Dual mode is engaged, the [VARIATION] button can be used to turn the variation for both voices on or off. To turn the variation on or off for only one of the voices, hold the voice button for the other voice and press the button of the voice for which you want to change the variation.

#### NOTE

#### [REVERB] in Dual Mode

The reverb type assigned to Voice 1 will take priority over the other. (If the reverb is set to OFF, Voice 2 reverb type will be in effect.)

#### NOTE

#### [EFFECT] in Dual Mode

Depending on the conditions, one effect type may take priority over the other. Depth will be decided according to the depth default value of the voice combination. However, using function F3 (page 49) you can adjust the depth value for each voice to your liking.

# Splitting the Keyboard Range and Playing Two Different Voices (Split mode) (CLP-240)

Split mode enables you to play two different voices on the keyboard — one with the left hand and another with the right hand. For example, you can play a bass part using the Wood Bass or Electric Bass voice with the left hand, and a melody with the right hand.

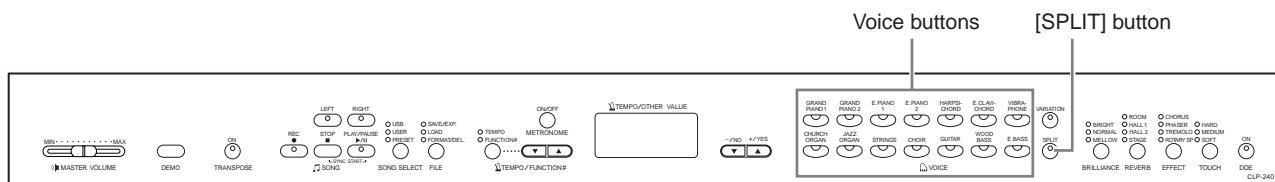

## Procedure

### 1. Engage Split mode.

Press the **[SPLIT]** button so that its indicator lights. The default setting (**WOOD BASS**) will be selected for the left-hand voice at first.

The Function mode provides access to a number of other Split mode functions (page 50). (If you make no settings for Split mode functions, the appropriate setting will be set in each voice by default.)

### 2. Specify the split point (the border between the right-and left-hand range).

(The split point is initially set at the F#2 key by default.)

If you do not need to change the split point, skip this procedure.)

You can change the split point to any other key by pressing the key while holding the **[SPLIT]** button (the name of the current split-point key appears on the LED display while the **[SPLIT]** button is held).

An example of split-point key display

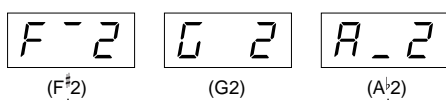

#### NOTE

Dual (page 25) and Split modes cannot be engaged simultaneously.

#### NOTE

A specified "split point" key is included in the left-hand range.

#### NOTE

The split point can also be set via Function 4 (page 50).



### 3. Select a voice for the right hand.

Press a voice button.

### 4. Select a voice for the left hand.

Press the corresponding voice button while holding the **[SPLIT]** button. (The indicator of the Left Voice button will light while the **[SPLIT]** button is pressed.)

To turn the variation on or off for the split voice, hold the **[SPLIT]** button and press the **[VARIATION]** button or the currently-selected voice button.

### 5. Exit Split mode and return to normal play mode.

Press the **[SPLIT]** button again so that its indicator goes out.

#### NOTE

##### **[VARIATION] in Split Mode**

You can turn the variation on or off for Split mode voices. Normally, the voice indicator of the right voice lights in Split mode. The **[VARIATION]** can be used to turn the variation for the right voice on or off as required. While the **[SPLIT]** button is held, however, the voice indicator of the left voice lights. In this state the **[VARIATION]** button turns the variation for the left voice on or off.

#### NOTE

##### **[REVERB] in Split Mode**

The reverb type assigned to the right voice will take priority over the other. (If the reverb is set to OFF, the left voice's reverb type will be in effect.) Reverb depth setting via the panel controls (i.e. pressing the **[-/NO]** or **[+/YES]** buttons while holding the **[REVERB]** button — see page 21) will be applied to the right voice only.

#### NOTE

##### **[EFFECT] in Split Mode**

Depending on the conditions, one effect type will take priority over the other. The depth will be decided according to the depth default value of the voice combination. However, using function F4 (page 50) you can change the depth value for each voice as you like. Effect depth setting via the panel controls (i.e. pressing the **[-/NO]** or **[+/YES]** buttons while holding the **[EFFECT]** button — see page 22) will be applied to the right voice only.

# Using the Metronome

The Clavinova features a built-in metronome (a device that keeps an accurate tempo) that is convenient for practicing.

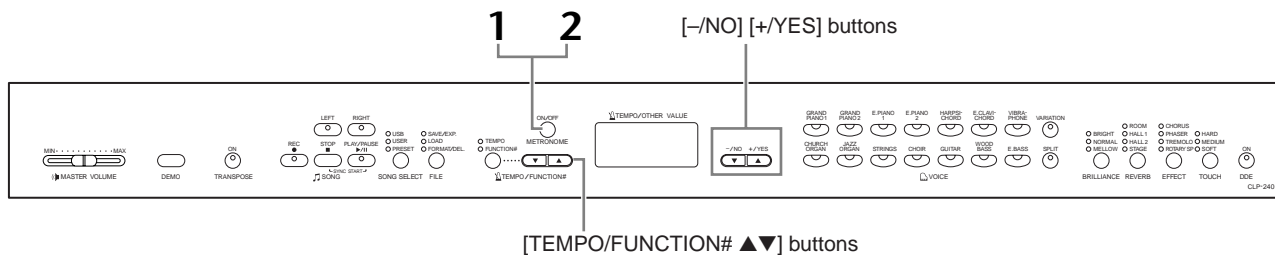

## Procedure

### 1. Start the metronome.

The metronome sound is turned on by pressing the **METRONOME [ON/OFF]** button.

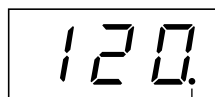

The beat indicator flashes at the current tempo.

#### Adjusting the tempo

The tempo of the metronome and user song recorder playback (the recorder is described in the next section) can be set from 32 to 280 beats per minute by using the **[TEMPO/FUNCTION# ▼, ▲]** buttons (when the **[TEMPO/FUNCTION# ▼, ▲]** button's **[TEMPO]** indicator is lit).

#### Adjusting the time signature

The time signature (beat) of the metronome can be set by using the **[-/NO]** and **[+ /YES]** buttons while holding the **METRONOME [ON/OFF]** button. You can set the beat from 0 to 15. The current setting appears on the LED display while you are holding the **METRONOME [ON/OFF]** button.

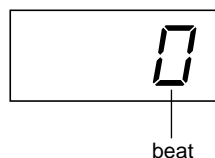

### 2. Stop the metronome.

Turn off the metronome by pressing the **METRONOME [ON/OFF]** button.

#### NOTE

If the **[TEMPO/FUNCTION#]** button's **[FUNCTION#]** indicator is lit, press the **[TEMPO/FUNCTION#]** button to light the **[TEMPO]** indicator.

#### NOTE

The volume of the metronome can be adjusted via the Metronome Volume function in Function mode (page 52).

# Recording Your Performance

The ability to record and play back what you've played on the CLP-240/230 keyboard can be an effective practice aid. You can, for example, record just the left-hand part, and then practice the right-hand part while playing back the recorded left-hand part. Or, since you can record up to two parts separately, you could record the left- and right-hand parts separately, or record both parts of a duet and hear how they sound when played back. The two-part Song Recorder on the CLP-240/230 allows the recording of up to three User songs (U01-U03) to the instrument. On the CLP-240, the User songs can be saved to an optional USB storage device.

## TERMINOLOGY

### Recording vs. Saving:

The format of performance data recorded on a cassette tape differs from that of data recorded on the Clavinova. A cassette tape records audio signals. The Clavinova "saves" information regarding note timing, voices, and a tempo value, but not audio signals. When you play back recorded songs, the Clavinova produces sound based on the saved information. Therefore, recording on the Clavinova may be more accurately called "saving information." However, this book often uses the word "recording" because it seems to make more sense.

## NOTE

You can record your performance (audio data) to a cassette tape recorder or other recording device via the AUX OUT jack (page 56).

## Recording a performance quickly

This convenient and simple recording method lets you quickly record your performance without specifying the recording parts—useful, for example, in recording solo piano pieces.

In this way, the performance is automatically recorded to right part.

## NOTE

When the unit is in Demo Song mode or during a file operation (CLP-240), Record mode cannot be engaged.

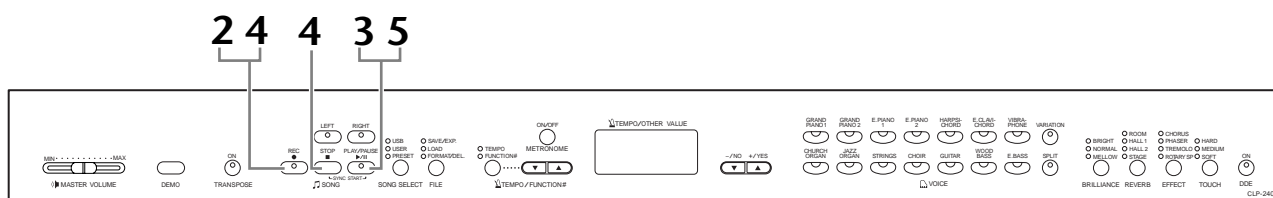

## Procedure

### CAUTION

**To avoid erasing previously recorded song(s):**

If the song contains data, the part indicator lights up green when you select a song. Note that recording new data on this part will erase the existing data.

(CLP-240) You cannot record the performance to the connected USB storage device directly. The recorded songs are saved to the instrument automatically. If you want to save data to the device, perform the Save operation (page 36) after stopping recording.

## 1. Make all the initial settings.

Before you begin to record, select the voice you want to record (or voices if you will be using Dual or Split mode). Make any other desired settings (reverb, effect, etc.) as well. You might also want to set the volume.

You can also adjust the playback volume using the [MASTER VOLUME] slider.

## 2. Engage Record Ready mode.

Press the **[REC]** button to engage Record Ready mode. This automatically selects an empty song for recording and makes the **RIGHT** part active. If an empty song does not exist, Song U01 will be selected. Recording does not actually start yet.

The amount of memory available for recording will be shown on the LED display in approximate kilobytes. The **SONG [PLAY/PAUSE]** indicator will flash at the current **METRONOME** tempo setting.

You can turn on the metronome in this step, and adjust the tempo by using the **[TEMPO/FUNCTION# ▼, ▲]** buttons. (Range: 32-280)

Record Ready mode can be disengaged before recording by pressing the **[REC]** button again.

## 3. Start recording.

Recording will begin automatically as soon as you play a note on the keyboard or press the **SONG [PLAY/PAUSE]** button. The current measure's number will appear on the display while recording.

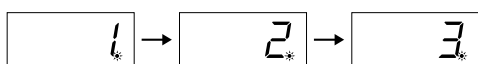

## 4. Stop recording.

Press either **[REC]** or **SONG [STOP]** button to stop recording. When recording is stopped, dashes appear in the display in succession to indicate that the recorded data is being saved to the instrument automatically. After the data is saved, the song name (U01-U03) appears in the display. The recorded part's indicator will glow green to indicate that it now contains data. (Record mode is disengaged automatically.)

### CAUTION

Do not turn off the power of the instrument when dashes appear in the display in succession. Doing so may delete all song data in the instrument, including external songs (page 40).

## 5. Play back the recorded performance.

Press the **SONG [PLAY/PAUSE]** button to play back the recorded performance. To stop playback in the middle of a song, press the **SONG [STOP]** button.

### NOTE

#### The amount of memory available for recording:

This value in kilobytes (a unit used of measurement for data) indicates how much space remains available for recording on the Clavinova. You can record up to a maximum of about 11,000 notes on the CLP-240/230 depending on pedal usage and other factors.

### NOTE

If you have selected the **LEFT** part previously in the same song, the **LEFT** part will automatically be made active when pressing the **[REC]** button in step 2.

### NOTE

If the metronome was on when you started recording, you'll be able to keep time with the metronome while recording, but the metronome sound will not be recorded.

### NOTE

For more recording information, see page 33.

### NOTE

The left pedal can be assigned to start recording via the "Left Pedal Mode" function described on page 51.

### NOTE

The record part indicator will begin to flash when the recorder memory is almost full. If the memory becomes full during recording, "Full" will appear on the display and recording will stop automatically. (All recorded data up to that point will be retained.)

### NOTE

Pressing the **SONG [PLAY/PAUSE]** button to start recording, then pressing the **SONG [STOP]** button to stop recording will erase all previously-recorded data on the selected part.

# Re-recording a previously recorded song

This section explains how to record again in case your performance was not satisfactory.

## Procedure

### 1. Select a voice or voices (and other settings) for recording, if necessary.

Repeat Step 1 on page 29 if you wish to change the previous settings.

### 2. Re-engage Record Ready mode.

Press the [REC] button, again.

The selected part's indicator lights in red.

Follow the procedure from Step 3 in "Recording a performance quickly" on page 30 to re-record.

#### NOTE

If you want to change the tempo, time signature, reverb type, or effect type when re-recording a part or when recording to another part, do so after you engage Record Ready mode.

#### NOTE

You cannot re-record in the middle of a song.

# Recording to RIGHT/LEFT

This lets you record the right and left parts separately. Since you can record the left part while playing back the right, this is useful for recording both parts of a duet.

## Procedure

### 1. Make all the initial settings.

Same as step 1 in “Recording a performance quickly” on page 29.

### 2. Select a song to record.

Press the [SONG SELECT] button to light “USER” indicator on, then press the [-/NO][+/YES] buttons to select a song for recording.

#### CAUTION

To avoid erasing previously recorded song(s):

If the song contains data, the part indicator lights up green when you select a song. Note that recording new data on this part will erase the existing data.

### 3. Engage Record Ready mode.

Press the [REC] button and press the [RIGHT]/[LEFT] button to engage Record Ready mode. Recording does not actually start yet.

The amount of memory available for recording will be shown on the LED display in approximate kilobytes. The SONG [PLAY/PAUSE] indicator will flash at the current METRONOME tempo setting.

Record Ready mode can be disengaged before recording by pressing the [REC] button again.

### 4. Start and stop recording.

Same as step 3-5 in “Recording a performance quickly” on page 30.

#### NOTE

##### Part button indications

**Off:** Contains no data

**On (green):** Contains data

**On (red):** Part is enabled for recording

#### NOTE

##### The amount of memory available for recording:

This value in kilobytes (a unit used of measurement for data) indicates how much space remains available for recording on the Clavinova. You can record up to a maximum of about 11,000 notes on the CLP-240/230 depending on pedal usage and other factors.

#### NOTE

If the metronome was on when you started recording, you'll be able to keep time with the metronome while recording, but the metronome sound will not be recorded.

#### NOTE

If you want to change the tempo, time signature, reverb type, or effect type when rerecording a part or when recording to another part, do so after entering Record Ready mode.

#### NOTE

If you don't want to hear the previously recorded part while you record (for example, when you want to record a song different from what you recorded on the previous part), press the playback part button before pressing the [REC] button so that its indicator is turned off.

#### NOTE

For more information on recording, see page 33.



**The user song recorder records the following data:**

Data in addition to the notes and voices you play is recorded.

This data includes “Individual Parts” and “Entire Song.” See below.

**Individual Parts**

- Notes played
- Voice selection
- [VARIATION] ON/OFF (CLP-240)
- Pedal (Damper/Soft/Sostenuto)
- [REVERB] depth
- [EFFECT] depth
- Dual mode voices
- Dual balance (F3)
- Dual detune (F3)
- Dual octave shift (F3)
- Split mode voices (CLP-240)
- Split balance (F4: CLP-240)
- Split octave shift (F4:CLP-240)

**Entire Song**

- Tempo
- Time signature (beat)
- [REVERB] type (including OFF)
- [EFFECT] type (including OFF)

# Changing the Initial Settings (Data recorded at the beginning of a song)

The initial settings (data recorded at the beginning of a song) can be changed after the recording. For example, after recording, you can change the voice to create a different ambience or adjust the song tempo to your taste.

You can change the following initial settings.

## Individual Parts

- Voice selection
- [VARIATION] ON/OFF (CLP-240)
- [REVERB] depth
- [EFFECT] depth
- Dual mode voices
- Split mode voices (CLP-240)
- Damper/soft pedal depth

## Entire Song

- Tempo
- [REVERB] type (including OFF)
- [EFFECT] type (including OFF)

### 1. Engage Record mode and select a part to change the initial settings.

The indicator glows red. (Data shared by two parts can be changed via either part.)

### 2. Change the settings via the panel controls.

For example, if you wish to change the recorded voice from [E. PIANO 1] to [E. PIANO 2], press the [E. PIANO 2] button. When you wish to change the damper/soft pedal depth, press and hold the pedal.

Be careful not to press the **SONG [PLAY/PAUSE]** button or a key on the keyboard, either of which will start recording and erase all previously-recorded data on the selected part.

### 3. Press the [REC] button to exit Record mode.

Be careful not to press the **SONG [PLAY/PAUSE]** button or a key on the keyboard, either of which will start recording and erase all previously-recorded data on the selected part.

#### NOTE

You can cancel changes made to the initial settings by selecting a different part after Step 2, then exiting Record mode by pressing the **[REC]** button. (Changes made to the data shared by two parts are also canceled.)

# Handling Songs with a USB Storage Device (CLP-240)

You can handle User songs (save, export and delete) with a USB storage device. You can also format the device or media.

## About Save and Export

### Save

You can save three User songs in the instrument to the USB storage device as a single file (User file). These songs can be saved to a “container” (or memory location) in the USB storage device. 100 containers are available — A00-A99.

Since the User songs are saved in a special Clavinova format, they cannot be played back on other instruments, including other Clavinovas.

With this file format, you can re-record each part on the CLP-240. Songs cannot be directly played back from the USB storage device; they must first be loaded to the instrument.

For details on the save operation, see “Saving Songs” on page 36.

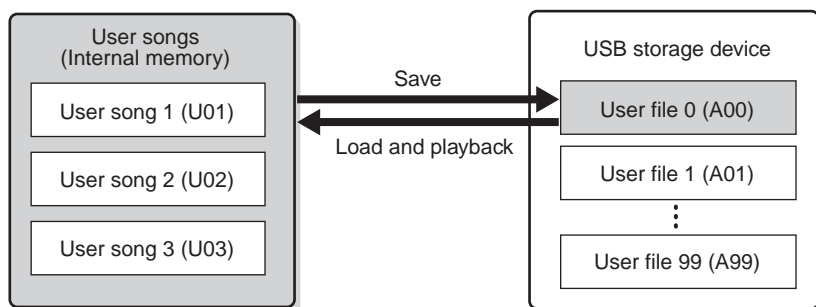

### Export

You can export a User song in the instrument to the USB storage device as a single file (SMF song). Songs can be exported to a “container” (or memory location) in the USB storage device. 100 containers are available — S00-S99.

Since the User songs are saved in SMF format, they can be played back on other instruments, including other Clavinovas.

With this file format, you cannot re-record on the CLP-240. Songs in this format can be directly played back from the USB storage device, and do not need to be previously loaded to the instrument.

For details on the export operation, see “Exporting a Song in SMF format” on page 37.

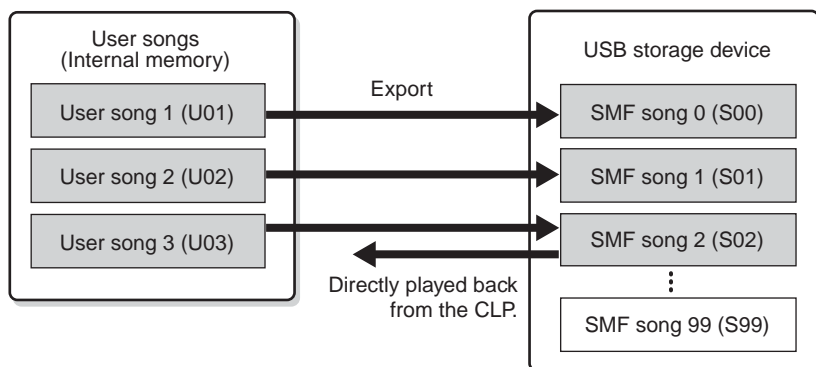

#### NOTE

For details on connecting a USB storage device, see page 58.

#### NOTE

Before handling songs with a USB storage device, make sure that the device is not protected. If the device is protected, you cannot access it.

#### NOTE

If there is not enough capacity left on the USB storage device to save or export the data, an appropriate message will appear on the display and you will not be able to save or export the data. Delete unwanted files from the device to make more memory available (page 38), or use another device.

#### NOTE

The “A” indication at the top of the User file name means “All” — all three songs in the instrument are saved into one container.

#### NOTE

The file numbers which can be handled in this instrument are 100 files.

- User file numbers: A00-A99
- SMF song numbers: S00-S99

#### NOTE

The “S” indication at the top of the SMF song name means “SMF.”

#### TERMINOLOGY

##### SMF (Standard MIDI File):

The SMF (Standard MIDI File) format is one of the most common and widely compatible sequence formats used for storing sequence data. There are two variations: Format 0 and Format 1. A large number of MIDI devices are compatible with SMF Format 0, and most commercially available MIDI sequence data is provided in SMF Format 0. The SMF format for sequence files allows you to exchange song data between different sequencers. User songs recorded on the CLP-240 are exported as SMF Format 0.

# Saving Songs

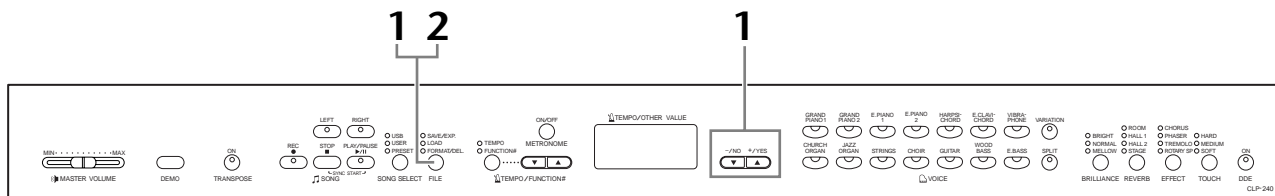

## Procedure

### 1. Select a file container in the device and save the User songs.

After making sure that the USB storage device is connected to the instrument, press the **[FILE]** button (the “SAVE/EXP.” indicator lights). Then, while holding the **[FILE]** button, simultaneously press the **[-/NO][+ /YES]** buttons to select a container (A00-A99). After releasing the **[FILE]** button, “n y” (no/yes) appears in the display. Press the **[+ /YES]** button to save the songs. The file will automatically be saved into the “USERFILES” folder and named as “USERFILExx.usr.”

#### Overwriting the file

If you select a container which contains a User file, three dots appear in the display (ex., “A.0.0.”). If you do not want to overwrite the file, press the **[-/NO]** button when “n y (no or yes)” appears in the display and select another container. If you want to overwrite the file, press the **[+ /YES]** button when “n y (no or yes)” appears in the display. After “n y” appears in the display again to confirm whether you wish to overwrite the file or not, press the **[+ /YES]** button once more.

#### **!** CAUTION

While the instrument is accessing data (such as during Save, Export, Delete, Load and Format operations) or is mounting the USB storage device (shortly after the connection: until the FILE LOAD LED flash stops), do NOT unplug the USB cable, do NOT remove the media from the device, and do NOT turn the power off to either devices. Doing so may corrupt the data on either or both devices.

### 2. Exit from the file operation mode.

Press the **[FILE]** button several times to exit the file operation mode. (The FILE indicators turn off.)

#### **!** CAUTION

Do not rename User files on a computer. If the file name is changed in this way, the file cannot be loaded to the instrument.

#### NOTE

About Save: See page 35.

#### NOTE

If you move a User file from the “USER FILES” folder using a computer, the file cannot be recognized on the instrument.

# Exporting a Song in SMF format

## TERMINOLOGY

### SMF (Standard MIDI File):

The SMF (Standard MIDI File) format is one of the most common and widely compatible sequence formats used for storing sequence data. There are two variations: Format 0 and Format 1. A large number of MIDI devices are compatible with SMF Format 0, and most commercially available MIDI sequence data is provided in SMF Format 0. The SMF format for sequence files allows you to exchange song data between different sequencers. User songs recorded on the CLP-240 are exported as SMF Format 0.

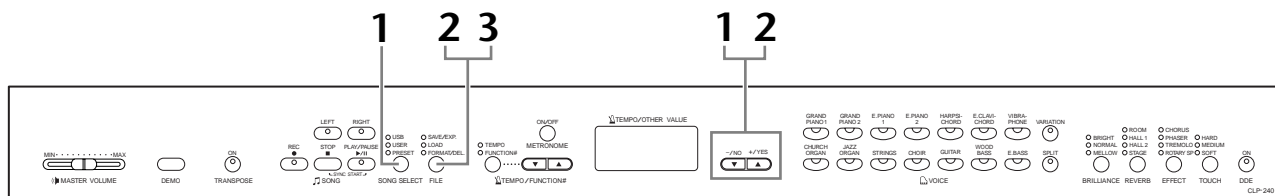

## Procedure

### 1. Select a User song to export.

Select a User song to export by using the [SONG SELECT] and [-/NO][+/YES] buttons.

### 2. Select a song container in the device and export the User song.

After making sure that the USB storage device is connected to the instrument, press the [FILE] button (the “SAVE/EXP.” indicator lights). Then, while holding the [FILE] button, simultaneously press the [-/NO][+/YES] buttons to select a container (S00-S99). After releasing the [FILE] button, “n y” (no/yes) appears in the display. Press the [+ /YES] button to export the songs. The exported song will be converted to SMF format and automatically exported into the “USER FILES” folder and named as “USERSONGxx.mid.”

#### Overwriting the song

If you select a container which contains an SMF song, three dots appear in the display (ex., “S.0.0.”). If you do not want to overwrite the file, press the [-/NO] button when “n y (no or yes)” appears in the display and select another container. If you want to overwrite the song, press the [+ /YES] button. After “n y” appears in the display again to confirm whether you wish to overwrite the file or not, press the [+ /YES] button once more.

### ⚠ CAUTION

While the instrument is accessing data (such as during Save, Export, Delete, Load and Format operations) or is mounting the USB storage device (shortly after the connection: until the FILE LOAD LED flash stops), do NOT unplug the USB cable, do NOT remove the media from the device, and do NOT turn the power off to either devices. Doing so may corrupt the data on either or both devices.

### 3. Exit from the file operation mode.

Press the [FILE] button several times to exit the file operation mode. (The FILE indicators turn off.)

#### NOTE

**About Export:** See page 35.

#### NOTE

If the selected song has no data, the song will not be exported (you cannot select a container for SMF songs — S00-S99). Confirm that the selected song has data by making sure that the indicator of [RIGHT] or [LEFT] is turned on.

#### NOTE

If you move an SMF song from the “USER FILES” folder using a computer, the file type will be changed — from a SMF song (S00-S99) to an External song.

# Deleting Song Files

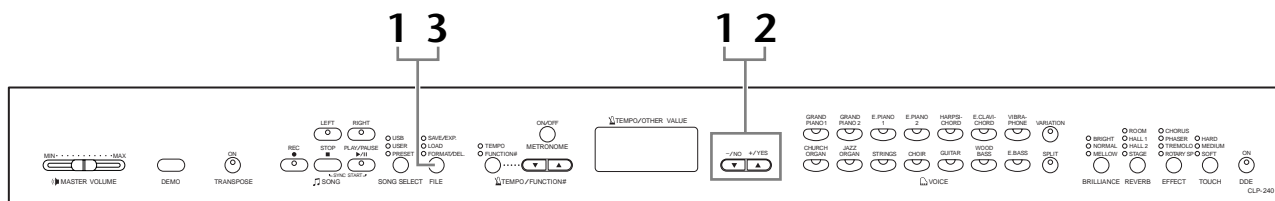

## Procedure

### 1. Select a song file to be deleted.

Press the **[FILE]** button. (The “FORMAT/DEL” indicator lights.) Then, hold the **[FILE]** button, simultaneously press the **[-/NO][+/YES]** buttons to select a file to be deleted. Three types of files will be displayed in order:

- **Axx** ..... User files
- **Sxx**..... SMF songs
- **xxx**..... External songs (commercially available songs or songs which have been edited on a computer)

### 2. Delete the file.

After releasing the **[FILE]** button, “n y (no or yes)” appears in the display. If you want to delete the file, press the **[+/YES]** button. After “n y” appears in the display again to confirm whether you wish to delete the file or not, press the **[+/YES]** button once more.

If you do not want to delete the song, press the **[-/NO]** button.

### ⚠ CAUTION

While the instrument is accessing data (such as during Save, Export, Delete, Load and Format operations) or is mounting the USB storage device (shortly after the connection: until the FILE LOAD LED flash stops), do NOT unplug the USB cable, do NOT remove the media from the device, and do NOT turn the power off to either devices. Doing so may corrupt the data on either or both devices.

### 3. Exit from the file operation mode.

Press the **[FILE]** button several times to exit the file operation mode. (The FILE indicators turn off.)

#### NOTE

Audition the song to be deleted before deleting. Songs cannot be played back after engaging the Delete mode.

#### NOTE

Only files which contain data will be displayed.

#### NOTE

The following types of songs cannot be deleted. If you try to delete the song, “Pro” (Protected) appears in the display.

- Protected songs (extension: Cxx, Exx or SME)
- DOC (Disk Orchestra Collection) songs
- Disklavier Piano Soft songs

#### NOTE

For User files (Axx) and SMF songs (Sxx), the song numbers are fixed and not changed by deleting files. However, the song numbers of External files are not fixed and may be changed by deleting files.

# Formatting the USB Storage Device

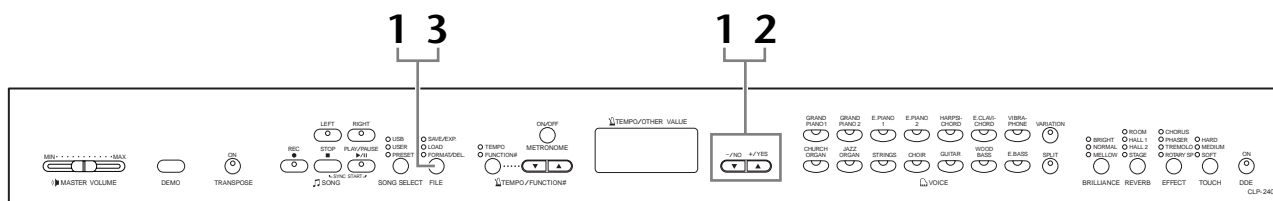

## Procedure

### 1. Engage the format mode.

Press the **[FILE]** button. (The “FORMAT/DEL” indicator lights.) Then, while holding the **[FILE]** button, simultaneously press the **[-/NO]** and **[+ /YES]** buttons. When “For” (Format) appears in the display, release the **[FILE]** button to display “n y” (no/yes).

### 2. Execute the format operation.

After “n y” (no/yes) appears in the display, press the **[+ /YES]** button. After “n y” appears in the display again to confirm whether you wish to format the device or not, press the **[+ /YES]** button once more.

If you do not want to format the device, press the **[-/NO]** button.

### ⚠ CAUTION

While the instrument is accessing data (such as during Save, Export, Delete, Load and Format operations) or is mounting the USB storage device (shortly after the connection: until the FILE LOAD LED flash stops), do NOT unplug the USB cable, do NOT remove the media from the device, and do NOT turn the power off to either devices. Doing so may corrupt the data on either or both devices.

### 3. Exit from the format mode.

Press the **[FILE]** button several times to exit the file operation mode. (The FILE indicators turn off.)

# Playing Back Songs

You can play back songs recorded using the Record function (pages 29–34) or commercially available songs. You can also play the keyboard along with the playback.

- **50 Piano Preset Songs (CLP-240/230) ..... page 15**  
50 Piano Preset Songs in the instrument.
- **User songs in the instrument (CLP-240/230) ..... page 41**  
User songs which you recorded to the instrument by using the record function (page 29).
- **User files in the USB storage device (CLP-240) ..... page 42**  
User files which you saved recorded song data to the USB storage device (page 35).
- **SMF songs in the USB storage device (CLP-240) ..... page 43**  
SMF songs which you exported recorded song data to the USB storage device (page 35).
- **External songs in the USB storage device (CLP-240) ..... page 43**  
Commercially available songs or songs which have been edited on a computer, etc. and stored to a USB storage device. Up to 999 songs can be played back on this instrument (numbers 001-999).
- **External songs in the instrument (CLP-240/230)..... page 41**  
Songs transferred from a computer (including commercially available songs and songs which have been edited on a computer). Songs can be transferred (saved) to the instrument by using the included Musicsoft Downloader software. The songs are saved to an area of the internal memory separate from the area for recorded User songs. Up to 255 songs can be played back on this instrument (numbers 001-255).

## Sequence formats that can be played on the CLP-240/230

### • SMF (Standard MIDI File) Formats 0 and 1

The SMF format is one of the most common and widely compatible sequence formats used for storing sequence data. There are two variations: Format 0 and Format 1. A large number of MIDI devices are compatible with SMF Format 0, and most commercially available MIDI sequence data is provided in SMF Format 0. The SMF format for sequence files allows you to exchange song data between different sequencers. User songs recorded on the CLP-240 are exported as SMF Format 0.

### • ESEQ

This sequence format is compatible with many of Yamaha's MIDI devices, including the Clavinova series instruments. This is a common format used with various Yamaha software. In the ESEQ files, only DOC (Disk Orchestra Collection) files and Disklavier Piano Soft songs can be played back on this instrument.

### NOTE

You cannot select songs in Demo Song mode (page 14) or during file operations (page 35).

### NOTE

When playing back songs containing various voices or parts (such as XG or GM songs), the voices may not sound correct or as intended on the original. You may be able to remedy this and make the playback sound more natural or appropriate by changing the Song Channel Selection setting (page 51) to "1&2," so that only channels 1 and 2 will play back.

### NOTE

If the song cannot be selected or loaded, you may need to change the Character Code setting (page 55).

### NOTE

Song data is not transmitted via the MIDI connections. However, channels 3-16 of DOC songs, Disklavier Piano Soft songs, and non-protected External songs will be transmitted via the MIDI connections depending on the Song Channel Selection setting (page 51).

### NOTE

Appropriate channels in the song will automatically be assigned to **[RIGHT]** and **[LEFT]**. Therefore, **[RIGHT]** may be assigned to a part other than channel 1, or **[LEFT]** to a part other than channel 2.

### NOTE

For the USB storage device, folder directories on this instrument can be recognized up to two levels. However, the level is not displayed and song numbers 001-999 are displayed whichever level the song contains.

### NOTE

If the metronome is being used during playback, the metronome will automatically stop when playback is stopped.

### NOTE

If the REVERB type is changed via the panel controls during playback, both the playback and keyboard reverb effects will be changed.

### NOTE

If the EFFECT type is changed via the panel controls during playback, the playback effect may be switched off in some cases.



# Playing Back User/External Songs on the Instrument

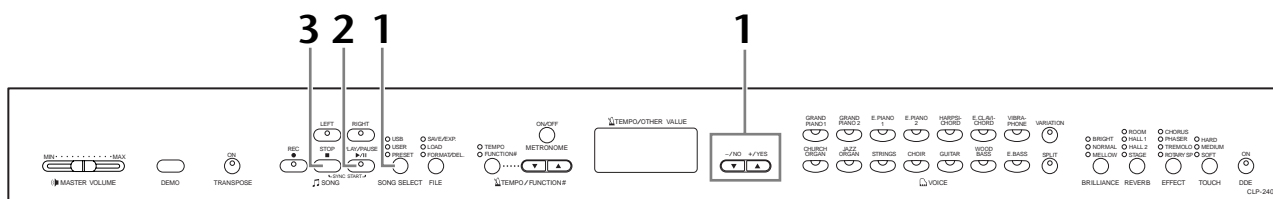

## Procedure

### 1. Select the desired song.

Press the [SONG SELECT] button (the USER indicator lights). Then press the [-/NO] [+ /YES] buttons to select a song. The User songs are displayed as “Uxx\*” and External songs in the instrument are displayed as “xxx\*.”

\*The “U” indication in the User song name means “User.” The letters “xx” represent the song number.

### 2. Start playback.

Press the SONG [PLAY/PAUSE] button.

The current measure number appears on the display during playback.

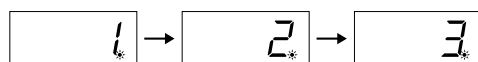

- You can play the keyboard while the Clavinova is playing back a song. You can also play the notes in a voice different from the playback voice by selecting a voice from the panel.

#### Adjust the volume

Use the [MASTER VOLUME] slider to adjust the volume.

#### Adjust the tempo

You can use the [TEMPO/FUNCTION# ▼, ▲] buttons to adjust the playback tempo as required before or during playback. The default tempo (the song’s original tempo) is set when you press the [▼] and [▲] buttons simultaneously.

### 3. Stop playback.

When playback is complete, the Clavinova automatically stops and locates the top of the song. To stop playback in the middle of a song, press the SONG [STOP] button. You can also pause playback by pressing the SONG [PLAY/PAUSE] button.

#### NOTE

User song playback cannot be started when the recorder contains no data.

#### NOTE

You can also enjoy playing duets with yourself by recording one part of a duet or a song for two pianos, then playing the other part while the recorded part plays back.

#### NOTE

If you have External songs in the instrument, you can use the repeat function.

**ALL:** Play all External songs in sequence.

**rnd:** Play all External songs continuously in random order.

# Playing Back User Files from a USB Storage Device (CLP-240)

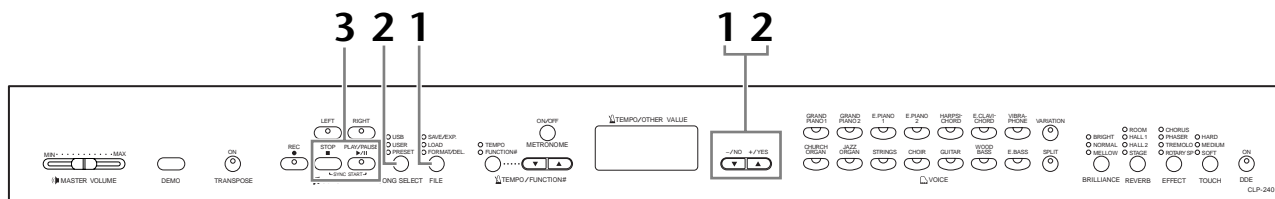

## Procedure

### 1. Load a User song file from the USB storage device.

After making sure that the USB storage device is connected to the instrument, press the **[FILE]** button (the LOAD indicator lights). Then, while holding the **[FILE]** button, press the **[-/NO]** **[+ /YES]** buttons to select a User song file (Axx\*). After releasing the **[FILE]** button, “n y (no or yes)” indication appears in the display, press the **[+ /YES]** button to start loading. When loading is started, dashes appear in the display in succession to indicate that the data is being loaded to the instrument. To cancel the operation, press the **[-/NO]** button.

\* The “A” indication means “All”—all three songs in the instrument are saved as a User song file. The letters “xx” represent the file number.

#### ⚠ CAUTION

When you load a User song file, three User songs in the instrument will be overwritten. If you do not want to overwrite them, save them to the USB storage device before loading.

#### ⚠ CAUTION

While the instrument is accessing data (such as during Save, Export, Delete, Load and Format operations) or is mounting the USB storage device (shortly after the connection: until the FILE LOAD LED flash stops), do NOT unplug the USB cable, do NOT remove the media from the device, and do NOT turn the power off to either devices. Doing so may corrupt the data on either or both devices.

#### ⚠ CAUTION

Do not turn off the power of the instrument when dashes appear in the display in succession. Doing so may delete all song data in the instrument, including external songs (page 40).

### 2. Select the desired song.

Press the **[FILE]** button twice to exit the file mode. Then, press the **[SONG SELECT]** button (the USER indicator lights), and press the **[-/NO]** **[+ /YES]** buttons to select a User song.

### 3. Start and stop playback.

Same as steps 2 and 3 in “Playing Back User/External Songs on the Instrument” on page 41.

#### NOTE

Files which do not contain data will not be displayed.

#### NOTE

If you rename the User song file from a computer, the song cannot be loaded.

# Playing Back SMF/External songs from a USB storage device (CLP-240)

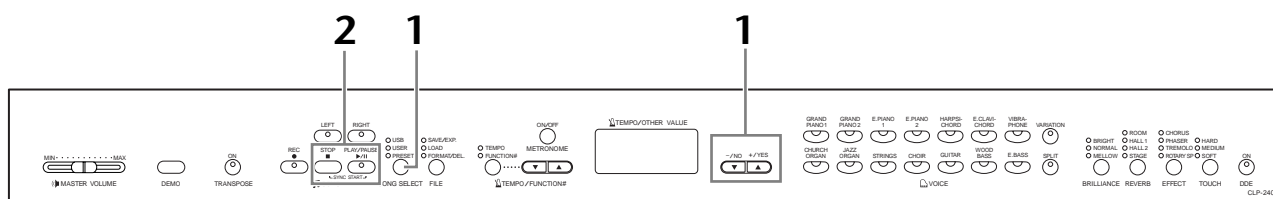

## Procedure

### 1. Select the desired song.

After making sure that the USB storage device is connected to the instrument, press the [SONG SELECT] button (the USB indicator lights). Then, press the [-/NO] [+ /YES] buttons to select a song. The SMF songs are displayed as “Sxx\*” and External songs are displayed as “xxx\*.”

\* The “S” indication in the SMF song name means “SMF.” The letters “xx” represent the song number.

#### Repeating songs in the USB Storage device.

**Select “ALL”:** Play all SMF/External songs in the USB storage device in sequence.

**Select “rnd”:** Play all SMF/External songs in the USB storage device continuously in random order.

### 2. Start and stop playback.

Same as step 2 and 3 in “Playing Back User/External Songs on the Instrument” on page 41.

## Useful Playback Functions

### Turning part playback on and off

When you select a song on the Clavinova, the indicators for parts that contain data (one of [RIGHT] [LEFT] or both) are lit in green. While the Clavinova is playing or stopped, pressing these part buttons turns off the indicators, and the data on those parts is not played. Pressing the part buttons toggles part playback on and off.

### Starting playback automatically when you start playing the keyboard (Sync Start)

You can start playback as soon as you start playing the keyboard. This is called the “Sync Start” function.

To engage the Sync Start function, press the SONG [PLAY/PAUSE] button while holding down the SONG [STOP] button. The SONG [PLAY/PAUSE] lamp will flash at the current tempo.

(Repeat the previous operation to disengage the Sync Start function.)

Playback will then start as soon as you begin playing on the keyboard.

This function is useful when you wish to match the timing of the beginning of the playback sound and the start of your own performance.

### Assigning the PLAY/PAUSE function to the left pedal

The left pedal can also be assigned to song play/pause operation via the “Pedal Play/Pause” (page 51). This is convenient for starting playback of the song anytime after you have started playing.

#### NOTE

Parts can be turned on or off before or during playback.

#### NOTE

You can adjust the volume of a part of a song for which playback is turned off (pages 17, 52).

#### TERMINOLOGY

##### Sync:

Synchronized; occurring at the same time

# Detailed Settings – [FUNCTION]

You can set various parameters to make the best use of Clavinova functions, such as fine tuning the pitch or selecting a scale, etc.

The following parameters are available.

The CLP-240 has nine main functions, and the CLP-230 has eight main functions.

Some of these main functions consist of a set of sub-modes.

## Parameter List

Function	Sub-Mode	CLP-240	CLP-230	Reference page
<b>Fine tuning of the pitch</b>	—	F1	F1	47
<b>Selecting a scale</b>	Scale	F2.1	F2.1	48
	Base Note	F2.2	F2.2	48
<b>Dual mode functions</b>	Dual Balance	F3.1	F3.1	49
	Dual Detune	F3.2	F3.2	49
	Voice 1 Octave Shift	F3.3	F3.3	49
	Voice 2 Octave Shift	F3.4	F3.4	49
	Voice 1 Effect Depth	F3.5	F3.5	49
	Voice 2 Effect Depth	F3.6	F3.6	49
	Reset	F3.7	F3.7	49
<b>Split mode functions</b>	Split Point	F4.1	—	50
	Split Balance	F4.2	—	50
	Right Voice Octave Shift	F4.3	—	50
	Left Voice Octave Shift	F4.4	—	50
	Right Voice Effect Depth	F4.5	—	50
	Left Voice Effect Depth	F4.6	—	50
	Damper Pedal Range	F4.7	—	50
	Reset	F4.8	—	50
<b>Other Functions</b>	Left Pedal Mode	F5.1	F4.1	51
	Soft Pedal Effect Depth	F5.2	F4.2	51
	Sustain Sample Depth	F5.3	—	51
	Keyoff Sample Volume	F5.4	—	51
	Song Channel Selection	F5.5	F4.3	51
<b>Metronome volume</b>	—	F6	F5	52
<b>Song Part Cancel Volume</b>	—	F7	F6	52
<b>MIDI Functions</b>	MIDI Transmit Channel Selection	F8.1	F7.1	52
	MIDI Receive Channel Selection	F8.2	F7.2	53
	Local Control ON/OFF	F8.3	F7.3	53
	Program Change ON/OFF	F8.4	F7.4	53
	Control Change ON/OFF	F8.5	F7.5	53
	Panel/Status Transmit	F8.6	F7.6	54
	Initial Setup Send	F8.7	F7.7	54
<b>Backup Functions</b>	Voice	F9.1	F8.1	55
	MIDI	F9.2	F8.2	55
	Tuning	F9.3	F8.3	55
	Others	F9.4	F8.4	55
<b>Character Code</b>	—	F9.5	F8.5	55

# Basic Procedure in Function Mode

Follow the steps below to use the functions.

(If you become lost while using a function, return to this page and read the basic procedure.)

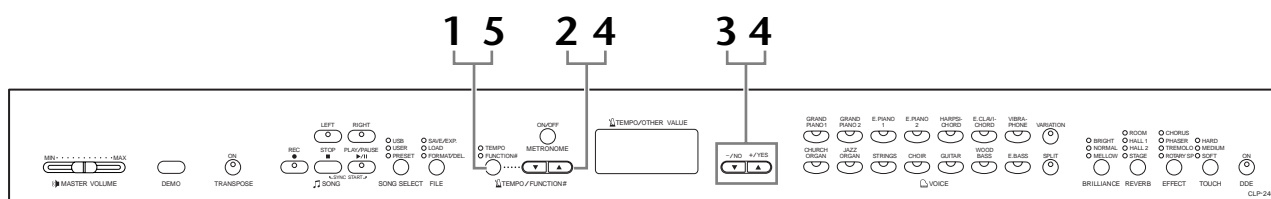

## Procedure

### 1. Engage the Function mode.

Press the [TEMPO/FUNCTION#] button so that its [FUNCTION#] indicator lights.

[F \* \*] will appear on the display. (The indication of “\* \*” varies depending on the status of the unit and usage.)

### 2. Select a function.

Use the [TEMPO/FUNCTION# ▼, ▲] buttons to select the desired function from F1–F9 (CLP-240) / F1–F8 (CLP-230).

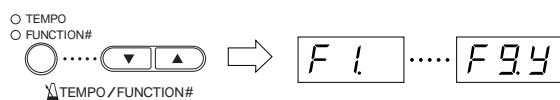

### 3. Use the [-/NO] [+ /YES] buttons.

If the function does not include sub-modes, start setting the parameters.

If the function includes sub-modes, press the [+ /YES] button once to enter the respective sub-mode.

### 4. Operate the desired function using the following two buttons.

- 1 [TEMPO/FUNCTION# ▼, ▲]  
Selects the desired function/sub-mode.
- 2 [-/NO] or [+ /YES]  
After you select the desired function or sub-mode, set the ON/OFF, select the type, or change the value, accordingly.  
Depending on the setting, the default setting (which is used when you first turn on the power to the Clavinova) is recalled by pressing the [-/NO] and [+ /YES] buttons simultaneously.

#### NOTE

Functions cannot be selected during Demo/Song Select/ file operation (CLP-240) mode or when the user song recorder is in operation.

#### NOTE

To cancel the function in Step 2, 3, or 4, press the [TEMPO/FUNCTION# ▼, ▲] button any time to exit Function mode.

#### NOTE

After you select the function, the current setting will be displayed when the [-/NO] or [+ /YES] button is pressed for the first time.

### Operation Example 1 (F1. Fine tuning of the pitch)

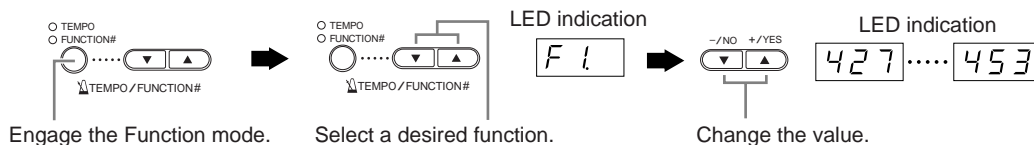

### Operation Example 2 (F3.1 “Dual Balance”)

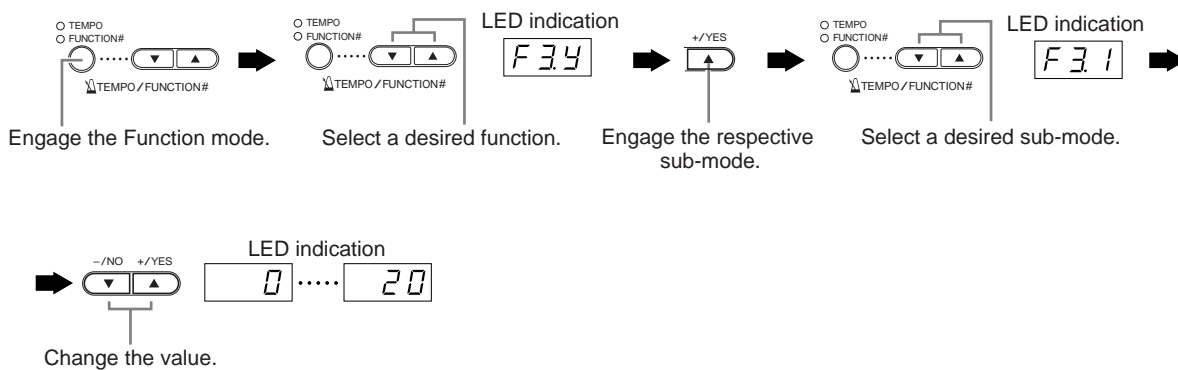

ENGLISH

## 5. After using the function, exit the function mode.

To exit the Function mode, press the [TEMPO/FUNCTION#] button so that its [TEMPO] indicator lights.

# About Each Function

## F1. Fine Tuning of the Pitch

You can fine tune the pitch of the entire instrument. This function is useful when you play the Clavinova along with other instruments or CD music.

1. Engage the Function mode and select **[F1]**.
2. Use the **[-/NO]** and **[+/YES]** buttons to lower or raise the pitch of the A3 key in approximately 0.2 Hz increments.

**[427].....[440].....[453]**

Tenths of a hertz are indicated on the LED display by the appearance and position of one or two dots, as in the following example:

Display	Value
<b>[440]</b>	440.0
<b>[440.]</b>	440.2
<b>[440.0]</b>	440.4
<b>[440.00]</b>	440.6
<b>[440.000]</b>	440.8

**Setting range:**  
427.0–453.0 (Hz)

**Normal setting:**  
440.0 (Hz)

### TERMINOLOGY

#### Hz (Hertz):

This unit of measurement refers to the frequency of a sound and represents the number of times a sound wave vibrates in a second.

### NOTE

**You can also use the keyboard to set the pitch (in any mode other than Function mode).**

**To tune up (in about 0.2Hz steps):** Hold the A-1 and B-1 keys (two white keys at the left end) simultaneously and press any key between C3 and B3.

**To tune down (in about 0.2Hz steps):** Hold the A-1 and A<sup>#</sup>-1 keys (a white and a black key at the left end) simultaneously and press any key between C3 and B3.

**To restore standard pitch:** Hold the A-1, A<sup>#</sup>-1 and B-1 (two white keys and one black key at the left end) simultaneously and press any key between C3 and B3.

- Each key has a note name; for example, the lowest (farthest left) key on the keyboard corresponds to A-1, and the highest (farthest right) key to C7.

During the procedure described above, the display indicates a value in Hz <**[427]**...**[453]**>. After the procedure, the display returns to the previous indication.

### NOTE

**You can also tune in about 1Hz steps (in any mode other than Function mode).**

**To tune down or up, respectively, in approximately 1 Hz increments:** Hold the A-1 and A<sup>#</sup>-1 keys (a white and a black key at the left end) or A-1 and B-1 keys (two white keys at the left end) simultaneously and press the **[-/NO]** or **[+/YES]** button.

**To restore standard pitch:** Hold the A-1 and A<sup>#</sup>-1 keys (a white and a black key at the left end) or A-1 and B-1 keys (two white keys at the left end) simultaneously and press the **[-/NO]** **[+/YES]** buttons simultaneously.

During the procedure described above, the display indicates a value in Hz <**[427]**...**[453]**>. After the procedure, the display returns to the previous indication.

## F2. Selecting a Scale

You can select various scales.

Equal Temperament is the most common contemporary piano tuning scale. However, history has known numerous other scales, many of which serve as the basis for certain genres of music. You can experience these tunings with the Clavinova.

### Equal Temperament

One octave is divided into twelve equal intervals. Currently the most popular piano tuning scale.

### PureMajor/PureMinor

Based on natural overtones, three major chords using these scales produce a beautiful, pure sound.

### Pythagorean

This scale, designed by Pythagoras, a Greek philosopher, is based on the interval of a perfect 5th.

The 3rd produces swells, but the 4th and 5th are beautiful and suitable for some leads.

### MeanTone

This scale is an improvement of the Pythagorean in that the swell of the 3rd has been eliminated. The scale became popular during the late 16th century through the late 18th century, and was used by Handel.

### Werckmeister/Kirnberger

These scales combine Mean Tone and Pythagorean in different ways. With these scales, modulation changes the impression and feel of the songs. They were often used in the era of Bach and Beethoven. They are often used today to reproduce the music of that era on harpsichords.

1. Engage the Function mode and select **[F2.4]**.

2. Press the **[+ / YES]** button to engage the scale function's sub-mode, then use the **[TEMPO / FUNCTION# ▼, ▲]** buttons to select the desired sub-mode.

Press the **[- / NO]** and **[+ / YES]** buttons to select the number of the desired tuning.

### Sub-mode

#### **[F2.1]** Scale

**Setting range:**

- 1: Equal Temperament
- 2: Pure Major
- 3: Pure Minor
- 4: Pythagorean
- 5: Mean Tone
- 6: Werckmeister
- 7: Kirnberger

**Normal setting:** 1: Equal Temperament

#### **[F2.2]** Base Note

If you select a scale other than Equal Temperament, you need to specify the root. (You can specify the root note with Equal Temperament selected, but it is not effective. The base note setting is effective for tunings other than the Equal Temperament tuning.)

**Setting range:** C, C<sup>#</sup>, D, E<sup>b</sup>, E, F, F<sup>#</sup>, G, A<sup>b</sup>, A, B<sup>b</sup>, B

**Normal setting:** C

- Root indication example

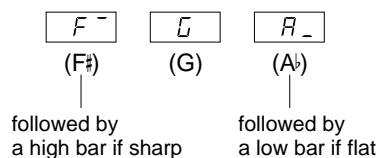



## F3. Dual Mode Functions

You can set various parameters for Dual mode to optimize the settings for the songs you play, such as adjusting the volume balance between two voices.

Dual mode function settings are set individually for each voice combination.

1. Select the voices in Dual mode, then engage the Function mode and select **[F34]**.
2. Press the [+ / YES] button to engage the Dual mode function's sub-mode, then use the [TEMPO / FUNCTION# ▼, ▲] buttons to select the desired sub-mode. Press the [- / NO] [+ / YES] button to assign values.

### NOTE

If Dual mode is not engaged, **[F3-]** will appear instead of **[F34]** and you will be unable to select Dual mode functions. You can switch from Function mode to Dual mode.

### Sub-mode

#### **[F31]** Dual Balance

**Setting range:** 0 – 20 (A setting of “10” produces an equal balance between the two Dual mode voices. Settings below “10” increase the volume of Voice 2 in relation to Voice 1, and settings above “10” increase the volume of Voice 1 in relation to Voice 2.)

**Normal setting:** Different for each voice combination.

You can set one voice as the main voice, and another voice as a softer, mixed voice.

#### **[F32]** Dual Detune

**Setting range:** -10 – 0 – 10 (With positive values, the pitch of Voice 1 is raised and the pitch of Voice 2 is lowered. With negative values, the pitch of Voice 1 is lowered and the pitch of Voice 2 is raised.)

### NOTE

The available setting range is wider in the lower range ( $\pm 60$  cents for A-1), and narrower in the higher range ( $\pm 5$  cents for C7). (100 cents equal one semitone.)

**Normal setting:** Different for each voice combination.

Detune Voice 1 and Voice 2 for Dual mode to create a thicker sound.

#### **[F33]** Voice 1 Octave Shift

#### **[F34]** Voice 2 Octave Shift

**Setting range:** -1, 0, 1

**Normal setting:** Different for each voice combination.

You can shift the pitch up and down in octave steps for Voice 1 and Voice 2 independently. Depending on which voices you combine in Dual mode, the combination may sound better if one of the voices is shifted up or down an octave.

#### **[F35]** Voice 1 Effect Depth

#### **[F36]** Voice 2 Effect Depth

**Setting range:** 0 – 20

**Normal setting:** Different for each voice combination.

These functions make it possible to individually set the depth of the effect for Voices 1 and 2 for Dual mode. (The effect depth settings cannot be changed unless the [EFFECT] is ON. Function mode must be exited before the [EFFECT] can be turned ON.)

- “Voice 1” and “Voice 2” are explained on page 25.

#### **[F37]** Reset

This function resets all Dual mode functions to their default values. Press the [+ / YES] button to reset the values.

### NOTE

#### SHORTCUT:

You can jump directly to the Dual mode functions **[F3\*]** by pressing the [TEMPO / FUNCTION#] button while holding the two Dual mode voice buttons.

To exit Function mode, you still need to press the [TEMPO / FUNCTION#] button so that the TEMPO indicator lights up.

## F4. (CLP-240) Split Mode Functions

This menu enables you to make various detailed settings for Split mode.

By changing the split point or other setting, you can optimize the settings for the songs you play.

1. Select the voices in Split mode, then engage the Function mode and select **[F49]**.
2. Press the **[+/YES]** button to engage the Split mode function's sub-mode, then use the **[TEMPO/FUNCTION# ▼, ▲]** buttons to select the desired sub-mode. Press the **[-/NO] [+ /YES]** button to assign values.

### NOTE

If Split mode is not engaged, **[F4-]** will appear instead of **[F49]** and you will be unable to select Split mode functions. Also note that you must exit Function mode before you can engage Split mode.

### Sub-mode

#### **[F41]** Split Point

**Setting range:** The entire keyboard

**Normal setting:** F#2

Set the point on the keyboard that separates the right and left-hand sections (split point). The pressed key is included in the left-hand range.

- Instead of pressing the **[-/NO] [+ /YES]** buttons, you can engage the split point by pressing the appropriate key on the keyboard.
- If Function mode is not engaged, you can change the split point to any other key by pressing the key while holding the **[SPLIT]** button (page 26).
- An example of a key name indication for a split point

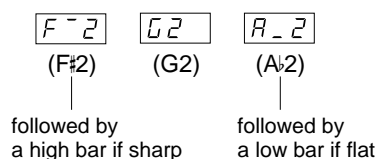

#### **[F42]** Split Balance

**Setting range:** 0 – 20 (A setting of “10” produces an equal balance between the two Split mode voices. Settings below “10” increase the volume of the left voice in relation to the right voice, and settings above “10” increase the volume of the right voice in relation to the left voice.)

**Normal setting:** Different for each voice combination.

The volume level of the two voices combined in Split mode can be adjusted as required. You can make this setting for each combination of voices individually.

#### **[F43]** Right Voice Octave Shift

#### **[F44]** Left Voice Octave Shift

**Setting range:** -1, 0, 1

**Normal setting:** Different for each voice combination  
You can shift the pitch up and down in octave steps for the Right Voice and Left Voice independently. Make a setting depending on the note range of the songs you play. You can make this setting for each combination of voices individually.

#### **[F45]** Right Voice Effect Depth

#### **[F46]** Left Voice Effect Depth

**Setting range:** 0 – 20

**Normal setting:** Different for each voice combination  
These functions make it possible to individually set the depth of the effect for the left and right Split mode voices.

The effect depth settings cannot be changed unless the **[EFFECT]** is ON. You must exit Function mode before you can turn on an **[EFFECT]**.

You can make this setting for each combination of voices individually.

#### **[F47]** Damper Pedal Range

**Setting range:** ALL (for both voices)  
1 (for the right Voice)  
2 (for the left Voice)

**Normal setting:** ALL

The Damper Pedal Range function determines whether the damper pedal affects the right voice, the left voice, or both the left and right voices in Split mode.

#### **[F48]** Reset

This function resets all Split mode functions to their default values. Press the **[+/YES]** button to reset the values.

### NOTE

#### SHORTCUT:

You can jump directly to Split mode functions **[F4\*]** by pressing the **[TEMPO/FUNCTION#]** button while holding the **[SPLIT]** button.

To exit Function mode, you still need to press the **[TEMPO/FUNCTION#]** button so that the TEMPO indicator lights up.

## F5. (CLP-240) / F4. (CLP-230) Other Functions

This section provides a variety of other functions, including letting you assign the operation of the left pedal to one of several modes, and allowing you to select specific song channels for playback.

1. Engage the Function mode and select **F54** (CLP-240)/**F44** (CLP-230).
2. Press the [+ / YES] button to engage the other functions' sub-mode, then use the [TEMPO / FUNCTION# ▼, ▲] buttons to select the desired sub-mode.  
Press the [- / NO] or [+ / YES] button to select the desired pedal function or assign the values.

### Sub-mode

**F51** (CLP-240) / **F41** (CLP-230)

#### Left Pedal Mode

##### Setting range:

1. Soft Pedal  
The soft pedal reduces the volume and slightly changes the timbre of notes played while the pedal is pressed. The soft pedal will not affect notes that are already playing.
2. Song Play/Pause  
This mode allows you to start or pause song playback. In this mode, the Left Pedal functions in the same manner as the **SONG [PLAY/PAUSE]** button on the panel.
3. Variation (CLP-240)  
This mode enables you to switch the Voice's variation on or off. In this mode, the left pedal functions in the same manner as the **[VARIATION]** button on the panel.

**Normal setting:** 1 (Soft Pedal)

**F52** (CLP-240) / **F42** (CLP-230)

#### Soft Pedal Effect Depth

**Setting range:** 1 – 5

**Normal setting:** 3

This function sets the depth of the soft pedal effect.

**F53** (CLP-240)

#### Sustain Sample Depth

**Setting range:** 0 – 20

**Normal setting:** 12

The **GRAND PIANO 1** voice features special “Sustain Samples” that recreate the unique resonance of an acoustic grand piano’s soundboard and strings when the damper pedal is pressed. This function lets you adjust the depth of this effect.

**F54** (CLP-240)

#### Keyoff Sample Volume

**Setting range:** 0 – 20

**Normal setting:** 10

You can adjust the volume of the keyoff sound (the subtle sound produced when the keys are released) for voices **[GRAND PIANO1]**, **[HARPSICHORD]**, **[E.CLAVICHORD]** (including their variations).

**F55** (CLP-240) / **F43** (CLP-230)

#### Song Channel Selection

**Setting range:** ALL, 1&2

**Normal setting:** ALL

The setting here only affects DOC (Disk Orchestra Collection) songs, Disklavier Piano Soft songs, and non-protected External songs. You can specify which song channels will play back on this instrument. When “ALL” is selected, channels 1-16 will be played back. When “1&2” is selected, only channels 1 and 2 will be played back, while channels 3-16 will be transmitted via MIDI.

## F6. (CLP-240) / F5. (CLP-230) Metronome Volume

You can change the volume of the metronome sound.

Use this function to adjust the metronome volume.

1. Engage the Function mode and select **F6** (CLP-240)/**F5** (CLP-230).
2. Use the **[-/NO]** and **[+/YES]** buttons to set the metronome volume as required.

**Setting range:** 1 – 20

**Normal setting:** 10

### NOTE

#### SHORTCUT:

You can jump directly to the metronome functions **F6** (CLP-240)/**F5** (CLP-230) by pressing the **[TEMPO/FUNCTION#]** button while holding the **METRONOME [ON/OFF]** button.

To exit the Function mode, you still need to press the **[TEMPO/FUNCTION#]** button so that the TEMPO indicator lights up.

## F7. (CLP-240) / F6. (CLP-230) Song Part Cancel Volume

This function sets the volume at which a “canceled” part is played during song playback. Adjust the part volume to a comfortable level and use the “canceled” part as a guide with which to play along.

1. Engage the Function mode and select **F7** (CLP-240)/**F6** (CLP-230).
2. Use the **[-/NO]** and **[+/YES]** buttons to set the volume as required.

**Setting range:** 0 – 20

**Normal setting:** 5

### NOTE

This function cannot be used for Demo songs.

## F8. (CLP-240) / F7. (CLP-230) MIDI Functions

You can make detailed adjustments to MIDI settings.

For more information about MIDI, see the “About MIDI” section (page 57).

All MIDI settings described below will affect the MIDI signal in and out of the **USB [TO HOST]** connector.

1. Engage the Function mode and select **F8** (CLP-240)/**F7** (CLP-230).
2. Press the **[+/YES]** button to engage the MIDI function’s sub-mode, then use the **[TEMPO/FUNCTION# ▼, ▲]** buttons to select the desired sub-mode.  
Press the **[-/NO]** or **[+/YES]** button to set a selected parameter.

### Sub-mode

**F8 1** (CLP-240)/**F7 1** (CLP-230)

#### MIDI Transmit Channel Selection

In any MIDI control setup, the MIDI channels of the transmitting and receiving equipment must be matched for proper data transfer.

This parameter enables you to specify the channel on which the Clavinova transmits MIDI data.

**Setting range:** 1 – 16, OFF (not transmitted)

**Normal setting:** 1

### NOTE

In Dual mode, Voice 1 data is transmitted on its specified channel. In Split mode (CLP-240), right voice data is transmitted on its specified channel. In Dual mode, Voice 2 data is transmitted on the next greater channel number relative to the specified channel. In Split mode (CLP-240), left voice data is transmitted on the next greater channel number relative to the specified channel. In either mode, no data is transmitted if the transmit channel is set to “OFF.”

### NOTE

Song data is not transmitted via the MIDI connections. However, channels 3-16 of DOC songs, Disklavier Piano Soft songs, and non-protected External songs will be transmitted via the MIDI connections depending on the Song Channel Selection setting (page 51).

**F82** (CLP-240)/**F72** (CLP-230)**MIDI Receive Channel Selection**

In any MIDI control setup, the MIDI channels of the transmitting and receiving equipment must be matched for proper data transfer. This parameter enables you to specify the channel on which the Clavinova receives MIDI data.

**Setting range:** ALL, 1&2, 1 – 16**Normal setting:** ALL**NOTE****ALL:**

“Multi-timbre” Receive mode. This allows simultaneous reception of different parts on all 16 MIDI channels, enabling the Clavinova to play multi-channel song data received from a music computer or sequencer.

**1&2:**

“1&2” Receive mode. This allows simultaneous reception on channels 1 and 2 only, enabling the Clavinova to play 1 and 2 channel song data received from a music computer or sequencer.

**NOTE**

Program change and other like channel messages received will not affect the CLP-240/230’s panel settings or the notes you play on the keyboard.

**NOTE**

No MIDI reception occurs when Demo mode is engaged or during file operations (CLP-240).

**F83** (CLP-240)/**F73** (CLP-230)**Local Control ON/OFF**

“Local Control” refers to the fact that, normally, the CLP-240/230 keyboard controls its internal tone generator, allowing the internal voices to be played directly from the keyboard. This situation is “Local Control On,” since the internal tone generator is controlled locally by its own keyboard.

Local control can be turned OFF, however, so that the CLP-240/230 keyboard does not play the internal voices, but the appropriate MIDI information is still transmitted via the MIDI OUT terminal when notes are played on the keyboard. At the same time, the internal tone generator responds to MIDI information received via the MIDI IN terminal.

**Setting range:** ON/OFF**Normal setting:** ON**F84** (CLP-240)/**F74** (CLP-230)**Program Change ON/OFF**

Normally the CLP-240/230 will respond to MIDI program change numbers received from an external keyboard or other MIDI device, causing the correspondingly-numbered voice to be selected on the corresponding channel (the keyboard voice does not change). The CLP-240/230 will normally also send a MIDI program change number whenever one of its voices is selected, causing the correspondingly-numbered voice or program to be selected on the external MIDI device if the device is set up to receive and respond to MIDI program change numbers.

This function makes it possible to cancel program change number reception and transmission so that voices can be selected on the CLP-240/230 without affecting the external MIDI device.

**NOTE**

For information on program change numbers for each of the CLP-240/230’s voices, refer to page 81 in the MIDI Data Format section.

**Setting range:** ON/OFF**Normal setting:** ON**F85** (CLP-240)/**F75** (CLP-230)**Control Change ON/OFF**

Normally the CLP-240/230 will respond to MIDI control change data received from an external MIDI device or keyboard, causing the voice on the corresponding channel to be affected by pedal and other “control” settings received from the controlling device (the keyboard voice is not affected).

The CLP-240/230 also transmits MIDI control change information when the pedal or other appropriate controls are operated.

This function makes it possible to cancel control change data reception and transmission so that, for example, the CLP-240/230’s pedal and other controls can be operated without affecting an external MIDI device.

**NOTE**

For information on control changes that can be used with the CLP-240/230, refer to the MIDI Data Format on page 80.

**Setting range:** ON/OFF**Normal setting:** ON

**F B 6** (CLP-240)/**F 7 6** (CLP-230)**Panel/Status Transmit**

This function causes all the current CLP-240/230 panel settings (selected voice, etc.) to be transmitted via the MIDI OUT terminal.

**TERMINOLOGY****Setup Data:**

Data that contains a set of panel settings for the Clavinova.

**Procedure**

1. Set up the panel controls as desired.
2. Connect the Clavinova to a sequencer via MIDI, and set up the sequencer so it can receive the setup data.
3. Engage the Function mode and select **F B 6** (CLP-240)/**F 7 6** (CLP-230).
4. Press the **[+/YES]** button to transmit the panel/status data.

**E n d** will appear on the LED display when the data has been successfully transmitted.

**NOTE**

See page 81 for a list of the "Panel Data Contents" transmitted by this function.

**NOTE****Receiving the transmitted data:**

1. Connect the Clavinova via MIDI to the device to which the setup data was transmitted previously.
  2. Start sending the setup data from the device.
- The Clavinova automatically receives the setup data, which will be reflected in the panel settings.
- (For the data to be accepted, the Clavinova that receives the setup data should be the same model as the one that transmitted the setup data to the sequencer.)

**NOTE**

For more information on transmitting and receiving setup data via MIDI, refer to the owner's manual for the connected MIDI device.

**F B 7** (CLP-240)/**F 7 7** (CLP-230)**Initial Setup Send**

This function lets you send the data of the panel settings to a computer. By transmitting the panel settings and recording them on the MIDI sequence recorder prior to the actual performance data, the instrument will be automatically restored to the same settings when the performance is played back. You can also use this function to change the settings of a connected tone generator to the same settings as the instrument.

**Procedure**

1. Set up the panel controls as desired.
2. Connect the Clavinova to a sequencer via MIDI, and set up the sequencer so it can receive the setup data.
3. Engage the Function mode and select **F B 7** (CLP-240)/**F 7 7** (CLP-230).
4. Press the **[+/YES]** button to transmit the panel/status data.

**E n d** will appear on the LED display when the data has been successfully transmitted.

The following data can be sent.

- Voice selection
- [REVERB] type
- [REVERB] depth
- [EFFECT] type
- [EFFECT] depth
- Split point
- Tuning (F1)
- Dual detune (F3.2)



## F9. (CLP-240) / F8. (CLP-230) Backup Functions

### TERMINOLOGY

#### Backup:

You can back up some settings, such as voice selection and reverb type, so that they will not be lost when you turn off the power to the Clavinova.

If the backup function is turned on, the settings at power off are effective. If the backup function is turned off, the settings in memory are erased when you turn off the power. In this case, when you turn on the power to the unit, the default settings (the initial settings) will be used. (The factory setting default list is found on page 78.)

However, the backup settings themselves, the contents of the user song recorder memory, and character code setting are always backed up.

You can turn the backup function on or off for each function group (each of the following sub-mode functions).

1. Engage the Function mode and select **F94** (CLP-240)/**F84** (CLP-230).
2. Press the **[+ / YES]** button to engage the backup function's sub-mode, then use the **[TEMPO / FUNCTION# ▼, ▲]** buttons to select the desired sub-mode.  
Press the **[- / NO]** or **[+ / YES]** button to turn the backup function on or off.

### Sub-mode

**F91** (CLP-240)/**F81** (CLP-230) **Voice**

**F92** (CLP-240)/**F82** (CLP-230) **MIDI**

**F93** (CLP-240)/**F83** (CLP-230) **Tuning**

**F94** (CLP-240)/**F84** (CLP-230) **Others**

**Setting range:** ON/OFF

**Normal setting:** Voice: OFF  
MIDI – Others: ON

### Description of sub-modes

**F91** (CLP-240)/**F81** (CLP-230) **Voice**

- Voice (Keyboard, Dual, and Split <CLP-240>)
- Dual (ON/OFF, Voice, and Dual Functions for each voice combination)
- Split (CLP-240) (ON/OFF, Voice, and Split Functions for each voice combination)

- Reverb (ON/OFF, Type, and Depth for each voice)
- Effect (ON/OFF, Type, and Depth for each voice)
- Variation (CLP-240) (for each voice)
- Touch Sensitivity (including the FIXED volume)
- Metronome (Beat, Volume <**F5**> (CLP-240)/**F5**> (CLP-230) settings)
- Song Part Cancel Volume (**F7** <CLP-240>/**F5** <CLP-230> settings)

**F92** (CLP-240)/**F82** (CLP-230) **MIDI**

The MIDI functions (**F8\*** <CLP-240>/**F7\*** <CLP-230> settings)

(expect for the **F87** **F88** <CLP-240>/**F77** **F78** <CLP-230>)

**F93** (CLP-240)/**F83** (CLP-230) **Tuning**

- Transpose
- Tuning (**F1** settings)
- Scale (including base note) (**F2\*** settings)

**F94** (CLP-240)/**F84** (CLP-230) **Others**

- Other functions (**F5\*** <CLP-240>/**F4\*** <CLP-230> settings)
- BRILLIANCE setting
- DDE settings (CLP-240) (ON/OFF, depth)

### Factory Preset Recall

All Dual mode, Split mode, reverb, effect, touch sensitivity, tuning settings, and the settings affected by the Backup Functions can be restored to their original factory preset values by holding the C7 key (right-most key on the keyboard) while turning the **[POWER]** switch ON. This also erases all user song recorder data, and sets all backup on/off settings (F9 <CLP-240>/F8 <CLP-230>) to the normal settings. (The factory setting list is found on page 78.)

### ⚠ CAUTION

Do not turn off the power of the instrument when "CLr" appears in the display. Doing so may delete all song data in the instrument, including external songs (page 40).

## F9.5 (CLP-240) / F8.5 (CLP-230) Character Code

If the song cannot be loaded, you may need to change the character code setting.

**Setting range:** En (English)/JA (Japanese)

**Normal setting:** En

# Connections

## Connectors

### ⚠ CAUTION

Before connecting the Clavinova to other electronic components, turn off the power to all the components. Before turning the power on or off to all components, set all volume levels to minimum (0). Otherwise, electrical shock or damage to the components may result.

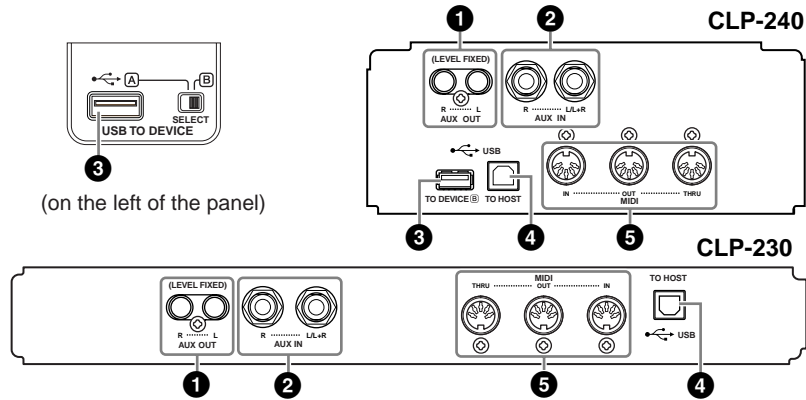

### 1 AUX OUT [R] [L] Pin jacks (LEVEL FIXED)

You can connect these jacks to a stereo system to amplify the Clavinova or to a cassette tape recorder to record your performance. Refer to the diagram below and use audio cables to make the connections.

### ⚠ CAUTION

When the Clavinova's AUX OUT jacks are connected to an external audio system, first turn on the power to the Clavinova, then to the external audio system. Reverse this order when you turn the power off.

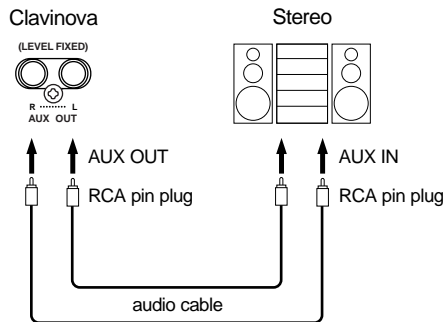

When these are connected (with RCA pin plug; LEVEL FIXED), the sound is output to the external device at a fixed level, regardless of the [MASTER VOLUME] slider setting.

### NOTE

Use audio cables and adaptor plugs with no resistance.

### NOTE

The Clavinova's [MASTER VOLUME] slider setting does not affect the signal output from the AUX OUT (LEVEL FIXED) jacks.

### NOTE

When the sound from the AUX OUT jacks is routed to the AUX IN jacks, the input sound will be output from the speaker of the CLP. The output sound may be excessively loud and may cause noise.



## 2 AUX IN [R] [L/L+R] jacks

The stereo outputs from another instrument can be connected to these jacks, allowing the sound of an external instrument to be reproduced via the Clavinova's speakers. Refer to the diagram below and use audio cables to make the connections.

### ⚠ CAUTION

When the Clavinova's AUX IN jacks are connected to an external device, first turn on the power to the external device, then to the Clavinova. Reverse this order when you turn the power off.

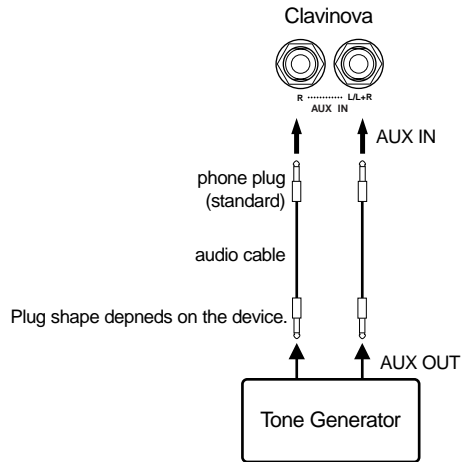

## 3 USB [TO DEVICE] terminal (CLP-240)

This terminal allows connection to USB storage devices. Refer to “Connection to a USB storage device” on page 58.

## 4 USB [TO HOST] terminal

This terminal allows direct connection to a personal computer. Refer to “Connecting a Personal Computer” on page 60 for more information.

## 5 MIDI [IN] [OUT] [THRU] terminals

Use MIDI cables to connect external MIDI devices to these connectors.

**MIDI [IN]:** Receives MIDI data.

**MIDI [OUT]:** Transmits MIDI data.

**MIDI [THRU]:** Transmits data received at the MIDI [IN] terminal as it is.

### About MIDI

MIDI (Musical Instrument Digital Interface) is a standard format for data transmission/reception. It enables the transfer of performance data and commands between MIDI devices and personal computers. Using MIDI, you can control a connected MIDI device from the Clavinova, or control the Clavinova from a connected MIDI device or computer.

### NOTE

The Clavinova's **[MASTER VOLUME]** slider setting affect the input signal from the AUX IN jacks, but the **[BRILLIANCE]**, **[REVERB]**, and **[EFFECT]** settings do not.

### NOTE

If you connect the Clavinova to a monaural device, use only the **AUX IN [L/L+R]** jack.

### NOTE

There are two different types of USB terminals on the instrument: **USB [TO DEVICE]** and **USB [TO HOST]**. Take care not to confuse the two terminals and the corresponding cable connectors. Be careful to connect the proper plug in the proper direction.

### NOTE

MIDI performance data and commands are transferred in the form of numeric values.

### NOTE

Since MIDI data that can be transmitted or received varies depending on the type of MIDI device, check the “MIDI Implementation Chart” to find out what MIDI data and commands your devices can transmit or receive. The Clavinova's MIDI Implementation Chart appears on page 84.

## Connection to a USB storage device (CLP-240)

By connecting the instrument to a USB storage device with a standard USB cable, you can save data you've created to the connected device, as well as read data from the connected device.

### Compatible USB storage devices

A USB storage device, such as a floppy disk drive, hard disk drive, CD-ROM drive, flash memory reader/writer, etc., can be connected to the **USB [TO DEVICE]** terminal. Other USB devices such as a computer keyboard or mouse cannot be used.

The instrument does not necessarily support all commercially available USB storage devices. Yamaha cannot guarantee operation of USB storage devices that you purchase. Before purchasing USB storage devices, please consult your Yamaha dealer, or an authorized Yamaha distributor (see list at end of the Owner's Manual) for advice, or visit the following web page:  
<http://music.yamaha.com/CLP-240/>  
<http://music.yamaha.com/CLP-230/>

### CAUTION

Avoid frequently turning the power on/off to the USB storage device, or connecting/disconnecting the cable too often. Doing so may result in the operation of the instrument "freezing" or hanging up. While the instrument is accessing data (such as during Save, Export, Copy, Delete, Load and Format operations) or is mounting the USB storage device (shortly after the connection: until the FILE LOAD LED flash stops), do NOT unplug the USB cable, do NOT remove the media from the device, and do NOT turn the power off to either devices. Doing so may corrupt the data on either or both devices.

### Connection to a USB storage device

This instrument has two **USB [TO DEVICE]** terminals; one on the left of the panel and one on the terminal at the bottom.

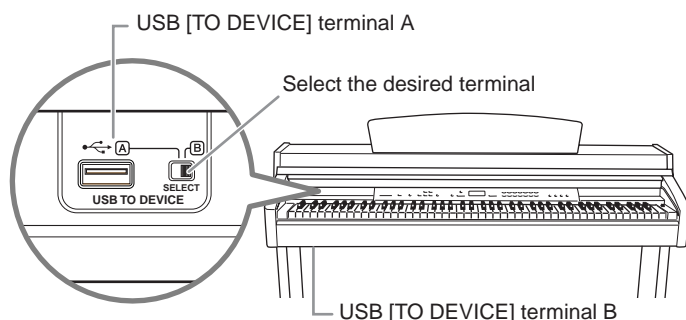

Both are the same terminal; however, both cannot be used at the same time. Use the **[SELECT]** switch to select the desired terminal. Switching to "A" selects the terminal on the left of the panel, while switching to "B" selects the terminal panel at the bottom. When the device is mounting, the FILE "LOAD" indicator flashes. When the mounting operation is completed, the indicator goes off.

### CAUTION

While the instrument is accessing data (such as in the Save, Export, Load, Delete or Format operations) or is mounting the USB storage device (shortly after the connection: until the FILE LOAD LED flash stops), do NOT use the **[SELECT]** switch. Doing so may corrupt the media or data.

### CAUTION

Disconnect the optional USB storage device connected to the **[USB TO DEVICE] A** terminal before closing the key cover. Closing the cover with the device still connected may damage the device.

### Formatting USB storage media

When executing a file-related operation with a connected USB storage device, a "For" message may appear, indicating that the device or media may be unformatted. If this happens, format the media (page 39).

### CAUTION

The format operation overwrites any previously existing data. Proceed with caution.

### NOTE

#### CD-ROM drive

Although CD-R/RW drives can be used to read data to the instrument, they cannot be used for saving data.

### NOTE

Do not use a non-ID SmartMedia card.

### NOTE

#### Number of USB storage devices

Only one USB storage device can be connected to the **USB [TO DEVICE]** terminal. This instrument can recognize only a single drive in a USB storage device. If one storage device contains more than one drive, only one drive will be automatically selected and recognized.

### NOTE

If you connect USB storage devices to both **USB [TO DEVICE]** terminals, the devices may not operate properly.

### NOTE

Though the instrument supports the USB 1.1 standard, you can connect and use a USB 2.0 storage device with the instrument. However, note that the transfer speed is that of USB 1.1.

**To protect your data (write-protect):**

To prevent important data from being inadvertently erased, apply the write-protect provided with each storage device or media. If you are saving data to the USB storage device, make sure to disable write-protect.

**To display the data in the USB storage device**

To view the data of the USB storage device on the CLP display, press the [SONG SELECT] button a few times until the “USER” indicator lights (pages 42-43).

**Backing up your data to a computer****■ Backing up the instrument data to a computer**

Once you've saved data to a USB storage device, you can copy the data to the hard disk of your computer, then archive and organize the files as desired. Simply reconnect the device as shown below.

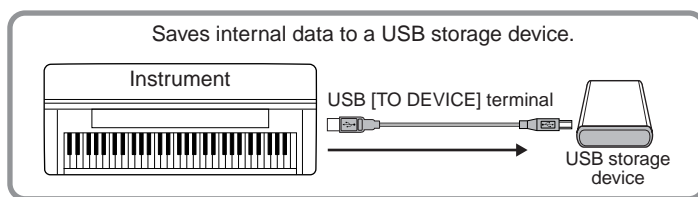

Disconnect the USB storage device from the instrument and connect it to the computer.

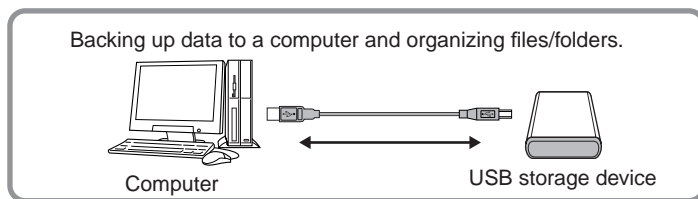
**■ Copying files from a computer hard disk to a USB storage device**

Files contained on the hard disk of a computer can be transferred to the instrument by first copying them to the storage media, then connecting/inserting the media to the instrument. Not only files created on the instrument itself but also Standard MIDI files created on other devices can be copied to a USB storage device from the hard disk of the computer. Once you've copied the data, connect the device to the USB [TO DEVICE] terminal of the instrument, and play back the data on the instrument.

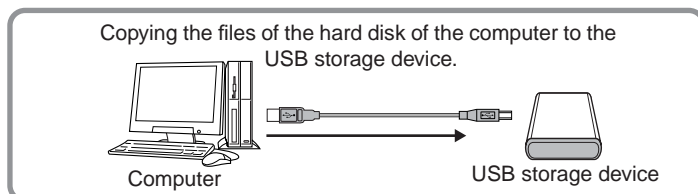

Disconnect the USB storage device from the computer and connect it to the instrument.

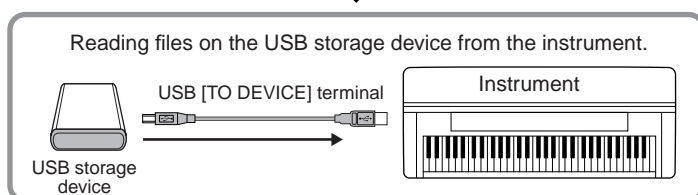

# Connecting a Personal Computer

By connecting a computer to the Clavinova's USB [TO HOST] terminal, you can transfer data between the instrument and the computer via MIDI. To do this, install the USB MIDI driver and Musicsoft Downloader software from the included CD-ROM.

## **CAUTION**

When connecting the Clavinova to a personal computer, first turn off the power to both the Clavinova and the computer before connecting any cables. After making connections, turn on the power to the computer first, then to the Clavinova.

## **CAUTION**

If you are not using the connection between the Clavinova and your computer, you must disconnect the cable from the USB [TO HOST] terminal. The Clavinova may not operate correctly if a cable is left connected.

Use a USB cable to connect the USB port on your computer to the USB [TO HOST] terminal on the Clavinova.

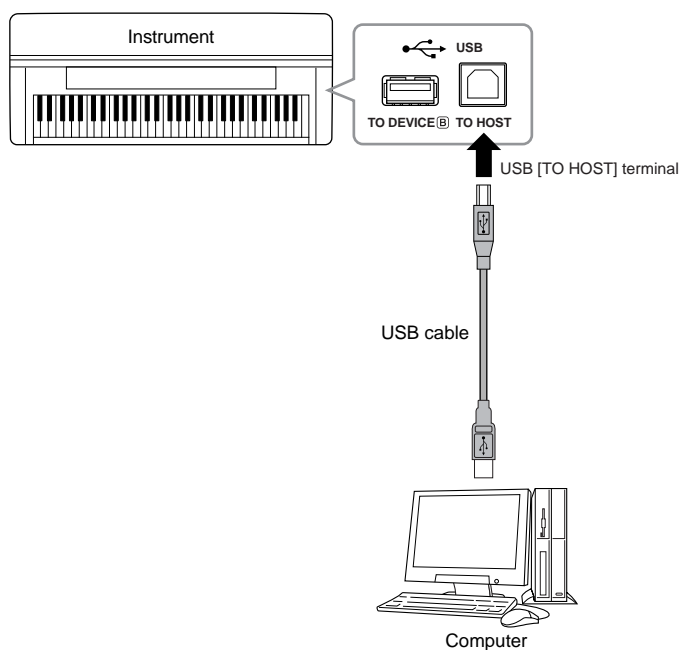

## TERMINOLOGY

### Driver:

A driver is software that provides a data-transfer interface between the computer's operating system and a connected hardware device. You need to install a USB MIDI driver to connect the computer and the instrument.

## NOTE

- The instrument will begin transmission a short time after the USB connection is made.
- When using a USB cable to connect the instrument to your computer, make the connection directly without passing through a USB hub.
- For information on setting up your sequence software, refer to the owner's manual of the relevant software.

### Precautions when using the USB [TO HOST] terminal

When connecting the computer to the USB [TO HOST] terminal, make sure to observe the following points. Failing to do so risks freezing the computer and corrupting or even losing the data. If the computer or the instrument freezes, turn the power to the instrument off or restart the computer.

#### **CAUTION**

- Before connecting the computer to the USB [TO HOST] terminal, exit from any power-saving mode (such as suspended, sleep, standby) of the computer.
- Before turning on the power to the instrument, connect the computer to the USB [TO HOST] terminal.
- Execute the following before turning the power to the instrument on/off or plugging/unplugging the USB cable to/from the USB [TO HOST] terminal.
  - Quit any open applications (such as Voice Editor, Multi Part Editor, and sequencer software).
  - Make sure that data is not being transmitted from the instrument. (Data is transmitted only by playing notes on the keyboard or playing back a song.)
- While a USB device is connected to the instrument, you should wait for six seconds or more between these operations: (1) when turning the power of the instrument off then on again, or (2) when alternately connecting/disconnecting the USB cable.

# Data Backup

For maximum data security Yamaha recommends that you save your important data to your computer by using the included application Musicsoft Downloader (MSD). This provides a convenient backup if the internal memory is damaged.

## Data that can be saved

### 1. Panel settings and recorded User songs

Panel settings are the same data that can be backed up using the Backup Functions (page 55). You can save the panel settings and recorded User songs as one file.

### 2. External songs received via computer.

## Procedure

### 1. Install the USB MIDI driver and the MSD from the included Accessory CD-ROM to your computer (Windows), then connect the computer and the instrument.

For installation, see the separate Installation Guide.  
For connection, see page 56.

### 2. Move the data to the computer.

By using the MSD, save the “CLP-xxx.BUP” file from “System Drive” under “Electronic Musical Instruments” to the computer.

The “CLP-xxx.BUP” file contains the panel settings and recorded User songs.

Also, if you store the external songs in the instrument from the computer, move the songs from “Flash Memory” under “Electronic Musical Instruments” to the computer via the MSD.

For instruction on using the MSD, see the Help in the MSD.

To recall the settings and load the songs to the instrument, move the “CLP-xxx.BUP” file and the External songs under the folders to which you saved the files.

#### NOTE

The file described in #1 at left cannot be saved to a USB storage device (CLP-240).

#### NOTE

When MSD is started on a computer connected to the instrument, “con (computer connection)” appears in the display. When this indication appears, you cannot operate the instrument.

#### NOTE



The Musicsoft Downloader cannot be used when the instrument is in the following state:

- During Demo mode.
- During song playback.
- During Record mode.
- During file operation (one of the [FILE] button indicators is lit).

#### NOTE

The panel settings and User songs (CLP-xxx.BUP file) remain in the instrument after being saved to the computer.

# Message List

Message	Comment
CLr	<p>Displayed after factory presets are recalled.</p> <p> <b>CAUTION</b></p> <p>Do not turn off the power of the instrument when "CLr" appears in the display. Doing so may delete all song data in the instrument, including external songs (page 40).</p>
con	<p>Displayed when Musicsoft Downloader is started on a computer connected to the instrument. When this message appears, you cannot operate the instrument.</p>
E01	<p>Indicates failure in accessing the USB storage device because the device or media is damaged.</p>
E02	<p>Displayed when the song data is damaged.</p>
E04	<p>Indicates that the song data is too large to be loaded.</p>
End	<p>Displayed when the current operation is completed.</p>
Err	<p>Displayed when the MIDI/USB cable is disconnected while starting Musicsoft Downloader on a computer connected to the instrument.</p>
FCL	<p>Indicates that internal memory has been cleaned up. Recorded songs and external songs which have been loaded from a computer are cleared, because the power has been turned off before the song save or load operations were completed.</p> <p> <b>CAUTION</b></p> <p>Do not turn off the power of the instrument when "FCL" appears in the display. Doing so may cause the instrument to malfunction.</p>
For	<p>Indicates that the instrument has engaged format mode for the USB storage device.</p>
Full	<p>Displayed when internal memory becomes full during song recording.</p>
	<p>Displayed when the USB storage device becomes full and the song cannot be saved.</p>
	<p>Displayed when the total amount of files has become too large.</p>
Lod	<p>Displayed when a protected song is loading.</p>
n y	<p>Confirms whether each operation is executed or not.</p>
n~y	<p>Reconfirms whether the overwriting, delete or format operation is executed or not.</p>
Pro	<p>Indicates that the USB storage device or media is protected.</p>

# Troubleshooting

Problem	Possible Cause and Solution
The Clavinova does not turn on.	The Clavinova has not been plugged in properly. Securely insert the female plug into the socket on the Clavinova, and the male plug into a proper AC outlet (page 11).
A click or pop is heard when the power is turned on or off.	This is normal when electrical current is being applied to the instrument.
Noise is heard from the speakers or headphones.	The noise may be due to interference caused by the use of a mobile phone in close proximity to the Clavinova. Turn off the mobile phone, or use it further away from the Clavinova.
The overall volume is low, or no sound is heard.	<ul style="list-style-type: none"> <li>• The Master Volume is set too low; set it to an appropriate level using the [MASTER VOLUME] control.</li> <li>• Make sure a pair of headphones is not connected to the headphones jack (when the SPEAKER switch is set to the "NORMAL" position). If the SPEAKER switch is set to the "OFF" position, set it to "NORMAL" or "ON" (page 12).</li> <li>• Make sure that Local Control (page 53) is ON.</li> </ul>
The speakers do not switch off when a pair of headphones is connected.	The SPEAKER switch may be switched "ON." Set the SPEAKER switch to the "NORMAL" position (page 12).
The damper pedal has no effect, or the sound continuously sustains even when the damper pedal is not pressed.	The pedal cable/plug may not be properly connected. Make sure to securely insert the pedal plug into the proper jack (page 67).
(CLP-240) Even though a USB storage device is connected, the SONG SELECT "USB" indicator does not turn on when pressing the [SONG SELECT] button.	<p>The USB storage device may not be recognized by the instrument, depending on the device itself or the timing of the recognition.</p> <ol style="list-style-type: none"> <li>1. Check the [SELECT] switch. Switching to "A" selects the terminal on the left of the panel, while switching to "B" selects the terminal panel at the bottom.</li> <li>2. Check that the device is not damaged. Check that the FILE "LOAD" indicator flashes after connecting the USB storage device. If the indicator does not flash, the device may be damaged.</li> <li>3. Check that the compatibility of the device has been confirmed by Yamaha (page 58).</li> <li>4. Select SONG SELECT "USB" again. It may take a while for the instrument to recognize the USB storage device. Press the [SONG SELECT] button again to turn the "USB" indicator on.</li> </ol>
(CLP-240) The USB storage device has hung up (stopped).	<ul style="list-style-type: none"> <li>• The USB storage device is not compatible with the instrument. Only use the devices whose compatibility has been confirmed by Yamaha (page 58).</li> <li>• Disconnect the device and connect it to the instrument again.</li> </ul>

## Options

### BC-100 Bench

A comfortable bench styled to match your Yamaha Clavinova.

### HPE-160 Stereo Headphones

High-performance lightweight dynamic headphones with extra-soft ear pads.

### UD-FD01 USB-FDD Unit (CLP-240)

Floppy disk drive for connecting to the instrument and saving/loading data.



# CLP-240/230: Keyboard Stand Assembly

## ⚠ CAUTION

- Be careful not to confuse parts, and be sure to install all parts in the correct direction. Please assemble the unit in the appropriate sequence.
- Assembly should be carried out by at least two persons.
- Be sure to use the correct screw size. Using of incorrect screws can cause damage.
- Be sure to tighten all screws upon completing assembly of each unit.
- To disassemble, reverse the assembly sequence.

Have a Phillips-head (+) screwdriver ready.

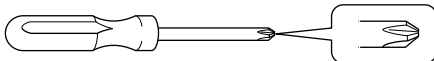

Remove all parts from the box. Confirm that all parts shown in the illustration are provided.

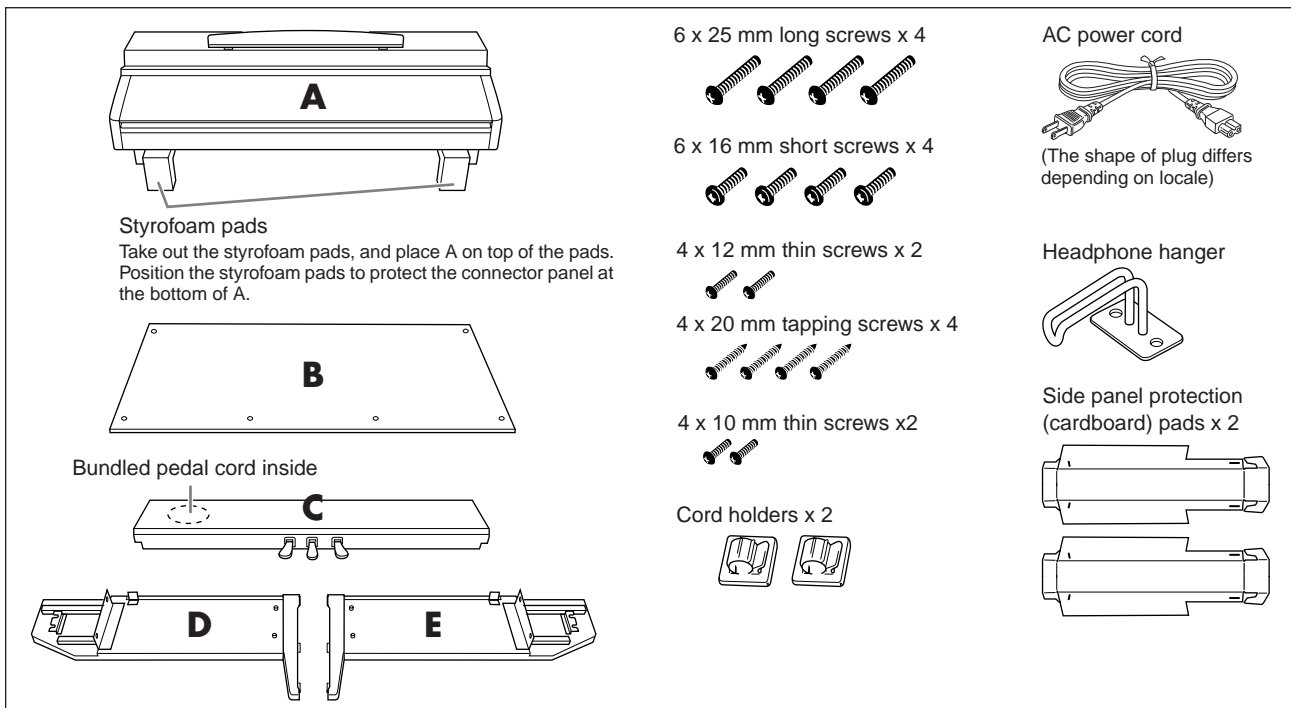

## 1. Attach D and E to C.

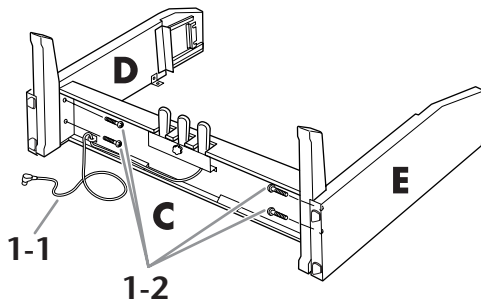

**1-1** Untie and straighten out the bundled cord. Don't discard the twist tie, you'll need it later in step 5.

**1-2** Secure C using the four 6 x 25 mm long screws.

## 2. Attach B.

**2-1** Place the bottom edges of B on the feet's protruding edges of D and E, then, secure the top part in alignment with the protruding edges.

**2-2** Temporarily secure the top part using 4 x 12 mm thin screws.

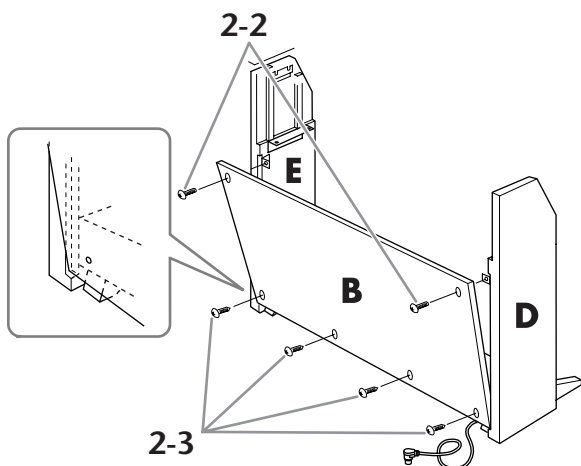

**2-3** Temporarily secure the bottom part using four 4 x 20 mm tapping screws.

**2-4** If you assembled the stand on an unlevel surface, place the assemble stand on a level surface.

## 3. Mount A.

**3-1** Assemble the side panel protection (cardboard) pad, as shown in the illustration. Then, remove the two backing papers from the adhesive tape on the protection pad.

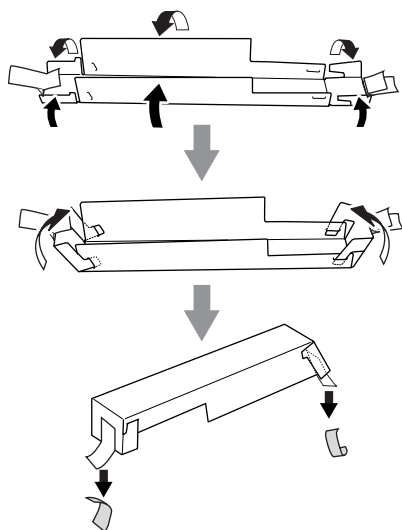

**3-2** Cover the top of D and E with the side panel protection pad. Then, fix the protection pad with the adhesive tape.

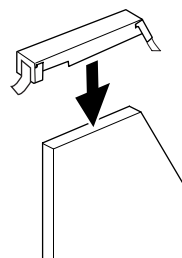

**3-3** Align the dimple on side A with the inner side of D and E. Simultaneously lower the left and right side of A, and secure with D and E.

### ! CAUTION

- Fingers can become pinched between the main unit and the rear or side panels, be extra careful so as not to drop the main unit.
- Do not hold the keyboard in any position other than the position shown in the illustration.

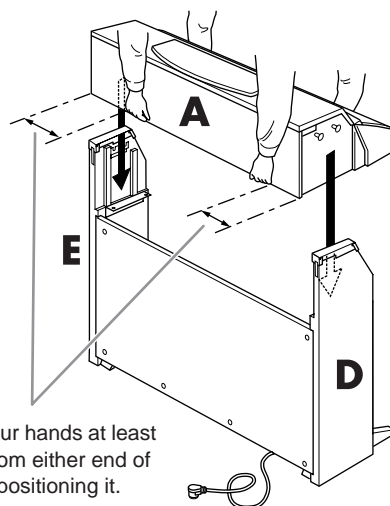

**3-4** Support the backside of D and E with your hand, and slightly push A in from the keyboard side until it stops.

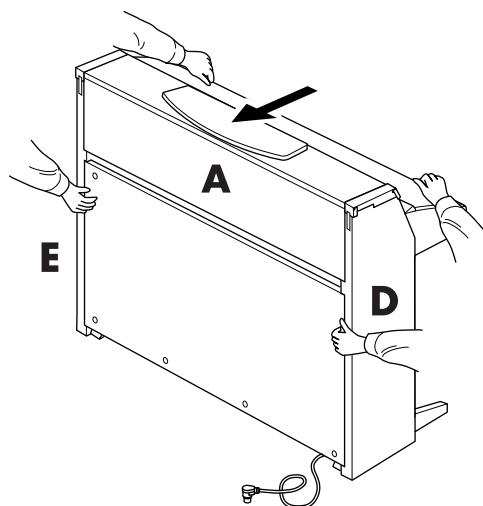

**3-5** Remove the side panel protection pad.

## 4. Attach A.

**4-1** Secure A using 6 x 16 mm short screws from the front.

**4-2** Firmly tighten the screws you temporarily secured in steps 2-2 and 2-3 above (assembly B). Tighten these in order starting with the top side first, then the bottom. Make sure as you do this that the spaces on the left and right sides (indicated by ① and ② below) are even.

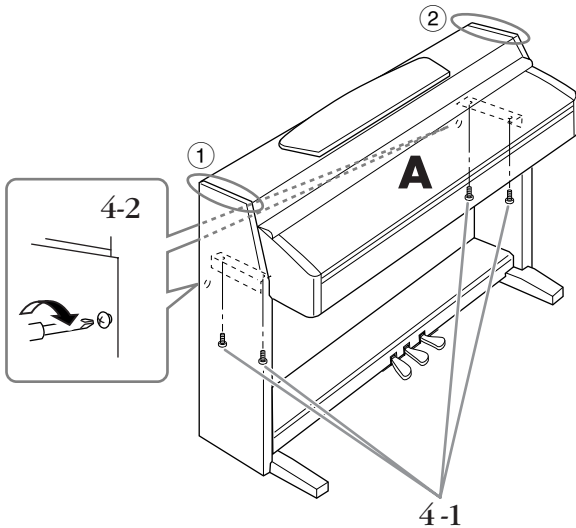

## 5. Connect the pedal cord.

**5-1** Insert the pedal cord plug to the pedal connector from the front.

**5-2** Attach the cord holders to B, then clip the cord into the holders.

**5-3** Use a twist tie to bundle the pedal cord.

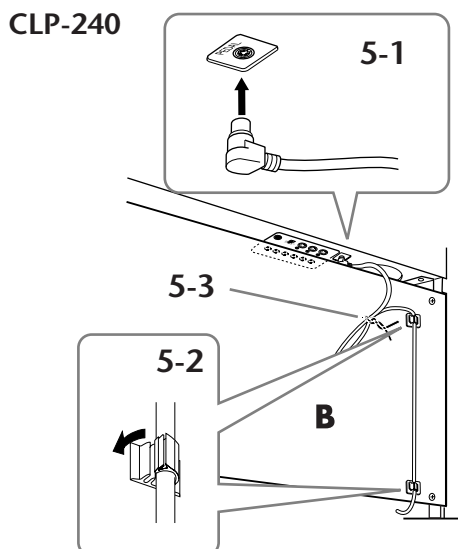

CLP-230

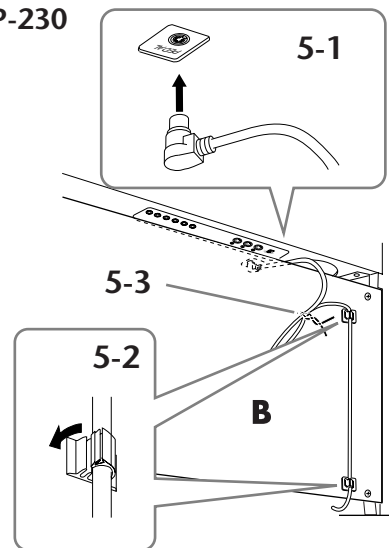

## 6. Connect the power cord.

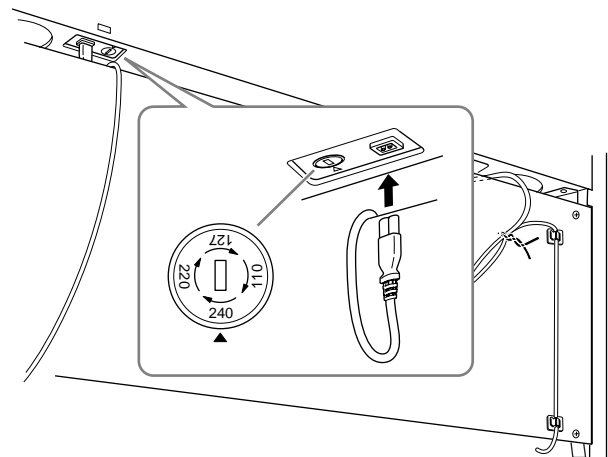

Insert the AC power cord plug into the AC INLET.

For models that feature a voltage selector:

Set the voltage selector to an appropriate voltage.

### Voltage Selector

Before connecting the AC power cord, check the setting of the voltage selector which is provided in some areas. To set the selector for 110V, 127V, 220V or 240V main voltages, use a "minus" screwdriver to rotate the selector dial so that the correct voltage for your region appears next to the pointer on the panel. The voltage selector is set at 240V when the unit is initially shipped. After the proper voltage has been selected, connect the AC power cord to the AC INLET and an AC wall outlet. A plug adaptor may be also provided in some areas to match the pin configuration of the AC wall outlets in your area.

### ⚠ WARNING

An improper voltage setting can cause serious damage to the Clavinova or result in improper operation.

## 7. Set the adjuster.

Rotate the adjuster until it comes in firm contact with the floor surface.

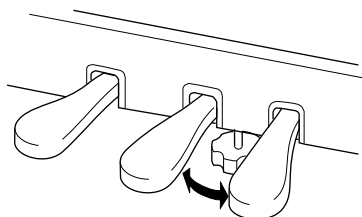

## 8. Attach the headphone hanger.

You can attach a headphone hanger on the Clavinova to hang the headphones.

Install the headphone hanger using included two screws (4 x 10mm) as shown in the figure.

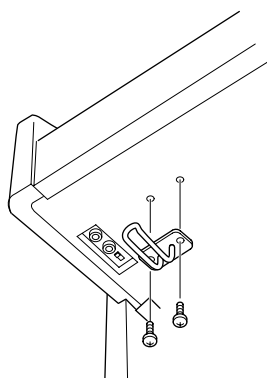

After completing the assembly, please check the following.

- **Are there any parts left over?**  
Review the assembly procedure and correct any errors.
- **Is the Clavinova clear of doors and other movable fixtures?**  
Move the Clavinova to an appropriate location.
- **Does the Clavinova make a rattling noise when you shake it?**  
Tighten all screws.
- **Does the pedal box rattle or give way when you step on the pedals?**  
Turn the adjuster so that it is set firmly against the floor.
- **Are the pedal and power cords inserted securely into the sockets?**  
Check the connection.
- **If the main unit creaks or is otherwise unsteady when you play on the keyboard, refer to the assembly diagrams and retighten all screws.**

When moving the instrument after assembly, always hold the bottom of the main unit.

### **⚠ CAUTION**

Do not hold the key cover or top portion. Improper handling can result in damage to the instrument or personal injury.

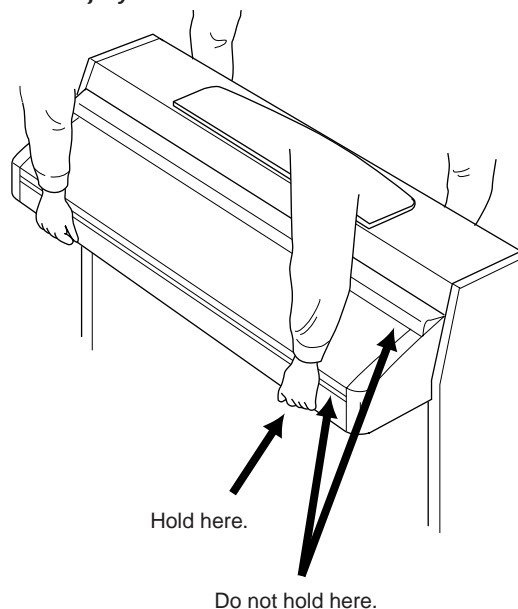

# Handling the Floppy Disk Drive (FDD) and Floppy Disks (CLP-240)

**An optional floppy disk drive can be installed to the CLP-240. For instructions on installing the floppy disk drive, see page 70.**

The floppy disk drive lets you save original data you've created on the instrument to floppy disk, and allows you to load data from floppy disk to the instrument. Be sure to handle floppy disks and treat the disk drive with care. Follow the important precautions below.

## Floppy Disk Compatibility

- 3.5" 2DD and 2HD type floppy disks can be used.

## Formatting a Floppy Disk

- If you find that you are unable to use new, blank disks or old disks that have been used with other devices, you may need to format them. For details on how to format a disk, see page 39. Keep in mind that all data on the disk will be lost after formatting. Make sure to check beforehand whether or not the disk contains important data.

### NOTE

Floppy disks formatted on this device may or may not be useable as is on other devices.

## Inserting/Removing Floppy Disks

### Inserting a Floppy Disk into the Disk Drive:

Hold the disk so that the label of the disk is facing upward and the sliding shutter is facing forward, towards the disk slot. Carefully insert the disk into the slot, slowly pushing it all the way in until it clicks into place and the eject button pops out.

### NOTE

Never insert anything but floppy disks into the disk drive. Other objects may cause damage to the disk drive or floppy disks.

### Removing a Floppy Disk

- After checking that the instrument is not accessing\* the floppy disk (checking that the use lamp on the floppy disk drive is off), firmly press the eject button at the upper right of the disk slot all the way in.

When the floppy disk is ejected, pull it out of the drive. If the floppy disk cannot be removed because it is stuck, do not try to force it, but instead try pressing the eject button again, or try re-inserting the disk and attempt to eject it again.

\* Access of the disk indicates an active operation, such as recording, playback, or deletion of data.

If a floppy disk is inserted while the power is on, the disk is automatically accessed, since the instrument checks whether the disk has data.

### CAUTION

Do not remove the floppy disk or turn off the instrument itself while the disk is being accessed.

Doing so may result not only in loss of data on the disk but also damage to the floppy disk drive.

- Be sure to remove the floppy disk from the disk drive before turning off the power. A floppy disk left in the drive for extended periods can easily pick up dust and dirt that can cause data-read and -write errors.

## Cleaning the Disk Drive Read/Write Head

- Clean the read/write head regularly. This instrument employs a precision magnetic read/write head which, after an extended period of use, will pick up a layer of magnetic particles from the disks used that will eventually cause read and write errors.
- To maintain the disk drive in optimum working order Yamaha recommends that you use a commercially-available dry-type head cleaning disk to clean the head about once a month. Ask your Yamaha dealer about the availability of proper head cleaning disks.

## About Floppy Disks

**Handle floppy disks with care, and follow these precautions:**

- Do not place heavy objects on a disk or bend or apply pressure to the disk in any way. Always keep floppy disks in their protective cases when they are not in use.
- Do not expose the disk to direct sunlight, extremely high or low temperatures, or excessive humidity, dust or liquids.
- Do not open the sliding shutter and touch the exposed surface of the floppy disk inside.
- Do not expose the disk to magnetic fields, such as those produced by televisions, speakers, motors, etc., since magnetic fields can partially or completely erase data on the disk, rendering it unreadable.
- Never use a floppy disk with a deformed shutter or housing.
- Do not attach anything other than the provided labels to a floppy disk. Also make sure that labels are attached in the proper location.

### To Protect Your Data (Write-protect Tab):

- To prevent accidental erasure of important data, slide the disk's write-protect tab to the "protect" position (tab open). When saving data, make sure that the disk's write-protect tab is set to the "overwrite" position (tab closed).

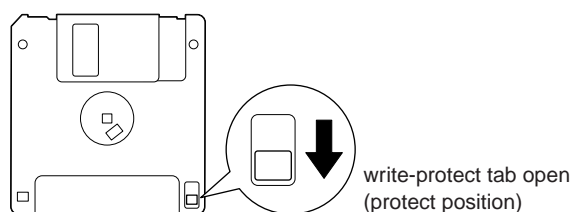

# Installing the Floppy Disk Drive (Optional)

The optional UD-FD01 floppy disk drive can be installed to the bottom of the CLP-240 by using the included floppy disk drive case and screws.

Have a Phillips-head (+) screwdriver ready.

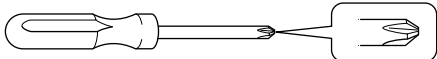

ENGLISH

- 1. Remove the three backing papers from the adhesive tape in the case, and fit the floppy disk drive into the case.**

Insert the drive to the case, with the side having the rubber stoppers facing the case.

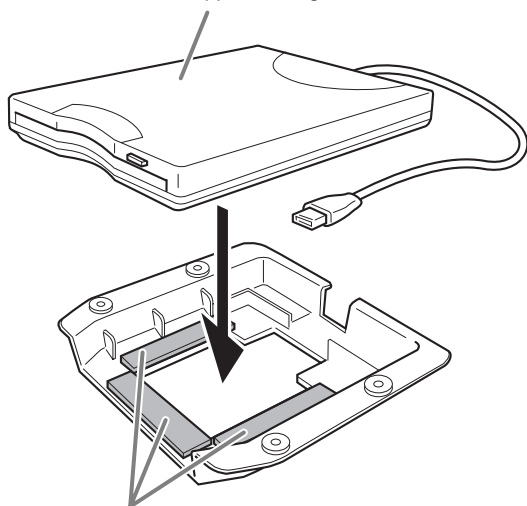

Dual-sided adhesive tape

- 2. Fold the USB cable inside the case as shown.**

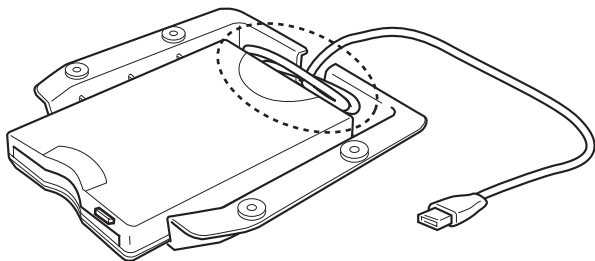

- 3. Attach the drive and case assembly to the left underside of the instrument, using the included four screws (4mm x 10mm).**

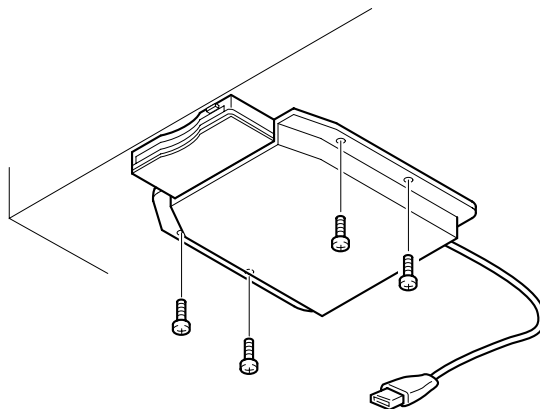

- 4. Connect the USB cable to the USB [TO DEVICE] terminal.**

# Preset Voice List

CLP-240

○: Yes  
—: No

Voice Name	Stereo Sampling	Touch Response	Dynamic Sampling <sup>*1</sup>	Key-Off Sampling <sup>*2</sup>	Voice Descriptions
<b>GRANDPIANO 1</b>	○	○	○	○	Recorded samples from a full concert grand piano. Also includes three levels of dynamic sampling, sustain samples, and key-off samples for exceptionally realistic acoustic grand piano sound. Perfect for classical compositions as well as any other style that requires acoustic piano.
<b>VARIATION</b>	○	○	○	○	Warm and mellow piano. Good for classical compositions.
<b>GRANDPIANO 2</b>	○	○	—	—	Spacious and clear piano with bright reverb. Good for popular music.
<b>VARIATION</b>	○	○	—	—	Bright, spacious piano. Good for popular or rock music.
<b>E.PIANO 1</b>	—	○	○	—	An electronic piano sound created by FM synthesis. Extremely “musical” response with varying timbre according to keyboard dynamics. Good for standard popular music.
<b>VARIATION</b>	—	○	—	—	A synth-generated type electronic piano sound often heard in popular music. Used in the DUAL mode it blends well with an acoustic piano voice.
<b>E.PIANO 2</b>	—	○	○	—	The sound of an electric piano using hammer-struck metallic “tines”. Soft tone when played lightly, and an aggressive tone when played hard.
<b>VARIATION</b>	—	○	○	—	A slightly different electric piano sound often heard in rock and popular music.
<b>HARPSICHORD</b>	○	—	—	○	The definitive instrument for baroque music. Since harpsichord uses plucked strings, there is no touch response. There is, however, a characteristic additional sound when the keys are released.
<b>VARIATION</b>	○	—	—	○	Mixes the same voice an octave higher for a more brilliant tone.
<b>E. CLAVICHORD</b>	—	○	—	○	A hammer-struck keyboard instrument that utilizes an electric pickup that is often heard in funk and soul music. Its tone is noted for the unique sound produced when the keys are released.
<b>VARIATION</b>	—	○	—	○	Includes a unique preset effect.
<b>VIBRAPHONE</b>	○	○	○	—	Vibraphone played with relatively soft mallets. The tone becomes more metallic the harder you play.
<b>VARIATION</b>	○	○	—	—	Stereo-sampled, spacious, and realistic marimba.
<b>CHURCH ORGAN</b>	○	—	—	—	This is a typical pipe organ sound (8 feet + 4 feet + 2 feet). Good for sacred music from the Baroque period.
<b>VARIATION</b>	○	—	—	—	This is the organ's full coupler sound often associated with Bach's “Tocatta and Fugue”.
<b>JAZZ ORGAN</b>	—	—	—	—	The sound of a “tonewheel” type electric organ. Often heard in jazz and rock idioms.
<b>VARIATION</b>	—	—	—	—	Uses a rotary speaker effect with a different speed. The variations speed is faster. If the variation is selected while holding a chord, the speed of the effect will gradually change.
<b>STRINGS</b>	○	○	—	—	Stereo-sampled, large-scale strings ensemble with realistic reverb. Try combining this voice with piano in the DUAL mode.
<b>VARIATION</b>	○	○	—	—	Spacious strings ensemble with a slow attack. Try combining this voice with a piano or electric piano in the DUAL mode.
<b>CHOIR</b>	—	○	—	—	A big, spacious choir voice. Perfect for creating rich harmonies in slow pieces.



Voice Name	Stereo Sampling	Touch Response	Dynamic Sampling <sup>*1</sup>	Key-Off Sampling <sup>*2</sup>	Voice Descriptions
<b>VARIATION</b>	—	○	—	—	A choir voice with a slow attack. Try combining this voice with a piano or electric piano in the DUAL mode.
<b>GUITAR</b>	—	○	—	—	Warm and natural-sounding nylon guitar. Enjoy the quiet ambience of nylon strings.
<b>VARIATION</b>	—	○	—	—	Bright, brilliant steel guitar. Suitable for popular music.
<b>WOOD BASS</b>	—	○	—	—	An upright bass played fingerstyle. Ideal for jazz and Latin music.
<b>VARIATION</b>	—	○	—	—	Adds a cymbal voice to the bass sound. Ideal for walking bass lines in jazz tunes.
<b>E.BASS</b>	—	○	—	—	Electric bass for a wide range of music styles, jazz, rock, popular, and more.
<b>VARIATION</b>	—	○	—	—	A fretless bass good for styles such as jazz, fusion, etc.

\*1. Dynamic Sampling provides multiple velocity-switched samples to accurately simulate the timbral response of an acoustic instrument.

\*2. Contains a very subtle sample that is produced when the keys are released.



○: Yes  
—: No

## CLP-230

Voice Name	Stereo Sampling	Touch Response	Dynamic Sampling <sup>*1</sup>	Key-Off Sampling <sup>*2</sup>	Voice Descriptions
GRANDPIANO 1	○	○	—	—	Recorded samples from a full concert grand piano. Perfect for classical compositions as well as any other style that requires acoustic piano.
GRANDPIANO 2	○	○	—	—	Spacious and clear piano with bright reverb. Good for popular music.
E.PIANO 1	—	○	○	—	An electronic piano sound created by FM synthesis. Good for standard popular music.
E.PIANO 2	—	○	○	—	The sound of an electric piano using hammer-struck metallic “tines”. Soft tone when played lightly, and an aggressive tone when played hard.
HARPSICHORD 1	○	—	—	○	The definitive instrument for baroque music. Since harpsichord uses plucked strings, there is no touch response. There is, however, a characteristic additional sound when the keys are released.
HARPSICHORD 2	○	—	—	○	Mixes the same voice an octave higher for a more brilliant tone.
VIBRAPHONE	○	○	○	—	Vibraphone played with relatively soft mallets. The tone becomes more metallic the harder you play.
CHURCH ORGAN 1	○	—	—	—	This is a typical pipe organ sound (8 feet + 4 feet + 2 feet). Good for sacred music from the Baroque period.
CHURCH ORGAN 2	○	—	—	—	This is the organ’s full coupler sound often associated with Bach’s “Toccatina and Fugue”.
JAZZ ORGAN	—	—	—	—	The sound of a “tonewheel” type electric organ. Often heard in jazz and rock idioms.
STRINGS 1	○	○	—	—	Stereo-sampled, large-scale strings ensemble with realistic reverb. Try combining this voice with piano in the DUAL mode.
STRINGS 2	○	○	—	—	Spacious strings ensemble with a slow attack. Try combining this voice with a piano or electric piano in the DUAL mode.
CHOIR	—	○	—	—	A big, spacious choir voice. Perfect for creating rich harmonies in slow pieces.
GUITAR	—	○	—	—	Warm and natural-sounding nylon guitar. Enjoy the quiet ambience of nylon strings.

\*1. Dynamic Sampling provides multiple velocity-switched samples to accurately simulate the timbral response of an acoustic instrument.

\*2. Contains a very subtle sample that is produced when the keys are released.

# Demo Song List

○: Included  
—: Not included

Voice Name	CLP-240	CLP-230	Title	Composer
GRAND PIANO1	○	○	“Eintritt” Waldszenen Op.82	R. Schumann
HARPSICHORD	○	—	Gavotte	J.S. Bach
HARPSICHORD1	—	○		
HARPSICHORD2	—	○	Invention No.1	

The demonstration pieces listed above are short rearranged excerpts of the original compositions.  
All other songs are original (©2005 Yamaha Corporation).

## Piano Voice Demo Description (CLP-240)

Voice Name	Piano Voice Demo
GRAND PIANO1	Stereo sampling
GRAND PIANO2	Monaural sampling
E.PIANO1	Dynamic sampling; mezzo piano
E.PIANO2	Dynamic sampling; mezzo forte
HARPSICHORD	Dynamic sampling; forte
E.CLAVICHORD	With sustain sampling
VIBRAPHONE	Without sustain sampling
CHURCH ORGAN	With key-off sampling
JAZZ ORGAN	Without key-off sampling

# Index

## Numerics

- 50 Greats for the Piano ..... 15  
 50 Piano Preset Songs ..... 15

## A

- A-B Repeat ..... 18  
 Adjust  
   Tempo (50 Piano Preset Songs) ..... 15  
   Tempo (Recorded Songs) ..... 41  
   Volume (50 Piano Preset Songs) ..... 15  
   Volume (Metronome) ..... 52  
 ALL (LED display) ..... 15, 43  
 Assembly ..... 65–68  
 AUX IN ..... 57  
 AUX OUT ..... 56

## B

- Backup (data) ..... 62  
 Backup Functions ..... 55  
 [BRILLIANCE] button ..... 21

## C

- Center Pedal ..... 20  
 Character Code ..... 55  
 Combining Two Voices (Dual mode) ..... 25  
 Connecting a Personal Computer ..... 60  
 Connection to a USB storage device (CLP-240) ..... 58  
 Connections ..... 56  
   Computer ..... 60  
   USB storage device ..... 58  
 Connectors ..... 56

## D

- Damper Pedal ..... 20, 50  
 [DDE] button (CLP-240) ..... 22  
 Delete ..... 38  
 [DEMO] button ..... 14  
 Demo Song List ..... 74  
 Detailed Settings (FUNCTION) ..... 44  
 Display ..... 11  
 Dual mode ..... 25, 49

## E

- [EFFECT] button ..... 21  
 Effects ..... 22  
 Export ..... 35

## F

- Factory Setting List ..... 78  
 [FILE] button ..... 42  
 Fine Tuning of the Pitch ..... 47  
 Floppy Disk (CLP-240) ..... 69  
 Floppy Disk Drive  
   Installation (CLP-240) ..... 70  
 Format ..... 39  
 FUNCTION ..... 47–55  
   Basic Procedure ..... 45

## K

- Key Cover ..... 10

## L

- [LEFT] button ..... 17, 32  
 Left Pedal ..... 20, 51  
 List  
   Demo Song ..... 74  
   Factory Setting ..... 78  
   Functions ..... 44  
   Preset Voice ..... 71–73  
 Load ..... 42

## M

- [MASTER VOLUME] slider ..... 12  
 Message List ..... 63  
 METRONOME [ON/OFF] button ..... 28, 52  
 Metronome Volume ..... 52  
 MIDI [IN] [OUT] [THRU] ..... 57  
 MIDI Data Format ..... 80  
 MIDI Functions ..... 52  
 MIDI Implementation Chart ..... 84  
 Music Braces (CLP-240) ..... 10  
 Music Rest ..... 10

**N**

Normal setting.....21

**P**

Part Cancel.....17

Part Playback On and Off.....43

[PEDAL] jack.....67

Pedals .....20

PHONES.....12

Piano Voice Demo Description.....74

Pitch → Fine Tuning of the Pitch.....47

PLAY/PAUSE (Demo) .....14

Play/Pause (Pedal).....43

[PLAY/PAUSE] button .....15, 41

Play/Pause playback

    Demonstration Tunes .....14

    Recorded Songs .....41

    Useful Playback Functions.....43

Playing Back Songs.....40

[POWER] switch.....11

Practicing a One-Hand Part Using 50 Preset Songs.....17

Preset songs → 50 Piano Preset Songs .....15

Preset Voice List .....71–73

**R**

[REC] button.....29

Recording.....29

    Initial Settings.....34

Repeat .....15, 18

Re-recording.....33

[REVERB] button .....21

[RIGHT] button.....17, 32

Right Pedal.....20

RIGHT/LEFT (50 Piano Preset Songs) .....17

rnd (LED display).....15, 43

**S**

Save .....35

Scale.....48

[SELECT] switch (CLP-240) .....58

SMF .....35

Soft Pedal .....20, 51

Song Part Cancel Volume .....52

Song playback.....40

[SONG SELECT] button .....15, 41, 42

Sostenuto Pedal .....20

[SPEAKER] switch.....12

Specifications.....85

SPLIT (CLP-240) (Function) .....50

[SPLIT] button (CLP-240) .....26

[STOP] button .....15, 41

Sustain Pedal .....51

Sync Start.....17, 43

**T**

TEMPO.....15, 41

TEMPO (METRONOME) .....28

[TEMPO/FUNCTION#] button.....28, 45

[TOUCH] button.....23

Touch Sensitivity.....23

Transporting .....3

[TRANSPOSE] button.....24

Troubleshooting.....64

Tuning → Fine Tuning of the Pitch.....47

**U**

USB storage device (CLP-240) .....58

USB [TO DEVICE] terminal (CLP-240) .....57

USB [TO HOST] terminal .....57

**V**

[VARIATION] button (CLP-240) .....21

VOICE .....19

Voice group buttons .....19

# Appendix

---

This section introduces reference material.  
In diesem Abschnitt finden Sie Referenzmaterial.  
Cette section présente le matériel de référence.  
En esta sección se incluye material de referencia.

Factory Setting List Liste der Vorgabeeinstellungen Liste des réglages Lista de ajustes de fábrica.....	78
MIDI Data Format MIDI-Datenformat Format des données MIDI Formato de datos MIDI .....	80
MIDI Implementation Chart MIDI Implementierung stabelle Feuille d'implantation MIDI Gráfica de implementación MIDI.....	84
Specifications Technische Daten Caractéristiques techniques Especificaciones.....	85

# Factory Setting List / Liste der Vorgabeeinstellungen / Liste des réglages / Lista de ajustes de fábrica

	Default	Backup Group	
		CLP-240	CLP-230
Voice	GRAND PIANO 1	F9.1	F8.1
Variation (CLP-240)	OFF		—
Dual Mode	OFF		F8.1
Split Mode (CLP-240)	OFF		—
Split Mode Left Voice (CLP-240)	WOOD BASS		—
Brilliance	NORMAL	F9.4	F8.4
Reverb Type	Preset for each voice	F9.1	F8.1
Reverb Depth	Preset for each voice		
Effect Type	Preset for each voice		
Effect Depth	Preset for each voice		
Touch Sensitivity	MEDIUM		
Volume in the FIXED Mode	64	F9.4	—
DDE (CLP-240)	ON		
DDE Depth (CLP-240)	6		
Metronome	OFF	—	—
Metronome Time Signature	0 (no accent)	F9.1	F8.1
Tempo	120	—	—
Transpose	0	F9.3	F8.3

## Function

CLP-240	CLP-230	Function	Default	Backup Group	
				CLP-240	CLP-230
F1	F1	Tuning	A3=440Hz	F9.3	F8.3
F2.1	F2.1	Scale	1 (Equal Temperament)		
F2.2	F2.2	Base Note	C		
F3.1	F3.1	Dual Balance	Preset for each voice combination	F9.1	F8.1
F3.2	F3.2	Dual Detune	Preset for each voice combination		
F3.3, F3.4	F3.3, F3.4	Dual Octave Shift	Preset for each voice combination		
F3.5, F3.6	F3.5, F3.6	Dual Effect Depth	Preset for each voice combination		
F4.1	—	Split Point	F#2		
F4.2	—	Split Balance	Preset for each voice combination		
F4.3, F4.4	—	Split Octave Shift	Preset for each voice combination		
F4.5, F4.6	—	Split Effect Depth	Preset for each voice combination		
F4.7	—	Damper Pedal Range	ALL	F9.4	F8.4
F5.1	F4.1	Left Pedal Mode	1 (Soft Pedal)		
F5.2	F4.2	Soft Pedal Effect Depth	3		
F5.3	—	Sustain Sample Depth	12		
F5.4	—	Keyoff Sample Volume	10		
F5.5	F4.3	Song Channel Selection	ALL	F9.1	F8.1
F6	F5	Metronome Volume	10		
F7	F6	Song Part Cancel Volume	5		

CLP-240	CLP-230	Function	Default	Backup Group	
				CLP-240	CLP-230
F8.1	F7.1	MIDI Transmit Channel	1	F9.2	F8.2
F8.2	F7.2	MIDI Receive Channel	ALL		
F8.3	F7.3	Local Control	ON		
F8.4	F7.4	Program Change Send & Receive	ON		
F8.5	F7.5	Control Change Send & Receive	ON		
F9	F8	Backup	Voice: OFF MIDI – Others: ON	Always backed up	
F9.5	F8.5	Character Code	En		

# MIDI Data Format / MIDI-Datenformat / Format des données MIDI / Formato de datos MIDI

If you're already very familiar with MIDI, or are using a computer to control your music hardware with computer-generated MIDI messages, the data provided in this section can help you to control the CLP-240/230.

Falls Sie bereits mit MIDI vertraut sind oder einen Computer zur Erzeugung von MIDI-Steuermeldungen für die Instrumente verwenden, können Sie sich zur Steuerung des CLP-240/230 nach den im folgenden Abschnitt aufgeführten Spezifikationen richten.

Si vous êtes très familier avec l'interface MIDI ou si vous utilisez un ordinateur pour commander votre matériel de musique au moyen de messages MIDI générés par ordinateur, les données suivantes vous seront utiles et vous aideront à commander le CLP-240/230.

Si usted está ya familiarizado con MIDI, o si emplea una computadora para controlar sus aparatos musicales con mensajes MIDI generados por computadora, los datos proporcionados en esta sección le ayudarán a controlar la CLP-240/230.

## 1. NOTE ON/OFF

Data format: [9nH] -> [kk] -> [vv]

9nH = Note ON/OFF event (n = channel number)

kk = Note number (Transmit: 09H ~ 78H = A-2 ~ C8 / Receive: 00H ~ 7FH = C-2 ~ G8)\*

vv = Velocity (Key ON = 01H ~ 7FH, Key OFF = 00H)

Data format: [8nH] -> [kk] -> [vv] (reception only)

8nH = Note OFF event (n = channel number)

kk = Note number: 00H ~ 7FH = C-2 ~ G8

vv = Velocity

\* If received value exceeds the supported range for the selected voice, the note is adjusted by the necessary number of octaves.

## 2. CONTROL CHANGE

Data format: [BnH] -> [cc] -> [vv]

BnH = Control change (n = channel number)

cc = Control number

vv = Data Range

### (1) Bank Select

ccH	Parameter	Data Range (vvH)
00H	Bank Select MSB	00H: Normal
20H	Bank Select LSB	00H...7FH

Bank selection processing does not occur until receipt of next Program Change message.

### (2) Modulation (reception only)

ccH	Parameter	Data Range (vvH)
01H	Modulation	00H-7FH

### (3) Main Volume (reception only)

ccH	Parameter	Data Range (vvH)
07H	Volume MSB	00H...7FH

### (4) Panpot (reception only)

ccH	Parameter	Data Range (vvH)
0AH	Panpot	00H-7FH

### (5) Expression

ccH	Parameter	Data Range (vvH)
0BH	Expression MSB	00H...7FH

### (6) Damper

ccH	Parameter	Data Range (vvH)
40H	Damper MSB	00H...7FH

### (7) Sostenuto

ccH	Parameter	Data Range (vvH)
42H	Sostenuto	00H-3FH:off, 40H-7FH:on

### (8) Soft Pedal

ccH	Parameter	Data Range (vvH)
43H	Soft Pedal	00H-3FH:off, 40H-7FH:on

### (9) Effect1 Depth (Reverb Send Level)

ccH	Parameter	Data Range (vvH)
5BH	Effect1 Depth	00H...7FH

Adjusts the reverb send level.

### (10) Effect4 Depth (Variation Effect Send Level)

ccH	Parameter	Data Range (vvH)
5EH	Effect4 Depth	00H...7FH

## (11) RPN

ccH	Parameter	Data Range (vvH)
65H	RPN MSB	Coarse Tune 02H, Fine Tune 01H, Pitch Bend Range 00H
64H	RPN LSB	
06H	Data Entry MSB	
38H	Data Entry LSB	

## 3. MODE MESSAGES

Data format: [BnH] -> [cc] -> [vv]

BnH = Control event (n = channel number)

cc = Control number

vv = Data Range

### (1) All Sound Off

ccH	Parameter	Data Range (vvH)
78H	All Sound Off	00H

Switches off all sound from the channel. Does not reset Note On and Hold On conditions established by Channel Messages.

### (2) Reset All Controllers

ccH	Parameter	Data Range (vvH)
79H	Reset All Controllers	00H

Resets controllers as follows.

Controller	Value
Expression	127 (max)
Damper Pedal	0 (off)
Sostenuto	0 (off)
Soft Pedal	0 (off)

### (3) Local Control (reception only)

ccH	Parameter	Data Range (vvH)
7AH	Local Control	00H (off), 7FH (on)

### (4) All Notes Off

ccH	Parameter	Data Range (vvH)
7BH	All Notes Off	00H

Switches OFF all the notes that are currently ON on the specified channel. Any notes being held by the damper or sostenuto pedal will continue to sound until the pedal is released.

### (5) Omni Off (reception only)

ccH	Parameter	Data Range (vvH)
7CH	Omni Off	00H

Same processing as for All Notes Off.

### (6) Omni On (reception only)

ccH	Parameter	Data Range (vvH)
7DH	Omni On	00H

Same processing as for All Notes Off.

### (7) Mono (reception only)

ccH	Parameter	Data Range (vvH)
7EH	Mono	00H

Same processing as for All Sound Off.

### (8) Poly (reception only)

ccH	Parameter	Data Range (vvH)
7FH	Poly	00H

Same processing as for All Sound Off.

- When control change reception is turned OFF in the Function mode, control change data will not be transmitted or received.
- Local on/off, OMNI on/off are not transmitted. (The appropriate note off number is supplied with "All Note Off" transmission).



- When a voice bank MSB/LSB is received, the number is stored in the internal buffer regardless of the received order, then the stored value is used to select the appropriate voice when a program change message is received.
- The Multi-timbre and Poly modes are always active. No change occurs when OMNI ON, OMNI OFF, MONO, or POLY mode messages are received.

#### 4. PROGRAM CHANGE

Data format: [CnH] -> [ppH]

CnH = Program event (n = channel number)

ppH = Program change number

P.C.#=Program Change number

CLP-240	CLP-230	MSB	LSB	P.C.#
GRANDPIANO 1	GRANDPIANO 1	0	122	0
VARIATION	—	0	123	0
GRANDPIANO 2	GRANDPIANO 2	0	112	0
VARIATION	—	0	112	1
E.PIANO 1	E.PIANO 1	0	122	5
VARIATION	—	0	122	88
E.PIANO 2	E.PIANO 2	0	122	4
VARIATION	—	0	123	4
HARPSICHORD	HARPSICHORD 1	0	122	6
VARIATION	HARPSICHORD 2	0	123	6
E. CLAVICHORD	—	0	122	7
VARIATION	—	0	123	7
VIBRAPHONE	VIBRAPHONE	0	122	11
VARIATION	—	0	122	12
CHURCH ORGAN	CHURCH ORGAN 1	0	123	19
VARIATION	CHURCH ORGAN 2	0	122	19
JAZZ ORGAN	JAZZ ORGAN	0	122	16
VARIATION	—	0	123	16
STRINGS	STRINGS 1	0	122	48
VARIATION	STRINGS 2	0	122	49
CHOIR	CHOIR	0	122	52
VARIATION	—	0	123	52
GUITAR	GUITAR	0	122	24
VARIATION	—	0	122	25
WOOD BASS	—	0	122	32
VARIATION	—	0	124	32
E.BASS	—	0	122	33
VARIATION	—	0	122	35

- When program change reception is turned OFF in the Function mode, no program change data is transmitted or received. Also, Bank MSB/LSB is not transmitted or received.

#### 5. SYSTEM REALTIME MESSAGES

[rrH]

F8H: Timing clock

FAH: Start

FCH: Stop

FEH: Active sensing

Data	Transmission	Reception
F8H	Transmitted every 96 clocks	Received as 96-clock tempo timing when MIDI clock is set to External
FAH	Recorder start	Recorder start Not received when the MIDI clock is set to Internal.
FCH	Recorder stop	Recorder stop Not received when the MIDI clock is set to Internal.
FEH	Transmitted every 200 milliseconds	If a signal is not received via MIDI for more than 400 milliseconds, the same processing will take place for All Sound Off, All Notes Off and Reset All Controllers as when those signals are received.

- Caution: If an error occurs during MIDI reception, the Damper, Sostenuato, and Soft effects for all channels are turned off and an All Note Off occurs.

#### 6. SYSTEM EXCLUSIVE MESSAGES

##### (Yamaha MIDI Format)

##### Panel Data Transmit

Data format: [F0H] -> [43H] -> [0nH] -> [7CH] -> ... -> [F7H]

F0H, 43H, 0nH, 7CH (n: channel number)

00H, LLH (data length)

43H, 4CH, 20H, 20H (CL)

43H, 4CH, 50H, 27H, 30H, 35H (CLP05)

3xH, 3yH

aaH, bbH: Device No. aa=LSB, bb=MSB

aa=5EH, bb=16H (CLP-240)

aa=5BH, bb=16H (CLP-230)

[PANEL DATA]

[CHECK SUM (1byte)] = 0-(43H+4CH+20H+.....+Data end)

F7H

##### • Panel Data Contents

- |                                |                               |
|--------------------------------|-------------------------------|
| (1) 1'st Voice                 | (19) Reverb Type 1            |
| (2) Dual On/Off                | (20) Reverb Type 2            |
| (3) Dual Voice                 | (21) Reverb Depth 1           |
| (4) Dual Balance               | (22) Reverb Depth 2           |
| (5) Dual Detune                | (23) Effect Type 1            |
| (6) Dual Voice1 Octave         | (24) Effect Type 2            |
| (7) Dual Voice2 Octave         | (25) Effect Depth             |
| (8) Dual Voice1 Effect Depth   | (26) Variation On/Off         |
| (9) Dual Voice2 Effect Depth   | (27) Touch Sensitivity        |
| (10) Split On/Off              | (28) Fixed Data               |
| (11) Split Voice               | (29) Left Pedal               |
| (12) Split Point               | (30) Soft Pedal Depth         |
| (13) Split Balance             | (31) Absolute tempo low byte  |
| (14) Split Voice1 Octave       | (32) Absolute tempo high byte |
| (15) Split Voice2 Octave       | (33) Key-Off Sampling Depth   |
| (16) Split Voice1 Effect Depth | (34) DDE On/Off               |
| (17) Split Voice2 Effect Depth | (35) DDE Depth                |
| (18) Split Dumper Mode         | (36) Brilliance               |

- Panel data send requests cannot be received.

#### 7. SYSTEM EXCLUSIVE MESSAGES

##### (Universal System Exclusive)

##### (1) Universal Realtime Message

Data format: [F0H] -> [7FH] -> [XnH] -> [04H] -> [01H] ->

[lIH] -> [mmH] -> [F7H]

##### MIDI Master Volume

- Simultaneously changes the volume of all channels.
- When a MIDI master volume message is received, the volume only has affect on the MIDI receive channel, not the panel master volume.

F0H = Exclusive status

7FH = Universal Realtime

7FH = ID of target device

04H = Sub-ID #1=Device Control Message

01H = Sub-ID #2=Master Volume

l/H = Volume LSB

mmH = Volume MSB

F7H = End of Exclusive

or

F0H = Exclusive status

7FH = Universal Realtime

XnH = When n is received n=0~F, whichever is received.

X = don't care

04H = Sub-ID #1=Device Control Message

01H = Sub-ID #2=Master Volume

l/H = Volume LSB

mmH = Volume MSB

F7H = End of Exclusive

## (2) Universal Non-Realtime Message (GM On)

### General MIDI Mode On

Data format: [F0H] -> [7EH] -> [XnH] -> [09H] -> [01H] -> [F7H]

F0H = Exclusive status  
7EH = Universal Non-Realtime  
7FH = ID of target device  
09H = Sub-ID #1=General MIDI Message  
01H = Sub-ID #2=General MIDI On  
F7H = End of Exclusive

or

F0H = Exclusive status  
7EH = Universal Non-Realtime  
XnH = When received, n=0~F.  
X = don't care  
09H = Sub-ID #1=General MIDI Message  
01H = Sub-ID #2=General MIDI On  
F7H = End of Exclusive

When the General MIDI mode ON message is received, the MIDI system will be reset to its default settings.

This message requires approximately 50ms to execute, so sufficient time should be allowed before the next message is sent.

## 8. SYSTEM EXCLUSIVE MESSAGES (XG Standard)

### (1) XG Native Parameter Change

Data format: [F0H] -> [43H] -> [1nH] -> [4CH] -> [hhH] -> [mmH] -> [l/H] -> [ddH] -> [F7H]

F0H = Exclusive status  
43H = YAMAHA ID  
1nH = When received, n=0~F.  
When transmitted, n=0.  
4CH = Model ID of XG  
hhH = Address High  
mmH = Address Mid  
l/H = Address Low  
ddH = Data

|  
F7H = End of Exclusive

Data size must match parameter size (2 or 4 bytes).

When the XG System On message is received, the MIDI system will be reset to its default settings.

The message requires approximately 50ms to execute, so sufficient time should be allowed before the next message is sent.

### (2) XG Native Bulk Data (reception only)

Data format: [F0H] -> [43H] -> [0nH] -> [4CH] -> [aaH] -> [bbH] -> [hhH] -> [mmH] -> [l/H] -> [ddH] -> ...-> [ccH] -> [F7H]

F0H = Exclusive status  
43H = YAMAHA ID  
0nH = When received, n=0~F.  
When transmitted, n=0.  
4CH = Model ID of XG  
aaH = ByteCount  
bbH = ByteCount  
hhH = Address High  
mmH = Address Mid  
l/H = Address Low  
ddH = Data

| |  
| |  
ccH = Check sum

F7H = End of Exclusive

- Receipt of the XG SYSTEM ON message causes reinitialization of relevant parameters and Control Change values. Allow sufficient time for processing to execute (about 50 msec) before sending the CLP-240/230 another message.
- XG Native Parameter Change message may contain two or four bytes of parameter data (depending on the parameter size).
- For information about the Address and Byte Count values, refer to Table 1 below. Note that the table's Total Size value gives the size of a bulk block. Only the top address of the block (00H, 00H, 00H) is valid as a bulk data address.

## 9. SYSTEM EXCLUSIVE MESSAGES (Clavinova MIDI Format)

Data format: [F0H] -> [43H] -> [73H] -> [01H] -> [nnH] -> [F7H]

F0H = Exclusive status  
43H = Yamaha ID  
73H = Clavinova ID  
01H = Product ID (CLP common)  
nnH = Substatus  
nn Control  
02H Internal MIDI clock  
03H External MIDI clock  
F7H = End of Exclusive

## 10. SYSTEM EXCLUSIVE MESSAGES (Special Control)

Data format: [F0H] -> [43H] -> [73H] -> [66H] -> [11H] -> [0nH] -> [ccH] -> [vvH] -> [F7H]

F0H = Exclusive status  
43H = Yamaha ID  
73H = Clavinova ID  
7FH = Extended Product ID  
xxH = Product ID 49H  
11H = Special control  
0nH = Control MIDI change (n=channel number)  
cc = Control number  
vv = Value  
F7H = End of Exclusive

Control	0n	ccH	vvH
Split Point	Always 00H	14H	14H: Split Key Number
Metronome	Always 00H	1BH	00H: No accent 01H-0FH: 1/4-15/4 7FH: off
Damper Level	ch: 00H-0FH	3DH	(Sets the Damper Level for each channel) 00H-7FH
Channel Detune	ch: 00H-0FH	43H	(Sets the Detune value for each channel) 00H-7FH
Voice Reserve	ch: 00H-0FH	45H	00H: Reserve off 7FH: on*

\* When Volume, Expression is received for Reserve On, they will be effective from the next Key On. Reserve Off is normal.

## 11. SYSTEM EXCLUSIVE MESSAGES (Others)

Data format: [F0H] -> [43H] -> [1nH] -> [27H] -> [30H] -> [00H] -> [00H] -> [mmH] -> [l/H] -> [ccH] -> [F7H]

Master Tuning (XG and last message priority) simultaneously changes the pitch of all channels.

F0H = Exclusive Status  
43H = Yamaha ID  
1nH = When received, n=0~F.  
When transmitted, n=0.  
27H = Model ID of TG100  
30H = Sub ID  
00H =  
00H =  
mmH = Master Tune MSB  
l/H = Master Tune LSB  
ccH = don't care (under 7FH)  
F7H = End of Exclusive

<Table 1>

**MIDI Parameter Change table (SYSTEM)**

Address (H)	Size (H)	Data (H)	Parameter	Description	Default value (H)
00 00 00	4	020C - 05F4*	MASTER TUNE	-50 - +50[cent]	00 04 00 00
01				1st bit 3 - 0 → bit 15 - 12	400
02				2nd bit 3 - 0 → bit 11 - 8	
03				3rd bit 3 - 0 → bit 7 - 4	
				4th bit 3 - 0 → bit 3 - 0	
04	1	00 - 7F	MASTER VOLUME	0 - 127	7F
05	1	—	—		
7E		00	XG SYSTEM ON	00=XG system ON	
7F		00	RESET ALL PARAMETERS	00=ON (receive only)	
TOTAL SIZE 07					

\*Values lower than 020CH select -50 cents. Values higher than 05F4H select +50 cents.

<Table 2>

**MIDI Parameter Change table (EFFECT 1)**

Refer to the "Effect MIDI Map" for a complete list of Reverb, Chorus and Variation type numbers.

Address (H)	Size (H)	Data (H)	Parameter	Description	Default value (H)
02 01 00	2	00-7F	REVERB TYPE MSB	Refer to Effect MIDI Map	01 (=HALL1)
		00-7F	REVERB TYPE LSB	00 : basic type	00
02 01 40	2	00-7F	VARIATION TYPE MSB	Refer to Effect MIDI Map	00(=Effect off)
		00-7F	VARIATION TYPE LSB	00 : basic type	00

• "VARIATION" refers to the EFFECT on the panel.

<Table 3>

**MIDI Parameter Change table (MULTI PART)**

Address (H)	Size (H)	Data (H)	Parameter	Description	Default value (H)
08 nn 11	1	00 - 7F	DRY LEVEL	0 - 127	7F
nn = Part Number					

• **Effect MIDI Map**

**REVERB**

	MSB	LSB
ROOM	02H	10H
HALL 1	01H	10H
HALL 2	01H	11H
STAGE	03H	10H
OFF	00H	00H

**EFFECT**

	MSB	LSB
CHORUS	42H	10H
PHASER	48H	10H
TREMOLO	46H	10H
ROTARY SP	47H	10H
OFF	00H	00H

Function...	Transmitted	Recognized	Remarks
Basic Channel Default Changed	1 - 16 X	1 - 16 1 - 16	
Mode Default Messages Altered	3 X *****	3 X X	
Note Number : True voice	0 - 127 *****	0 - 127 0 - 127	
Velocity Note ON Note OFF	O 9nH,v=1-127 X 9nH,v=0	O 9nH,v=1-127 X 9nH,v=0 or 8nH	
After Touch Key's Ch's	X X	X X	
Pitch Bend	X *1	X 0 - 24 semi	
Control Change 0,32 1 7 10 11 6,38 64,66,67 84 91,94 96-97 100-101	O X *1 X *1 X *1 O X *1 O X *1 O X *1 X *1	O O O O O O O O O O	Bank Select Modulation Main Volume Panpot Expression Data Entry  Portamento Control Effect Depth RPN Inc,Dec RPN LSB,MSB
Prog Change : True #	O 0 - 127 *****	O 0 - 127	
System Exclusive	O	O	
Common : Song Pos. : Song Sel. : Tune	X X X	X X X	
System : Clock Real Time : Commands	O O	O O	
Aux : All Sound Off : Reset All Cntrls : Local ON/OFF Mes- : All Notes OFF sages: Active Sense : Reset	O O X O O X	O (120,126,127) O (121) O (122) O (123-125) O X	
Notes: *1= These Control Change messages cannot be transmitted by panel operations, but can be transmitted by song playback data.			

Mode 1 : OMNI ON , POLY      Mode 2 : OMNI ON , MONO      O : Yes  
 Mode 3 : OMNI OFF, POLY      Mode 4 : OMNI OFF, MONO      X : No

# Specifications / Technische Daten / Caractéristiques techniques / Especificaciones

	CLP-240	CLP-230
Keyboard	GH3 keyboard 88 keys (A-1 – C7)	
Sound Source	AWM Dynamic Stereo Sampling	AWM Stereo Sampling
Polyphony (Max.)	64	
Voice Selection	14 × 2 variations for each voice	14
Effect	Reverb, Effect, Brilliance, DDE (Dynamic Damper Effect)	Reverb, Effect, Brilliance
Volume	Master Volume	
Controls	Dual, Split, Metronome, Transpose, Touch (Hard/Medium/Soft/Fixed), Functions, Speaker ON/OFF	Dual, Metronome, Transpose, Touch (Hard/Medium/Soft/Fixed), Functions, Speaker ON/OFF
Recording/Playback	2-part recording/playback (three user songs), Tempo Adjustment, Sync Start	
Pedal	Damper (with half-pedal effect), Sostenuto, Soft	
Demo Songs	14 voice Demo Songs, 50 preset Songs	
Jacks/Connectors	MIDI (IN/OUT/THRU), PHONES × 2, AUX IN (L/L+R, R), AUX OUT (LEVEL FIXED) (L, R), USB TO HOST, USB TO DEVICE	MIDI (IN/OUT/THRU), PHONES × 2, AUX IN (L/L+R, R), AUX OUT (LEVEL FIXED) (L, R), USB TO HOST
Memory Device	Optional USB storage device (via USB TO DEVICE terminal)	—
	Internal Flash Memory (for saving User songs): 65 KB (for saving External songs): 307 KB	
Main Amplifiers	40W × 2	20W × 2
Speakers	16cm × 2, 5cm × 2	16cm × 2
Dimensions (W × D × H) (with music rest)	1,413mm × 507mm × 897mm [55 5/8" × 19 15/16" × 35 5/16"] (1,413mm × 507mm × 1,010mm) [55 5/8" × 19 15/16" × 39 3/4"]	
Weight	68kg (149lbs., 15oz)	65kg (143lbs., 5oz)
Accessories	Owner's Manual, "50 greats for the Piano" (Music Book), Accessory CD-ROM for Windows, Accessory CD-ROM for Windows Installation Guide, Bench (included or optional depending on locale)	

- \* Specifications and descriptions in this owner's manual are for information purposes only. Yamaha Corp. reserves the right to change or modify products or specifications at any time without prior notice. Since specifications, equipment or options may not be the same in every locale, please check with your Yamaha dealer.
- \* Die technischen Daten und Beschreibungen in dieser Bedienungsanleitung dienen nur der Information. Yamaha Corp. behält sich das Recht vor, Produkte oder deren technische Daten jederzeit ohne vorherige Ankündigung zu verändern oder zu modifizieren. Da die technischen Daten, das Gerät selbst oder Sonderzubehör nicht in jedem Land gleich sind, setzen Sie sich im Zweifel bitte mit Ihrem Yamaha-Händler in Verbindung.
- \* Les caractéristiques techniques et les descriptions du mode d'emploi ne sont données que pour information. Yamaha Corp. se réserve le droit de changer ou modifier les produits et leurs caractéristiques techniques à tout moment sans aucun avis. Du fait que les caractéristiques techniques, les équipements et les options peuvent différer d'un pays à l'autre, adressez-vous au distributeur Yamaha le plus proche.
- \* Las especificaciones y descripciones de este manual del propietario tienen sólo el propósito de servir como información. Yamaha Corp. se reserva el derecho a efectuar cambios o modificaciones en los productos o especificaciones en cualquier momento sin previo aviso. Puesto que las especificaciones, equipos u opciones pueden no ser las mismas en todos los mercados, solicite información a su distribuidor Yamaha.

# IMPORTANT SAFETY INSTRUCTIONS

## INFORMATION RELATING TO PERSONAL INJURY, ELECTRICAL SHOCK, AND FIRE HAZARD POSSIBILITIES HAS BEEN INCLUDED IN THIS LIST.

**WARNING-** When using any electrical or electronic product, basic precautions should always be followed. These precautions include, but are not limited to, the following:

- 1.** Read all Safety Instructions, Installation Instructions, Special Message Section items, and any Assembly Instructions found in this manual **BEFORE** making any connections, including connection to the main supply.
- 2.** Main Power Supply Verification: Yamaha products are manufactured specifically for the supply voltage in the area where they are to be sold. If you should move, or if any doubt exists about the supply voltage in your area, please contact your dealer for supply voltage verification and (if applicable) instructions. The required supply voltage is printed on the name plate. For name plate location, please refer to the graphic found in the Special Message Section of this manual.
- 3.** This product may be equipped with a polarized plug (one blade wider than the other). If you are unable to insert the plug into the outlet, turn the plug over and try again. If the problem persists, contact an electrician to have the obsolete outlet replaced. Do **NOT** defeat the safety purpose of the plug.
- 4.** Some electronic products utilize external power supplies or adapters. Do **NOT** connect this type of product to any power supply or adapter other than one described in the owners manual, on the name plate, or specifically recommended by Yamaha.
- 5.** **WARNING:** Do not place this product or any other objects on the power cord or place it in a position where anyone could walk on, trip over, or roll anything over power or connecting cords of any kind. The use of an extension cord is not recommended! If you must use an extension cord, the minimum wire size for a 25' cord (or less) is 18 AWG. **NOTE:** The smaller the AWG number, the larger the current handling capacity. For longer extension cords, consult a local electrician.
- 6.** Ventilation: Electronic products, unless specifically designed for enclosed installations, should be placed in locations that do not interfere with proper ventilation. If instructions for enclosed installations are not provided, it must be assumed that unobstructed ventilation is required.
- 7.** Temperature considerations: Electronic products should be installed in locations that do not significantly contribute to their operating temperature. Placement of this product close to heat sources such as; radiators, heat registers and other devices that produce heat should be avoided.
- 8.** This product was **NOT** designed for use in wet/damp locations and should not be used near water or exposed to rain. Examples of wet/damp locations are; near a swimming pool, spa, tub, sink, or wet basement.
- 9.** This product should be used only with the components supplied or; a cart, rack, or stand that is recommended by the manufacturer. If a cart, rack, or stand is used, please observe all safety markings and instructions that accompany the accessory product.
- 10.** The power supply cord (plug) should be disconnected from the outlet when electronic products are to be left unused for extended periods of time. Cords should also be disconnected when there is a high probability of lightning and/or electrical storm activity.
- 11.** Care should be taken that objects do not fall and liquids are not spilled into the enclosure through any openings that may exist.
- 12.** Electrical/electronic products should be serviced by a qualified service person when:
  - a. The power supply cord has been damaged; or
  - b. Objects have fallen, been inserted, or liquids have been spilled into the enclosure through openings; or
  - c. The product has been exposed to rain; or
  - d. The product does not operate, exhibits a marked change in performance; or
  - e. The product has been dropped, or the enclosure of the product has been damaged.
- 13.** Do not attempt to service this product beyond that described in the user-maintenance instructions. All other servicing should be referred to qualified service personnel.
- 14.** This product, either alone or in combination with an amplifier and headphones or speaker/s, may be capable of producing sound levels that could cause permanent hearing loss. **DO NOT** operate for a long period of time at a high volume level or at a level that is uncomfortable. If you experience any hearing loss or ringing in the ears, you should consult an audiologist. **IMPORTANT:** The louder the sound, the shorter the time period before damage occurs.
- 15.** Some Yamaha products may have benches and/or accessory mounting fixtures that are either supplied as a part of the product or as optional accessories. Some of these items are designed to be dealer assembled or installed. Please make sure that benches are stable and any optional fixtures (where applicable) are well secured **BEFORE** using. Benches supplied by Yamaha are designed for seating only. No other uses are recommended.

## PLEASE KEEP THIS MANUAL



# FCC INFORMATION (U.S.A.)

## 1. IMPORTANT NOTICE: DO NOT MODIFY THIS UNIT!

This product, when installed as indicated in the instructions contained in this manual, meets FCC requirements. Modifications not expressly approved by Yamaha may void your authority, granted by the FCC, to use the product.

2. **IMPORTANT:** When connecting this product to accessories and/or another product use only high quality shielded cables. Cable/s supplied with this product MUST be used. Follow all installation instructions. Failure to follow instructions could void your FCC authorization to use this product in the USA.
3. **NOTE:** This product has been tested and found to comply with the requirements listed in FCC Regulations, Part 15 for Class "B" digital devices. Compliance with these requirements provides a reasonable level of assurance that your use of this product in a residential environment will not result in harmful interference with other electronic devices. This equipment generates/uses radio frequencies and, if not installed and used according to the instructions found in the users manual, may cause interference harmful to the operation of

other electronic devices. Compliance with FCC regulations does not guarantee that interference will not occur in all installations. If this product is found to be the source of interference, which can be determined by turning the unit "OFF" and "ON", please try to eliminate the problem by using one of the following measures:

Relocate either this product or the device that is being affected by the interference.

Utilize power outlets that are on different branch (circuit breaker or fuse) circuits or install AC line filter/s.

In the case of radio or TV interference, relocate/reorient the antenna. If the antenna lead-in is 300 ohm ribbon lead, change the lead-in to co-axial type cable.

If these corrective measures do not produce satisfactory results, please contact the local retailer authorized to distribute this type of product. If you can not locate the appropriate retailer, please contact Yamaha Corporation of America, Electronic Service Division, 6600 Orangethorpe Ave, Buena Park, CA90620

The above statements apply ONLY to those products distributed by Yamaha Corporation of America or its subsidiaries.

\* This applies only to products distributed by YAMAHA CORPORATION OF AMERICA.

(class B)

## IMPORTANT NOTICE FOR THE UNITED KINGDOM

### Connecting the Plug and Cord

IMPORTANT. The wires in this mains lead are coloured in accordance with the following code:

BLUE : NEUTRAL  
BROWN : LIVE

As the colours of the wires in the mains lead of this apparatus may not correspond with the coloured markings identifying the terminals in your plug proceed as follows:

The wire which is coloured BLUE must be connected to the terminal which is marked with the letter N or coloured BLACK.

The wire which is coloured BROWN must be connected to the terminal which is marked with the letter L or coloured RED.

Making sure that neither core is connected to the earth terminal of the three pin plug.

(2 wires)

- This applies only to products distributed by Yamaha-Kemble Music (U.K.) Ltd.

## COMPLIANCE INFORMATION STATEMENT (DECLARATION OF CONFORMITY PROCEDURE)

Responsible Party : Yamaha Corporation of America  
Address : 6600 Orangethorpe Ave., Buena Park,  
Calif. 90620  
Telephone : 714-522-9011  
Type of Equipment : Electronic Piano  
Model Name : CLP-240/230

This device complies with Part 15 of the FCC Rules.

Operation is subject to the following conditions:

- 1) this device may not cause harmful interference, and
- 2) this device must accept any interference received including interference that may cause undesired operation.

See user manual instructions if interference to radio reception is suspected.

\* This applies only to products distributed by  
YAMAHA CORPORATION OF AMERICA.

(FCC DoC)

**CAUTION:** TO PREVENT ELECTRIC SHOCK, MATCH WIDE BLADE OF PLUG TO WIDE SLOT, FULLY INSERT.

**ATTENTION:** POUR ÉVITER LES CHOCS ÉLECTRIQUES, INTRODUIRE LA LAME LA PLUS LARGE DE LA FICHE DANS LA BORNE CORRESPONDANTE DE LA PRISE ET POUSSER JUSQU' AU FOND.

(polarity)

- This applies only to products distributed by Yamaha Canada Music Ltd.
- Ceci ne s'applique qu'aux produits distribués par Yamaha Canada Musique Ltée.

**MEMO**



For details of products, please contact your nearest Yamaha representative or the authorized distributor listed below.

Pour plus de détails sur les produits, veuillez-vous adresser à Yamaha ou au distributeur le plus proche de vous figurant dans la liste suivante.

Die Einzelheiten zu Produkten sind bei Ihrer unten aufgeführten Niederlassung und bei Yamaha Vertragshändlern in den jeweiligen Bestimmungsländern erhältlich.

Para detalles sobre productos, contacte su tienda Yamaha más cercana o el distribuidor autorizado que se lista debajo.

## NORTH AMERICA

### CANADA

**Yamaha Canada Music Ltd.**  
135 Milner Avenue, Scarborough, Ontario,  
M1S 3R1, Canada  
Tel: 416-298-1311

### U.S.A.

**Yamaha Corporation of America**  
6600 Orangethorpe Ave., Buena Park, Calif. 90620,  
U.S.A.  
Tel: 714-522-9011

## CENTRAL & SOUTH AMERICA

### MEXICO

**Yamaha de México S.A. de C.V.**  
Calz. Javier Rojo Gómez #1149,  
Col. Guadalupe del Moral  
C.P. 09300, México, D.F., México  
Tel: 55-5804-0600

### BRAZIL

**Yamaha Musical do Brasil Ltda.**  
Rua Joaquim Floriano, 913 - 4º andar, Itaim Bibi,  
CEP 04534-013 Sao Paulo, SP. BRAZIL  
Tel: 011-3704-1377

### ARGENTINA

**Yamaha Music Latin America, S.A.**  
**Sucursal de Argentina**  
Viamonte 1145 Piso2-B 1053,  
Buenos Aires, Argentina  
Tel: 1-4371-7021

### PANAMA AND OTHER LATIN AMERICAN COUNTRIES/ CARIBBEAN COUNTRIES

**Yamaha Music Latin America, S.A.**  
Torre Banco General, Piso 7, Urbanización Marbella,  
Calle 47 y Aquilino de la Guardia,  
Ciudad de Panamá, Panamá  
Tel: +507-269-5311

## EUROPE

### THE UNITED KINGDOM

**Yamaha-Kemble Music (U.K.) Ltd.**  
Sherbourne Drive, Tilbrook, Milton Keynes,  
MK7 8BL, England  
Tel: 01908-366700

### IRELAND

**Danfay Ltd.**  
61D, Sallynoggin Road, Dun Laoghaire, Co. Dublin  
Tel: 01-2859177

### GERMANY

**Yamaha Music Central Europe GmbH**  
Siemensstraße 22-34, 25462 Rellingen, Germany  
Tel: 04101-3030

### SWITZERLAND/LIECHTENSTEIN

**Yamaha Music Central Europe GmbH,  
Branch Switzerland**  
Seefeldstrasse 94, 8008 Zürich, Switzerland  
Tel: 01-383 3990

### AUSTRIA

**Yamaha Music Central Europe GmbH,  
Branch Austria**  
Schleiergasse 20, A-1100 Wien, Austria  
Tel: 01-60203900

### CZECH REPUBLIC/SLOVAKIA/ HUNGARY/SLOVENIA

**Yamaha Music Central Europe GmbH,  
Branch Austria, CEE Department**  
Schleiergasse 20, A-1100 Wien, Austria  
Tel: 01-602039025

### POLAND

**Yamaha Music Central Europe GmbH  
Sp.z o.o. Oddział w Polsce**  
ul. 17 Stycznia 56, PL-02-146 Warszawa, Poland  
Tel: 022-868-07-57

### THE NETHERLANDS/ BELGIUM/LUXEMBOURG

**Yamaha Music Central Europe GmbH,  
Branch Benelux**  
Clarissenhof 5-b, 4133 AB Vianen, The Netherlands  
Tel: 0347-358 040

### FRANCE

**Yamaha Musique France**  
BP 70-77312 Marne-la-Vallée Cedex 2, France  
Tel: 01-64-61-4000

### ITALY

**Yamaha Musica Italia S.P.A.**  
Viale Italia 88, 20020 Lainate (Milano), Italy  
Tel: 02-935-771

### SPAIN/PORTUGAL

**Yamaha-Hazen Música, S.A.**  
Ctra. de la Corona km. 17, 200, 28230  
Las Rozas (Madrid), Spain  
Tel: 91-639-8888

### GREECE

**Philippos Nakas S.A. The Music House**  
147 Skiathou Street, 112-55 Athens, Greece  
Tel: 01-228 2160

### SWEDEN

**Yamaha Scandinavia AB**  
J. A. Wettergrens Gata 1  
Box 30053  
S-400 43 Göteborg, Sweden  
Tel: 031 89 34 00

### DENMARK

**YS Copenhagen Liaison Office**  
Generatorvej 6A  
DK-2730 Herlev, Denmark  
Tel: 44 92 49 00

### FINLAND

**F-Musiikki Oy**  
Kluuvikatu 6, P.O. Box 260,  
SF-00101 Helsinki, Finland  
Tel: 09 618511

### NORWAY

**Norsk filial av Yamaha Scandinavia AB**  
Grini Næringspark 1  
N-1345 Østerås, Norway  
Tel: 67 16 77 70

### ICELAND

**Skifan HF**  
Skeifan 17 P.O. Box 8120  
IS-128 Reykjavik, Iceland  
Tel: 525 5000

### OTHER EUROPEAN COUNTRIES

**Yamaha Music Central Europe GmbH**  
Siemensstraße 22-34, 25462 Rellingen, Germany  
Tel: +49-4101-3030

## AFRICA

**Yamaha Corporation,  
Asia-Pacific Music Marketing Group**  
Nakazawa-cho 10-1, Hamamatsu, Japan 430-8650  
Tel: +81-53-460-2312

## MIDDLE EAST

### TURKEY/CYPRUS

**Yamaha Music Central Europe GmbH**  
Siemensstraße 22-34, 25462 Rellingen, Germany  
Tel: 04101-3030

### OTHER COUNTRIES

**Yamaha Music Gulf FZE**  
LB21-128 Jebel Ali Freezone  
P.O.Box 17328, Dubai, U.A.E.  
Tel: +971-4-881-5868

## ASIA

### THE PEOPLE'S REPUBLIC OF CHINA

**Yamaha Music & Electronics (China) Co.,Ltd.**  
25/F., United Plaza, 1468 Nanjing Road (West),  
Jingan, Shanghai, China  
Tel: 021-6247-2211

### HONG KONG

**Tom Lee Music Co., Ltd.**  
11/F., Silvercord Tower 1, 30 Canton Road,  
Tsimshatsui, Kowloon, Hong Kong  
Tel: 2737-7688

### INDONESIA

**PT. Yamaha Music Indonesia (Distributor)  
PT. Nusantik**  
Gedung Yamaha Music Center, Jalan Jend. Gatot  
Subroto Kav. 4, Jakarta 12930, Indonesia  
Tel: 21-520-2577

### KOREA

**Yamaha Music Korea Ltd.**  
Tong-Yang Securities Bldg. 16F 23-8 Yoido-dong,  
Youngdungpo-ku, Seoul, Korea  
Tel: 02-3770-0660

### MALAYSIA

**Yamaha Music Malaysia, Sdn., Bhd.**  
Lot 8, Jalan Perbandaran, 47301 Kelana Jaya,  
Petaling Jaya, Selangor, Malaysia  
Tel: 3-78030900

### PHILIPPINES

**Yupangco Music Corporation**  
339 Gil J. Puyat Avenue, P.O. Box 885 MCPO,  
Makati, Metro Manila, Philippines  
Tel: 819-7551

### SINGAPORE

**Yamaha Music Asia Pte., Ltd.**  
#03-11 A-Z Building  
140 Paya Lebar Road, Singapore 409015  
Tel: 747-4374

### TAIWAN

**Yamaha KHS Music Co., Ltd.**  
3F, #6, Sec.2, Nan Jing E. Rd. Taipei.  
Taiwan 104, R.O.C.  
Tel: 02-2511-8688

### THAILAND

**Siam Music Yamaha Co., Ltd.**  
891/1 Siam Motors Building, 15-16 floor  
Rama 1 road, Wangmai, Pathumwan  
Bangkok 10330, Thailand  
Tel: 02-215-2626

### OTHER ASIAN COUNTRIES

**Yamaha Corporation,  
Asia-Pacific Music Marketing Group**  
Nakazawa-cho 10-1, Hamamatsu, Japan 430-8650  
Tel: +81-53-460-2317

## OCEANIA

### AUSTRALIA

**Yamaha Music Australia Pty. Ltd.**  
Level 1, 99 Queensbridge Street, Southbank,  
Victoria 3006, Australia  
Tel: 3-9693-5111

### NEW ZEALAND

**Music Houses of N.Z. Ltd.**  
146/148 Captain Springs Road, Te Papapa,  
Auckland, New Zealand  
Tel: 9-634-0099

### COUNTRIES AND TRUST TERRITORIES IN PACIFIC OCEAN

**Yamaha Corporation,  
Asia-Pacific Music Marketing Group**  
Nakazawa-cho 10-1, Hamamatsu, Japan 430-8650  
Tel: +81-53-460-2312

**HEAD OFFICE** Yamaha Corporation, Pro Audio & Digital Musical Instrument Division  
Nakazawa-cho 10-1, Hamamatsu, Japan 430-8650  
Tel: +81-53-460-3273



**Clavinova Web site**

<http://music.yamaha.com/homekeyboard>

**Yamaha Manual Library**

<http://www.yamaha.co.jp/manual/>