

Clavinova®

CLP-295GP OWNER'S MANUAL

Before using the Clavinova, be sure to read "PRECAUTIONS," on pages 3-4.

IMPORTANT

—Check your power supply—

Make sure that your local AC mains voltage matches the voltage specified on the name plate on the bottom panel. In some areas a voltage selector may be provided on the bottom panel of the main keyboard unit near the power cord. Make sure that the voltage selector is set for the voltage in your area. The voltage selector is set at 240V when the unit is initially shipped. To change the setting use a "minus" screwdriver to rotate the selector dial so that the correct voltage appears next to the pointer on the panel.

For information on assembling the keyboard stand, refer to the instructions at the end of this manual.

SPECIAL MESSAGE SECTION

PRODUCT SAFETY MARKINGS: Yamaha electronic products may have either labels similar to the graphics shown below or molded/stamped facsimiles of these graphics on the enclosure. The explanation of these graphics appears on this page. Please observe all cautions indicated on this page and those indicated in the safety instruction section.

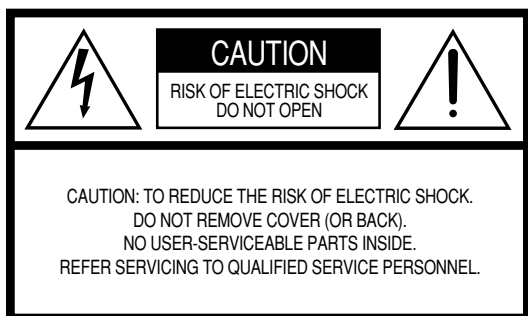

See bottom of Keyboard enclosure for graphic symbol markings



The exclamation point within the equilateral triangle is intended to alert the user to the presence of important operating and maintenance (servicing) instructions in the literature accompanying the product.

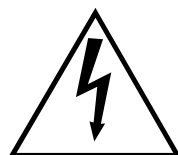

The lightning flash with arrowhead symbol, within the equilateral triangle, is intended to alert the user to the presence of uninsulated “dangerous voltage” within the product’s enclosure that may be of sufficient magnitude to constitute a risk of electrical shock.

IMPORTANT NOTICE: All Yamaha electronic products are tested and approved by an independent safety testing laboratory in order that you may be sure that when it is properly installed and used in its normal and customary manner, all foreseeable risks have been eliminated. DO NOT modify this unit or commission others to do so unless specifically authorized by Yamaha. Product performance and/or safety standards may be diminished. Claims filed under the expressed warranty may be denied if the unit is/has been modified. Implied warranties may also be affected.

SPECIFICATIONS SUBJECT TO CHANGE: The information contained in this manual is believed to be correct at the time of printing. However, Yamaha reserves the right to change or modify any of the specifications without notice or obligation to update existing units.

ENVIRONMENTAL ISSUES: Yamaha strives to produce products that are both user safe and environmentally friendly. We sincerely believe that our products and the production methods used to produce them, meet these goals. In keeping with both the letter and the spirit of the law, we want you to be aware of the following:

Battery Notice: This product MAY contain a small non-rechargeable battery which (if applicable) is soldered in place. The average life span of this type of battery is approximately five years. When replacement becomes necessary, contact a qualified service representative to perform the replacement.

Warning: Do not attempt to recharge, disassemble, or incinerate this type of battery. Keep all batteries away from children. Dispose of used batteries promptly and as regulated by applicable laws. Note: In some areas, the servicer is required by law to return the defective parts. However, you do have the option of having the servicer dispose of these parts for you.

Disposal Notice: Should this product become damaged beyond repair, or for some reason its useful life is considered to be at an end, please observe all local, state, and federal regulations that relate to the disposal of products that contain lead, batteries, plastics, etc.

NOTICE: Service charges incurred due to lack of knowledge relating to how a function or effect works (when the unit is operating as designed) are not covered by the manufacturer’s warranty, and are therefore the owners responsibility. Please study this manual carefully and consult your dealer before requesting service.

NAME PLATE LOCATION: The graphic below indicates the location of the name plate. The model number, serial number, power requirements, etc., are located on this plate. You should record the model number, serial number, and the date of purchase in the spaces provided below and retain this manual as a permanent record of your purchase.

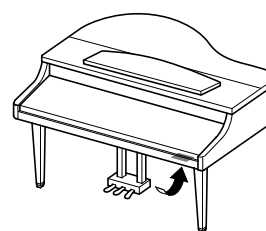

CLP-295GP

Model _____

Serial No. _____

Purchase Date _____

PRECAUTIONS

PLEASE READ CAREFULLY BEFORE PROCEEDING

* Please keep this manual in a safe place for future reference.



WARNING

Always follow the basic precautions listed below to avoid the possibility of serious injury or even death from electrical shock, short-circuiting, damages, fire or other hazards. These precautions include, but are not limited to, the following:

Power supply/Power cord

- Only use the voltage specified as correct for the instrument. The required voltage is printed on the name plate of the instrument.
- Check the electric plug periodically and remove any dirt or dust which may have accumulated on it.
- Use only the supplied power cord/plug.
- Do not place the power cord near heat sources such as heaters or radiators, and do not excessively bend or otherwise damage the cord, place heavy objects on it, or place it in a position where anyone could walk on, trip over, or roll anything over it.

Do not open

- Do not open the instrument or attempt to disassemble the internal parts or modify them in any way. The instrument contains no user-serviceable parts. If it should appear to be malfunctioning, discontinue use immediately and have it inspected by qualified Yamaha service personnel.

Water warning

- Do not expose the instrument to rain, use it near water or in damp or wet conditions, or place containers on it containing liquids which might spill into any openings.
- Never insert or remove an electric plug with wet hands.

Fire warning

- Do not put burning items, such as candles, on the unit. A burning item may fall over and cause a fire.

If you notice any abnormality

- If the power cord or plug becomes frayed or damaged, or if there is a sudden loss of sound during use of the instrument, or if any unusual smells or smoke should appear to be caused by it, immediately turn off the power switch, disconnect the electric plug from the outlet, and have the instrument inspected by qualified Yamaha service personnel.



CAUTION

Always follow the basic precautions listed below to avoid the possibility of physical injury to you or others, or damage to the instrument or other property. These precautions include, but are not limited to, the following:

Power supply/Power cord

- When removing the electric plug from the instrument or an outlet, always hold the plug itself and not the cord. Pulling by the cord can damage it.
- Remove the electric plug from the outlet when the instrument is not to be used for extended periods of time, or during electrical storms.
- Do not connect the instrument to an electrical outlet using a multiple-connector. Doing so can result in lower sound quality, or possibly cause overheating in the outlet.

Assembly

- Read carefully the attached documentation explaining the assembly process. Failure to assemble the instrument in the proper sequence might result in damage to the instrument or even injury.

Location

- Do not expose the instrument to excessive dust or vibrations, or extreme cold or heat (such as in direct sunlight, near a heater, or in a car during the day) to prevent the possibility of panel disfiguration or damage to the internal components.
- Do not use the instrument in the vicinity of a TV, radio, stereo equipment, mobile phone, or other electric devices. Otherwise, the instrument, TV, or radio may generate noise.
- Do not place the instrument in an unstable position where it might accidentally fall over.
- Before moving the instrument, remove all connected cables.
- When setting up the product, make sure that the AC outlet you are using is easily accessible. If some trouble or malfunction occurs, immediately turn off the power switch and disconnect the plug from the outlet. Even when the power switch is turned off, electricity is still flowing to the product at the minimum level. When you are not using the product for a long time, make sure to unplug the power cord from the wall AC outlet.

Connections

- Before connecting the instrument to other electronic components, turn off the power for all components. Before turning the power on or off for all components, set all volume levels to minimum. Also, be sure to set the volumes of all components at their minimum levels and gradually raise the volume controls while playing the instrument to set the desired listening level.

Maintenance

- In the case of a model with a polished finish, gently remove dust and dirt with a soft cloth. Do not wipe too hard since small particles of dirt can scratch the instrument's finish.
- When cleaning the instrument, use a soft, dry or slightly damp cloth. Do not use paint thinners, solvents, cleaning fluids, or chemical-impregnated wiping cloths.

Handling caution

- Take care that the key cover does not pinch your fingers, and do not insert a finger or hand in any gaps on the key cover or instrument.
- Never insert or drop paper, metallic, or other objects into the gaps on the key cover, panel or keyboard. If this happens, turn off the power immediately and unplug the power cord from the AC outlet. Then have the instrument inspected by qualified Yamaha service personnel.
- Do not place vinyl, plastic or rubber objects on the instrument, since this might discolor the panel or keyboard.
- In the case of a model with a polished finish, bumping the surface of the instrument with metal, porcelain, or other hard objects can cause the finish to crack or peel. Use caution.
- Do not rest your weight on, or place heavy objects on the instrument, and do not use excessive force on the buttons, switches or connectors.
- Do not use the instrument/device or headphones for a long period of time at a high or uncomfortable volume level, since this can cause permanent hearing loss. If you experience any hearing loss or ringing in the ears, consult a physician.

Using the bench (If included)

- Do not place the bench in an unstable position where it might accidentally fall over.
- Do not play carelessly with or stand on the bench. Using it as a tool or step-ladder or for any other purpose might result in accident or injury.
- Only one person should sit on the bench at a time, in order to prevent the possibility of accident or injury.
- If the bench screws become loose due to extensive long-term use, tighten them periodically using the included tool.

Saving data

Saving and backing up your data

- Current data (page 45) is lost when you turn off the power to the instrument before saving. Save the data to a USB storage device/external device such as a computer.

Saved data may be lost due to malfunction or incorrect operation. Save important data to a USB storage device/external device such as a computer.

Yamaha cannot be held responsible for damage caused by improper use or modifications to the instrument, or data that is lost or destroyed.

Always turn the power off when the instrument is not in use.

Thank you for choosing the Yamaha Clavinova CLP-295GP.

In order to make the most of your Clavinova's performance potential and features, please read this Owner's Manual thoroughly, and keep it in a safe place for later reference.

About this Owner's Manual and Data List

This manual consists of four main sections: "Introduction," "Basic Operation," "Detailed Settings," and "Appendix." Also, a separate "Data List" is provided.

Introduction: Please read this section first. In the "Application Index" section on page 8 and "Features" on page 10, you can learn how to use the Clavinova and its functions in particular situations.

Basic Operation: This main section explains how to use the basic functions. Refer to this section while you play the Clavinova. If you have questions or come across the words you do not know, refer to the section entitled "Questions about Operations and Functions" on page 101, or the "Index" on page 117.

Detailed Settings: This section explains how to make detailed settings for the Clavinova's various functions. Refer to this section as necessary.

Appendix: This section introduces troubleshooting, a description of preset voices, and other reference material.

Data List: XG Voice List, MIDI Data Format, etc.

- The models CLP-295GP will be referred to as the CLP/Clavinova in this Owner's Manual.
- The illustrations and LCD screens as shown in this Owner's Manual are for instructional purposes only, and may appear somewhat different from those on your instrument.
- Copying of commercially available software or music data for purposes other than your personal use is strictly prohibited.

COPYRIGHT NOTICE

This product incorporates and bundles computer programs and contents in which Yamaha owns copyrights or with respect to which it has license to use others' copyrights. Such copyrighted materials include, without limitation, all computer software and MIDI files, etc. Any unauthorized use of such programs and contents outside of personal use is not permitted under relevant laws. Any violation of copyright has legal consequences. DON'T MAKE, DISTRIBUTE OR USE ILLEGAL COPIES. This device is capable of using various types/formats of music data by optimizing them to the proper format music data for use with the device in advance. As a result, this device may not play them back precisely as their producers or composers originally intended.

Trademarks

- Apple and Macintosh are trademarks of Apple Computer, Inc., registered in the U.S. and other countries.
- Windows is the registered trademark of Microsoft® Corporation.
- SmartMedia is a trademark of Toshiba Corporation.
- All other trademarks are the property of their respective holders.

Tuning

Unlike an acoustic piano, the Clavinova does not need to be tuned. It always stays perfectly in tune.

Transporting

If you move to another location, you can transport the Clavinova along with your other belongings. You can move the unit as it is (assembled) or you can disassemble the unit.

Transport the keyboard horizontally. Do not lean it up against a wall or stand it up on its side. Do not subject the instrument to excessive vibration or shock.

After transporting the instrument, do the following to ensure optimum performance of the iAFC function (page 83):

- Do not block the speaker located on the bottom face of the Clavinova.
- Perform the automatic adjustment of the iAFC function (page 84).

Included Accessories

- "50 greats for the Piano" Score Collection
- Owner's Manual
- Data List
- Bench (included or optional depending on locale)
- Accessory CD-ROM for Windows
- Accessory CD-ROM for Windows Installation Guide

Table of contents

Introduction..... 2

PRECAUTIONS 3

- About this Owner's Manual and Data List 5
- Included Accessories 5

Application Index 8

Panel Controls and Terminals 10

Introduction to the Controls..... 12

Before Using the Clavinova..... 14

- About the key cover 14
- About the music rest 14
- About the music braces..... 14
- About the Lid 15
- Turning the power on..... 16
- Adjusting the display contrast 17
- Setting the volume 17
- Using headphones..... 17
- Performing the iAFC automatic adjustment..... 18

Basic Operation 19

Listening to the Demonstration Tunes..... 20

Listening to 50 Piano Preset Songs 22

- Playing the 50 piano preset songs 22
- Practicing a one-hand part using 50 preset songs 24
- Practicing with the Repeat Playback function and the preset songs 25

Selecting and Playing Voices 27

- Selecting Voices 27
- Using the pedals 28
- Adding variation to the sound [BRILLIANCE]/[REVERB]/[CHORUS] 29
- Combining two voices (Dual mode)..... 31
- Splitting the keyboard range and playing two different voices (Split mode) 33
- Using the metronome 35

Recording Your Performance..... 36

- Recording a New Song..... 36
- Recording a performance without specifying the recording part 37
- Recording a performance of several different parts 41
- Other recording techniques..... 42

Handling files such as deleting song files ... [FILE/SONG SETTING]..... 45

- Saving recorded songs to a USB storage device ... [Save] 48
- Deleting a song from the Clavinova's Storage memory or from a USB storage device ... [Delete] 49
- Renaming files ... [Rename] 50
- Copying files ... [Copy] 51
- Moving files ... [Move]..... 53

Making folders in the USB storage device ... [MakeDir]	54
Formatting a USB storage device ... [Format]	54
Automatically selecting a song in storage media ... [SongAutoOpen]	55
Changing the type of characters on screen ... [CharCode]	55
Playing Back Recorded Songs and Commercially-available Music Data	56
Playing back a song	56
Turning part playback on and off	59
Supported song data type	59
Connections	60
Connectors	60
Connecting to a USB storage device	62
Connecting a personal computer	65

Detailed Settings 67

Detailed Settings.....	68
Parameter List	68
Making detailed settings	71
Detailed settings for recording and playback [FILE/SONG SETTING]	73
Detailed settings for the metronome METRONOME [SETTING]	76
Detailed settings for the voices [VOICE SETTING]	77
Detailed settings for iAFC [iAFC SETTING]	83
Other settings [FUNCTION]	85
Message List	95
Questions about Operations and Functions	101

Appendix 103

Troubleshooting.....	104
Data Compatibility	106
Preset Voice List	108
Voice Combination Examples (Dual and Split)	110
CLP-295GP: Keyboard Stand Assembly	111
Handling the Floppy Disk Drive (FDD) and Floppy Disks (Optional)	114
Installing the Floppy Disk Drive (Optional).....	115
Specifications	116
Index.....	117

Application Index

Use this index to find reference pages that may be helpful for your application and situation.

Listening

- Listening to demo songs.....“Listening to the Demonstration Tunes” on page 20
“Playing the 50 Piano Preset Songs” on page 22
- Listening to demo songs with different voices“Listening to the Demonstration Tunes” on page 20
- Listening to songs from “50 greats for the Piano” “Playing the 50 Piano Preset Songs” on page 22
- Listening to my recorded performance
.....“Playing Back Recorded Songs and Commercially-available Music Data” on page 56
- Listening to songs in the USB storage device“Connecting to a USB storage device” on page 62
“Playing Back Recorded Songs and Commercially-available Music Data” on page 56

Playing

- Using three pedals.....“Using the pedals” on page 28
- Playing an accompaniment that matches pitch “Changing the key [Transpose]” on page 85

Changing tonal color

- Viewing the list of voices “Preset Voice List” on page 108
- Simulating a concert hall..... “[REVERB]” on page 30
- Combining two voices “Combining two voices (Dual mode)” on page 31
- Playing different sounds with left and right hands
..... “Splitting the keyboard range and playing two different voices (Split mode)” on page 33
- Making a voice brighter and sharper, or softer and smoother “[BRILLIANCE]” on page 29
- Adding spread to the sound “[CHORUS]” on page 30
- Making the sound three-dimensional “Detailed settings for iAFC [iAFC SETTING]” on page 83

Practicing

- Muting the right- or left-hand part “Practicing a one-hand part using 50 preset songs” on page 24
- Practicing with an accurate and steady tempo.....“Using the metronome” on page 35
- Practicing using your recorded song “Recording Your Performance” on page 36
“Turning part playback on and off” on page 59

Recording

- Recording your performance “Recording Your Performance” on page 36
- Deleting or copying the recorded songs
..... “Handling files such as deleting song files ... [FILE/SONG SETTING]” on page 45

Use this index to find reference pages that may be helpful for your application and situation.

Settings

Making detailed settings for recording and playback
 “Detailed settings for recording and playback [FILE/SONG SETTING]” on page 73

Making detailed settings for the metronome
 “Detailed settings for the metronome METRONOME [SETTING]” on page 76

Making detailed settings for the voices
 “Detailed settings for the voices [VOICE SETTING]” on page 77

Making detailed settings for the Clavinova “Other settings [FUNCTION]” on page 85

Connecting the Clavinova to other devices

What is MIDI?..... “About MIDI” on page 60

Making detailed settings for MIDI
 “Setting the MIDI transmit channel” – “Selecting a type of data transmitted via MIDI” on pages 91 – 92

Recording your performance “AUX OUT [L] [R] Pin jacks” on page 61

Raising the volume “AUX OUT [L] [R] Pin jacks” on page 61

Outputting other instruments’ sound from the Clavinova “AUX IN [L/L+R], [R] jacks” on page 61

Connecting to a USB storage device “Connecting to a USB storage device” on page 62

Connecting a computer “Connecting a personal computer” on page 65

Assembling

Assemble/disassemble the Clavinova..... “CLP-295GP: Keyboard Stand Assembly” on page 111

Quick solution

What the Clavinova offers “Application Index” on page 8
 “Panel Controls and Terminals” on page 10

Returning to the main screen..... “EXIT button” on page 13

Resetting the Clavinova to the default setting
 “Restoring the normal (default) settings [FactorySet]” on page 93

Meaning of the messages..... “Message List” on page 95

If you have questions about operations and functions
 “Questions about Operations and Functions” on page 101

Troubleshooting..... “Troubleshooting” on page 104

Panel Controls and Terminals

The Yamaha CLP-295GP Clavinova offers unmatched sonic realism and exceptionally natural grand-piano type playability, and features Yamaha's original AWM Dynamic Stereo Sampling technology for rich, authentic, musical voices.

The special Natural Wood keyboard uses real wood white keys, to reproduce as closely as possible the experience of playing an actual acoustic grand piano.

Thanks to these two keyboard types, you can use performance techniques previously possible only on grand pianos—such as playing the same note successively and having sounds blend smoothly even without use of the damper pedal, or playing the same key quickly and having perfect articulation without the sound cutting off unnaturally. The remarkably authentic Grand Piano 1 voice on both instruments also features:

- Dynamic Sampling, using velocity-switched samples for extra realism;
- String Resonance (page 90), which recreates the rich resonance of piano strings;
- Sustain Sampling (page 90), which uses samples of the resonance of an acoustic grand piano's soundboard and strings made when the damper pedal is pressed; and
- Keyoff Samples, which add the subtle, characteristic sounds produced when keys are released.

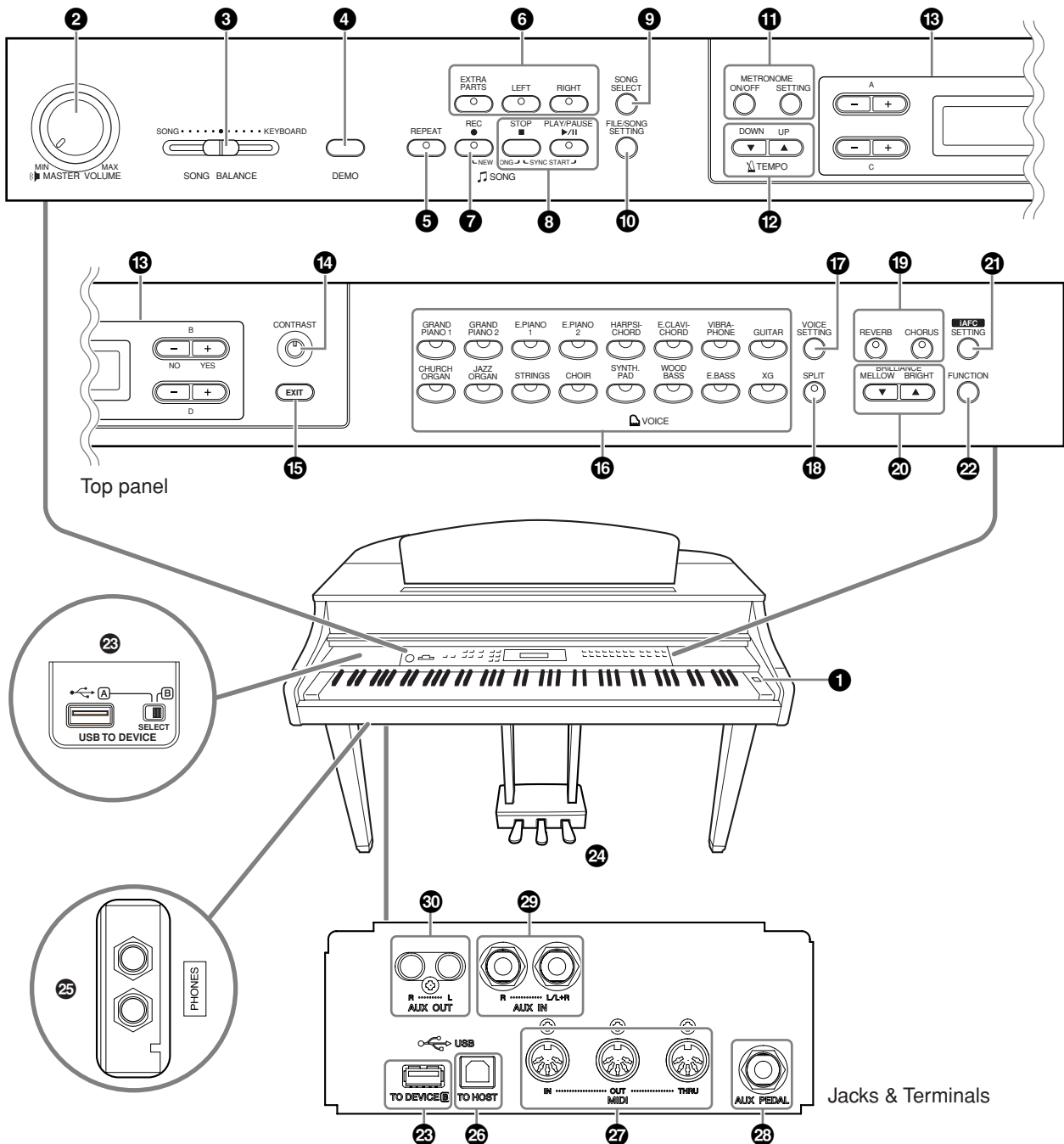

- ❶ **[POWER] switch** page 16
- ❷ **[MASTER VOLUME] dial** page 17
Adjust the volume level using this dial.
- ❸ **[SONG BALANCE] slider** page 44
This lets you adjust the volume balance between the song playback and the sound you are playing on the keyboard.
- ❹ **[DEMO] button** page 20
Demonstration playback is available for each voice.
- ❺ **[REPEAT] button** page 25
For repeatedly playing back a single song or specifying a range (in beats) within a song for repeated playback.
- ❻ **[RIGHT], [LEFT], [EXTRA PARTS] buttons** pages 24, 36, 41
For turning the left- and right-hand parts on or off as required so you can practice the corresponding part (the part that is turned off) on the keyboard.
- ❼ **[REC] button** page 36
For recording your keyboard performance.
- ❽ **[PLAY/PAUSE], [STOP] buttons** pages 22, 56
For playing back the preset songs, your recorded material or commercially available music data, etc.
- ❾ **[SONG SELECT] button** pages 22, 56
For selecting a song to play back or edit.
- ❿ **[FILE/SONG SETTING] button** pages 45, 73
For saving recorded songs and managing song files. Also lets you make detailed settings for song recording and playback.
- ⓫ **METRONOME [ON/OFF], METRONOME [SETTING] buttons** pages 35, 68, 76
For using the metronome functions.
- ⓬ **TEMPO [UP][DOWN] buttons** page 35
For changing the tempo (speed) of the song and metronome.
- ⓭ **A – D [–][+] buttons, Display** page 12
- ⓮ **[CONTRAST] knob** page 17
For adjusting the display contrast.
- ⓯ **[EXIT] button** page 13
Pressing this button returns to the main operation display (the one shown when the power is turned on).
- ⓰ **Voice group buttons** page 27
For choosing voice groups. Sixteen groups of voices, including grand piano, are available. You can also combine two voices and use them together.
- ⓱ **[VOICE SETTING] button** pages 69, 77
For making detailed changes to the voice sound and effects.
- ⓲ **[SPLIT] button** page 33
For playing different voices on the left- and right-hand sections of the keyboard.
- ⓳ **[REVERB], [CHORUS] buttons** page 30
For adding reverb and chorus effects to the sound.

- ⓴ **BRILLIANCE [MELLOW][BRIGHT] buttons** page 29
For adjusting the brightness of the sound.
- ⓵ **[iAFC SETTING] button** pages 69, 83
When iAFC is engaged, the Clavinova will sound deeper, more resonant, and more similar to the sound of an actual acoustic instrument. You can turn the iAFC function on or off or make detailed settings for the iAFC.

In order to obtain the optimal results from iAFC, we recommend that you do the following.

- Do not block the speaker located on the bottom face of the Clavinova.
- Perform the automatic adjustment after you turn on the power of the Clavinova for the first time, and after each time you move the Clavinova (page 84).

- ⓶ **[FUNCTION] button** pages 70, 85
This lets you make detailed settings, such as adjusting the keyboard touch, making fine adjustments to the pitch or MIDI settings.
- ⓷ **USB [TO DEVICE] terminals** page 60
For connecting the instrument to a USB storage device, allowing saving/loading of data to and from the connected device. The instrument has two [TO DEVICE] terminals, A and B, which can be specified using the [SELECT] switch.
- ⓸ **Soft pedal (left), Sostenuto pedal (center), Damper pedal (right)** page 28
For producing a range of expressive effects similar to those produced by the pedals on an acoustic piano. These pedals can also be assigned to various functions.
- ⓹ **[PHONES] jacks** page 17
For connecting a set of standard stereo headphones, allowing private practice.
- ⓺ **USB [TO HOST] terminal** page 60
For connecting the instrument to your computer, allowing you to transfer MIDI data between the Clavinova and the computer.
- ⓻ **MIDI [IN][OUT][THRU] terminals** page 60
For connecting external MIDI devices, allowing the use of various MIDI functions.
- ⓼ **[AUX PEDAL] jack** page 60
For connecting an optional pedal, allowing convenient foot control over one of a variety of assignable functions.
- ⓽ **AUX IN [L/L+R] [R] jacks** page 61
For connecting an external tone generator, allowing you to play the sound of that device via the Clavinova's internal sound system and speakers.
- ⓾ **AUX OUT [L][R] jacks** page 61
For outputting the sound of the Clavinova to an external audio system, or connecting it to another device (cassette tape recorder, etc.) to record your performance.

Introduction to the Controls

This instrument has many buttons and controls—so many that you may feel overwhelmed at first. However, once you understand the basic operations, you'll find the instrument is very easy to use.

Press the button corresponding to the function you want to use.

The buttons are the means of entrance to the functions.

For example, when you want to change a voice, you simply press one of the voice group buttons on the right of the panel, or when you want to listen to a preset song, press the [SONG SELECT] button on the left of the panel.

For the functions that are assigned to each button, see “Panel Controls and Terminals” on page 10.

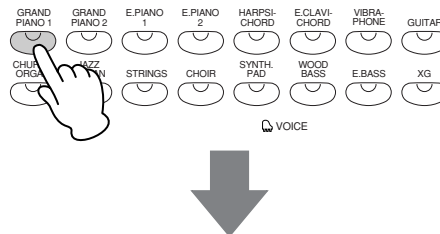

When you press a button, related content or parameter is shown in the display. For example, when you press a voice button, the voice name is shown, or when you press the [SONG SELECT] button, a song name is shown on the display. After pressing a button, check the display for the indication.

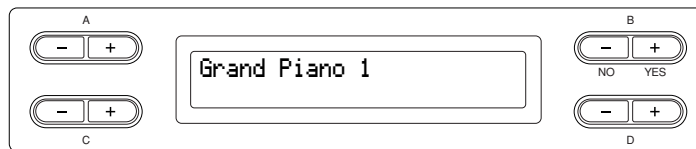

Selecting items/parameters with the buttons on the side of the display.

Each function may have many items or parameters from which you can choose. To select an item or parameter, press one of the A [-][+] – D [-][+] buttons. Each parameter in the display corresponds to the A [-][+] – D [-][+] button next to it.

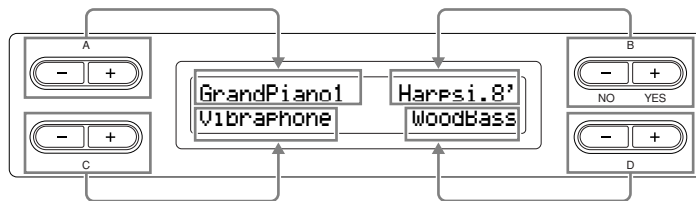

■ **To reset the values or parameters, press the [-][+] buttons simultaneously.**

If you've changed the parameter values or settings, you may want to reset them to their normal condition. To do this, simply press the [-][+] buttons simultaneously.

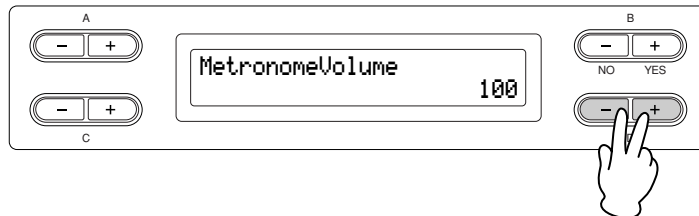

The TEMPO and BRILLIANCE buttons are the same shape as the A [-][+] - D [-][+] buttons. You can reset the related values or parameters by simultaneously pressing buttons of this shape.

■ **To execute or cancel the operation, press the B [- (NO)] [+ (YES)] button.**

When a prompt is shown on the upper right of the display, press the B [- (NO)][+ (YES)] button to execute or cancel the operation.

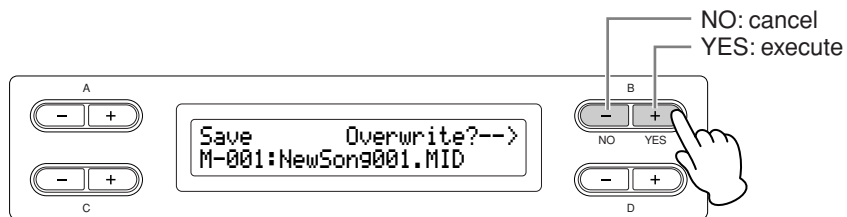

Press the [EXIT] button to exit from a function.

The [EXIT] button is the means to "leave" a function.

After you've used a function and want to exit from it, press the [EXIT] button.

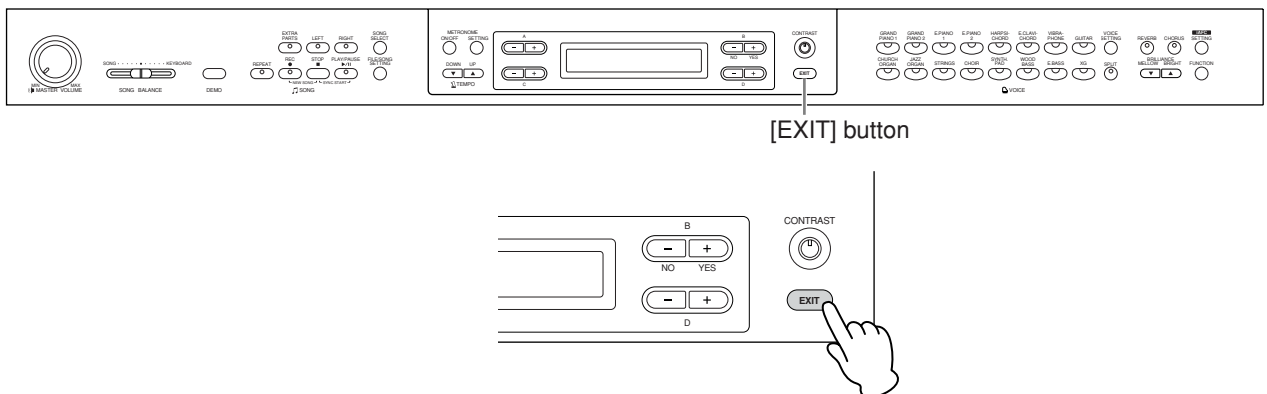

Before Using the Clavinova

About the key cover

To open the key cover:

Lift the cover slightly, then push and slide it open.

To close the key cover:

Slide the cover toward you and gently lower the cover over the keys.

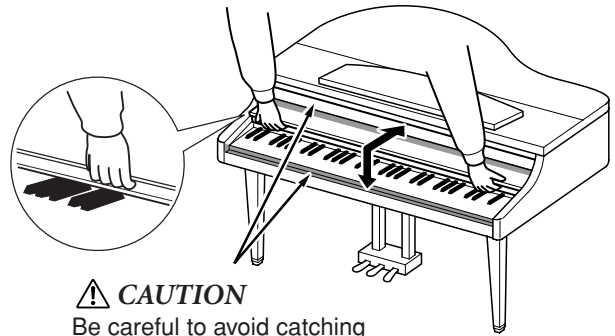

⚠ CAUTION
Be careful to avoid catching your fingers when opening or closing the cover.

⚠ CAUTION

Hold the cover with both hands when opening or closing it. Do not release it until it is fully opened or closed. Be careful to avoid catching fingers (yours or others, especially children's) between the cover and the unit. Do not place objects such as a piece of metal or paper on top of the key cover. Small objects placed on the key cover may fall inside the unit when the cover is opened and may be nearly impossible to remove. This could cause electric shock, short circuit, fire or other serious damage to the instrument.

About the music rest

To raise the music rest:

1. Pull the music rest up and toward yourself as far as it will go.
2. Flip down the two metal supports at the left and right on the rear of the music rest.
3. Lower the music rest so that it rests on the metal supports.

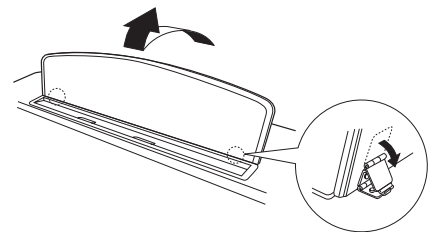

To lower the music rest:

1. Pull the music rest toward yourself as far as it will go.
2. Raise the two metal supports (at the rear of the music rest).
3. Gently lower the music rest backward until it is all the way down.

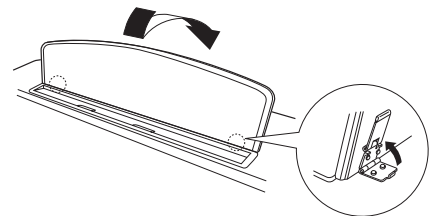

⚠ CAUTION

Do not try to use the music rest in a half-raised position. When lowering the music rest, do not release your hands from the music rest until it is all the way down.

About the music braces

These braces are for holding the pages of music books in place.

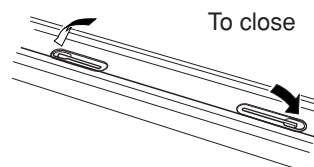
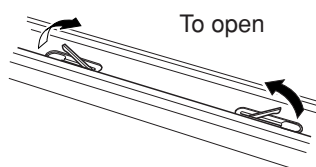

About the Lid

One long stay and one short stay are provided on the lid. Use one of them to open the lid to the desired angle.

Longer stay

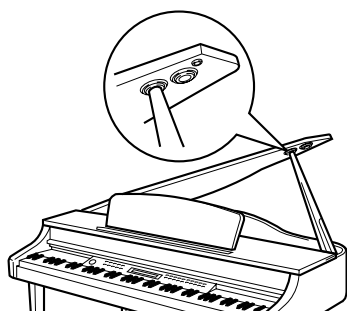

Shorter stay

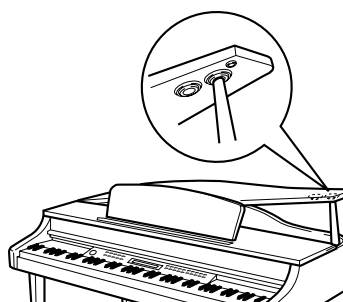

NOTE

For the longer stay, use the inner recess, and for the shorter stay, use the outer recess to support the lid.

To open the lid:

1. Raise and hold the right side of the lid (viewed from the keyboard end of the instrument).
2. Raise the lid stay and carefully lower the lid so that the end of the stay fits into the recess in the lid.

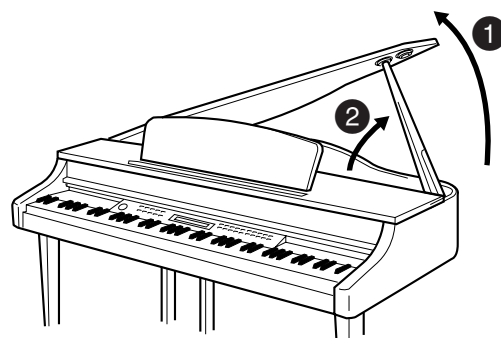

To turn on the iAFC (page 83), open the lid with the longer stay using the inner recess.

When the lid is closed or open with the shorter stay, the iAFC will not be turned on.

To close the lid:

1. Hold the lid stay and carefully raise the lid.
2. Hold the lid in its raised position and lower the lid stay.
3. Carefully lower the lid.

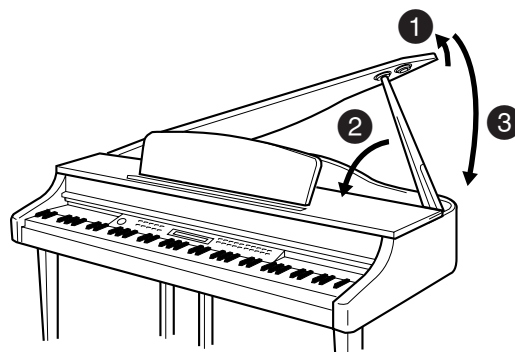

⚠ CAUTION

- Make sure that the end of the stay fits securely in the lid recess. If the stay is not properly seated in the recess, the lid may fall, causing damage or injury.
- Be careful that you or others do not bump the stay while the lid is raised. The stay may be bumped out of the lid recess causing the lid to fall.
- Be careful to avoid catching fingers (yours or others, especially children's) when raising or lowering the lid.

Turning the power on

1. Connect the power cable.

First insert the plug of the power cable into the AC connector on the Clavinova, then plug the other end of the cable into the proper AC outlet on the wall.

In some areas a plug adaptor may be provided to match the pin configuration of the AC wall outlets in your area.

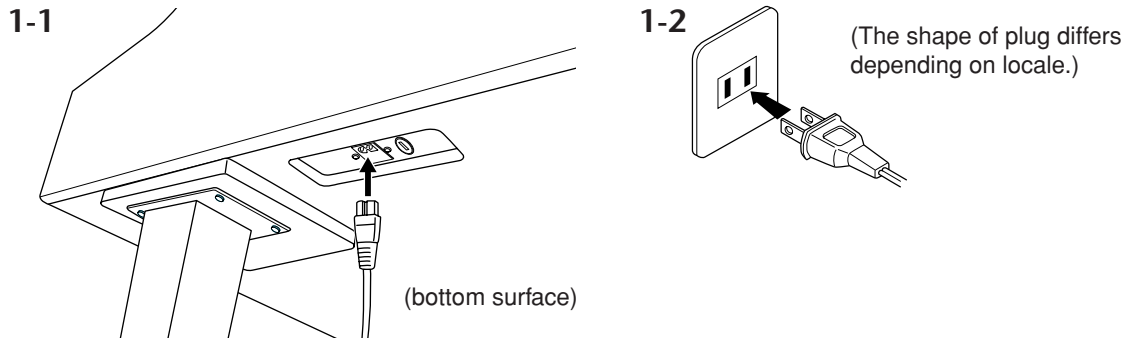

⚠ WARNING!

Make sure your CLP-295GP is rated for the AC voltage supplied in the area in which it is to be used (voltage rating appears on the name plate on the bottom panel). In some areas, a voltage selector may be provided on the bottom panel of the main keyboard unit near the power cord. Make sure that the voltage selector is set for the voltage in your area. Connecting the unit to the wrong AC supply can cause serious damage to the internal circuitry and may even pose a shock hazard!

Use only the AC power cord supplied with the CLP-295GP. If the supplied cord is lost or damaged and needs to be replaced, contact your Yamaha dealer. The use of an inappropriate replacement can pose a fire and shock hazard!

The type of AC power cord provided with the CLP-295GP may be different depending on the country in which it is purchased. (In some areas a plug adaptor may be provided to match the pin configuration of the AC wall outlets in your area.) Do NOT modify the plug provided with the CLP-295GP. If the plug will not fit the outlet, have a proper outlet installed by a qualified electrician.

2. Turn on the power to the Clavinova.

Press the [POWER] switch located on the right of the keyboard to turn the power on.

- The screen located in the center of the front panel and the power indicator located below the left end of the keyboard lights up.

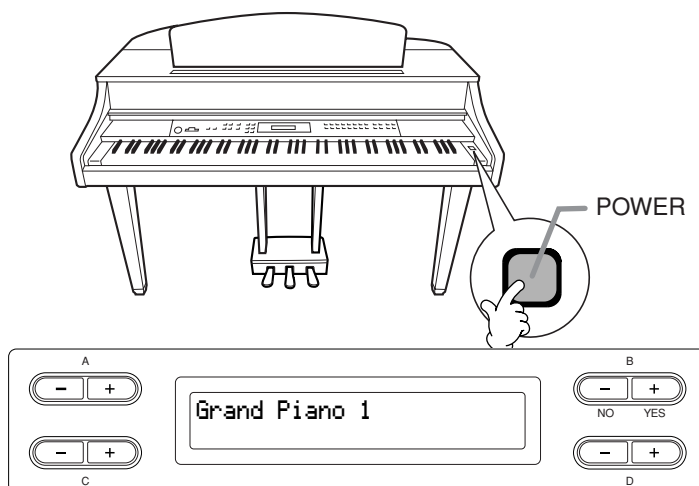

When you turn on the power to the Clavinova, a voice name appears on the screen.

Press the [POWER] switch again to turn off the power to the Clavinova.

- The screen and the power indicator turn off.

TIP

Power indicator

If you close the key cover without turning the power off, the power indicator remains lit, indicating that the power is still on.

Adjusting the display contrast

You can adjust the contrast of the display by turning the [CONTRAST] knob located to the right of the LCD.

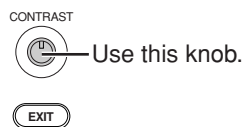
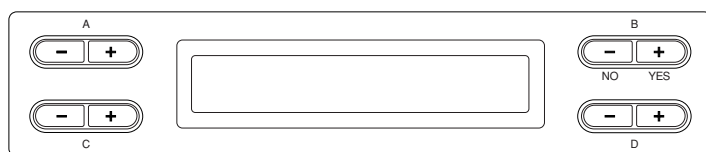

TERMINOLOGY
CONTRAST:
 difference between
 brightness and darkness

Setting the volume

To adjust the volume, use the [MASTER VOLUME] dial located at the left of the panel. Play the keyboard to actually produce sound while you adjust the volume.

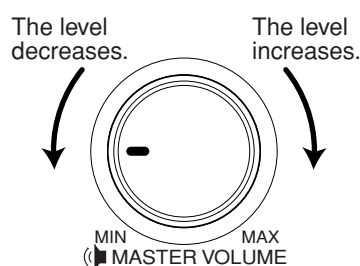

CAUTION
 Do not use the Clavinova at a high volume level for a long period of time, or your hearing may be damaged.

TERMINOLOGY
MASTER VOLUME:
 The volume level of the entire keyboard sound

TIP
 You can also adjust the [PHONES] output level, AUX [IN] input level and the AUX [OUT] output level (when "Variable" is selected in "AuxOutLevel" on page 91) using the [MASTER VOLUME] dial.

Using headphones

Connect a pair of headphones to one of the [PHONES] jacks. When the headphones are plugged into either of the [PHONES] jacks, the internal speaker system is automatically shut off. Two [PHONES] jacks are provided. Two sets of standard stereo headphones can be plugged in. (If you are using only one pair of headphones, you can plug them into either of these jacks.)

CAUTION
 Do not use headphones at a high volume for an extended period of time. Doing so may cause hearing loss.

TIP
Optional headphones
 HPE-160 Yamaha headphones.

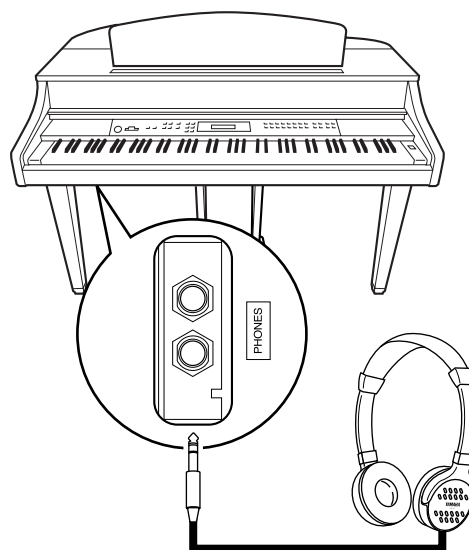

Using the Headphone Hanger

A headphone hanger is included in the CLP-295GP package so that you can hang the headphones on the Clavinova. Install the headphone hanger using included two screws (4 × 10mm) as shown in the figure.

CAUTION
 Do not hang anything other than the headphones on the hanger. Otherwise, the Clavinova or the hanger may be damaged.

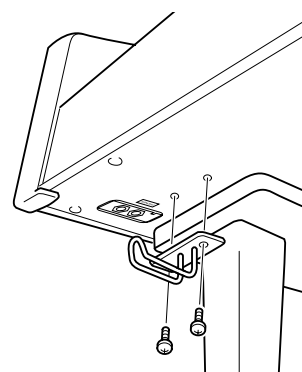

Performing the iAFC automatic adjustment

The CLP-295GP features an iAFC (Instrumental Active Field Control) effect. This produces sound from the speaker located on the bottom face of the Clavinova, enhancing the reverberation and spaciousness of the sound when you open the lid with the longer stay. (page 15)

In order to optimize the iAFC effect, perform the automatic adjustment. (page 83)



Basic Operation

Listening to the Demonstration Tunes

For each voice group, the Clavinova contains one demo song that shows off the character of the voices. This section explains how to listen to the demo songs for the voice groups listed below.

Demonstration tunes

Voice group	Tunes	Composer
GRAND PIANO1	“Eintritt” Waldszenen Op. 82	R.Schumann
HARPSICHORD	Gavotte	J.S.Bach

The demonstration pieces listed above are short rearranged excerpts the original compositions.

All other songs are original (©2005 Yamaha Corporation).



Procedure

1. Engage the demo mode.

Press the [DEMO] button to engage the demo mode.

The indicators of the voice group buttons will blink in succession.

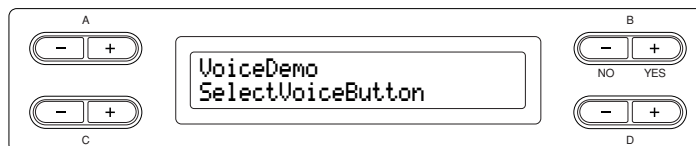

TERMINOLOGY

Mode:

A mode is a status under which you can execute a certain function. In demo mode, you can play back demonstration tunes.

2. Select a tune and start playback.

Press the voice group button for the demo song that you want to hear.

The indicator of the voice group button you pressed will light, and the demo song will begin playing. Subsequently, the demo songs will play back consecutively from the upper left voice group button until you stop the playback.

3. Stop the playback and exit from demo mode.

Press the [DEMO] button.

By holding down the [DEMO] button and pressing the A [+] button to get the “Piano Demo” display, you can hear the piano demo/iAFC demo. The piano demo lets you compare the result of enabling/disabling each sampling technology.

The iAFC demo lets you compare the result of turning iAFC on/off. The demo songs are assigned to the voice group buttons as follows.

GRAND PIANO1..... Stereo Piano (stereo sampling)
 GRAND PIANO2..... Mono Piano (mono sampling)
 E.PIANO1mezzo piano (dynamic sampling, mezzo piano)
 E.PIANO2mezzo forte (dynamic sampling, mezzo forte)
 HARPSICHORD..... forte (dynamic sampling, forte)
 E.CLAVICHORD with Sustain (with sustain sampling)
 VIBRAPHONE..... no Sustain (without sustain sampling)
 GUITAR with KeyOff (with key-off sampling)
 CHURCH ORGAN..no KeyOff (without key-off sampling)
 JAZZ ORGAN..... with StringRes (with string resonance)
 STRINGSno StringRes (without string resonance)
 CHOIRwith iAFC
 SYNTH.PAD..... no iAFC

TIP

To adjust the volume level of the demo songs, use the [MASTER VOLUME] dial.

TIP

To adjust the volume balance between the song playback and the sound you are playing on the keyboard, use the [SONG BALANCE] slider (page 44).

TIP

You can also exit from demo mode by pressing the [EXIT] or [STOP] button.

Listening to 50 Piano Preset Songs

The Clavinova provides performance data of 50 piano songs. You can just listen to these songs (page 22) or use them for practice (page 24). You can also refer to the included “50 greats for the Piano” booklet that contains the scores for 50 piano preset songs.

Playing the 50 piano preset songs

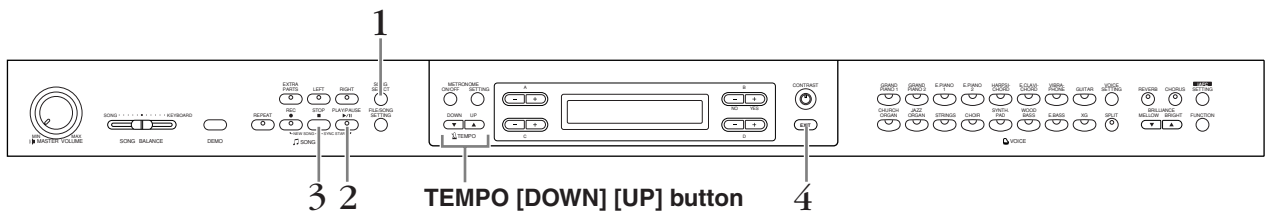

Procedure

1. Select a song.

If “PRESET” does not appear, press the [SONG SELECT] button to call up “PRESET.” Press the C [-]/[+] buttons to select the desired piano song from P-001 to P-050.

Song select screen

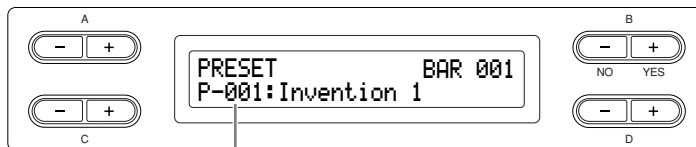

The song number appears on the display.

2. Play a preset song.

Press the [PLAY/PAUSE] button to start playback.

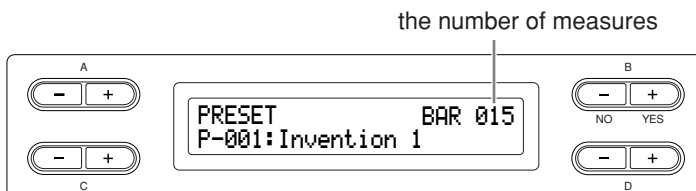

TERMINOLOGY

Song:

On the Clavinova, performance data is called a “Song.” This includes demonstration tunes and piano preset tunes.

TIP

- [----]: NewSong] is a blank song provided for you to record your performance (page 36).
- You can repeatedly play back a single song or specify a range (in beats) within a song for repeated playback by using the [REPEAT] button (page 25). Use the “SongRepeat” parameter in the [FILE/SONG SETTING] menu to repeat playback of all songs (page 73).

TIP

You can play the keyboard along with the preset song playback. You can change the voice playing on the keyboard.

TIP

Use the D [-]/[+] buttons to scroll through the song name, if the name does not fit in the display.

Adjusting the tempo

You can use the TEMPO [DOWN][UP] buttons to adjust the playback tempo as required. The default tempo (the song's original tempo) is set when you press the [DOWN] and [UP] buttons simultaneously. Press either of the [SONG SELECT] button to return to the song select screen.

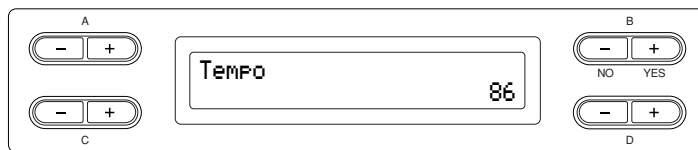

3. Stop the song playback.

When playback is complete, it automatically stops and the Clavinova locates the top of the song. To stop playback in the middle of a song, press the [STOP] button. You can also pause playback by pressing the [PLAY/PAUSE] button. Playback stops when you press the button.

Fast forward and rewind

You can perform the following operations in the song select screen:

- Use the B [-][+] buttons to move back and forth (rewind and fast forward) through the song while the song is played or stopped.
- Press the C [-] button during playback to start playback from the previous song.
- Press the C [+] button during playback to start playback from the next song.
- Press the [STOP] button or simultaneously press the B [-][+] buttons during playback or while playback is stopped in the middle of the song to locate the top of the song.

4. Return to the default screen.

Press the [EXIT] button.

TIP

You can also use the D [-][+] buttons to change the tempo.

TIP

Resetting the tempo
Whenever you select a new preset song, the tempo is automatically reset to the song's original value.

TERMINOLOGY

Default screen:

The default screen is a voice select screen (page 27) that appears when you turn on the power to the Clavinova.

Practicing a one-hand part using 50 preset songs

The 50 preset songs have separate left- and right-hand parts on individual parts. You can turn the left- and right-hand parts on or off as required so you can practice the corresponding part (the part that is turned off) on the keyboard. The right-hand part is played by [RIGHT] and the left-hand part is played by [LEFT].

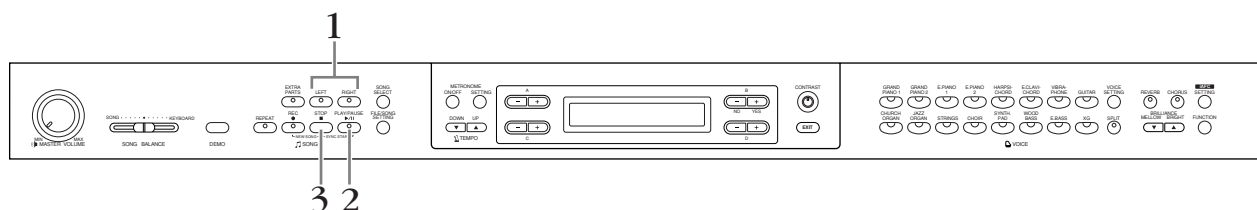

procedure

1. Turn off the playback part you wish to practice.

After you select a song to practice, press the [RIGHT] or [LEFT] button to turn off the corresponding part.

When you first select a song, both [RIGHT] and [LEFT] indicators light up, indicating that you can play back both parts. When you press one of the buttons to turn off playback, the corresponding button indicator turns off and the corresponding part playback is muted. Pressing the buttons repeatedly toggles between playback on and off.

2. Start playback and playing.

Press the [PLAY/PAUSE] button to start playback. Play the part you just turned off.

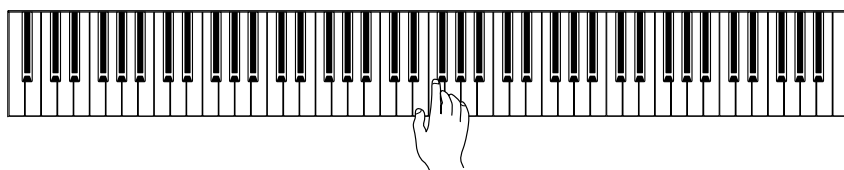

Starting playback automatically as you start playing the keyboard (Sync Start)

You can cause playback to begin when you play the keyboard (Sync Start).

Hold down the [STOP] button and press the [PLAY/PAUSE] button. The [PLAY/PAUSE] indicator will blink, and the Clavinova will wait for Sync Start.

Now when you play the keyboard, playback will begin at the same moment.

If you press the [STOP] button while waiting, Sync Start will be cancelled.

TIP

You can turn parts on or off, even during playback.

TERMINOLOGY

Sync:

Synchronous; occurring at the same time

3. Stop playback.

When playback is complete, it automatically stops and the Clavinova locates the top of the song. If you wish to stop playback in the middle of a song, press the [STOP] button. You can also pause playback by pressing the [PLAY/PAUSE] button. Playback stops when you press the button.

TIP

Resetting the part playback
Both parts are automatically turned ON whenever you select a new song.

Practicing with the Repeat Playback function and the preset songs

The Song Repeat functions can be used to repeatedly play back a song or a specific range of measures in a song. This is useful for repeated practicing of difficult-to-play phrases.

Playing back a song repeatedly

procedure

- 1. Enter the Repeat mode.**
Select a song to practice, then press the [REPEAT] button.
- 2. Start Repeat playback.**
Press the [PLAY/PAUSE] button to start playback.
- 3. Exit the Repeat mode and return to the normal play mode.**
Press the [STOP] button to stop playback, then press the [REPEAT] button.

TIP

You can repeatedly play back all songs from the 50 preset songs or from the USB storage devices (page 73).

Specifying a range of measures and playing them back repeatedly (A-B repeat)

Procedure

- 1. Select the desired song for practicing and play it.**
Press the [PLAY/PAUSE] button to start playback.
- 2. Specify the repeat range.**
Press the [REPEAT] button at the starting point (A) of the range to be repeated. Press the [REPEAT] button again at the ending point (B).

After an automatic lead-in (to help guide you into the phrase), the range from point A to point B is played back repeatedly,
- 3. Cancel the specified range and return to the normal play mode.**
Press the [REPEAT] button.

TIP

Specifying the repeat range between point A and the end of the song. Specifying only point A results in repeat playback between point A and the end of the song.

TIP

When you select another song, the specified range is automatically cancelled and the repeat function is turned off.

Selecting and Playing Voices

Selecting Voices

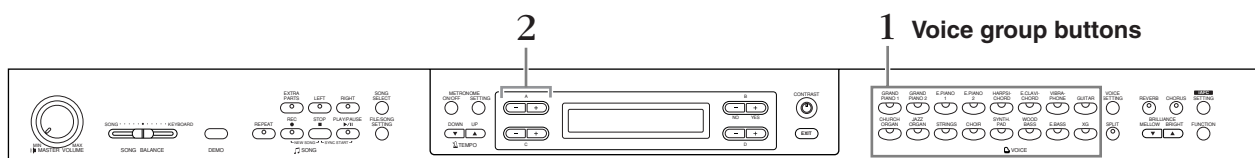

Procedure

1. Select a voice group.
Press a voice group button.
2. Select a voice.
Use A [-][+] buttons to select a voice.

Voice group	Voice name	Voice group	Voice name
GRANDPIANO1	GrandPiano1	CHURCHORGAN	PipeOrganPrincipal
	MellowPiano		PipeOrganTutti
	RockPiano		PipeOrganFlute 1
	HonkyTonkPiano		PipeOrganFlute 2
GRANDPIANO2	GrandPiano2		JAZZORGAN
	BrightPiano	RotaryOrgan	
E.PIANO1	E.Piano1	MellowOrgan	
	SynthPiano	STRINGS	Strings
E.PIANO2	E.Piano2		SynthStrings
	Vintage E.Piano		SlowStrings
HARPSICHORD	Harpsichord8'	CHOIR	Choir
	Harpsichord8'+4'		SlowChoir
E.CLAVICHORD	E.Clavichord		Scat
	Wah Clavi.	SYNTH.PAD	SynthPad 1
VIBRAPHONE	Vibraphone		SynthPad 2
	Marimba	WOOD BASS	WoodBass
	Celesta		Bass&Cymbal
GUITAR	NylonGuitar	E.BASS	ElectricBass
	SteelGuitar		FretlessBass
		XG	XGVoice

- For details on XG voices, refer to “XG voice list” (the separate data list booklet).

If you select XG

XG voices are categorized and included in separate folders. You can select the XG voice group first, then select the desired voice.

- 2-1. Simultaneously press the [-][+] screen buttons located beside the XG voice name display, to access a screen where you can select XG voices.
- 2-2. Use A [-][+] buttons to select the voice group.
- 2-3. Use C [-][+] buttons to select the desired voice.

TERMINOLOGY

Voice

On the Clavinova, a voice means “tone” or “tonal color.”

TIP

You can also switch between voices in the same group by pressing a voice group button repeatedly.

TIP

To learn characteristics of the voices, listen to demo songs for each voice group (page 20). Refer to “Preset Voice List” on page 108 for more information on characteristics of each preset voice.

TIP

You can control the loudness of a voice by how hard you play the keyboard, although different playing styles (touch sensitivities) have little or no effect with the sound of certain musical instruments. Refer to “Preset Voice List” on page 108.

TIP

XG is a major enhancement of the GM System level 1 format, and was developed by Yamaha specially to provide more voices and variations, as well as greater expressive control over voices and effects, and to ensure compatibility of data well into the future.

Using the pedals

The Clavinova has three foot pedals: damper pedal (right), sostenuto pedal (center), and soft pedal (left) that produce a range of expressive effects similar to those produced by the pedals on an acoustic piano.

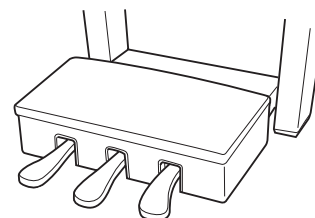

Damper (right) pedal

When you press the damper pedal, the notes you play have a longer sustain. When you select Grand Piano 1, pressing the damper pedal activates the instrument's special "Sustain Samples" to accurately recreate the unique resonance of an acoustic grand piano's soundboard and strings. A "half-pedal" effect lets you use the damper pedal to create partial sustain effects, depending on how far down you press the pedal.

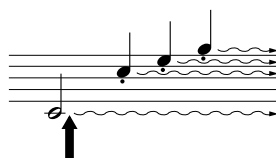

When you press the damper pedal here, the notes you play before you release the pedal have a longer sustain.

TIP

If the damper pedal doesn't work, or notes are sustained even when the pedal is not pressed, make sure that the pedal cord is properly plugged into the [PEDAL] jack on the unit (see step 6 on page 113). Also, make sure that the RPedalFunc parameter in the "FUNCTION" menu is set to ON (see page 87).

TIP

The threshold at which the Half Pedal effect starts can be set from the Half Pedal Point parameter in the Function menu (page 89).

TIP

You can adjust the depth of the resonance produced by the "Sustain Samples" using the Sustain Sampling Depth parameter in the "FUNCTION" menu. (See page 90.)

Sostenuto (center) pedal

If you play a note or chord on the keyboard and press the sostenuto pedal while holding the note(s), the notes will sustain as long as the pedal is held. All subsequent notes will not sustain.

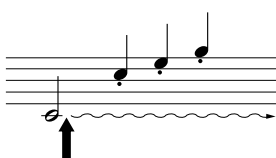

When you press the sostenuto pedal here while holding the note(s), the notes will sustain as long as you hold the pedal.

TIP

You can assign a function to each pedal via the "RPedalFunc", "CPedalFunc", and "LPedalFunc" parameters in the "FUNCTION" menu. (See page 87.)

TIP

The center and left pedals can also be assigned to song start/stop operation (PLAY/PAUSE function) via the "PedalPlay/Pause" parameter in the "FUNCTION" menu (on page 89).

Soft pedal (left)

The soft pedal reduces the volume and slightly changes the timbre of notes played while the pedal is pressed. (The soft pedal will not affect notes that are already playing when it is pressed. Press the pedal immediately before you play the target notes.)

With the Vibraphone, Jazz Organ and Mellow Organ voices, this pedal turns vibrato on and off or toggles the speed of vibrato. (See page 89.)

Adding variation to the sound [BRILLIANCE]/[REVERB]/[CHORUS]

The Effect function enables you to add expression to the sound. The Clavinova effects include Brilliance, Reverb, and Chorus.

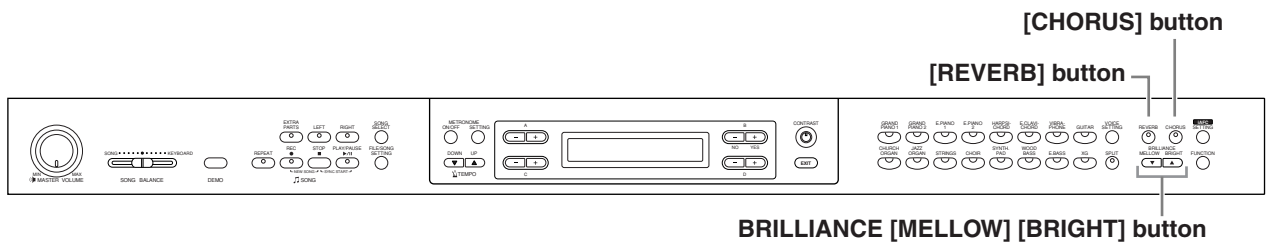

[BRILLIANCE]

You can use this control to adjust the brilliance of the tone and change the tonality to suit your preference.

Procedure

Press one of the **BRILLIANCE** [MELLOW]/ [BRIGHT] buttons to select the desired tonality.

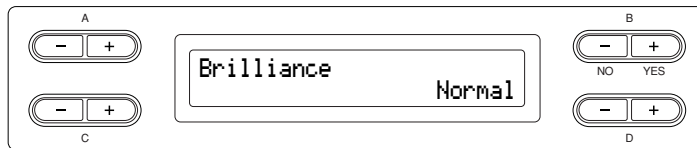

Mellow3 } Soft and mellow tone.
 Mellow2 } The sound becomes more mellow and rounder as the
 Mellow1 } number increases.

Normal..... Standard tone

Bright1 } Bright tone.
 Bright2 } The sound becomes brighter as the number increases.
 Bright3 }

Press the [EXIT] button to return to the main screen.

TIP

You can press BRILLIANCE [MELLOW] [BRIGHT] buttons, and then use D [-][+] buttons to select the desired tonality.

TIP

Normal setting = Normal

TERMINOLOGY

Normal setting:

The "Normal setting" refers to the default setting (factory setting) obtained when you first turn on the power to the Clavinova.

TIP

If you select [Bright1], [Bright2] or [Bright3] as the type of brilliance, the volume level will increase slightly. Under this condition, if you raise the [MASTER VOLUME] dial setting, the sound may become distorted. In this case, lower the volume accordingly.

[REVERB]

This control adds reverberation to the sound by simulating the natural reverberation of a concert hall.

Procedure

Pressing the [REVERB] button repeatedly toggles the reverb on and off.

Even if the reverb effect is turned off, a “soundboard reverb” effect will be applied when the GrandPiano1 or GrandPiano2 voice is selected.

TIP

You can select a reverb type via the Reverb Type parameter in the “VOICE SETTING” menu, and adjust the reverb depth for the selected voice via the Reverb Send parameter. (See page 79.)

TIP

Normal setting = ON

[CHORUS]

This control adds spread and spaciousness to the sound.

Procedure

Pressing the [CHORUS] button repeatedly toggles the chorus on and off.

You can turn the chorus effect on and off by pressing the [CHORUS] ON/OFF buttons on the panel and by setting the Chorus On Off parameter in the VOICE SETTING menu (see page 80). The [CHORUS] ON/OFF button setting on the panel is temporary. That is, if you select another voice, the chorus setting for the previous voice is cancelled. The Chorus On Off parameter setting is saved for each voice. That is, if you select a given voice, the chorus setting is automatically turned on or off according to the saved chorus setting.

TIP

You can select a chorus type via the Chorus Type parameter in the “VOICE SETTING” menu, and adjust the chorus depth for the selected voice via the Chorus Send parameter. You can also turn chorus on or off via the Chorus On Off parameter. (See page 79.)

TIP

Normal Setting:

The normal chorus on/off setting is different for each voice.

Combining two voices (Dual mode)

You can play two voices simultaneously across the entire range of the keyboard. In this way, you can simulate a melody duet or combine two similar voices to create a thicker sound. Refer to “Voice Combination Examples (Dual and Split)” on page 110 for examples of effective voice combinations.

The numbers on the upper row indicate the steps in Dual mode using voices from different group.

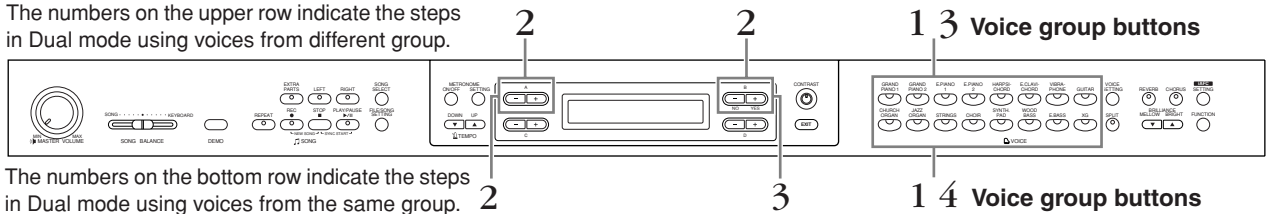

The numbers on the bottom row indicate the steps in Dual mode using voices from the same group.

Dual mode using voices in different voice groups

Procedure

1. Enter Dual mode.
Press two voice group buttons simultaneously.

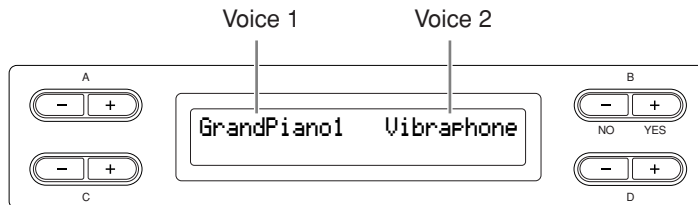

2. Select a voice.
Use the A [-][+] buttons and B [-][+] buttons to select a voice.

The voices listed in the upper row in “Preset Voice List” on page 108 are called voice 1, and those listed in the bottom row are called voice 2.

3. Exit Dual mode and return to normal play mode.
Press any voice group button.

TIP

If you want to select Dual mode for the left-hand area when the entire keyboard is divided into left and right areas (page 33), hold down [SPLIT] button and simultaneously press two voice group buttons.

TIP

Refer to page 27 for details on how to select XG voices.

Dual mode using voices in the same voice group

Procedure

1. **Select a voice group.**
In normal play mode, press the desired voice group button.
2. **Select a voice.**
Use the A [-][+] buttons to select a voice.
3. **Select another voice.**
Use the B [-][+] buttons to select another voice in the same voice group.

To use the identical voices, press the B [-][+] buttons once. To use different voices within the same voice group, press the B [-][+] buttons repeatedly.

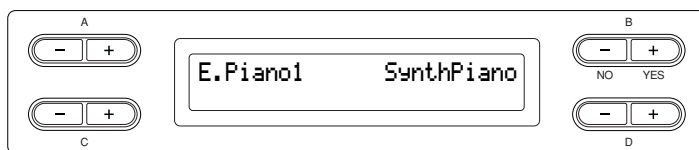

4. **Exit Dual mode and return to normal play mode.**
Press any voice group button.

TIP

If you want to select Dual mode for the left-hand area when the entire keyboard is divided into left and right areas (page 33), press D [-][+] buttons.

Splitting the keyboard range and playing two different voices (Split mode)

Split mode enables you to play two different voices on the keyboard — one with the left hand and another with the right hand. For example, you can play a bass part using the [WOOD BASS] or [E. BASS] voice with the left hand, and a melody with the right hand. Refer to “Voice Combination Examples (Dual and Split)” on page 110 for examples of effective voice combinations.

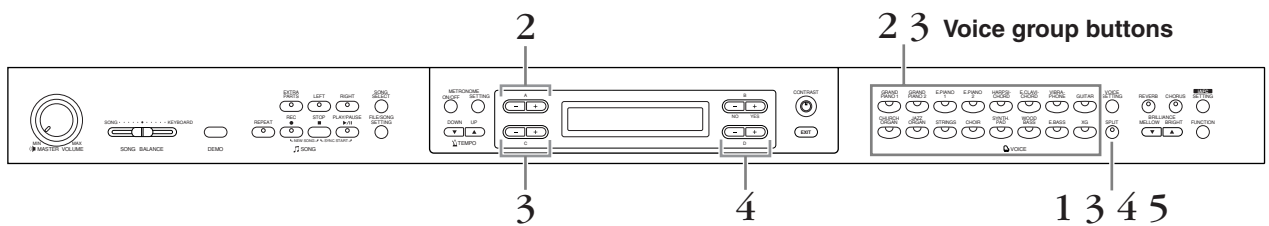

Procedure

- 1.** Enter Split mode.
Press the [SPLIT] button.

- 2.** Select a voice for the right hand.
Use the voice group buttons and the A [-] [+] buttons to select the voice for the right-hand area.

- 3.** Select a voice for the left hand.
Hold down the [SPLIT] button, and press a voice group button to select the voice group for the left-hand area.
Use the C [-] [+] buttons to select a voice.

TIP

Refer to page 27 for details on how to select XG voice.

4. Specify the split point (the border between the right- and left-hand range).

The normal setting of the split point is “F#2.”

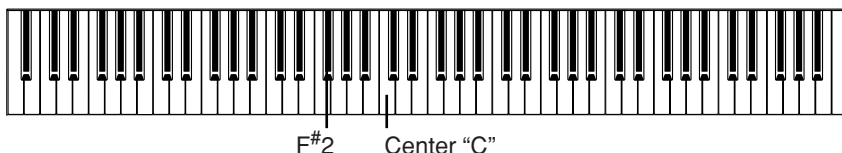

To change the split point setting:

Hold down the [SPLIT] button, then use the D [-] [+] buttons to specify the split point.

(Optional) Press and hold down the [SPLIT] button and play the key you wish to assign as the split point.

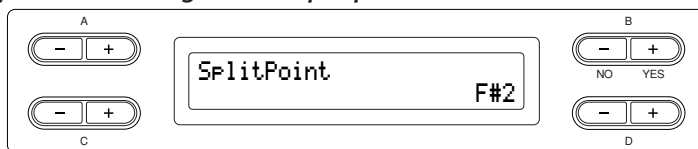

Release the [SPLIT] button to return to the main screen.

5. Exit Split mode and return to normal play mode.

Press the [SPLIT] button.

You can use Dual (see page 31) in each area (right-hand and left-hand) of Split mode.

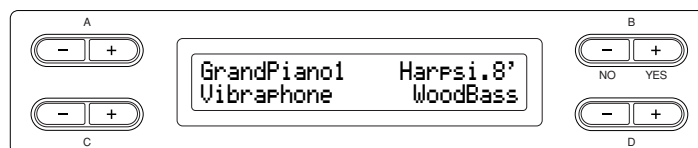

TIP

A specified “split point” key is included in the left-hand range.

TIP

The split point can also be set by the [FUNCTION] parameter [SplitPoint]. (page 87)

Using the metronome

The Clavinova is built-in metronome (a device that keeps an accurate tempo) is a convenient feature for practice.

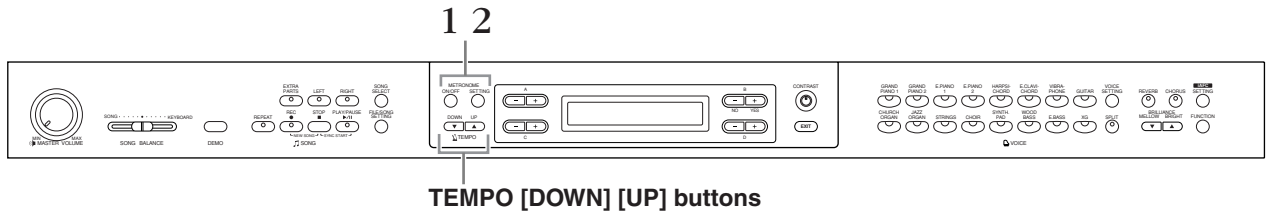

Procedure

1. Start the metronome.
Press the **METRONOME [ON/OFF]** button.

Adjusting the tempo

Press the **TEMPO [DOWN]** or **[UP]** button.

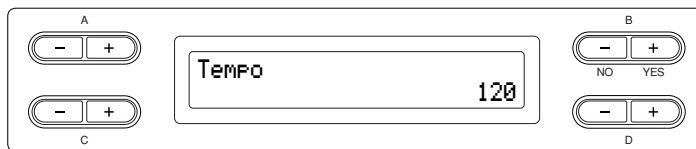

To adjust the tempo (number of beats per minute: 5–500), use the **TEMPO [DOWN][UP]** or the **D [-][+]** buttons. To reset the tempo to the normal (default) setting, press the **[DOWN]** and **[UP]** buttons or the **D [-]** and **[+]** buttons simultaneously.

Press the **[EXIT]** button to return to the normal screen.

2. Stop the metronome.
Press the **METRONOME [ON/OFF]** button.

TIP

The default tempo is 120.
(If a song has been selected, the song tempo is used.)

TIP

You can set the time signature, metronome volume, and metronome tone using the **METRONOME [SETTING]** button.
(See page 76.)

Recording Your Performance

This chapter explains how to record your performance using the Clavinova recording function.

You can, for example, play back what you have played on the Clavinova keyboard for an effective practice aid. You can also record just the left-hand part, then practice the right-hand part while playing back the recorded left-hand part.

Since you can record up to sixteen parts separately, you could record the left- and right-hand parts separately, or record each part of a four-handed performance or ensemble song one by one to build a song.

TIP

You can record your performance (audio data) to a cassette tape recorder or other recording devices via the AUX OUT connector. (see page 61.)

TERMINOLOGY

Recording vs. Saving:

The format of performance data recorded on a cassette tape differs from that of data recorded on the Clavinova. A cassette tape records audio signals. On the other hand, the Clavinova “saves” information regarding note timing, voices, and a tempo value, but not audio signals. When you play back recorded songs, the Clavinova produces sound based on the saved information. Therefore, recording on the Clavinova may be more accurately called “saving information.” However, this book often uses the word “recording” because it seems to make more sense.

A message (information or confirmation dialog) sometimes appears on the screen to facilitate operation. Refer to the “Message List” on page 95 for an explanation of each message, appropriate actions to take, and troubleshooting information.

Recording a New Song

There are two ways to record your performance: recording it quickly without specifying a recording part, or recording several different parts to multiple parts. You can select whichever way best suits your purpose.

■ Recording a performance without specifying the recording part (page 37)

This convenient and simple recording method lets you quickly record your performance without specifying the recording parts—useful, for example, in recording solo piano pieces.

In this way, the performance is automatically recorded to part 1 (right part).

■ Recording a performance of several different parts (page 41)

This lets you record the right, left and extra parts separately. Since you can record the left part while playing back the right, this is useful for recording both parts of a duet. Since you can record up to sixteen parts separately, record the performance of each instrument part one by one and create fully orchestrated compositions.

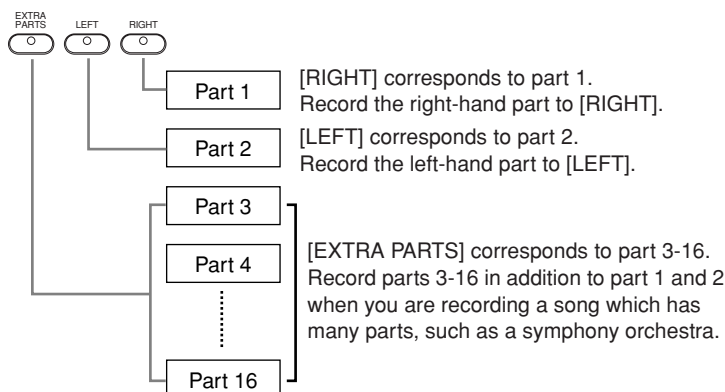

TIP

Appropriate channels (parts) in the song will automatically be assigned to [RIGHT] and [LEFT]. Therefore, [RIGHT] may be assigned to a part other than Part 1, or [LEFT] to a part other than Part 2.

Recording a performance without specifying the recording part

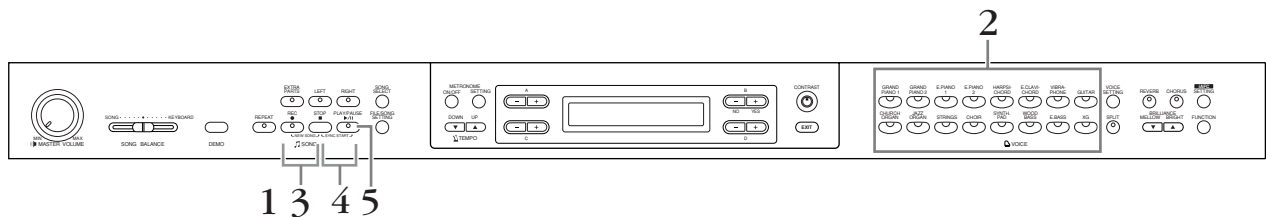

Procedure

1. Select "NewSong" for recording.

Press the [REC] and [STOP] buttons simultaneously.

"NewSong" screen

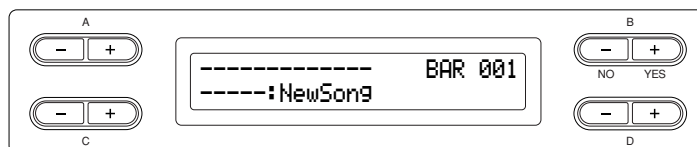

2. Select a voice.

Select a voice (or voices) for recording (see page 27).

Set the other parameters, such as reverb, chorus and Song Balance. Adjust the [MASTER VOLUME] dial to set the volume level to suit your preference. You can also use the dial to adjust the level during playback.

After you set the tempo or if the record standby screen does not appear, press the [SONG SELECT] button once to return to the "NewSong" screen.

3. Engage the record mode.

Press the [REC] button.

The [REC] and [RIGHT] indicators flash in red. (To stop recording, press the [REC] button again or press the [STOP] button.)

Record standby screen

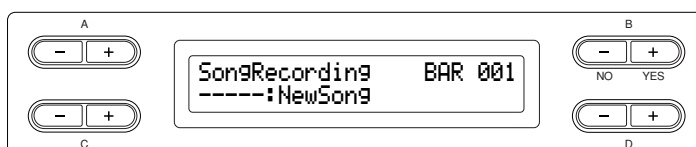

Set the tempo, if necessary.

If this record standby screen does not appear, press the [SONG SELECT] button once.

TIP

If you select a song other than "-----:NewSong" and record on a part that already has data, the existing data on the part will be lost.

TIP

Set the tempo in Step 3.

TIP

See page 44 for more information on recording in Dual/Split mode.

4. Start and stop recording.

Recording begins automatically as soon as you play a note on the keyboard.

(Optional) Press the [PLAY/PAUSE] button to start recording. The recording screen displays the current measure number.

Record screen

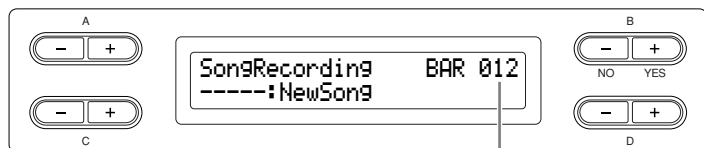

Measure number in recording

To stop recording, press the [STOP] button. The Clavinova locates the top of the song.

As soon as recording is stopped, the song is automatically saved to Storage memory (page 45). When saving is completed, the Storage memory screen appears.

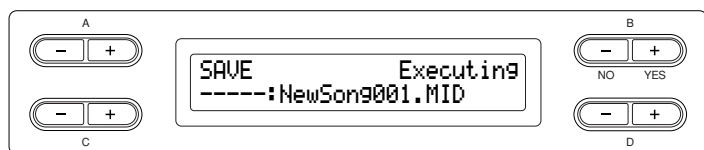

5. Play back the recorded performance.

Press the [PLAY/PAUSE] button to play back the recorded performance.

When playback is complete, it automatically stops and the Clavinova locates the top of the song. To stop playback in the middle of a song, press the [STOP] button. You can also pause playback by pressing the [PLAY/PAUSE] button.

TIP

Using the metronome

You can record data while using the metronome. To do this, turn the metronome on before step 4. The metronome is not recorded.

TIP

To stop recording in the middle of a song, press the [PLAY/PAUSE] button. To resume recording, press the [PLAY/PAUSE] button again or play a note on the keyboard.

TIP

When you press the [REC] button, recording pauses. To return the location to the start of the song, press the [REC] button, again.

TIP

Rename songs

The recorded songs are named automatically, but you can rename songs as you like (page 50).

Re-recording a song partially

This section explains how to record part of a song again.

Procedure

1. Select a recording method.

1-1 Press the [FILE/SONG SETTING] button.

1-2 Press the A [-][+] buttons to display "RecStart" or "RecEnd."

1-3 Press the D [-][+] buttons to specify how the recording should start and end.

Starting methods:

Normal: The existing data will be erased after re-recording starts.

FirstKeyOn: Data that exists prior to the point where you start playing a note will not be erased.

Ending methods:

Replace: The data after the point you stop recording will also be erased.

PunchOut: The data after the point you stop recording will remain.

2. Pause the song at the beginning of the part you wish to re-record.

Use the B [-][+] buttons while the playback screen is displayed to move through the measures or play back the recording and press the [PLAY/PAUSE] button to locate a point slightly prior to the beginning of the part you wish to re-record.

If the playback screen is not displayed, press the [SONG SELECT] button once.

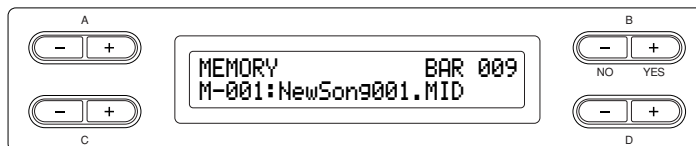

3. Select a voice or voices for recording, if necessary.

Repeat Step 2 on page 37 if you wish to change the previous settings.

4. Engage record mode.

Press the [REC] button.

To stop recording, press the [REC] button again or press the [STOP] button. After pressing the [REC] button again or the [STOP] button when “RecStart” is set to “Normal” (page 39), “Overwrite?” is shown in the display. To cancel this and not overwrite, press the B [- (NO)] button.

5. Start and stop recording.

Recording begins automatically as soon as you play a note on the keyboard.

(Optional) Press the [PLAY/PAUSE] button to start recording.

To stop recording, press the [STOP] button. The Clavinova locates the top of the song.

6. Save the recorded songs.

When you stop recording, the display prompts you whether you want to overwrite the song or not. Press the B [+ (YES)] button to overwrite the song.

To cancel overwriting, press the B [- (NO)] button.

Recording a performance of several different parts

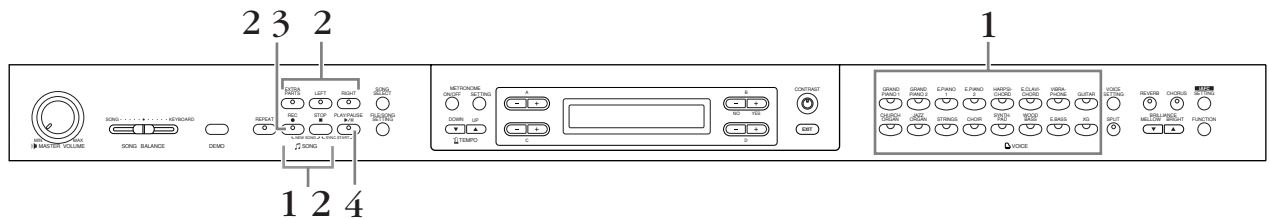

Procedure

- 1. Select “New Song” and a voice for recording.**
 Follow the same operation steps as in “Recording a performance without specifying the recording part” above. Refer to steps 1-2 on page 37.

- 2. Specify the recording parts and engage the record mode.**

Record to the right (part 1) or left (part 2) part:

Press and hold down the [REC] button and press the [RIGHT]/[LEFT] button.

Record to the extra parts (part 3-16):

Press the [FILE/SONG SETTING] button and press the A [-][+] button to display “RecExtraPartsCh.” Press the D [-][+] buttons to specify a recording part. The specified part is assigned to the [EXTRA PARTS] button.

After specifying the recorded part to the [EXTRA PARTS] button, press and hold down the [REC] button and press the [EXTRA PARTS] button.

The [REC] and specified part indicators flash in red.
 (To stop recording, press the [REC] button again or press the [STOP] button.)

Record standby screen

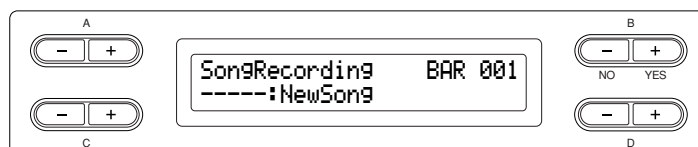

Set the tempo, if necessary.

If this record standby screen does not appear, press the [SONG SELECT] button once.

If you don't want to hear the right/left part while you record, press the [RIGHT]/[LEFT] button so that its indicator is turned off.

TIP

Set the tempo in Step 2.

TIP

See page 44 for more information on recording in Dual/Split mode.

3. Start and stop recording.

Recording begins automatically as soon as you play a note on the keyboard.

(Optional) Press the [PLAY/PAUSE] button to start recording. To stop recording, press the [STOP] button. The Clavinova locates the top of the song.

To stop recording, press the [STOP] button. The Clavinova locates the top of the song.

As soon as recording is stopped, the song is automatically saved to Storage memory (page 45). When saving is completed, the Storage memory screen appears.

Other recording techniques

Adding data to or recording over an existing song

The previous section explains how to record your performance from the beginning by selecting a blank “-----: NewSong.” You can also add your performance to or overwrite existing songs (such as 50 preset songs [P-001—P-050], commercially-available music data <see page 59>, or your old recorded performances <see page 45>).

Procedure

1. Select a song to be recorded over.

To select a preset song, press the [SONG SELECT] button, then press the A [-][+] buttons to display “PRESET.” To select a song, press the C [-][+] buttons.

To select a song from commercially available music data or from already-recorded data, press the A [-][+] buttons to display “MEMORY” or “USB1” in the Song Select screen and press the C [-][+] buttons.

To continue recording, follow the procedure described in “Recording a performance without specifying the recording part” from pages 37 to 36.

When you record over a preset song, the song is automatically saved to Storage memory (page 45) when the recording stopped.

When you record over a song of commercially available music data or of already-recorded data, the display prompts you whether you want to overwrite the song or not (when recording is stopped). Press the B [+ (YES)] button to overwrite the song.

TIP

If you record on a part that already has data, the existing data on the part will be lost.

Changing a voice or tempo after recording

You can change the voice and tempo after recording to change a song's feel or to set a more suitable tempo. You can also change these elements in the middle of a song.

Procedure

1. Select a song you wish to change (page 42).
2. To change the voice or tempo in the middle of the song, specify the measure to change by using the **B [-][+]** buttons while the playback screen is displayed or by pressing the **[PLAY/PAUSE]** button to locate a point slightly prior to the beginning of the part you wish to re-record.
3. Change the settings (voice, reverb, etc.).
For example, if you wish to change the recorded E.Piano1 voice to E. Piano2, use the voice group buttons and the **A [-][+]** buttons to select E.Piano2.
When the setting is complete, press the **[SONG SELECT]** button once to return to the song select screen.
4. Press and hold down the **[REC]** button and select the part to change.
The indicator for the selected part lights up in red.
Change the tempo setting now, if necessary.

At this point, do not play the keyboard or press the **[PLAY/PAUSE]** button. Otherwise, recording will start, erasing the recorded data.
5. Press the **[STOP]** or **[REC]** button to exit record mode.
When you exit record mode, the display prompts you whether you want to overwrite the song or not. Press the **B [+ (YES)]** button to overwrite the song.

TIP

Before changing a voice or tempo, set the starting method to "Normal." (page 39)
When the starting method is set to "FirstKeyOn," you cannot change a voice or tempo.

TIP

Refer to "Questions about Operations and Functions" on page 101 for information on the settings that can be changed here.

TIP

Change the tempo in Step 4.

CAUTION

The panel settings on Step 3 will be saved in memory and you will not be able to restore the previous settings. Proceed with caution.

Adjusting the volume balance between playback and your performance [SONG BALANCE]

While recording multiple parts one by one, you can adjust the volume balance between the playback of the recorded parts and your current performance.

Procedure

1. Move the [SONG BALANCE] slider to the left or right to make adjustments.

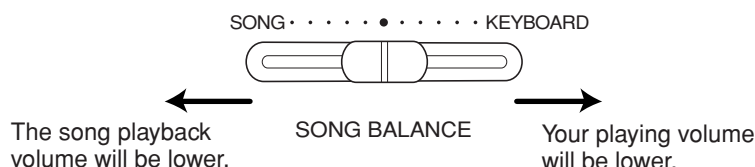

TIP

Some commercially-available music data contains extremely high volumes. When using such data, please adjust the song balance.

Recording in Dual or Split mode

When you record in Dual or Split mode, the Clavinova records each voice onto a separate part. The following table shows how parts are assigned to each voice.

⚠ CAUTION

When you record multiple parts one by one, or when you record new data over an existing song (see page 42), the existing data will be erased. Proceed with caution.

In the following example, RIGHT, LEFT, and EXTRA PARTS n have been selected for recording.

Parts assigned for recording	Dual			Split			Split+Dual		
	RIGHT	LEFT	EXTRA PART n	RIGHT	LEFT	EXTRA PART n	RIGHT	LEFT	EXTRA PART n
	↓	↓	↓	↓	↓	↓	↓	↓	↓
Parts used for recording	MAIN (voice 1)	Part 1	Part 2	Part n	Part 1	Part n	Part 1	Part n	
	LEFT (voice 1)	-			Part 2	Part n+1	Part 2	Part n+1	
	MAIN (voice 2)	Part 3	Part 4	Part n+2	-		Part 3	Part n+2	
	LEFT (voice 2)	-			-		Part 4	Part n+3	

Note: Part n = Part 3 – Part 16
If “n+1,” “n+2,” and “n+3” exceed 16, Parts 1, 2, and 3 are used.

TIP

Switching between Dual and Split mode in a song is not recorded.

Handling files such as deleting song files ... [FILE/SONG SETTING]

File screens (accessed via the [FILE/SONG SETTING] button) enables you to handle files (e.g., save, delete and rename recorded songs), copy and format medias and change characters on the screen.

The following parameters are provided for these operations:

Settings	Parameter name	Reference page
Saving recorded songs to a USB storage device	Save	48
Deleting a song from the Clavinova's Storage memory or from a USB storage device	Delete	49
Renaming files	Rename	50
Copying files	Copy	51
Moving files	Move	53
Making folders (directories) in the USB storage device	MakeDir	54
Formatting a USB storage device	Format	54
Automatically selecting a song in storage media	SongAutoOpen	55
Changing the type of characters on screen	CharCode	55

Clavinova memory

The Clavinova has the following three types of memory:

- **Current memory:**
This is a temporary memory area where you can temporarily place and edit the currently-selected song before playback or recording.
- **Preset song memory:**
This read-only memory area saves 50 piano preset songs.
- **Storage memory:**
This memory area enables you to save recorded songs or song data loaded from USB storage device.

When you select a song in the song select screen, it is loaded from Preset song memory, Storage memory, or USB storage device, into Current memory. You will use Current memory to play back and record songs. When you turn off the power to the Clavinova, songs saved in Preset song memory and Storage memory are not erased. On the other hand, songs in Current memory are lost. However, recorded songs are automatically saved to Storage memory from Current memory.

In this manual, a song located in a song recorded in Current memory, is referred to as a “**Current song**,” a song in Storage memory is a “**Memory song**,” and a song on a USB storage device is an “**External song**.”

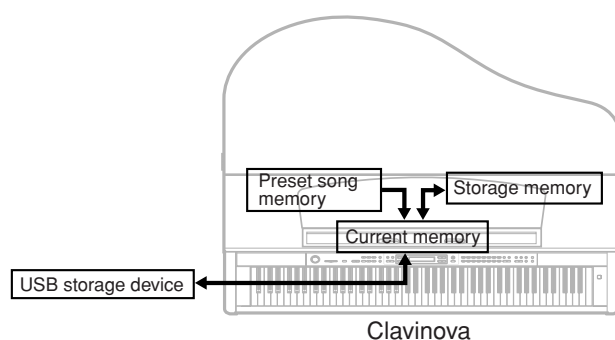

TERMINOLOGY

File

A file contains a group of data. On the Clavinova, a song file includes song data and a song number.

Memory

Memory is a location inside the Clavinova in which you can save and edit data.

Character code

Type of characters

TIP

Please note that the copy features are intended for your personal use only.

Song types

This instrument handles various types of songs. Letters and song numbers are displayed to the left of the song name. The letters indicate the different song types as follows:

- PPreset songs
- M.....Memory songs
- MP.....Protected songs such as preset songs saved to Storage memory, or Disk Orchestra Collection (DOC) songs, and Disklavier Piano Soft songs in the Storage memory.
- MS, MsYamaha-protection-formatted songs in the Storage memory.
- U1.....External song
- U1PExternal songs such as Disk Orchestra Collection (DOC) songs or Disklavier Piano Soft songs in a USB storage device.
- U1S, U1sYamaha-protection-formatted songs in a USB storage device.

Limitation of file operations

O: Yes X: No

	Song types			
	P	M, U1	MP, U1P	MS, Ms, U1S, U1s
Save	○ ^{*1}	○	○ ^{*1}	×
Delete	×	○	○ ^{*2}	○
Rename	×	○	○ ^{*2}	○
Copy	○ ^{*1}	○	○ ^{*1}	×
Move	×	○	×	○ ^{*3}

*1 Only to Storage memory

*2 Only MP songs

*3 Only between Storage memory and USB storage memory

TIP

U1 song with the ".SME" extension can only be deleted — cannot execute other file operations at left.

Basic file operation

A message (information or confirmation dialog) sometimes appears on the screen to facilitate operation. Refer to the “Message List” on page 95 for an explanation of each message, appropriate actions to take.

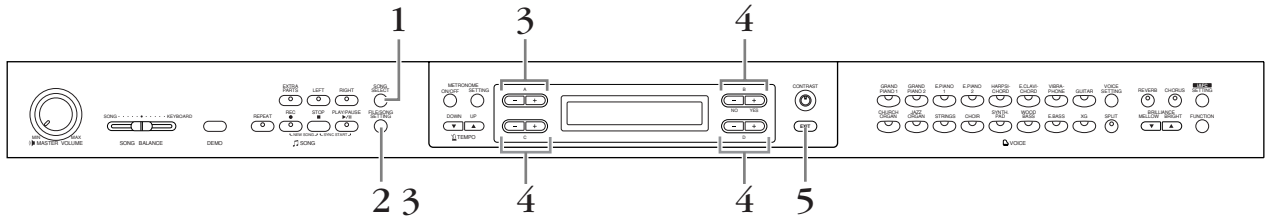

Procedure

1. Prepare for handling file(s).

Prepare for handling files as follows.

To use “Save,” “Rename,” “Copy” or “Move”:

Select a song via the [SONG SELECT] button.

To use “MakeDir”:

Select the USB storage device via the [SONG SELECT] button.

To use “Delete,” “Format,” “SongAutoOpen” or “CharacterCode”:

No need to perform any operations in this step.

2. Access the File/Song Setting menu.

Press the [FILE/SONG SETTING] button.

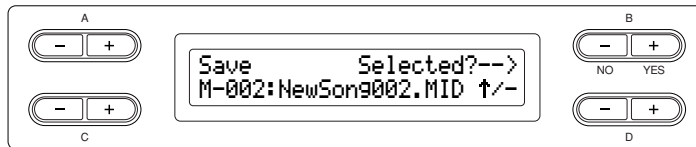

To close the File/Song Setting menu, press the [EXIT] button once or twice.

3. Select the desired parameter.

Press the [FILE/SONG SETTING] or A [-][+] buttons repeatedly to display the desired item.

4. Set the parameter or execute the command.

Use the B [- (NO)][+ (YES)], C [-][+], D [-][+] buttons.

For more information regarding this procedure, refer to the corresponding section below.

5. Close the File/Song Setting menu.

Press the [EXIT] button.

TIP

If a folder is displayed for an External song, the [↑/↓] indicator is displayed in the lower right of the screen. In this case, you can use the D [+] button to open the folder. Press the D [-] button to return to the previous (upper) level.

CAUTION

Avoid frequently turning the power on/off to the USB storage device, or connecting/disconnecting the cable too often. Doing so may result in the operation of the instrument “freezing” or hanging up. While the instrument is accessing data (such as in the Save, Copy and Delete operations), do NOT unplug the USB cable, do NOT remove the media from the device, and do NOT turn the power off to either device. Doing so may corrupt the data on either or both devices.

TERMINOLOGY

“Overwrite?→”: Do you wish to overwrite the song?
 “Execute?→”: Do you wish to execute the operation?
 “Sure?→”: Are you sure?
 “Executing”: The Clavinova is executing the operation.
 “Completed”: The operation is complete.

Saving recorded songs to a USB storage device ... [Save]

Recorded songs are automatically saved to Storage memory from Current memory, so normally you won't need to save songs using this function. However, if a "MemoryFull" message or "SystemLimit" message appear, save the song to another device using this function.

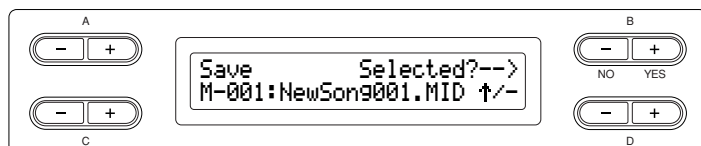

⚠ CAUTION

Do not turn off the power before the save operation is completed. If you turn off the power to the Clavinova before the save operation is completed, the recorded song will be lost.

Procedure

See page 47 for information on basic operations. The following is a detailed procedure of Step 4.

4-1 Select a save destination.

Press the D [-] button to display "DriveSelected?→" and press the C [-][+] buttons to select a save destination (Storage memory or USB storage device). After selecting a save destination, press the B [+ (YES)] button to fix it. Then press the B [+ (YES)] button to display "Execute?→."

4-2 Name the song.

To move the cursor (small underline), use the C [-][+] buttons.
 To insert a space, press the C [-][+] buttons simultaneously.
 To select a character at the cursor, use the D [-][+] buttons.
 To delete a character, press the D [-][+] buttons simultaneously.
 You can use up to 46 one-byte or 23 two-byte characters for a song name. If the name is longer than the screen, use the C [-][+] buttons to move the cursor and scroll the name.

4-3 Execute the operation.

Press the B [+ (YES)] button located next to "Execute?→."
 Follow the instructions on screen.
 The song is automatically numbered.

TIP

If Storage memory contains one or more songs, and you save a new song, the Clavinova automatically sorts the songs alphabetically and rennumbers them.

TIP

If a folder is displayed for an External song, the [↑/↓] indicator is displayed in the lower right of the screen. In this case, you can use the D [+] button to open the folder. Press the D [-] button to return to the previous (upper) level.

TIP

You can change the type of characters on the screen using the "CharacterCode" parameter.

⚠ CAUTION

Do not turn off the power or eject the media while "Executing" is shown in the display.

Deleting a song from the Clavinova's Storage memory or from a USB storage device ... [Delete]

This deletes a song from Storage memory or from a USB storage device. It is not possible to delete a preset song or current song.

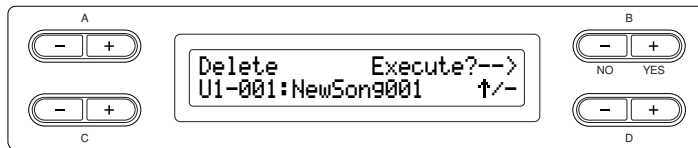

Procedure

See page 47 for information on basic operations. The following is a detailed procedure of Step 4.

4-1 Press the C [-][+] buttons to select a song to delete.

To select Storage memory or USB storage device:

Press the D [-] button to display “DriveSelected?→” and press the C [-][+] buttons to select Storage memory or USB storage device. Then, press the B [+ (YES)] button or D [+] button to display the content of the Storage memory or USB storage device and select a song by pressing the C [-][+] buttons.

4-2 Press the B [+ (YES)] button located next to “Execute?→.”

Follow the instructions on screen.

TIP

After you delete a song, the Clavinova automatically updates the song numbers.

TIP

When you delete a folder, all files within that folder will be deleted.

TIP

If a folder is displayed for an External song, the [↑/↓] indicator is displayed in the lower right of the screen. In this case, you can use the D [+] button to open the folder. Press the D [-] button to return to the previous (upper) level.

CAUTION

Do not turn off the power or eject the media while “Executing” is shown in the display.

Renaming files ... [Rename]

You can change a song's title except for the preset songs and [-----: NewSong].

Procedure

See page 47 for information on basic operations.

The following is a detailed procedure for Step 4.

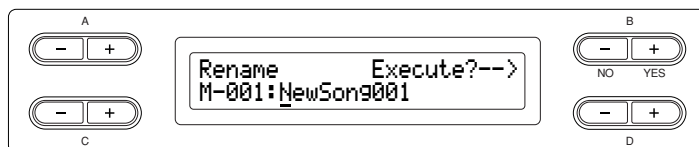

4. Name the song as described in the "Save" section (page 48).

CAUTION

Do not turn off the power or eject the media while "Executing" is shown in the display.

TIP

To rename folders

To rename a folder, select "Rename" then select the folder by pressing the [SONG SELECT] button and the C [-] [+] buttons. (The folder name is shown after "DIR:.") To select another level in this display, press the D [-][+] buttons. (Other levels can be selected when "↑/↓" is shown in the display.) After that, select "Rename" again and rename the folder.

TIP

After you rename a song, the Clavinova sorts songs alphabetically and renumbers them.

Copying files ... [Copy]

You can copy songs. However, you cannot copy files to the same root directory or same folder.

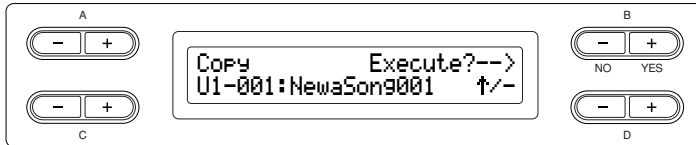

Copy operation

You can copy files to other memory location.

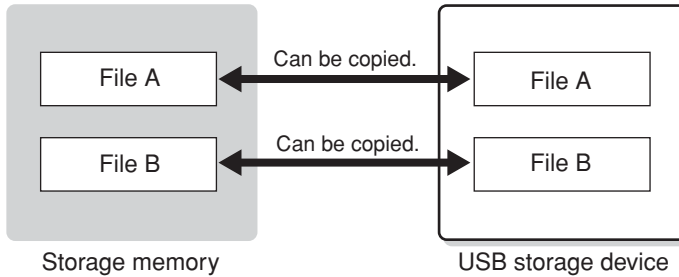

You can copy files to a folder but not on the same root directory.

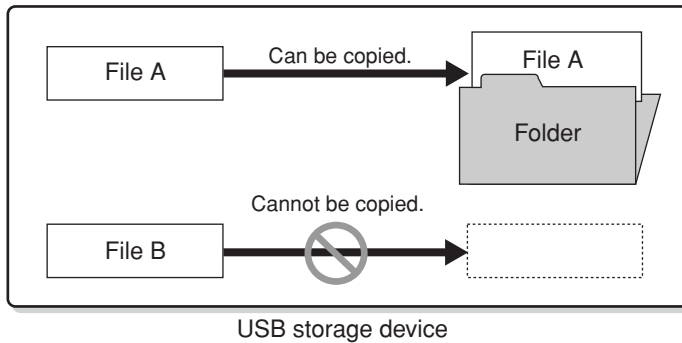

TIP

Please note that the copy features are intended for your personal use only.

TERMINOLOGY

Root:

The highest level of a hierarchical structure. This indicates an area which does not belong to a folder.

Procedure

See page 47 for information on basic operations. The following is a detailed procedure for Step 4.

- 4-1** When you copy a song to/from a USB storage device, make sure that a USB storage device is connected to the instrument.
- 4-2** Press the D [-] button to display "DriveSelected?→" and press the C [-][+] buttons to select a copy destination (Storage memory or USB storage device). After selecting a copy destination, press the B [+ (YES)] button to fix it.
- 4-3** Press the B [+ (YES)] button located next to "Execute?→."
Follow the instructions on screen.

TIP

Protected songs cannot be copied.

TIP

Please note that the copy features are intended for your personal use only.

TIP

You cannot copy a folder.

TIP

If a folder is displayed for an External song, the [↑/↓] indicator is displayed in the lower right of the screen. In this case, you can use the D [+] button to open the folder. Press the D [-] button to return to the previous (upper) level.

⚠ CAUTION

Do not turn off the power or eject the media while "Executing" is shown in the display.

Moving files ... [Move]

You can move (cut and paste) songs.

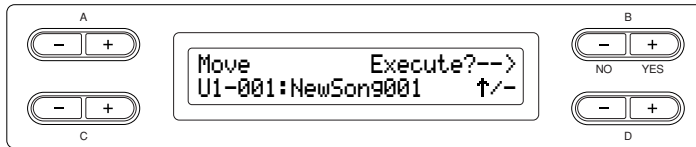

Procedure

See page 47 for information on basic operations. The following is a detailed procedure for step 4.

- 4-1** When you move a song to/from a USB storage device, make sure that a USB storage device is connected to the instrument.
- 4-2** Press the D [-] button to display "DriveSelected?→" and press the C [-][+] buttons to select a move destination (Storage memory or USB storage device). After selecting a move destination, press the B [+ (YES)] button to fix it.
- 4-3** Press the B [+ (YES)] button located next to "Execute?→."
Follow the instructions on screen.

TIP

Preset songs and some protected songs cannot be moved.

TIP

You cannot move a folder.

TIP

If a folder is displayed for an External song, the [↑/↓] indicator is displayed in the lower right of the screen. In this case, you can use the D [+] button to open the folder. Press the D [-] button to return to the previous (upper) level.

CAUTION

Do not turn off the power or eject the media while "Executing" is shown in the display.

Making folders in the USB storage device ... [MakeDir]

You can create folders (directories) on the USB storage device to organize songs. This instrument enables you to create folders only in the USB storage device—not in the Preset song memory and Storage memory.

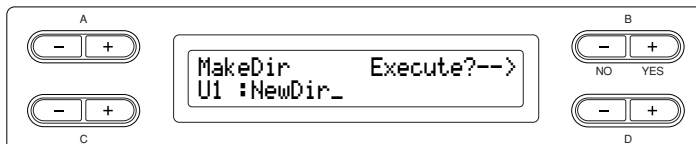

⚠ CAUTION

Do not turn off the power or eject the media while "Executing" is shown in the display.

TIP

To make a folder for the selected drive or level

To make a folder for the selected drive or level, select "MakeDir" then select "USB" by pressing the [SONG SELECT] button. In this display, press the A [-][+] button to select another drive. Press the D [-][+] button to select another level. After that, select "MakeDir" again and make a folder, following step 4 at left.

TERMINOLOGY

Root:

The highest level of a hierarchical structure. This indicates an area which does not belong to a folder.

Procedure

See page 47 for information on basic operations. The following is a detailed procedure for step 4.

4-1 Follow the steps "Saving recorded songs to a USB storage device" on page 48 to name the folder.

4-2 Press the B [+ (YES)] button located next to "Execute?→."

Follow the instructions on screen.

The folder is created in the root directory in the USB1 (indicated by "U1" in this display) device.

Formatting a USB storage device ... [Format]

You can format media so that it can be used with the Clavinova.

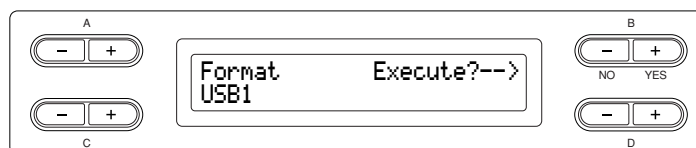

Procedure

See page 47 for information on basic operations. The following is a detailed procedure for step 4.

4-1 If some USB storage devices are recognized by the instrument, press the C [-][+] buttons to select a device.

4-2 Press the B [+ (YES)] button located next to "Execute?→."

Follow the instructions on screen.

⚠ CAUTION

Do not turn off the power or eject the media while "Executing" is shown in the display.

TIP

For a list of devices whose compatibility has been confirmed by Yamaha, visit the following web page:
<http://music.yamaha.com/CLP-295GP/>

Automatically selecting a song in storage media ... [SongAutoOpen]

Specify whether a song (not contain in a folder) which does not contain to a folder will automatically be opened when you insert the media.

TIP

When a USB storage device is connected to the instrument, a song in the device will not automatically open. A song is automatically opened only when media is inserted to a drive. Therefore, this function cannot be used for devices which do not use removable media — such as USB flash memory or hard disk drive.

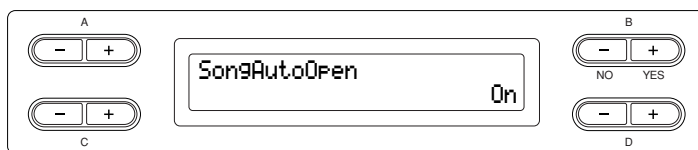

Procedure

See page 47 for information on basic operations. The following is a detailed procedure for step 4.

- 4 Use D [-][+] button to select ON or OFF.

Changing the type of characters on screen ... [CharacterCode]

You can change the type of characters that appear on screen. The default setting is “International.” To input katakana, change this setting to “Japanese.”

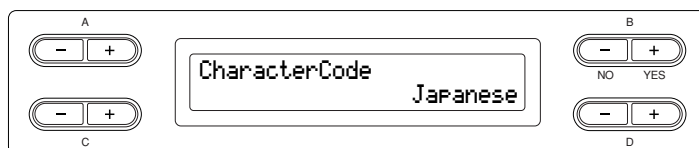

Options: International, Japanese

Character list

International

0~9	A~Z	a~z	Ä	Ë	Ï	Ö	Ü	ä	ë	ï	ö	ü	à	è	ì	ò	ù	á	é	í	ó	ú	â	ê	î	ô	û	Ñ	ñ	ß	Ç	ç	°	ı	ı	!	#	\$	%	&	'	()
+	,	-	.	;	=	@	[]	^	_	`	{	}	~																													

Japanese

0~9	A~Z	a~z	ア	ン	ア	オ	ヤ	ユ	ヨ	ツ	ッ	°	ー	。	「	」	,	・	!	#	\$	%	&	'	()	+	,	-	.	;	=	@	[]	^	_	`	{	}	~
-----	-----	-----	---	---	---	---	---	---	---	---	---	---	---	---	---	---	---	---	---	---	----	---	---	---	---	---	---	---	---	---	---	---	---	---	---	---	---	---	---	---	---

Playing Back Recorded Songs and Commercially-available Music Data

You can play back songs recorded using the Record function (page 36) as well as commercially-available music data. You can also play the keyboard along with the playback.

TIP

Songs containing a large amount of data may not be able to be read properly by the instrument, and as such you may not be able to select them. The maximum capacity is about 200–300KB, however this may differ depending on the data contents of each song.

TIP

See page 59 for information on the types of song data that can be played on the Clavinova.

TIP

Change the Clavinova's character type ([CharacterCode]) as appropriate for the selected song (page 55).

Playing back a song

If you want to play back an External song on this instrument, connect the USB storage device and insert the appropriate media into the device.

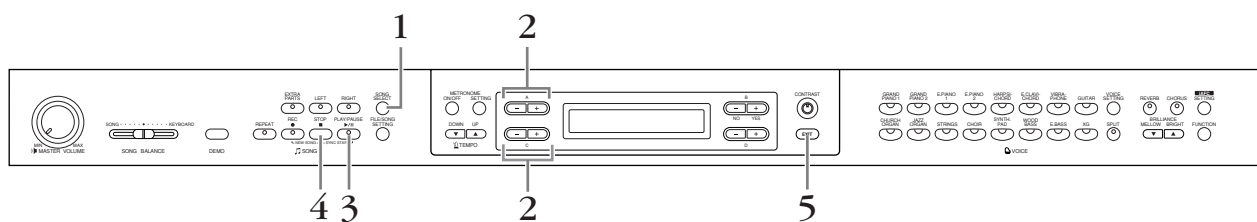

Procedure

1. Display the song select screen.

Press the [SONG SELECT] button.

Song select screen

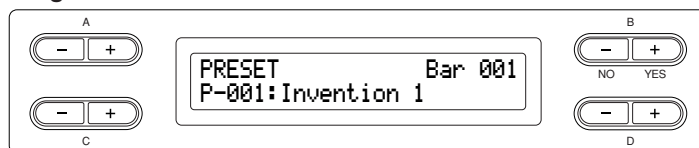

2. Select the desired song.

TIP

You can enjoy ensemble performance by yourself. Record the parts for a four-handed song or a piano duet, then play the recorded part while playing the other part on the keyboard.

TIP

You can repeat playback a single song via the [Repeat] button (page 25) or repeat playback all songs by using the "SongRepeat" function (page 73).

TIP

If a folder is displayed for an External song, the [↑/↓] indicator is displayed in the lower right of the screen. In this case, you can use the D [+] button to open the folder. Press the D [-] button to return to the previous (upper) level.

TIP

If the song name extends beyond what can be displayed in the screen, you can press the D [+] button to move toward the right in steps of one character. Press the D [-] button to move back to the left in steps of one character.

2-1 Use the A [-][+] buttons to select the song type: "PRESET," "MEMORY," or "USB1."

PRESETStands for Preset song memory. This memory contains 50 piano preset songs.

MEMORY...Stands for Storage memory. This memory contains recorded songs or copied songs. "MEMORY" is not displayed when this memory does not contain any songs.

USB1Stands for USB storage device. This device contains commercially available song data, etc. "USB1" is not displayed when the USB storage device is not connected to the instrument. When several USB storage devices are recognized to the instrument, numbers are added after "USB," like "USB1," "USB2"... The numbers are not fixed and may change according to the order in which the devices are connected and disconnected.

2-2 Use the C [-][+] or [SONG SELECT] button to select a song.

Letters (page 46) and song numbers are displayed on the left of the song names.

3. Start playback.

Press the [PLAY/PAUSE] button.

Starting playback automatically as you start playing the keyboard (Sync Start)

You can start playback as soon as you start playing the keyboard. This is called the "Sync Start" function.

To enter Sync Start standby mode, press and hold down the [STOP] button and press the [PLAY/PAUSE] button. The [PLAY/PAUSE] indicator flashes. Now play the keyboard. Playback starts simultaneously.

To cancel the Sync Start function, press the [STOP] button while the Clavinova is in Sync Start standby mode.

You can move back and forth (rewind and fast forward) through the bars by using the B [-][+] buttons in the song select screen while the Clavinova is playing or stopped.

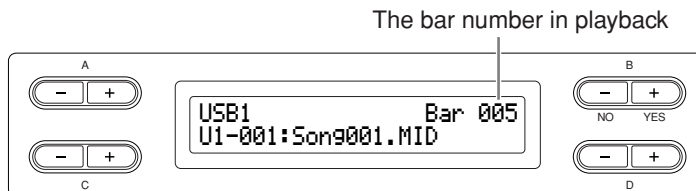

You can play the keyboard while the Clavinova is playing back a song. You can also play the notes in a voice different from the playback voice by selecting the voice from the panel, and adjusting the volume balance between the playback parts and your current performance using the [SONG BALANCE] slider. (See page 44.)

Press the [SONG SELECT] button to return to the song select screen.

TERMINOLOGY

Bar: measure

TIP

You can play the metronome along with the song playback. When you stop playback, the metronome is also stopped.

TIP

Press the C [+] button during playback to start playback from the next song. Press the C [-] button during playback to start playback from the previous song.

Adjusting the tempo

You can use the TEMPO [DOWN][UP] buttons to adjust the playback tempo as required before or during playback. The default tempo (the song's original tempo) is set when you press the [DOWN] and [UP] buttons simultaneously.

Press the [SONG SELECT] button to return to the song select screen.

4. Stop playback.

When playback is complete, the Clavinova automatically stops and locates the top of the song. To stop playback in the middle of a song, press the [STOP] button. You can also pause playback by pressing the [PLAY/PAUSE] button. Playback pauses when you press the button.

5. Return to the main screen.

Press the [EXIT] button.

Turning part playback on and off

While the Clavinova is playing or stopped, pressing these part buttons turn off the indicators, and the data on those parts will not be played. Pressing the part buttons toggles part playback on and off. You can play the part that is turned off.

TIP

You can practice a part or phrase using the “SongRepeat (page 73)” and “PhraseMark (page 73)” parameters in the “FILE/SONG SETTING” menu.

TIP

Appropriate channels (parts) in the song will automatically be assigned to [RIGHT] and [LEFT]. Therefore, [RIGHT] may be assigned to a part other than Part 1, or [LEFT] to a part other than Part 2.

Supported song data type

Data formats that can be played on the CLP-295GP

The Clavinova CLP-295GP plays song data in the following formats:

Sequence format

- SMF (Standard MIDI File) formats 0 and 1
- ESEQ

Performance data recorded on the CLP-295GP is saved as SMF format 0.

Voice arrangement format

- XG voice arrangement
- GM system level 1 voice arrangement
- GM system level 2 voice arrangement
- DOC voice arrangement

Performance data recorded with preset XG voices on the CLP-295GP can be played on other XG-compatible instruments. See the separate “Data List” for the XG voice list.

Floppy disk format

- 3.5-inch 2DD disks in the MS-DOS 720KB format
- 3.5-inch 2HD disks in the MS-DOS 1.44MB format

Refer to “Data compatibility” on page 106 for more information on formats.

TERMINOLOGY

Sequence format:

A structured method for recording performance data.

TERMINOLOGY

Voice arrangement format:

A structured method for numbering the voices for assignment.

TIP

This instrument can play GS format songs. However, the voices may not be completely the same as used in the original.

TERMINOLOGY

Disk format:

A structured method for writing data to disk.

Connections

Connectors

⚠ CAUTION

Before connecting the Clavinova to other electronic components, turn off the power to all the components. Before turning the power on or off to all components, set all volume levels to minimum (0). Otherwise, electrical shock or damage to the components may occur.

on the left of the panel

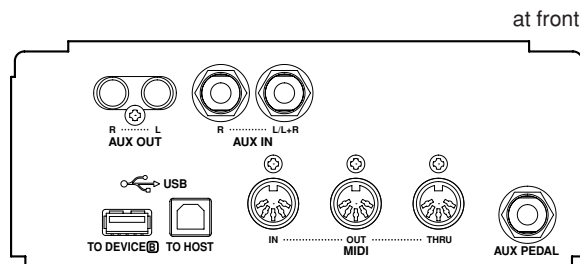
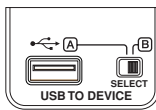

1 USB [TO DEVICE] terminal (A/B)

This terminal allows connection to USB storage devices. Refer to “Connecting to a USB storage device” on page 62.

2 USB [TO HOST] terminal

This terminal allows direct connection to a personal computer. Refer to “Connecting a personal computer” on page 65 for more information.

3 MIDI [IN], [OUT], [THRU] terminals

Use MIDI cables to connect external MIDI devices to these connectors.

MIDI [IN]: Receives MIDI data.

MIDI [OUT]: Transmits MIDI data.

MIDI [THRU]: Transmits data received at the MIDI [IN] terminal as it is.

About MIDI

MIDI (Musical Instrument Digital Interface) is a standard format for data transmission/reception. It enables the transfer of performance data and commands between MIDI devices and personal computers. Using MIDI, you can control a connected MIDI device from the Clavinova, or control the Clavinova from a connected MIDI device or computer.

4 [AUX PEDAL] jack

A separately sold FC7 foot controller or FC4/FC5 foot switch can be connected to this jack. By using an FC7 you can control the volume while playing to add expression to your performance, or control various other functions. By using an FC4/FC5, you can switch various selected functions on/off. To select the function that will be controlled, use the [FUNCTION] parameter [Aux-Pedal] (page 88). The [PLAY/PAUSE] function can also be assigned to a foot switch (page 89).

TIP

There are two different types of USB terminals on the instrument: USB [TO DEVICE] and USB [TO HOST]. Take care not to confuse the two terminals and the corresponding cable connectors. Be careful to connect the proper plug in the proper direction.

TIP

MIDI performance data and commands are transferred in the form of numeric values.

TIP

Since MIDI data that can be transmitted or received varies depending on the type of MIDI device, check the “MIDI Implementation Chart” to find out what MIDI data and commands your devices can transmit or receive. The Clavinova’s MIDI Implementation Chart appears on the separate Data List.

⚠ CAUTION

Connect or disconnect the pedal when the power is off.

5 AUX IN [L/L+R], [R] jacks

The stereo outputs from another instrument can be connected to these jacks, allowing the sound of an external instrument to be reproduced via the Clavinova's speakers. Refer to the diagram below and use audio cables for connection.

⚠ CAUTION

When the Clavinova's AUX IN jacks are connected to an external device, first turn on the power to the external device, then to the Clavinova. Reverse this order when you turn the power off.

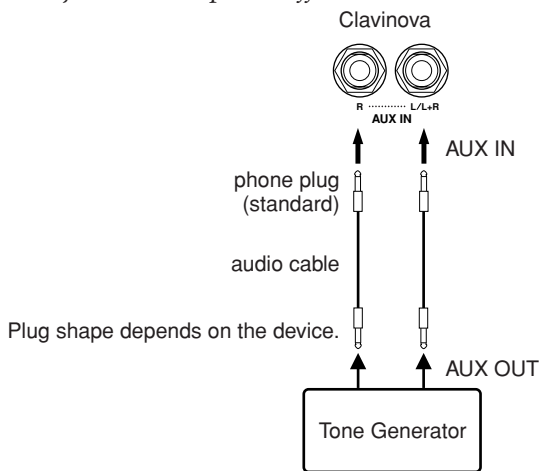

6 AUX OUT [L] [R] Pin jacks

These jacks let you connect the Clavinova to your stereo system etc. to play at higher volumes, or connect a cassette recorder etc. to record your playing. Use audio cables to make connections as shown in the diagram.

⚠ CAUTION

When the Clavinova's AUX OUT jacks are connected to an external audio system, first turn on the power to the Clavinova, then to the external audio system. Reverse this order when you turn the power off.

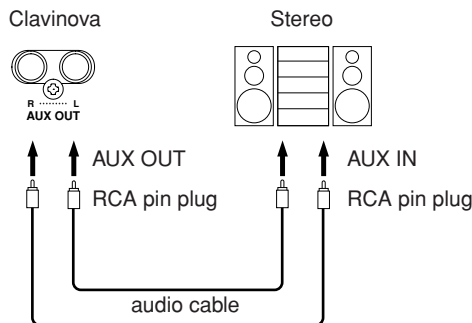

When "AuxOutLevel (page 91)" is set to "Fixed," the sound is output to the external device at a fixed level and the Clavinova's [MASTER VOLUME] setting will not affect the sound.

When "AuxOutLevel (page 91)" is set to "Variable," the Clavinova's [MASTER VOLUME] setting will affect the sound that is output from AUX OUT.

TIP

The Clavinova's [MASTER VOLUME] dial setting affects the input signal from the AUX IN jacks, but the [REVERB], [CHORUS], and BRILLIANCE [MELLOW] [BRIGHT] (page 29) settings do not.

TIP

If you connect the Clavinova to a monaural device, use only the AUX IN [L/L+R] jack.

TIP

Use audio cables and adaptor plugs with no resistance.

TIP

When the sound from the AUX OUT jacks is routed to the AUX IN jacks, the input sound will be output from the speaker of the CLP. The output sound may be excessively loud and may cause noise.

Connecting to a USB storage device

By connecting the instrument to a USB storage device with a standard USB cable, you can save data you've created to the connected device, as well as read data from the connected device.

Compatible USB storage devices

Up to two USB storage devices, such as a floppy disk drive, hard disk drive, CD-ROM drive, flash memory reader/writer, etc., can be connected to the USB [TO DEVICE] terminal. (If necessary, use a USB hub.) Other USB devices such as a computer keyboard or mouse cannot be used.

The instrument does not necessarily support all commercially available USB storage devices. Yamaha cannot guarantee operation of USB storage devices that you purchase. Before purchasing USB storage devices, please consult your Yamaha dealer, or an authorized Yamaha distributor (see list at end of the Owner's Manual) for advice, or visit the following web page:
<http://music.yamaha.com/CLP-295GP/>

CAUTION

Avoid frequently turning the power on/off to the USB storage device, or connecting/disconnecting the cable too often. Doing so may result in the operation of the instrument "freezing" or hanging up. While the instrument is accessing data (such as in the Save, Copy and Delete operations), do NOT unplug the USB cable, do NOT remove the media from the device, and do NOT turn the power off to either device. Doing so may corrupt the data on either or both devices.

TIP

CD-ROM drive

Although CD-R/RW drives can be used to read data to the instrument, they cannot be used for saving data.

TIP

Do not use a non-ID SmartMedia card.

TIP

Number of USB storage devices

Two USB storage devices can be connected to one USB [TO DEVICE] terminal using a hub device. This instrument can recognize up to four drives in one USB storage device.

TIP

About USB hub

If you are connecting two devices at the same time, use a USB hub device. The USB hub must be self-powered (with its own power source) and the power must be on. Only one USB hub can be used. If an error message appears while using the USB hub, disconnect the hub from the instrument, then turn on the power of the instrument and re-connect the USB hub.

TIP

Optional Floppy Disk Drive

Yamaha UD-FD01

Connection to a USB storage device

This instrument has two USB [TO DEVICE] terminals; one on the left of the panel and one on the terminal at the front.

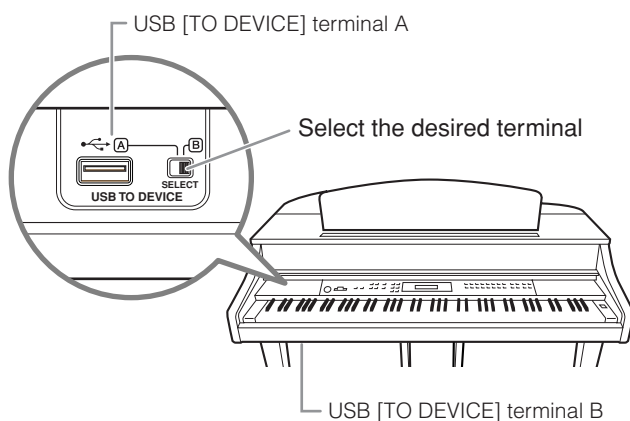

Both are the same terminal; however, both cannot be used at the same time. Use the [SELECT] switch to select the desired terminal. Switching to “A” selects the terminal on the left of the panel, while switching to “B” selects the terminal panel at the front.

⚠ CAUTION

While the instrument is accessing data (such as in the Save, Copy and Delete operations), do NOT use the [SELECT] switch. Doing so may corrupt the media or data.

Formatting USB storage media

When you execute a file-related operation with a connected USB storage device, a message may appear indicating the device/media is unformatted. If so, execute the Format operation (page 54).

⚠ CAUTION

The format operation overwrites any previously existing data. Proceed with caution.

To protect your data (write-protect):

To prevent important data from being inadvertently erased, apply the write-protect provided with each storage device or media. If you are saving data to the USB storage device, make sure to disable write-protect.

To display the data in the USB storage device

To view the data of the USB storage device on the CLP display, press the [SONG SELECT] button to engage song selection mode or press the [FILE/SONG SETTING] button to engage file/song setting mode. If you try to engage these modes before connecting the USB storage device, press the [EXIT] button to exit the mode and re-engage the mode.

TIP

If you connect USB storage devices to both USB [TO DEVICE] terminals, the devices may not operate properly.

TIP

Though the instrument supports the USB 1.1 standard, you can connect and use a USB 2.0 storage device with the instrument. However, note that the transfer speed is that of USB 1.1.

Backing up your data to a computer

■ Backing up the instrument data to a computer

Once you've saved data to a USB storage device, you can copy the data to the hard disk of your computer, then archive and organize the files as desired. Simply reconnect the device as shown below.

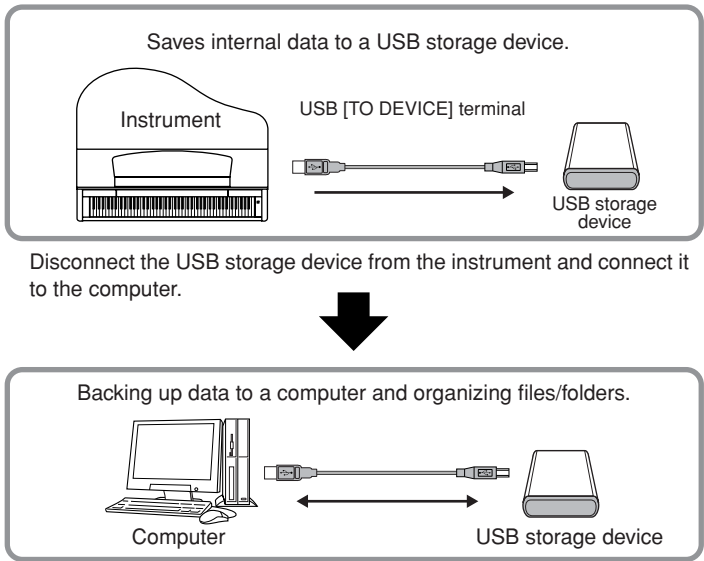

■ Copying files from a computer hard disk to a USB storage device

Files contained on the hard disk of a computer can be transferred to the instrument by first copying them to the storage media, then connecting/inserting the media to the instrument. Not only files created on the instrument itself but also Standard MIDI files created on other devices can be copied to a USB storage device from the hard disk of the computer. Once you've copied the data, connect the device to the USB [TO DEVICE] terminal of the instrument, and play back the data on the instrument.

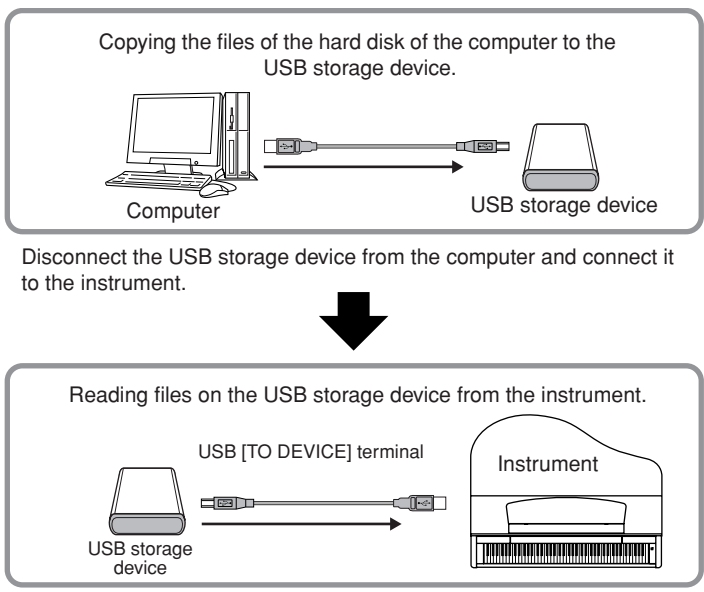

Connecting a personal computer

By connecting a computer to the USB [TO HOST] or MIDI terminals, you can transfer data between the instrument and the computer via MIDI, and take advantage of sophisticated computer music software. Keep in mind that you also need to install an appropriate USB MIDI driver.

There are the two methods by which to connect the Clavinova to a personal computer:

1. Connecting the USB port on the computer to the Clavinova's USB [TO HOST] terminal (see below)
2. Using a MIDI interface and the Clavinova's MIDI terminals (page 66)

If you are using a computer that has a USB interface, we recommend that you connect the computer and the instrument by USB, rather than by MIDI.

For more information, refer to the following pages.

⚠ CAUTION

When connecting the Clavinova to a personal computer, first turn off the power of the Clavinova and quit any application software that is open on the computer before connecting any cables. After making connections, turn on the power to the Clavinova.

⚠ CAUTION

If you are not using the connection between the Clavinova and your computer, you must disconnect the cable from the USB [TO HOST] terminal. The Clavinova may not operate correctly if a cable is left connected.

Connecting the USB port on the computer to the Clavinova's USB [TO HOST] terminal

Use a USB cable to connect the USB port on your computer to the USB [TO HOST] terminal on the Clavinova.

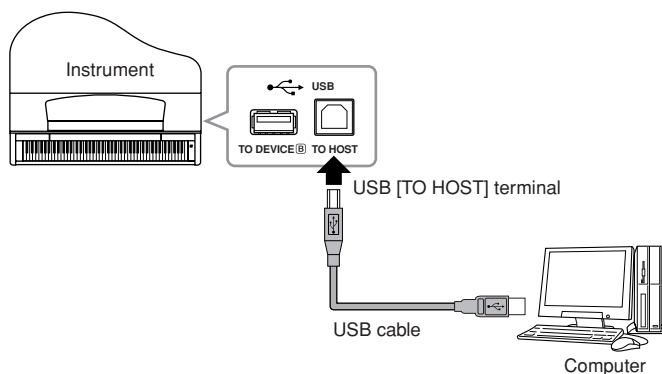

TERMINOLOGY

Driver:

A driver is software that provides a data-transfer interface between the computer's operating system and a connected hardware device. You need to install a USB MIDI driver to connect the computer and the instrument.

TIP

- The instrument will begin transmission a short time after the USB connection is made.
- When using a USB cable to connect the instrument to your computer, make the connection directly without passing through a USB hub.
- For information on setting up your sequence software, refer to the owner's manual of the relevant software.

⚠ CAUTION**Precautions when using the USB [TO HOST] terminal**

When connecting the computer to the USB [TO HOST] terminal, make sure to observe the following points. Failing to do so risks freezing the computer and corrupting or losing data. If the computer or the instrument freezes, turn the power to the instrument off and restart the computer.

- Before connecting the computer to the USB [TO HOST] terminal, exit from any power-saving mode of the computer (such as suspended, sleep, standby), and quit any open application software, also turns off the power to the instrument.
- Execute the following before turning the power to the instrument off or unplugging the USB cable to/from the instrument/computer.
 - Quit any open application software on the computer.
 - Make sure that data is not being transmitted from the instrument. (Data is transmitted only by playing notes on the keyboard or playing back a song.)
- **While a USB device is connected to the instrument, you should wait for six seconds or more between these operations: When turning the power of the instrument off then on again, or when alternately connecting/disconnecting the USB cable.**

Using a MIDI interface and the Clavinova's MIDI terminals

Use a MIDI interface device to connect a computer to the Clavinova using special MIDI cables.

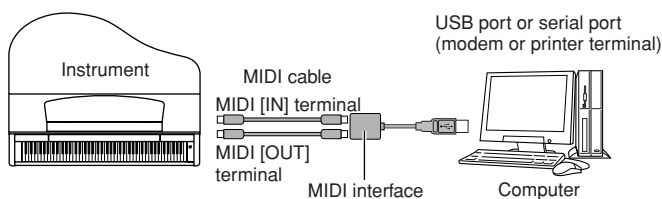

Detailed Settings

Detailed Settings

You can set various parameters to make the best use of Clavinova functions, such as fine tuning the pitch, selecting a voice for the metronome, repeating playback, etc. For the basic procedure to make these settings, refer to page 93.

Parameter List

Recording and playback [FILE/SONG SETTING]

Settings	Parameter name	Reference page
Saving recorded songs to a USB storage device	Save	48
Deleting a song from the Clavinova's Storage memory or from a USB storage device	Delete	49
Renaming files	Rename	50
Copying files	Copy	51
Moving files	Move	53
Making folders in the USB storage device	MakeDir	54
Formatting a USB storage device	Format	54
Automatically selecting a song in storage media	SongAutoOpen	55
Changing the type of characters on screen	CharacterCode	55
Playing back a song/all songs repeatedly	SongRepeat	73
Playing back the phrase specified by the phrase number	PhraseMark	73
Correcting note timing	Quantize	74
Specifying whether playback starts immediately along with the first voicing	QuickPlay	74
Auditioning the channels	ChannelListen	75
Deleting data from each channel	ChannelClear	75
Selecting a record starting method	RecStart	39
Selecting a record ending method	RecEnd	39
Recording parts 3-16 (Extra Parts)	RecExtraPartsCh	41

Metronome [METRONOME SETTING]

Settings	Parameter name	Reference page
Setting the metronome time signature	TimeSignature	76
Setting the metronome volume level	MetronomeVolume	76
Setting the metronome voice	MetronomeSound	76

Voices [VOICE SETTING]

In Dual mode, parameters with the “*” mark are set for Voice 1 and Voice 2 individually.

Settings	Parameter name	Reference page
Setting the octave*	Octave	78
Setting the volume level*	Volume	78
Setting the position of right and left channels*	Pan	78
Make fine adjustments to the pitch (only in Dual mode)	Detune	78
Selecting the reverb type	ReverbType	79
Setting the reverb depth*	ReverbSend	79
Selecting the chorus type	ChorusType	79
Setting the chorus depth*	ChorusSend	79
Setting the chorus on/off	ChorusOnOff	80
Selecting the DSP type*	DSP Type (DSP)	80
Setting the speed of the vibraphone vibrato effect*	VibeRotorSpeed	80
Turning the vibraphone vibrato effect on/off*	VibeRotorOnOff (RotorOnOff)	80
Setting the rotation speed of the rotary speaker*	RotarySpeed (Rot.Speed)	81
Adjusting the depth of the DSP effect*	DSPDepth	81
Adjusting the brightness of the sound*	Brightness	81
Adjusting the resonance effect*	HarmonicContent (Harmonic)	81
Adjusting the low-range frequency of the equalizer*	EQ LowFreq. (EQ L.Freq)	81
Adjusting the low-range gain (amount of boost/cut) of the equalizer*	EQ LowGain	82
Adjusting the high-range frequency of the equalizer*	EQ HighFreq. (EQ H.Freq)	82
Adjusting the high-range gain (amount of boost/cut) of the equalizer*	EQ HighGain	82
Setting the touch sensitivity*	TouchSense	82

iAFC [iAFC SETTING]

Settings	Parameter name	Reference page
Turning iAFC on/off	iAFC	83
Adjusting the Dynamic Damper Effect depth	DynDmpFX Depth	83
Adjusting the Spatial Effect depth	SpatialFX Depth	84
Calibration (automatic adjustment)	Calibration	84
Restoring the default calibration setting	iAFC Default	84

Other settings [FUNCTION]

Settings	Parameter name	Reference page
Changing the key	Transpose	85
Selecting a touch response	TouchResponse	85
Fine tuning the pitch	Tune	86
Selecting a tuning curve for a piano voice	PianoTuningCurve	86
Selecting a scale	Scale	86
Specifying the Split Point	SplitPoint	87
Setting the right pedal function	RPedalFunc	87
Setting the center pedal function	CPedalFunc	87
Setting the left pedal function	LPedalFunc	87
Setting the auxiliary pedal function	AuxPedalFunc	88
Turning the right pedal function on/off	RPedalOnOff	88
Turning the center pedal function on/off	CPedalOnOff	88
Turning the left pedal function on/off	LPedalOnOff	88
Turning the auxiliary pedal function on/off	AuxPedalOnOff	89
Assigning the SONG [PLAY/PAUSE] function to the pedal	PedalPlay/Pause	89
Selecting a type of auxiliary pedal	AuxPedalType	89
Setting the point at which the damper pedal starts to affect the sound	HalfPedalPoint	89
Adjusting the depth of the Soft pedal	SoftPedalDepth	89
Setting the depth of string resonance	StringResonanceDepth	90
Setting the depth of sustain sampling for the damper pedal	SustainSamplingDepth	90
Specifying the volume of the key-off sound	KeyOffSamplingDepth	90
Setting the range of pitch bend	PitchBendRange	90
Switching the speaker on/off	Speaker	90
Selecting the AUX OUT level (Fixed/Variable)	AuxOutLevel	91
Setting the MIDI transmit channel	MidiOutChannel	91
Setting the MIDI receive channel	MidiInChannel	91
Turning local control on/off	LocalControl	92
Selecting performance from the keyboard or song data for MIDI transmission	MidiOutSelect	92
Selecting a type of data received via MIDI	ReceiveParameter	92
Selecting a type of data transmitted via MIDI	TransmitParameter	92
Transmitting the initial settings on the panel	InitialSetup	93
Selecting items saved at shutdown	MemoryBackup	93
Restoring the normal (default) settings	FactorySet	93
Backing up the Clavinova's internal data	FullBackup	94

Making detailed settings

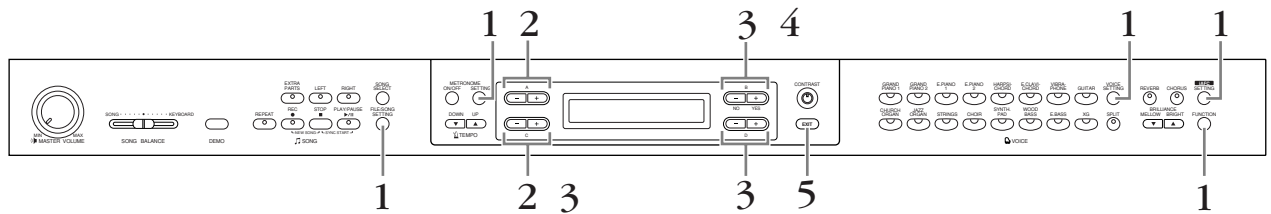

Procedure

- 1. Access a setting menu.**
 Press the desired setting button ([FILE/SONG SETTING], METRONOME [SETTING], [VOICE SETTING], [iAFC SETTING], or [FUNCTION]) to access the corresponding setting menu.
 Press the [EXIT] button any time to close the setting menu.
- 2. Select the desired parameter or part.**
 Press the setting button, A [-][+], and/or C [-][+] buttons repeatedly as required.
- 3. Set the parameter or part.**
 Some parameters or parts lead you to more options. Use the B [- (NO)][+ (YES)], C [-][+], and D [-][+] buttons to select or set the option.
 To restore the normal parameter value, press the [-] and [+] buttons simultaneously.

4. Write, execute, or save the data.

There are two ways to respond to the messages.

If "Execute?→" or "Start?→" appears:

Press the B [+ (YES)] button to display confirmation ("Sure?→"). To proceed, press the B [+ (YES)] button again. The Clavinova displays "Executing" and writes the data. When the operation is complete, it displays "Completed" for three seconds, then returns to the previous screen.

To cancel the operation, press the B [- (NO)] button instead of the B [+ (YES)] button.

When "Overwrite?→" appears after the "Completed" message, press the B [+ (YES)] button.

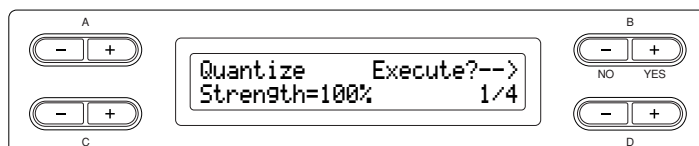

If "Set?→" appears:

Press the B [+ (YES)] button to execute the setting. The Clavinova displays "Executing" and saves the data. When the operation is complete, it displays "Completed" for three seconds, then returns to the previous screen.

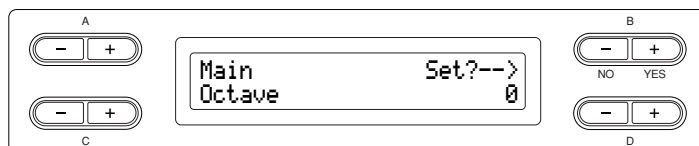

5. Close the setting menu.

Press the [EXIT] button.

Detailed settings for recording and playback [FILE/SONG SETTING]

For information on the settings “Save” – “CharacterCode,” see “Handling files such as deleting song files ... [FILE/SONG SETTING]” on page 45.

You can make detailed settings for the selected song. First, select the desired song from preset songs (“PRE-SET”), memory songs (“MEMORY”), or External songs (“USB1”) (see page 56).

Procedure

Select the desired song and press the [FILE/SONG SETTING] button to access the “File/Song Setting” menu.

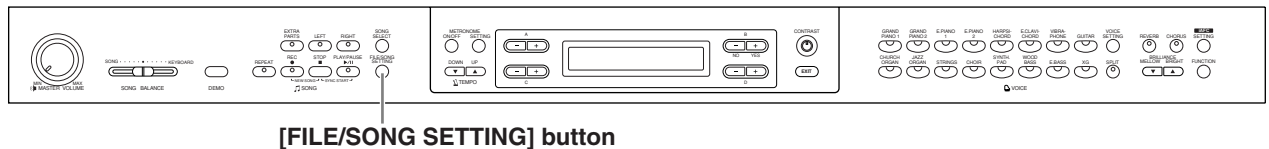

Playing back a song/all songs repeatedly [SongRepeat]

You can repeatedly play back all songs or a single song selected from the 50 preset songs or from the USB storage devices.

- When you start playback, the Clavinova plays the song you selected using the front panel, then starts repeat playback of the specified songs until you press the [STOP] button.

See the procedure on page 71.

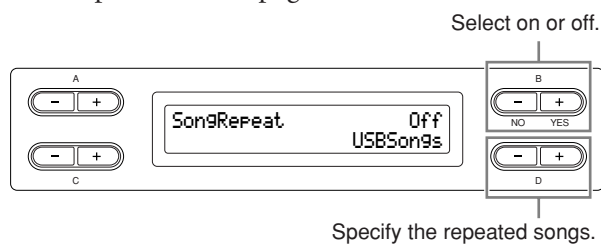

Setting range:

[USBSongs]	All songs in the media inserted in the USB storage device
[MemorySongs]	All songs in the Clavinova’s memory
[USB+Memory]	All songs from “USBSongs” and “MemorySongs”
[PresetSongs]	All 50 preset songs
[ALL]	All songs from “USBSongs,” “MemorySongs,” and “PresetSongs”
[OneSong]	One song selected from the front panel

TIP

When several USB storage devices are connected, the device which contains the previously selected song is the destination device.

Playing back the phrase specified by the phrase number [PhraseMark]

If you select a song from an ensemble collection disk, such as the “Disk Orchestra Collection” or one of the “XG for Piano” disks, you can specify phrase numbers in the score to play back from the score from the mark point, or to play back the phrase repeatedly.

- If you start playing back a song with “Repeat On” selected, the count down starts, followed by the repeated playback of the specified phrase until you press the [STOP] button.
- If you select “Repeat Off,” normal playback starts without repeat.

See the procedure on page 71.

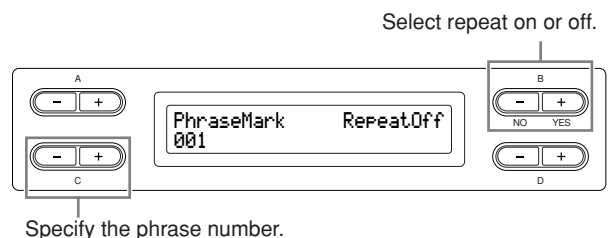

Setting range of the phrase number:

- (not specified)
 - 0 - the last phrase number of the song
- If you select any song other than those from the “Disk Orchestra Collection” or one of the “XG for Piano” disks, you can select only “Off.”

Correcting note timing [Quantize]

You can correct the timing of notes. For example, you can adjust recorded notes to precise eighth or sixteenth notes.

- Changes are made by song.
- See the procedure on page 71.

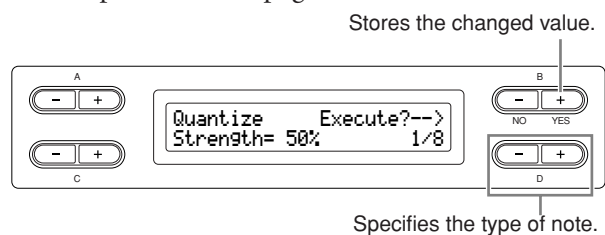

Notes for which you can adjust the timing:

- 1/4..... quarter note
- 1/6..... quarter note triplet
- 1/8..... eighth note
- 1/12..... eighth note triplet
- 1/16..... sixteenth note
- 1/24..... sixteenth note triplet
- 1/32..... thirty-second note
- 1/8+1/12..... eighth note + eighth note triplet*
- 1/16+1/12..... sixteenth note + eighth note triplet*
- 1/16+1/24..... sixteenth note + sixteenth triplet*

The three Quantize settings marked with asterisks (*) are exceptionally convenient, since they allow you to quantize two different note values at the same time. For example, when the straight eighth notes and eighth notes triplet are contained in the same part, if you quantize by the straight eighth notes, all notes in the part are quantized to straight eighth notes—completely eliminating any triplet feel. However, if you use the eighth note + eighth note triplet setting, both the straight and triplet notes will be quantized correctly.

From this display, you can determine how strongly the notes will be quantized. A setting of 100% produces exact timing. If a value less than 100% is selected, notes will be moved toward the specified quantization beats according to the specified percentage. Applying less than 100% quantization lets you preserve some of the “human” feel in the recording.

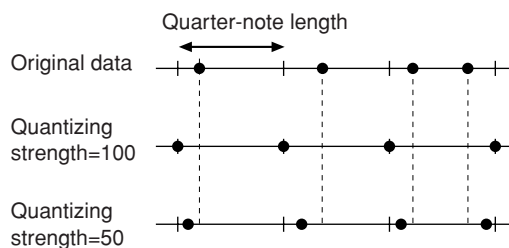

Setting range:

0% – 100%

Specifying whether playback starts immediately along with the first voicing [QuickPlay]

This parameter enables you to specify whether a song that starts from the middle of a bar, or a song with a silence prior to the first note, should be played from the first note or from the top of the bar (rest or blank).

See the procedure on page 71.

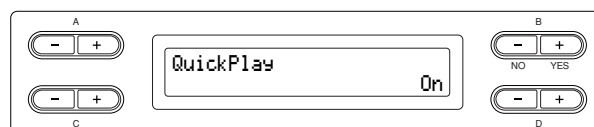

Setting range:

- [On] Playing from the first note
- [Off] Playing from the top of the bar (including a rest or blank)

Auditioning the channels [ChannelListen]

You can select a single channel to listen to its contents. Playback starts from the first note. See the procedure on page 71.

Playback continues as long as you press and hold down this button.

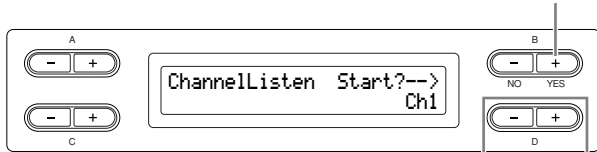

Select the desired channel for playback.

Setting range:

Ch1 - Ch16

TIP

The song data consists of 16 channels. A channel is assigned to a part, so in this instrument, channel means the same as part.

TIP

Even channels that contain no data are displayed.

Deleting data from each channel [ChannelClear]

You can delete data from each of 16 channels. See the procedure on page 71.

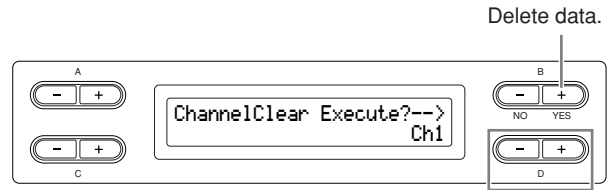

Select the desired channel for deletion.

Setting range:

Ch1 - Ch16, ALL (all channels)

TIP

The song data consists of 16 channels. A channel is assigned to a part, so in this instrument, channel means the same as part.

TIP

Even channels that contain no data are displayed.

TIP

When you clear all channels using the "ALL" parameter, you can overwrite the song. In this case, the file which contains song settings with no channel data is saved.

For information on the settings "RecStart" and "RecEnd," see "Re-recording a song partially" on page 39.

For information on the setting "RecExtraPartsCh," see "Recording a performance of several different parts" on page 41.

Detailed settings for the metronome

METRONOME [SETTING]

You can set the time signature, volume level, and voice of the Clavinova metronome.

Procedure

Press the METRONOME [SETTING] button to access the Metronome Setting menu.

METRONOME [SETTING] button

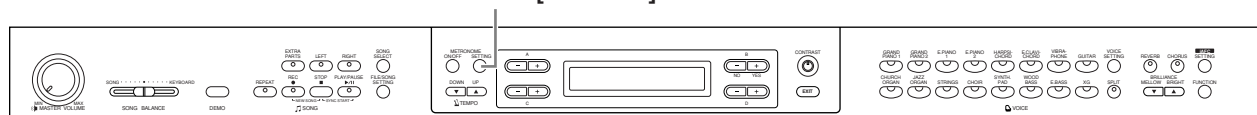

Setting the metronome time signature [TimeSignature]

See the procedure on page 71.

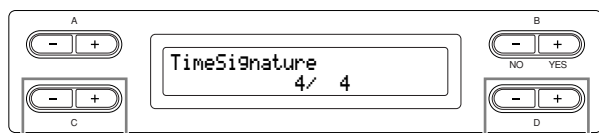

For example, to specify “3/4,” use the C [-][+] buttons to select “3” and the D [-][+] buttons to select “4.”

Setting range for the numerator:

1 - 16

Setting options for the denominator:

2, 4, and 8

Setting the metronome volume level [MetronomeVolume]

See the procedure on page 71.

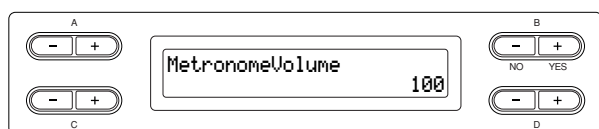

Setting range:

0 - 127

Selecting the metronome voice [MetronomeSound]

See the procedure on page 71.

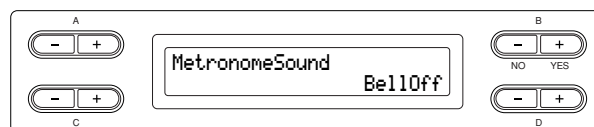

Setting range:

- | | |
|-----------------|------------------------------------|
| [BellOff] | Click (standard metronome sound) |
| [EnglishVoice] | Click and “1, 2, 3, 4” in English |
| [GermanVoice] | Click and “1, 2, 3, 4” in German |
| [JapaneseVoice] | Click and “1, 2, 3, 4” in Japanese |
| [FrenchVoice] | Click and “1, 2, 3, 4” in French |
| [SpanishVoice] | Click and “1, 2, 3, 4” in Spanish |
| [BellOn] | Click and bell |

TIP

To mute the beat count, select “BellOff.”

Detailed settings for the voices

[VOICE SETTING]

This menu enables you to make various detailed settings for the voices in Dual or Split mode and the effects. You can make these settings for each voice (or each combination of voices) individually. You can listen to the notes you play on the keyboard while changing the settings.

Procedure

1. Select a voice and press the [VOICE SETTING] button to access the “Voice Setting” menu.

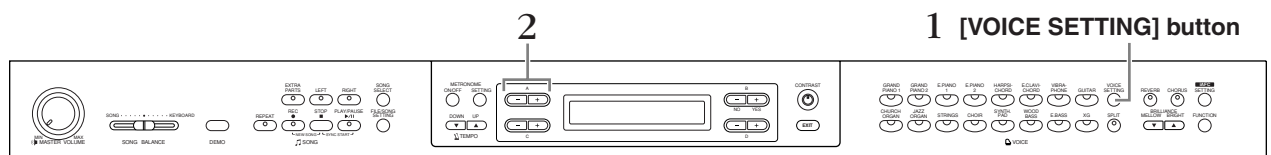

2. Press the A [-][+] buttons to select the part for which you wish to change the voice.

The range of the displayed part varies depending on the selected voice.

- [Main] MAIN voices (displayed with a single voice or in Split mode)
- [Main × Layer] MAIN Voice 1 and Voice 2 (displayed when the MAIN side is in Dual mode)
- [Left] LEFT voice (displayed in Split mode)
- [Left × Layer] LEFT Voice 1 and Voice 2 (displayed when the LEFT side is in Dual mode)

Detailed settings for the voices [VOICE SETTING]

TIP

In Dual mode, parameters with the "*" mark are set for Voice 1 and Voice 2 individually.

TIP

Parameter names enclosed in parentheses () are displayed in Dual mode.

Setting the octave [Octave]*

The pitch of a note can be shifted upward or downward in steps of an octave.

See the procedure on page 71.

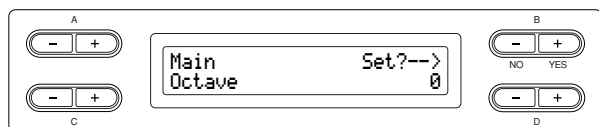

In Dual mode:

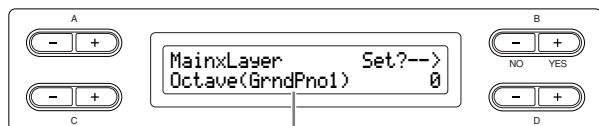

Voice for editing (Voice 1 or Voice 2)

Setting range:

-2 (two octaves lower) - 0 (no pitch shift) - +2 (two octaves higher)

Setting the volume level [Volume]*

You can set the volume level for each voice part. See the procedure on page 71.

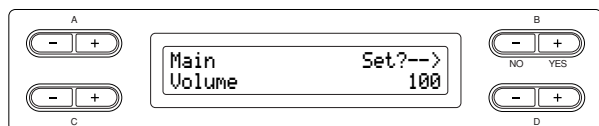

In Dual mode:

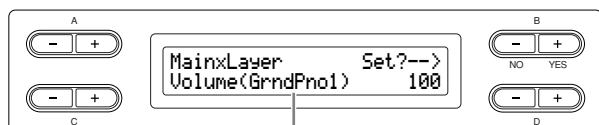

Voice for editing (Voice 1 or Voice 2)

Setting range:

0 - 127

Setting the position of right and left channels [Pan]*

You can specify the position in the stereo image from which you hear the sound.

See the procedure on page 71.

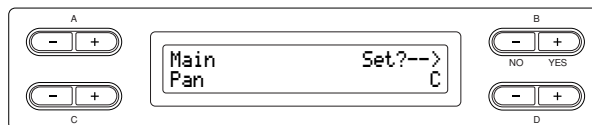

In Dual mode:

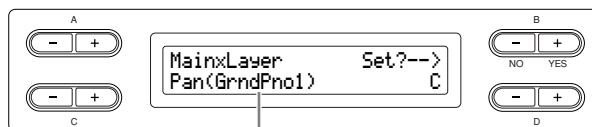

Voice for editing (Voice 1 or Voice 2)

Setting range:

L64 (hard left) - C (center) - R63 (hard right)

Make fine adjustments to the pitch (only in Dual mode) [Detune]

The pitch of the two sounds selected in Dual mode can be "skewed" slightly away from each other.

See the procedure on page 71.

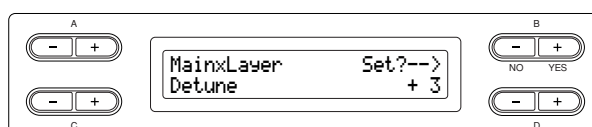

Setting range:

-20 - +20 (Positive (+) settings will raise the pitch of the first sound and lower the pitch of the second sound. Negative (-) settings will do the opposite.)

Setting the reverb type [ReverbType]

TIP

You cannot set this parameter for the voice parts "Left" and "LeftXLayer."

See the procedure on page 71.

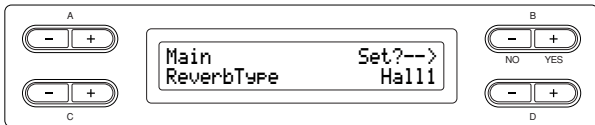

Setting range:

- Room Simulates reverberation in a room.
- Hall1 Simulates reverberation in a concert hall.
- Hall2 Reverberation is slightly longer than that of "Hall1."
- Stage Reverberation suitable for a solo instrument sound.
- Plate Reverberation from the vibration of a metal plate.

Setting the reverb depth [ReverbSend]*

TIP

The reverb effect is not applied if the ReverbSend parameter is set to "0."

See the procedure on page 71.

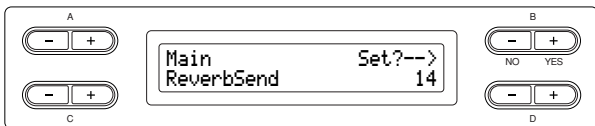

In Dual mode:

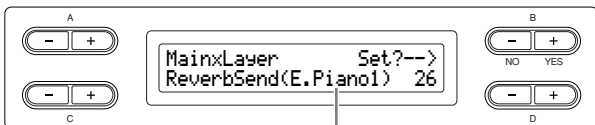

Voice for editing (Voice 1 or Voice 2)

Setting range:

0 - 127

Selecting the chorus type [Chorus Type]

TIP

You cannot set this parameter for the voice parts "Left" and "Left X Layer."

See the procedure on page 71.

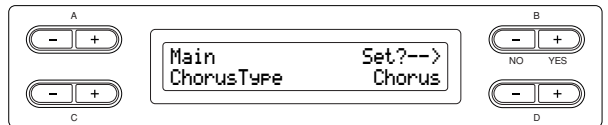

Setting range:

- Chorus Adds a rich, spacious sound.
- Celeste Adds swell and a spacious sound.
- Flanger Adds swell effects of an ascending or descending jet plane.

Setting the chorus depth [ChorusSend]*

See the procedure on page 71.

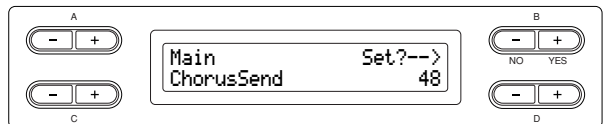

In Dual mode:

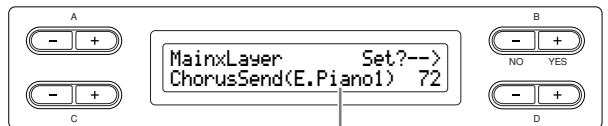

Voice for editing (Voice 1 or Voice 2)

Setting range:

0 - 127

Detailed settings for the voices [VOICE SETTING]

Setting the chorus on/off [ChorusOnOff]

You can set the [CHORUS] button on or off for each voice. When you select a voice, the chorus on/off setting for the voice automatically changes according to this parameter.

TIP

Even if this parameter is turned on, the chorus effect is disabled if the ChorusSend parameter is set to 0.

See the procedure on page 71.

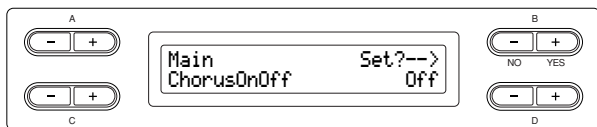

Setting range:

On/Off

Selecting the DSP type* [DSP Type (DSP)]

You can select other effects (than reverb and chorus).

See the procedure on page 71.

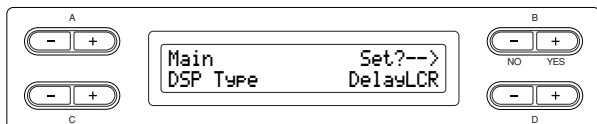

Setting range:

DelayLCR	Delay applied at left, center, and right positions.
DelayLR	Delay applied at left and right positions.
Echo	Echo-like delay
CrossDelay	Left and right delays are crossed.
Symphonic	Adds a rich and deep acoustic effect.
Rotary	Adds the vibrato effect of a rotary speaker.
Tremolo	The volume level changes in rapid cycles.
VibeRotor	The vibrato effect of a vibraphone.
AutoPan	The sound pans left to right and back and forth.
Phaser	The phase changes periodically, swelling the sound.
AutoWah	The center frequency of the wah filter changes periodically.

SoundBoard	Simulates the reverberation of a piano soundboard.
Off	No effect.

Setting the speed of the vibraphone vibrato effect* [VibeRotorSpeed]

TERMINOLOGY

Rotor= The rotating portion of an electrical device etc.

This will be displayed only if VibeRotor is selected for the DSP Type parameter explained above.

This sets the speed of the vibrato effect that is applied when you have selected Vibraphone and are using the VibeRotor pedal.

See the procedure on page 71.

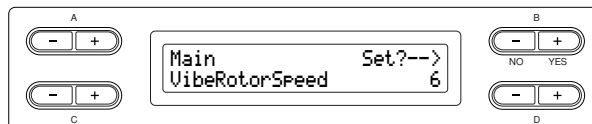

Setting range:

1 - 10

Turning the vibraphone vibrato effect on/off* [VibeRotorOnOff (RotorOnOff)]

This will be displayed only if VibeRotor is selected for the DSP Type parameter explained above.

It turns on/off the vibrato effect that is applied when you use the VibeRotor pedal.

See the procedure on page 71.

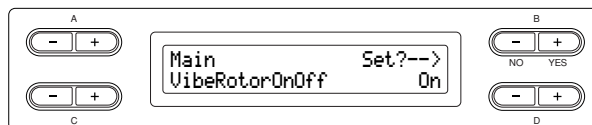

Setting range:

On/Off

Setting the rotation speed of the rotary speaker* [RotarySpeed (Rot.Speed)]

This will be displayed only if Rotary is selected for the DSP Type parameter explained above. It sets the rotation speed of the rotary speaker effect. See the procedure on page 71.

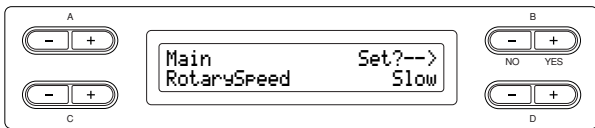

Setting range:
Slow/Fast

Adjusting the depth of the DSP effect* [DSPDepth]

This sets the depth of the DSP effect (page 80). Some DSP Type settings do not allow you to set the DSPDepth. See the procedure on page 71.

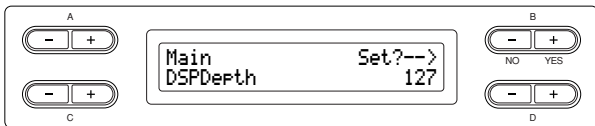

Setting range:
1 (output only the original sound with almost no effect applied) - 127 (output only the sound processed by the effect)

Adjusting the brightness of the sound* [Brightness]

See the procedure on page 71.

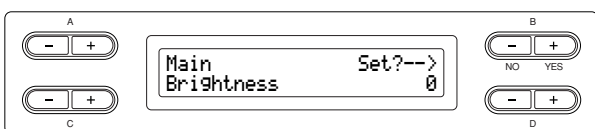

Setting range:
-64 - +63

Adjusting the resonance effect* [HarmonicContent (Harmonic)]

See the procedure on page 71.

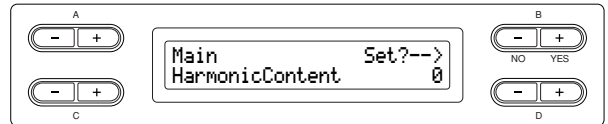

Setting range:
-64 - +63

TIP

Resonance can produce a distinctive "peaky" tone, making the sound brighter and harder.

Adjusting the low-range frequency of the equalizer* [EQ LowFreq. (EQ L.Freq)]

TERMINOLOGY

Equalizer:

An audio equalizer divides the frequency spectrum into multiple regions and enables the user to adjust the relative amplitude of each region.

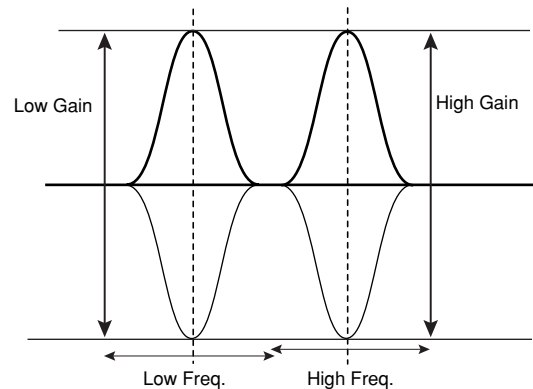

See the procedure on page 71.

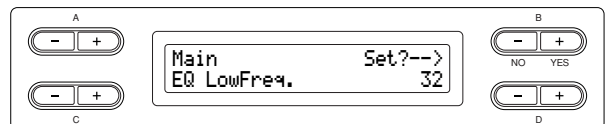

Setting range:
32 Hz - 2.0 kHz

Adjusting the low-range gain (amount of boost/cut) of the equalizer* [EQ LowGain]

See the procedure on page 71.

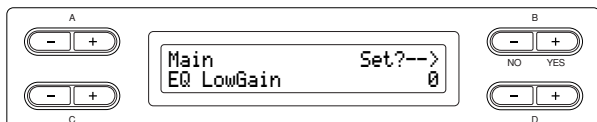

Setting range:

-12 - +12 dB

Adjusting the high-range frequency of the equalizer* [EQ HighFreq. (EQ H.Freq.)]

See the procedure on page 71.

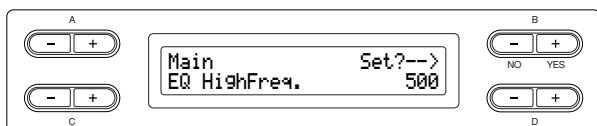

Setting range:

500 Hz - 16.0 kHz

Adjusting the high-range gain (amount of boost/cut) of the equalizer* [EQ HighGain]

See the procedure on page 71.

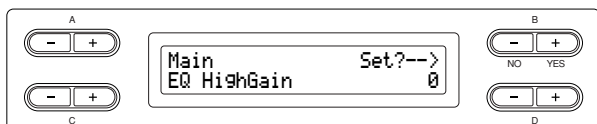

Setting range:

-12 - +12 dB

Setting the touch sensitivity [TouchSense]*

This parameter enables determines the manner and degree to which the volume level changes in response to your touch on the keyboard (how hard you play). Since the volume level of the harpsichords and pipe organs do not change regardless of how you play the keyboard, the normal setting for these voices is 127. (See the setting range below.) See the procedure on page 71.

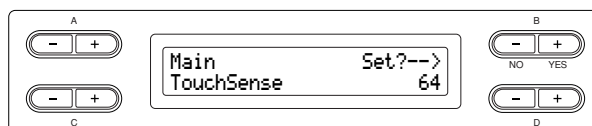

In Dual mode:



Voice for editing (Voice 1 or Voice 2)

Setting range:

0 (softest) - 64 (largest changes in the level) - 127 (loudest and fixed)

Detailed settings for iAFC

[iAFC SETTING]

When iAFC is engaged, the Clavinova will sound deeper and more resonant, similar to an acoustic musical instruments. This lets you experience the ambience and reverberation that are characteristic of performing on stage or simulates the sustain sound that occur when you press the damper pedal of a grand piano. This section describes how to make various settings for the iAFC function. You can also perform an automatic adjustment in order to obtain the optimal iAFC effect.

Procedure

Press [iAFC SETTING] button to enter iAFC Setting mode.



Perform the automatic adjustment after you turn on the power of the Clavinova for the first time, and after each time you move the Clavinova (page 84).
When the [iAFC SETTING] button is pressed before performing the automatic adjustment, the “Calibration” screen will be displayed.

TIP

iAFC cannot be used in the following cases.

- When the lid is closed or open with the shorter stay.
- When the Speaker setting is Normal, and headphones are connected.
- When the Speaker setting is off.

TIP

When using iAFC, do not block the speaker located on the rear panel of the Clavinova. The optimal iAFC effect cannot be obtained if this speaker is blocked.

TIP

iAFC uses Yamaha’s EMR (Electronic Microphone Rotator) technology to ensure stability against acoustic feedback.

Turning iAFC on/off [iAFC]

See the procedure on page 71.

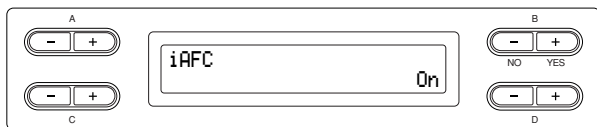

Setting range:

On/Off

Adjusting the Dynamic Damper Effect depth [DynDmpFX Depth]

Dynamic Damper Effect is one type of the iAFC effect. Dynamic Damper Effect simulates the sustain sound that occurs when you press the damper pedal of a grand piano. The internal microphones are not used, but the sound produced within the Clavinova is processed to create a spacious sensation, as you press the damper pedal and play the keyboard.

See the procedure on page 71.

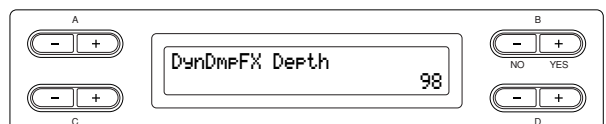

Setting range:

0 - 127

Adjusting the Spatial Effect depth [SpatialFX Depth]

Spatial Effect is one type of the iAFC effect. Spatial Effect creates a sense of reverberation and spaciousness by picking up the output sound using internal microphones and output the sound from the speaker on the rear of the instrument. The spread and spaciousness of the sound is different depending on the depth. For lower depth settings, this creates the resonance and enhances the acoustic realism of the sound that is characteristic of acoustic instruments by creating a virtual sound-board. For deeper depth settings, the sound of the instrument itself and the sound of singing and other instruments played nearby is picked up by internal microphones, and processed to simulate the spatial characteristics of performing together on stage.

See the procedure on page 71.

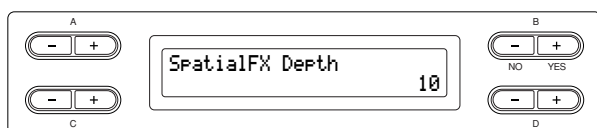

Setting range:

0 - 127

Calibration (automatic adjustment) [Calibration]

This automatically adjusts the sensitivity and response of iAFC so that the optimal iAFC effect will be obtained.

When automatic adjust begins, a test sound (noise) will sound for about five seconds.

While automatic adjustment is being performed, do not make audible noises in the vicinity of the Clavinova.

See the procedure on page 71.

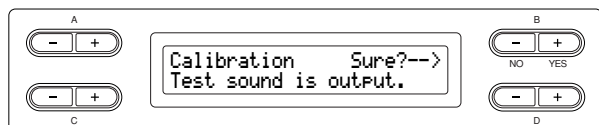

TIP

The keyboard will not produce sound while automatic adjustment is being performed. Nor is it possible to adjust the volume of the Clavinova.

Restoring the default calibration setting [iAFC Default]

This sets the calibration function to the default setting.

See the procedure on page 71.

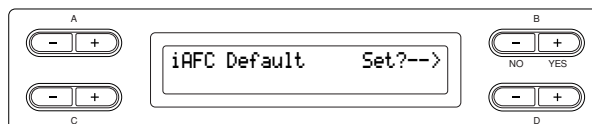

Other settings [FUNCTION]

You can make detailed settings for touch, tuning, scale, etc.

Procedure

Press the [FUNCTION] button to enter Function mode.

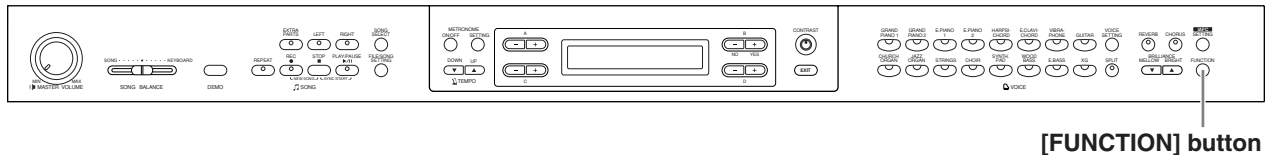

[FUNCTION] button

Changing the key [Transpose]

TIP

TRANSPOSE= To change the key
(Changing the key: To raise or lower the overall pitch of the entire song.)
The Clavinova's Transpose function makes it possible to shift the pitch of the entire keyboard up or down in semitone intervals to facilitate playing in difficult key signatures, and to let you easily match the pitch of the keyboard to the range of a singer or other instruments. For example, if you set the transposition amount to "5," playing key C produces pitch F. In this way, you can play the song as if it were in C major, and the Clavinova will transpose it to the key of F.

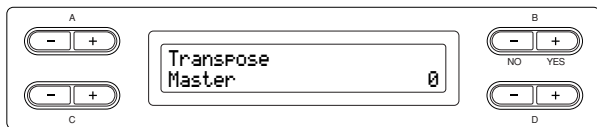

Setting for:

- Master The sound of the entire instrument (the manually-played sound and the song playback)
- Keyboard The manually-played sound
- Song The song playback

Setting range:

-12 (-1 octave) - 0 (normal pitch) - +12 (+1 octave)

Selecting a touch response [TouchResponse]

You can specify a touch response (how the sound responds to the way you play the keys). See the procedure on page 71.

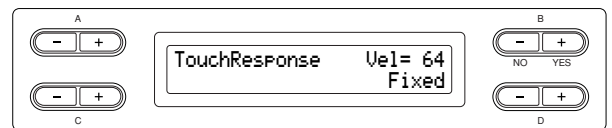

Setting range:

- Light** With a soft touch, the Clavinova produces a loud sound. The volume level of tones tends to be consistent.
- Medium** Standard touch response.
- Heavy** You must hit the key very hard to generate a loud volume. This allows for versatile expression, from pianissimo to fortissimo tones.
- Fixed** No touch response. The volume level will be the same regardless of how hard you play the keys. Use the B [-][+] buttons to set the volume level.

Setting range of the "Fixed" volume level:

1 - 127

Fine tuning the pitch [Tune]

You can fine tune the pitch of the entire instrument. This function is useful when you play the Clavinova along with other instruments or CD music.

See the procedure on page 71.

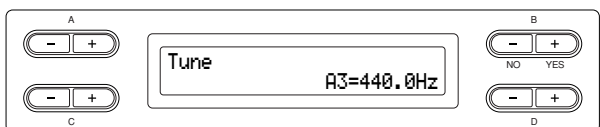

Setting range:

A3 = 414.8 Hz - 466.8 Hz (0.2 Hz steps)

Selecting a tuning curve for a piano voice [PianoTuningCurve]

You can select a tuning curve from “GrandPiano1” and “GrandPiano2.” Select “Flat” if you feel the tuning curve of the piano voice does not quite match that of other instruments voices.

See the procedure on page 71.

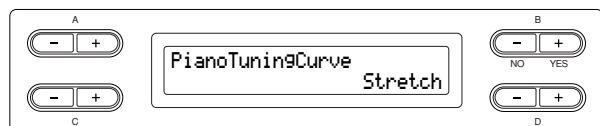

Setting range:

- Stretch Tuning curve particularly for pianos
- Flat Tuning curve in which the frequency is octave doubled over the entire keyboard range

Selecting a scale [Scale]

You can select various scales.

Equal Temperament is the most common contemporary piano tuning scale. However, history has known numerous other scales, many of which serve as the basis for certain genres of music. You can experience the tunings of these genres.

See the procedure on page 71.

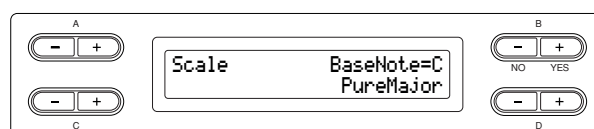

Setting range:

- Equal One octave is divided into twelve equal intervals. Currently most popular piano tuning scale.
- PureMajor/PureMinor Based on natural overtones, three major chords using these scales produce a beautiful, pure sound.
- Pythagorean This scale, designed by Pythagoras, a Greek philosopher, is based on the interval of a perfect 5th. The 3rd produces swells, but the 4th and 5th are beautiful and suitable for some leads.
- MeanTone This scale is an improvement of the Pythagorean in that the swell of the 3rd has been eliminated. It spread during the late 16th century through the late 18th century. Handel used this scale.
- Werckmeister/Kirnberger These scales combine Mean Tone and Pythagorean in different ways. With these scales, modulation changes the impression and feel of the songs. They were often used in the era of Bach and Beethoven. They are also often used now to reproduce the music of that era on harpsichords.

Normal setting:

Equal
If you select a scale other than Equal, you need to specify the root note using the B [-][+] buttons.

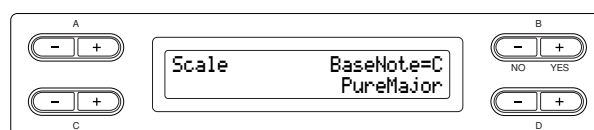

Setting range:

C, C[♯], D, E^b, E, F, F[♯], G, A^b, A, B^b, B

Specifying the Split Point [Split Point]

You can specify the split point (the boundary between the right-hand and left-hand keyboard areas). See the procedure on page 71.

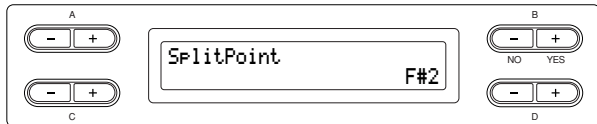

Setting range:

A-1 - C7

TIP

You can also use [SPLIT] to set the split point. (page 34)

Setting the right pedal function [RPedalFunc]

See the procedure on page 71.

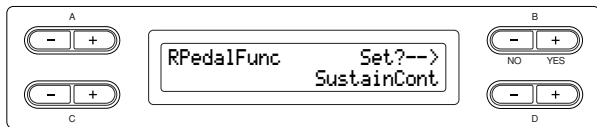

Setting range:

Sustain	ON/OFF switch type damper
SustainCont	Damper that sustains the sound proportionately to how deeply you press the pedal
Sostenuto	Sostenuto (page 28)
Soft	Soft (page 28)
Expression	A function that lets you create changes in dynamics (volume) as you play
PitchBend Up	A function that smoothly raises the pitch
PitchBend Down	A function that smoothly lowers the pitch
RotarySpeed	Change the rotational speed of the JazzOrgan rotary speaker (switch between fast/slow each time you press the pedal)
VibeRotor	Switch the vibraphone vibrato on/off (switch on/off each time you press the pedal)

Normal setting:

SustainCont

Setting the center pedal function [CPedalFunc]

See the procedure on page 71.

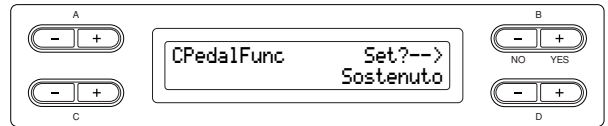

Setting range:

Same as “Setting the right pedal function” above, except for the following parameters.

- SustainCont
- Expression
- PitchBend Up
- PitchBend Down

Normal Setting:

Sostenuto

Setting the left pedal function [LPedalFunc]

See the procedure on page 71.

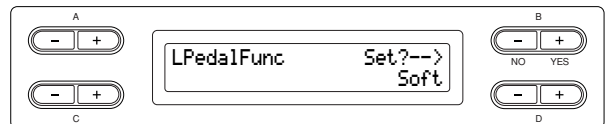

Setting range:

Same as “Setting the right pedal function” above, except for the following parameters.

- SustainCont
- Expression
- PitchBend Up
- PitchBend Down

Normal Setting:

Soft (for all voices other than JazzOrgan, MellowOrgan and VibraPhone), Rotary Speed (JazzOrgan and MellowOrgan), Vibraphone (VibeRotor)

Setting the auxiliary pedal function [AuxPedalFunc]

You can assign a function to the pedal connected to the Clavinova's AUX PEDAL jack. See the procedure on page 71.



Setting range:
Same as "Right pedal function assignment" (page 87).

Normal setting:
Expression

TIP

- YAMAHA FC7 foot controller
This foot controller is suitable for controlling Expression, SustainCont, or PitchBend Up/Down.
- YAMAHA FC4 foot switch
YAMAHA FC5 foot switch
These foot switches are suitable for controlling Sustain, Sostenuto, Soft, RotarySpeed, or VibeRotor.

Turning the right pedal function on/off [RPedalOnOff]

This turns the right pedal function on or off for the relevant voice part. In other words, you can select the desired voice part (Main, MainLayer, Left, LeftLayer) and determine whether the right pedal function (set on page 87) will affect that part or not. See the procedure on page 71.

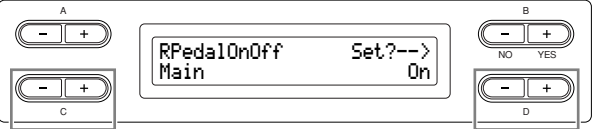

Select the voice part for which the right pedal on/off setting is to be changed. Select on or off.

Setting for:
Main, MLayer (MainLayer), Left, LLayer (LeftLayer)

Setting range:
On/Off

Normal Setting:
Different for each voice.

Turning the center pedal function on/off [CPedalOnOff]

This turns the center pedal function on or off for the relevant voice part. In other words, you can select the desired voice part (Main, MainLayer, Left, LeftLayer) and determine whether the center pedal function (set on page 87) will affect that part or not. See the procedure on page 71.

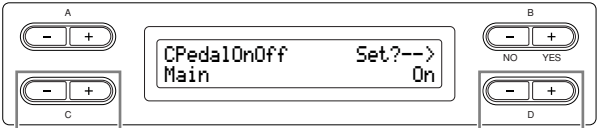

Select the voice part for which the center pedal on/off setting is to be changed. Select on or off.

Setting for:
Main, MLayer (MainLayer), Left, LLayer (LeftLayer)

Setting range:
On/Off

Normal Setting:
Different for each voice.

Turning the left pedal function on/off [LPedalOnOff]

This turns the left pedal function on or off for the relevant voice part. In other words, you can select the desired voice part (Main, MainLayer, Left, LeftLayer) and determine whether the left pedal function (set on page 87) will affect that part or not. See the procedure on page 71.

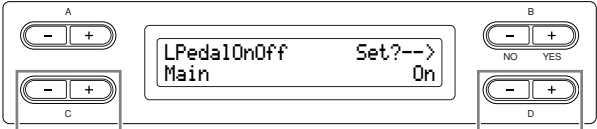

Select the voice part for which the left pedal on/off setting is to be changed. Select on or off.

Setting for:
Main, MLayer (MainLayer), Left, LLayer (LeftLayer)

Setting range:
On/Off

Normal Setting:
Different for each voice.

Turning the auxiliary pedal function on/off [AuxPedalOnOff]

This turns the auxiliary pedal function on or off for the relevant voice part. In other words, you can select the desired voice part (Main, MainLayer, Left, LeftLayer) and determine whether the auxiliary pedal function (set on page 88) will affect that part or not.
See the procedure on page 71.

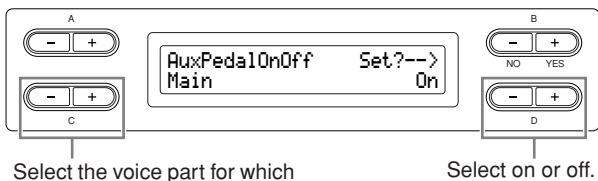

Select the voice part for which the AUX pedal on/off setting is to be changed.

Select on or off.

Setting for:

Main, MLayer (MainLayer), Left, LLayer (LeftLayer)

Setting range:

On/Off

Normal Setting:

Different for each voice.

Assigning the SONG [PLAY/PAUSE] function to the pedal [PedalPlay/Pause]

TIP

If you assign the SONG PLAY/PAUSE function to a pedal and turn the function On, the pedal function assigned to the pedal in the Function menu (pages 87 and 88) is disabled.

See the procedure on page 71.

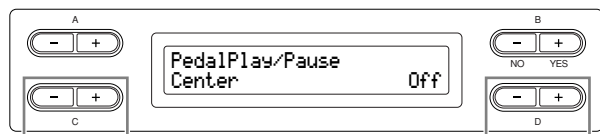

Select a pedal to assign the function

Select on or off.

Setting for:

Left, Center, AUX

Setting range:

On/Off

Normal setting:

Off for all pedals

Selecting a type of auxiliary pedal [AuxPedalType]

A pedal connected to the [AUX PEDAL] jack may switch on and off differently. For example, some pedals turn on the effects and others turn them off when you press them.

Use this parameter to reverse this mechanism. See the procedure on page 71.

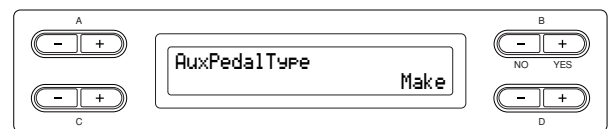

Setting range:

Make, Break

Setting the point at which the damper pedal starts to affect the sound [HalfPedalPoint]

Here you can specify the point to which you must depress the pedal (right and AUX) before the assigned effect begins to be applied. This setting applies only to the “SustainCont” effect (page 87) that is assigned to the right or AUX pedal.

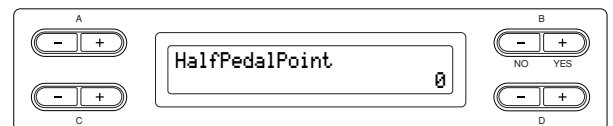

Setting range:

-2 (effective with the shallowest press) - 0 - +2 (effective with the deepest press)

Adjusting the depth of the Soft pedal [SoftPedalDepth]

See the procedure on page 71.

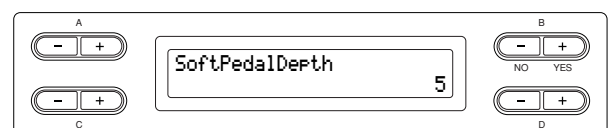

Setting range:

1 - 10

Setting the depth of string resonance [StringResonanceDepth]

This parameter is effective on the voices, such as “Grand Piano 1.”
See the procedure on page 71.

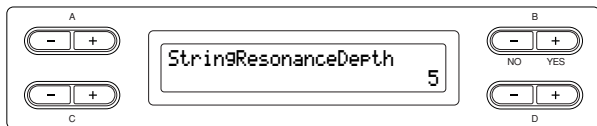

Setting range:
Off, 1 - 10

Setting the depth of sustain sampling for the damper pedal [SustainSamplingDepth]

This parameter is effective only on the voice group “GRANDPIANO1.”
See the procedure on page 71.

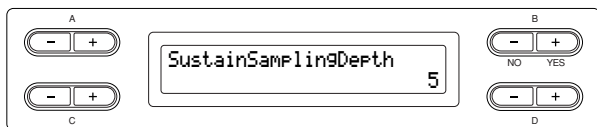

Setting range:
Off, 1 - 10

Specifying the volume of the key-off sound [KeyOffSamplingDepth]

You can adjust the volume of the key-off sound (the subtle sound that occurs when you release a key)
This is effective on the voice groups “Grand Piano1,” “Harpsichord,” and “E.Clavichord” and on the voice “E.Piano2.”
See the procedure on page 71.

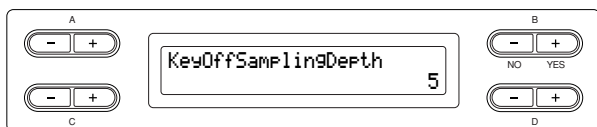

Setting range:
Off, 1 - 10

Setting the range of pitch bend [PitchBendRange]

This specifies the amount of change that can be produced by the pitch bend function which smoothly varies the pitch.

- This setting applies only to the manually-played sound.
- This setting can be made in semitone steps.
- You can set the pedal function (page 87) to specify whether the pitch will be raised or lowered.
See the procedure on page 71.



Setting range:

0 - +12 (Pressing the pedal will raise/lower the pitch by 12 semitones [1 octave])

Normal setting:

-2

Switching the speaker on/off [Speaker]

This setting lets you switch the speaker on/off.
See the procedure on page 71.

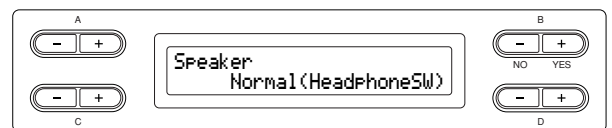

Normal (HeadphoneSW)

The speaker will sound only if headphones are not connected.

On The speaker will always sound.

Off The speaker will not sound.

Selecting the AUX OUT level [AuxOutLevel]

Select the volume level of the signal output from the AUX OUT jacks. When “Fixed” is selected, the level cannot be controlled by using the [MASTER VOLUME] control. When “Variable” is selected, the level can be controlled by using the [MASTER VOLUME] control.

See the procedure on page 71.

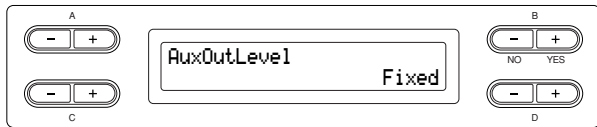

Setting range:

Fixed/Variable

Normal Setting:

Fixed

Setting the MIDI transmit channel [MidiOutChannel]

This parameter enables you to specify the channel on which the Clavinova transmits MIDI data. See the procedure on page 71.

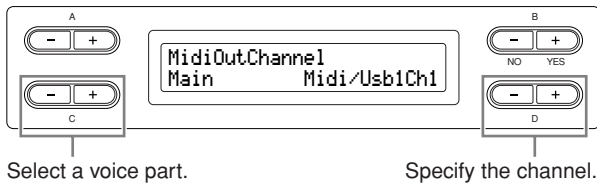

Setting for:

Main, Left, Layer, Left Layer

Setting range:

Midi/Usb1 Ch1 - Ch16, Off (Not transmitted.)

Normal setting:

- Main — Midi/Usb1 Ch1
- Left — Midi/Usb1 Ch2
- Layer — Midi/Usb1 Ch3
- Left Layer — Midi/Usb1 Ch4

Setting the MIDI receive channel [MidiInChannel]

You can specify whether each channel of data from MIDI [IN] and USB [TO HOST] will be received. See the procedure on page 71.

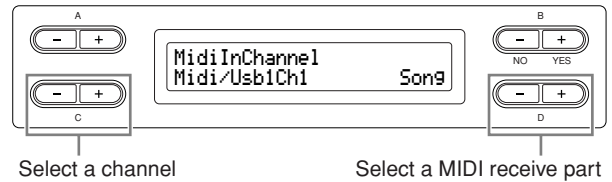

Setting for:

Midi/Usb1 Ch1 - Ch16
Usb2 Ch1 - 16

Setting range:

Song, Main, Left, Layer, LeftLayer, Keyboard, Off

Normal setting:

- Midi/Usb1 Ch1- Ch16 — Song
- Usb2 Ch1 — Keyboard
- Usb2 Ch2 — Main
- Usb2 Ch3 — Left
- Usb2 Ch4 — Layer
- Usb2 Ch5 — LeftLayer
- Others — Off

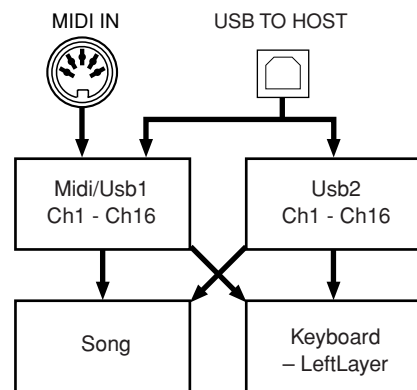

Turning Local control on/off [LocalControl]

“Local Control On” is a state in which the Clavinova produces the sound from its tone generator when you play the keyboard. In “Local Control Off” state, the keyboard and the tone generator are cut off from each other. This means that even if you play the keyboard, the Clavinova will not produce the sound. Instead, the keyboard data can be transmitted via MIDI to a connected MIDI device, which can produce the sound. The “Local Control Off” setting is useful when you wish to play an external sound source while playing the keys on the Clavinova.

See the procedure on page 71.

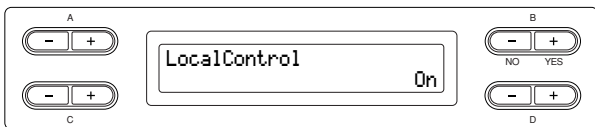

Setting range:

On/Off

Normal setting:

On

Selecting performance from the keyboard or song data for MIDI transmission [MidiOutSelect]

You can select whether your performance data or song playback data is sent via MIDI.

See the procedure on page 71.

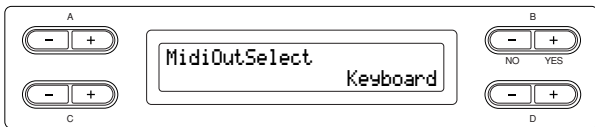

Setting range:

Keyboard performance data played on the keyboard
 Song song playback data

Normal setting:

Keyboard

Selecting a type of data received via MIDI [ReceiveParameter]

This parameter enables you to specify which MIDI data the Clavinova can receive.

See the procedure on page 71.

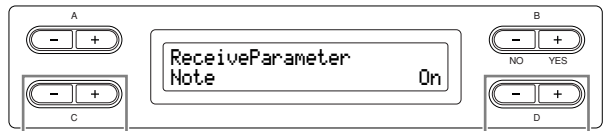

Select a type of data.

Select on or off.

Type of data:

Note, Control, Program, Pitch Bend, SysEx (System Exclusive)

Setting range:

On/Off

Normal setting:

On for all types of data

Selecting a type of data transmitted via MIDI [TransmitParameter]

This parameter enables you to specify which MIDI data the Clavinova can transmit.

See the procedure on page 71.

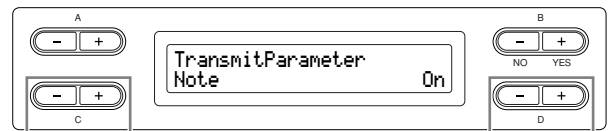

Select a type of data.

Select on or off.

Type of data:

Note, Control, Program, Pitch Bend, SystemRealTime, SysEx (System Exclusive)

Setting range:

On/Off

Normal setting:

On for all types of data

Transmitting the initial settings on the panel [InitialSetup]

You can transmit the panel data, such as voice selection, to a connected sequencer. Before you record performance data to a sequencer, it is useful if you first send and record (at the beginning of the performance data) the panel setup data for your performance during playback. See the procedure on page 71.



Selecting items saved at shutdown [MemoryBackup]

You can back up some settings, such as voice selection and metronome setting, so that they will not be lost after you turn off the power to the Clavinova.

- Memory songs (saved in the Clavinova’s memory), the backup on/off setting (this parameter setting), and the “CharacterCode” parameter setting (page 55) are always backed up. See the procedure on page 71.

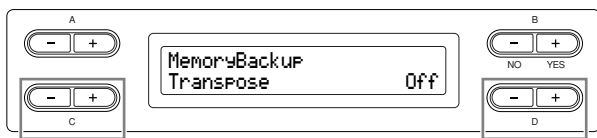

Select the desired item.

Select on or off.

Setting for:

- Transpose
- Brilliance
- ReverbOnOff
- iAfc
- SplitPoint
- Main/LeftVoice
- MetronomeSetting
- File/SongSetting
- MidiSetting (“MidiOutChannel” – “TransmitParameter” in the Function settings)
- Function (except for Transpose, SplitPoint and Midi settings).

Setting range:

On/Off

Normal setting:

The Transpose, Main/LeftVoice, MetronomeSetting, and Function (except for Transpose and SplitPoint setting) parameters are set to Off. Other parameters are set to On.

Restoring the normal (default) settings [FactorySet]

You can reset the Clavinova to its normal (factory default) settings.

- The CharacterCode parameter setting (page 55) does not change.
- The MemoryBackup parameter setting (On/Off) (left column) is reset to the normal setting.
- You can specify whether the memory songs are erased or kept.

See the procedure on page 71.

CAUTION

Do not turn off the power during factory set. Doing so could result in damage to the data.

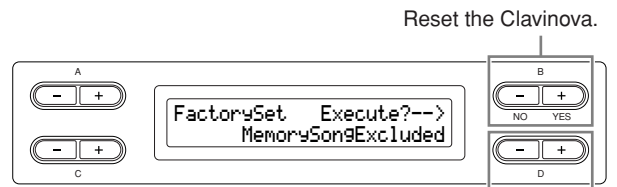

Reset the Clavinova.

Select whether the memory songs are erased or kept.

Selecting for “MemorySong”:

- MemorySongExcluded Memory songs are kept.
- MemorySongIncluded Memory songs are erased.

Other method for restoring the normal settings

Press and hold down the white key on the right end (C7) and press the [POWER] switch to turn on the power to the Clavinova. In this case, the Memory songs saved in the storage memory are not erased.

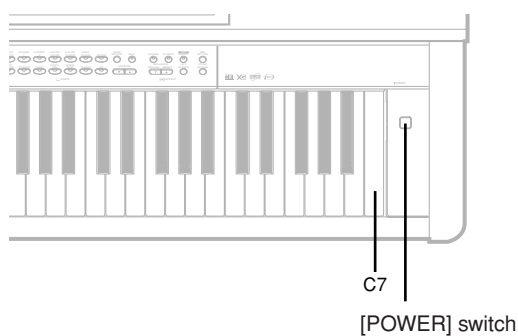

Backing up the Clavinova's internal data [FullBackup]

For maximum data security Yamaha recommends that you copy or save your important data to a USB storage device. This provides a convenient backup if the internal memory is damaged. Perform the operation after connecting the USB storage device. See the procedure on page 71.

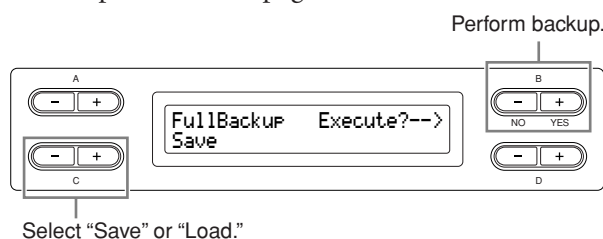

TIP

It's best not to connect several USB storage devices when backing up your data. When several devices are connected, a specific device cannot be identified for saving data.

CAUTION

Do not execute "FullBackup" during file operations such as loading songs. Doing so could result in damage to the data.

TIP

It may take 1 – 2 minutes to complete the backup.

CAUTION

Do not turn off the power during full backup. Doing so could result in damage to the data.

TIP

Protected songs (indicated by MS/Ms in the display) cannot be saved. Move the songs to the USB storage device before executing Full Backup. If you do not move the protected songs and keep the data only in the internal memory, the data will be deleted when you load the backup settings to the instrument.

Message List

The messages are listed in alphabetical order.

Message	Meaning
<div style="border: 1px solid black; padding: 2px; width: fit-content;">AccessError</div> <div style="border: 1px solid black; padding: 2px; width: fit-content;">AccessError</div>	<ul style="list-style-type: none"> This message appears when data has failed to be written or loaded to the Storage memory or USB storage device. When you write or load data via USB storage device, check the USB cable connection and try again. If you still see this message, the Storage memory/media/device may have malfunctioned or may be damaged. This message appears when a Read-Only file is selected to be overwritten. The file cannot to be overwritten.
<div style="border: 1px solid black; padding: 2px; width: fit-content;">AllFiles?--></div>	<p>When you delete a folder, this message asks you whether you want to delete all of the files in that folder. To delete all files in the folder, press the D [+ (YES)] button. To cancel, press the D [- (NO)] button.</p>
<div style="border: 1px solid black; padding: 2px; width: fit-content;">BackupMemoryFull</div>	<p>This message will appear when there is insufficient empty space in backup memory. Turn the power switch off and turn it on again to delete unnecessary backup data.</p>
<div style="border: 1px solid black; padding: 2px; width: fit-content;">CalibrationError DefaultReset</div>	<p>This message means that automatic adjustment of iAFC is not possible and the settings reset to their default values. In this case, perform the automatic adjustment once again.</p>
<div style="border: 1px solid black; padding: 2px; width: fit-content;">Calibration Lid is closed. Open Lid.</div>	<p>This message means that automatic adjustment of iAFC is not possible because the lid is closed or open with the shorter stay. In this case, open the lid with the longer stay using the inner recess.</p>
<div style="border: 1px solid black; padding: 2px; width: fit-content;">Calibration Speaker sound is off</div>	<p>This message means that automatic adjustment of iAFC is not possible because no sound is output from the rear speaker. In this case if the “Speaker” setting is Off, turn “Speaker” On. If “Speaker” is set to Normal and headphones are connected, unplug the headphones.</p>
<div style="border: 1px solid black; padding: 2px; width: fit-content;">Calibration Sure?--> Test sound is output.</div>	<p>This message will appear to confirm start of the iAFC calibration. When calibrating, a test tone will sound from the instrument.</p>
<div style="border: 1px solid black; padding: 2px; width: fit-content;">Canceled</div>	<p>This message confirms that the operation has been cancelled.</p>
<div style="border: 1px solid black; padding: 2px; width: fit-content;">Caution ProtectedSong</div>	<p>This message appears when you do the following operation to a protected song:</p> <ul style="list-style-type: none"> Overwrite (protected songs cannot be overwritten) Save with a new name (protected songs cannot be used with “Save as” function) Delete (this message confirms that the protected song will be deleted) Rename (renamed protected songs may not be played back)

Message	Meaning
Completed	This message is displayed following the message “Executing.” The Clavinova’s internal processing is complete. You may proceed to the next step.
DriveError	This message appears when a communication error occurred between the instrument and drive. Check the USB cable connection and try again. If you still see this message, use a drive whose compatibility has been confirmed by Yamaha (page 62).
DriveNumLimitOver	The number of drives exceeds the limitation. Two USB storage devices can be connected to one USB [TO DEVICE] terminal using a hub device. This instrument can recognize up to four drives in one USB storage device.
DrivePowerError	The connection has been cut off because of an abnormal power surge to the drive. To recover from this, turn the power switch of the hub off and on again, or disconnect the USB storage device from the instrument and turn the power switch of the instrument off and on again.
DriveRemoved	This message appears when the USB storage device is removed from the instrument.
DuplicateName	When you attempted to rename a song and save it in “Rename” (page 50), this message will appear if an identically-named song already exists. Three seconds after this message is displayed, you will return to the previous screen. Please specify a different name.
Execute?-->	This message prompts you to execute a file-related operation. Press the B [+ (YES)] button to proceed, or press the [EXIT] button to cancel.
Executing	The Clavinova is processing the data internally. Wait until the message disappears, then proceed to the next step.
FactorySet Completed Restart	This message appears when factory set is completed. The instrument is then restarted.
FactorySet Executing MemorySongExcluded	The normal (factory default) settings (including the memory song setting) (“FactorySet” on page 93) have been restored. This message also appears if you press and hold down the C7 and turn on the power to the Clavinova (page 94).
FactorySet Executing MemorySongIncluded	The normal (factory default) settings (except for the memory song setting) (“FactorySet” on page 93) have been restored.
FullBackup Completed Restart	This message will appear when loading of the backup file is completed. The instrument is then restarted.

Message	Meaning
HostError	<p>There is a problem with the USB [TO HOST] terminal</p> <ul style="list-style-type: none"> When using the CLP-295GP connected to your personal computer: The driver or MIDI application on your computer is not functioning correctly, perhaps because the computer is turned off, the cable is not connected correctly. In this case, turn off the power of the CLP-295GP and your computer, and check the cable connections. Then turn on the power in the order of your computer → CLP-295GP, and check that the driver and MIDI application on your computer are functioning correctly. When using the CLP-295GP by itself: This message may appear if a cable is left connected to the USB [TO HOST] terminal of the CLP-295GP. In this case, turn off the power of the CLP-295GP, disconnect the cable, and then turn on the power again. If the cable is left connected, the CLP-295GP may not function correctly.
LastPowerOffIllegal MemoryChecking	<p>This message will appear when the power is turned on after turning off the power while saving a song or internal settings. The internal memory is being checked while this message appears. If the internal settings are damaged, they will be reset to the initial settings. If Memory songs are damaged, they will be deleted.</p>
MakeDir ---:Select USB Drive	<p>This message appears when you attempt to create a folder to a USB storage device that cannot be accessed. Check that the USB storage device is connected to the instrument and that the [SELECT] switch specifies the appropriate device, then try again.</p>
MemoryFull	<p>There is not enough memory space left and you cannot save any more songs. Save songs to an external device (page 48) or delete some songs in the storage memory, then save new data to memory.</p>
NoDrive	<p>A USB storage device was not connected to the instrument when you attempted to perform a drive-related function. Connect the device and continue.</p>
NoFile	<ul style="list-style-type: none"> This message will appear when there is no file to load from the media, even if the file name is displayed. Securely insert the media. This message will appear when two-byte letters are included in the file name.
NoSongToCopy	<p>You tried to copy a song that does not exist in the Storage memory or on USB storage device. Select a Memory song or External song via the [SONG SELECT] button.</p>
NoSongToMove	<p>You tried to move a song that does not exist in the Storage memory or on USB storage device. Select a Memory song or External song via the [SONG SELECT] button.</p>

Message	Meaning
NoSongToRename	You tried to rename a song that does not exist in the Storage memory or on USB storage device. Select a Memory song or External song via the [SONG SELECT] button.
Overwrite?-->	This message prompts you to select whether you wish to overwrite the existing data with new data. Press the B [+ (YES)] button to allow overwriting. Press the B [- (NO)] button to cancel.
PC<->CLP InCommunication	This message appears when Musicsoft Downloader is started on a computer connected to the instrument. When this message appears, you cannot operate the instrument.
PleaseWait	You tried to start playing a song or perform another operation right after you select the song. Wait until the message disappears.
ProtectedDrive	This message appears when you try to write (save), copy, or delete data on a protected drive/media. Set protect to off and try again. If you still see this message, the disk is internally protected (such as commercially available music data). You cannot write or copy to such a disk.
ProtectedDriveError	This message appears when a protected song and the drive are not compatible. Use a drive whose compatibility has been confirmed by Yamaha (page 62).
ProtectedFile	You tried to copy or delete data in internally-protected files (such as commercially available music data). You cannot write to, copy, or delete such files.
ProtectedFileFormatError	This message appears when you play back a protected song which has a file format error.
ProtectedSong	After you load an internally-protected song into the Clavinova's Current memory or storage memory, you tried to save the song to a USB storage device. You cannot save such a song to another disk. You cannot write or copy to such a disk.
ProtectedSong:UseMove	This message appears when you copy a protected song. Protected songs cannot be copied. However, you can move the song (page 53).
SecuritySongIsProtected CannotSave	This message appears when you attempt to save a protected song (security song). Protected songs cannot be saved.
Set?-->	This message prompts you to select whether you wish to save the edited settings. Press the B [+(YES)] button to save the settings. Press the [EXIT] button to cancel.

Message	Meaning
SongChanged Clear?	This message appears when you record or edit the protected song and select another song. The recorded/edited protected song cannot be saved. The song will be deleted when you select another song.
SongChanged Save?	You tried to perform another operation before saving the recorded song to storage memory or an external device. If you continue the operation, the recorded song will be lost. To delete the new recording, press the B [- (NO)] button. To keep the recording, press the B [+ (YES)] button. The Clavinova displays the "Save" parameter screen. Save the recorded song and proceed to another operation.
SongError	This message will appear if a problem is found with the song data when you select a song or while the song is playing. In this case, reselect the song, and try once again to play it back. If the message still appears, the song data may have been damaged.
SongTooBig	<ol style="list-style-type: none"> 1. This message will be displayed if current memory fills up during recording. Recording will stop automatically at this point. The data that had been recorded up to that point will remain. This message will also be displayed when you attempt to enter Record mode for additional recording if that song already occupies all of current memory. In this case, additional recording will not be possible. If there is an already-recorded part that you do not need to keep, you can use "ChannelClear" (page 75) to delete the unneeded part, so that you will then be able to record the equivalent amount of additional material. 2. This message will be displayed when you select a song if that song is larger than the capacity of the current memory (page 102). This song cannot be loaded into the CLP-295GP, and cannot be played back. Please select a different song.
Start?-->	This message prompts you to start the operation. To start, press the B [+ (YES)] button. Press the [EXIT] button to cancel the operation.
Sure?-->	This message prompts you to confirm the execution. Press the B [+ (YES)] button to continue. Press the B [- (NO)] button to cancel.
SystemLimit	This message appears when the number of files and folders exceeds the system limit. The maximum number of files/folders which can be stored in a folder is 250. Try again after deleting/moving the unnecessary file(s).
UnformattedDrive	You tried to perform a file- or drive-related operation using an unformatted media. Eject the media, format it using the "Format" parameter (page 54), then try again.

Message	Meaning
<div style="border: 1px solid black; padding: 5px; width: fit-content;">UnformattedDrive Format?</div>	<p>You tried to perform a file- or drive-related operation using an unformatted media. To cancel the operation, press the B [- (NO)] button. To format the disk and try again, press the B [+ (YES)] button to display the format parameter (page 54).</p>
<div style="border: 1px solid black; padding: 5px; width: fit-content;">UnsupportedDrive</div>	<p>This message appears when you connect an unsupported drive. Use a drive whose compatibility has been confirmed by Yamaha (page 62).</p>
<div style="border: 1px solid black; padding: 5px; width: fit-content;">WrongDrive</div>	<ul style="list-style-type: none"> • The connected drive does not support use of protected songs. Use only drives whose compatibility has been confirmed by Yamaha (page 62). • This message appears when the connected USB storage device is damaged and cannot be accessed.
<div style="border: 1px solid black; padding: 5px; width: fit-content;">WrongName</div>	<p>You used a period or space at the beginning of a song name or you tried to change a song name that includes a character (or characters) not supported by the CLP-295GP, and the CLP-295GP could not process the name. The Clavinova displays the previous screen in three seconds. Rename the song correctly.</p>
<div style="border: 1px solid black; padding: 5px; width: fit-content;">WrongSelection</div>	<p>This message appears when, in copying a song, the same folder has been selected for both the source and destination. You cannot select the same folder for both the source and destination. Select the different folder as the destination folder.</p>

Questions about Operations and Functions

■ The buttons do not respond.

While you are using a function, some buttons not used for the function are disabled. If the song is playing, stop the playback. Otherwise, press the [EXIT] button to return to the main screen. Then, perform the desired operation.

■ The sound sustains indefinitely and does not decay when I press the sostenuto pedal.

With the voices in the CHURCH ORGAN, JAZZ ORGAN, STRINGS, CHOIR group, or some voices in the XG group, the sound continues sustaining while you are holding down the sostenuto pedal.

■ Higher or lower notes does not sound correctly when the transpose or octave setting is made.

The setting range for the transposition and octave setting is C-2 - G8. (With the normal setting, the Clavinova's 88 keys covers the range of A-1 - C7.) If the lowest key is set to a note lower than C-2, it will produce a sound one octave higher. If the highest key is set to a note higher than G8, it will produce a sound one octave lower.

■ How can I return to the recording or song select screen during song recording or playback?

Press the [SONG SELECT] button once.

■ The tempo does not change even though I recorded with tempo changes.

Depending on the timing of tempo changes, the changed tempo may not be recorded. In this case, the recording will be played back at the original tempo.

Make tempo changes when the recording part is selected and a red part indicator is flashing. The same trick applies to editing the tempo after recording.

■ Performance in Dual or Split mode is not recorded.

■ Part data is lost unexpectedly.

For Dual or Split mode recording, the recording part for the second voice (that is, the voice for the left-hand part) is automatically assigned (page 31).

Therefore, if the part already has data, the data will be overwritten during recording. Also, switching to Dual mode or Split mode in the middle of the song is not recorded. Therefore, the notes you played with the second voice (or the notes lower than the Split point) are not recorded.

■ What type of data is recorded?

Data recorded in the parts:

- Note data (notes you play)
- Voice selection
- Clavinova pedals and external pedal on/off
- Reverb depth [ReverbSend]
- Chorus depth [ChorusSend]
- DSP effect depth [DSPDepth]
- Sound brightness [Brightness]
- Resonance effect setting [HarmonicContent]
- Equalizer's low-range frequency setting [EQLowFreq.]
- Equalizer's low-range gain setting [EQLowGain]
- Equalizer's high-range frequency setting [EQHighFreq.]
- Equalizer's high-range gain setting [EQHighGain]
- Octave setting of the voice [Octave]
- Volume setting of each voice [Volume]
- Left/right position of each sound [Pan]
- Fine pitch adjustment between two voices (Dual only) [Detune]
- Volume change in response to playing strength for each voice [TouchSense]

Data recorded globally in all parts:

- Tempo
- Time signature
- Reverb type
- Chorus type
- DSP effect type

You can change all data except for note data, Octave setting or Time Signature after recording.

■ How much data can I record?

- Current memory (page 48): About 300KB
- Storage memory (page 48): About 1,750KB

■ The on/off setting of the pedal connected to the AUX PEDAL jack is reversed.

Some types of pedals may turn on and off in opposite fashion. Use the “AuxPedalType” parameter (page 88) in the “FUNCTION” menu to change the external pedal setting.

■ The song title is not correct.

The “CharacterCode” setting may be different than that used when you named the song. Also, if the song was recorded on another instrument, the title might be displayed incorrectly. Use the “CharacterCode” parameter (page 55) in the FILE/SONG SETTING menu to change the setting. However, if the song was recorded on another instrument, changing the “CharacterCode” parameter setting may not resolve the problem.

■ What is the difference between “TouchSense” and “TouchResponse” MIDI data?

“TouchSense” determines the manner and degree to which the volume level changes in response to your touch on the keyboard. The MIDI note-on velocity data is not changed. It changes the volume level at the same velocity data.

“TouchResponse” determines the touch sensitivity of an instrument. The MIDI note-on velocity data is changed when you play the keyboard with a consistent touch.

■ Only “PhraseMark” can be selected via the [FILE/SONG SETTING] button during song playback.

The “PhraseMark” parameter can only be set via the [FILE/SONG SETTING] button during song playback. If you desired to select other parameters, stop the song and try once again.

Appendix

Troubleshooting

Problem	Cause	Solution
The power of the Clavinova does not turn on.	The power cable is not plugged in (check at the Clavinova and at the electrical outlet).	Insert the power cable plug firmly into the Clavinova and into the electrical outlet of the correct voltage. (page 16)
There is a clicking noise when you press the [POWER] button to turn the power on or off.	This is caused by the electrical power within the instrument.	This is not a malfunction.
Noise is heard from the Clavinova.	A portable telephone is being used near the Clavinova (or the ring tone is sounding).	Turn off the power of the portable telephone located near the Clavinova. Noise may be heard if a portable telephone is used near the Clavinova or if the ring tone occurs.
The overall volume is too low. Or, there is no sound at all.	The [MASTER VOLUME] dial is lowered.	Raise the [MASTER VOLUME] dial. (page 17)
	The volume level for the keyboard performance is set too low.	Move the [SONG BALANCE] slider toward the keyboard to increase the keyboard volume.
	Headphones are connected (only if the Speaker setting is "Normal HeadphoneSW"). (page 90)	Disconnect the headphone plug.
	Speaker setting is off.	Set [Speaker] to "Normal" or "ON". (page 90)
	Local Control is turned off.	Set Local control ON. (page 92)
	"Expression" is assigned to the right pedal or the AUX pedal.	Assign any function other than "Expression" to the pedal.
The keyboard volume is lower than the song playback volume.	The volume level for the keyboard performance is set too low.	Move the [SONG BALANCE] slider toward the keyboard to increase the keyboard volume.
Sound is still heard from the speakers even though headphones are plugged in.	Speaker setting is On.	Set the speaker setting to "Normal (HeadphoneSW)". (page 90)
iAFC cannot be turned ON.	The lid is closed or open with the shorter stay.	Open the lid with the longer stay using the inner recess.
Feedback occurs when you turn iAFC on.	iAFC was not automatically adjusted correctly.	Turn iAFC OFF, and perform the automatic adjustment (page 84)
Damper pedal does not function, or notes are sustained even though the damper pedal is not pressed.	The plug of the pedal cable is not inserted into the [PEDAL] jack.	Plug the pedal cable firmly into the [PEDAL] jack. (Refer to "CLP-295GP: Keyboard Stand Assembly" beginning on page 111.)

Problem	Cause	Solution
<p>The USB storage device is not recognized by the instrument.</p>	<p>The USB storage device may not be recognized by the instrument depending on the timing of the device connection or the setting of the [SELECT] switch.</p>	<p>Disconnect the USB storage device and connect it again and select a device using the [SELECT] switch. To view the data of the USB storage device on the CLP display, press the [SONG SELECT] button to engage song selection mode or press the [FILE/SONG SETTING] button to engage file/song setting mode. If you try to engage these modes before connecting the USB storage device, press the [EXIT] button to exit the mode and re-engage the mode. If the device is still not recognized, it may not be supported by Yamaha. Only use devices supported by Yamaha (page 62).</p>
<p>The USB storage device has hung up (stopped).</p>	<p>The USB storage device is not compatible with the instrument.</p>	<p>Only use devices whose compatibility has been confirmed by Yamaha (page 62).</p>
	<p>The USB storage device does not operate properly.</p>	<p>Disconnect the device and connect it to the instrument again.</p>

Data Compatibility

This section covers basic information on data compatibility: whether or not other MIDI devices can playback the data recorded by CLP-295GP, and whether or not the CLP-295GP can playback commercially available song data or song data created for other instruments or on a computer.

Depending on the MIDI device or data characteristics, you may be able to play back the data without any problem, or you may have to perform some special operations before the data can be played back. If you run into problems playing back data, please refer to the information below.

Basic Check Points

The data and the MIDI device must match in regards to the items below.

- Sequence format
- Voice allocation format
- Disk Format (floppy disk drive is optional)

Sequence Format

The system which records song data is called “sequence format.”

Playback is only possible when the sequence format of the disk matches that of the MIDI device.

The CLP-295GP is compatible with the following formats.

■ SMF (Standard MIDI File)

This is the most common sequence format.

- Standard MIDI Files are generally available as one of two types: Format 0 or Format 1.
- Many MIDI devices are compatible with Format 0, and most commercially available software is recorded as Format 0.
- The CLP-295GP is compatible with both Format 0 and Format 1.
- Performance data recorded on the CLP-295GP is saved in the SMF format 0.

■ ESEQ

This sequence format is compatible with many of Yamaha’s MIDI devices, including the Clavinova series instruments. This is a common format used with various Yamaha software.

Voice Allocation Format

With MIDI, voices are assigned to specific numbers, called “program numbers.” The numbering standard (order of voice allocation) is referred to as the “voice allocation format.”

Voices may not play back as expected unless the voice allocation format of the song data matches that of the compatible MIDI device used for playback.

The CLP-295GP is compatible with the following formats.

■ GM System Level 1

This is one of the most common voice allocation formats.

Many MIDI devices are compatible with GM System Level 1, as is most commercially available software.

■ GM System Level 2

“GM System Level 2” is a standard specification that enhances the original “GM System Level 1” and improves song data compatibility. It provides for increased polyphony, greater voice selection, expanded voice parameters, and integrated effect processing.

■ XG

XG is a major enhancement of the GM System Level 1 format, and was developed by Yamaha specifically to provide more voices and variations, as well as greater expressive control over voices and effects, and to ensure compatibility of data well into the future.

Song data recorded on the CLP-295GP using voices in the XG category is XG-compatible.

■ DOC (Disk Orchestra Collection)

This voice allocation format is compatible with many of Yamaha's MIDI devices, including the Clavinova series instruments.

This is also common format used with various Yamaha software.

■ GS

GS was developed by the Roland Corporation.

In the same way as Yamaha XG, GS is a major enhancement of the GM specifically to provide more voices and drum kits and their variations, as well as greater expressive control over voices and effects.

Even if the devices and data used satisfy all the conditions above, the data may still not be completely compatible, depending on the specifications of the devices and particular data recording methods.

Disk format

It is necessary to first configure the floppy disk to the system of the device being used. This operation is called "formatting."

- There are two types of floppy disks: MF2DD (double sided, double density) and MF2HD (double sided, high density), and each type has different formatting systems.
- Playback is only possible when the MIDI device to be used is compatible with the format of the disk.

Preset Voice List

○: Yes ×: No

Voice group	Voice name	Stereo sampling	Touch Sense	Dynamic sampling	Key-off samples	String resonance	Voice description
GRAND PIANO1	GrandPiano1	○	○	○	○	○	This sound was sampled from a full concert grand piano. Three stages of dynamics were sampled, and no effort has been spared in making the sound virtually identical to that of an acoustic piano. Even the tonal changes produced by the damper pedal and the subtle sounds of releasing a key are reproduced. The sympathetic vibration (string resonance) that occurs between the strings of an acoustic piano has also been simulated. Suitable not only for classical compositions but also for piano pieces of any style.
	MellowPiano	○	○	○	○	○	A warm and mellow piano sound. Ideal for classical music.
	RockPiano	○	○	○	○	○	A bright-sounding piano. Ideal for rock styles.
	HonkyTonk Piano	○	○	○	○	×	A honky-tonk style piano. Enjoy a tonal character that is quite different than a grand piano.
GRAND PIANO2	GrandPiano2	○	○	×	×	×	A spacious and clear piano sound with a bright resonance. Ideal for popular music.
	BrightPiano	○	○	×	×	×	A spacious and bright piano sound. Ideal for popular and rock music.
E.PIANO1	E.Piano1	×	○	○	×	×	An electronic piano sound produced by an FM synthesizer. The tone will change as you vary your playing touch. Ideal for popular music.
	SynthPiano	×	○	×	×	×	This voice simulates the electric piano sound produced by synthesizers in popular music. It also goes well with the acoustic piano sound.
E.PIANO2	E.Piano2	×	○	○	○	×	The sound of an electric piano using hammer-struck metallic "tines." Soft tone when played lightly, and an aggressive tone when played hard.
	Vintage E.Piano	×	○	○	×	×	A different type of electric piano sound. Widely used in rock and popular music.
HARPSICHORD	Harpsichord 8'	○	×	×	○	×	The sound of the instrument frequently used in baroque music. Variations in playing touch will not affect the volume, and a characteristic sound will be heard when you release the key.
	Harpsichord 8'+4'	○	×	×	○	×	A harpsichord with an added upper octave. Produces a more brilliant sound.
E.CLAVICHORD	E.Clavichord	×	○	×	○	×	This is the voice of a keyboard that produces sound by striking the strings with magnetic pickups. This funky sound is popular in black contemporary music. Because of its unique structure, the instrument produces a peculiar sound when you release the keys.
	Wah Clavi.	×	○	×	○	×	A distinctive effect is preset.
VIBRA-PHONE	Vibraphone	○	○	○	×	×	Vibraphone played with relatively soft mallets. The tone becomes more metallic the harder you play.
	Marimba	○	○	×	×	×	A marimba sound, sampled in stereo for spaciousness and realism.
	Celesta	○	○	○	×	×	The sound of a celesta (a percussion instrument in which hammers strike metallic bars to produce sound). This instrument is well-known for its appearance in "Dance of the Sugar-plum Fairies" from Tchaikovsky's "Nutcracker Suite."

Voice group	Voice name	Stereo sampling	Touch Sense	Dynamic sampling	Key-off samples	String resonance	Voice description
GUITAR	NylonGuitar	○	○	○	×	×	A warm and natural nylon-string guitar sound. Enjoy the atmosphere it adds to a quiet song.
	SteelGuitar	×	○	×	×	×	A bright steel guitar sound. Ideal for popular music.
CHURCH ORGAN	PipeOrgan Principal	○	×	×	×	×	This voice features the combination of pipes (8'+4'+2') of a principal (brass instrument) organ. It is suitable for Baroque church music.
	PipeOrgan Tutti	○	×	×	×	×	This voice features a full coupler of a pipe organ, famous for the sound used in Toccatta and Fugue by Bach.
	PipeOrgan Flute1	○	×	×	×	×	A pipe organ sound that combines flute-type (woodwind type) stops of different pitches (8' + 4'). This is a gentle sound that is ideal for accompanying hymns.
	PipeOrgan Flute2	○	×	×	×	×	A pipe organ sound that combines flute-type (woodwind type) stops of different pitches (8' + 4' + 1-1/3'). This is brighter than PipeOrganFlute1, and is suitable for solos.
JAZZORGAN	JazzOrgan	×	×	×	×	×	The sound of a "tonewheel" type electric organ. Often heard in jazz and rock idioms.
	RotaryOrgan	×	×	×	×	×	A bright electric organ sound.
	MellowOrgan	×	×	×	×	×	A mellow electric organ sound. Ideal for calmer songs.
STRINGS	Strings	○	○	×	×	×	Stereo-sampled, large-scale strings ensemble with realistic reverb. Try combining this voice with piano in the Dual mode.
	SynthStrings	×	○	×	×	×	A bright and spacious strings sound. Suitable for sustained parts in the background of an ensemble.
	SlowStrings	○	○	×	×	×	The sound of a string ensemble, with a slow attack. Suitable for use in Dual mode with GRAND PIANO or E.PIANO.
CHOIR	Choir	×	○	×	×	×	A big, spacious choir voice. Perfect for creating rich harmonies in slow pieces.
	SlowChoir	×	○	×	×	×	The sound of a choir with a slow attack. Suitable for use in Dual mode with GRAND PIANO or E.PIANO.
	Scat	×	○	○	×	×	You can enjoy jazz "scatting" with this voice. Depending on how hard and what note range you play, different sounds will be produced.
SYNTH.PAD	SynthPad1	×	○	×	×	×	A warm, mellow, and spacious synth sound. Ideal for sustained parts in the background of an ensemble.
	SynthPad2	×	○	×	×	×	A clear and spacious synth sound. Ideal for sustained parts in the background of an ensemble.
WOOD BASS	WoodBass	×	○	○	×	×	The sound of a finger-plucked upright bass. Frequently used in jazz and Latin music.
	Bass&Cymbal	×	○	○	×	×	The sound of a cymbal has been layered onto the bass. Effective when used for jazz walking-bass lines.
E.BASS	ElectricBass	×	○	×	×	×	The sound of an electric bass. Frequently used in jazz, rock, and popular music.
	FretlessBass	×	○	×	×	×	The sound of a fretless bass. Suitable for styles such as jazz and fusion.

Voice Combination Examples (Dual and Split)

Dual

MAIN + MAIN	GrandPiano1 + E.Piano1 GrandPiano1 + E.Piano2	This combination is often used in popular music.
MAIN + MAIN	GrandPiano1 + SynthPiano	This produces a fantasy, spacious piano sound.
MAIN + MAIN	GrandPiano2 + GrandPiano2	This combination sounds as if you are playing two notes that are one octave apart. It is suitable for the accompaniment of Salsa music.
MAIN + MAIN	E.Piano1 + SlowChoir	This is suitable for romantic ballads.
MAIN + MAIN	E.Piano2 + E.Clavichord	This is suitable for funk, rhythm & blues, and soul music.
MAIN + MAIN	Harpichord8' + Strings	This combination is very suitable for Baroque music.
MAIN + MAIN	Celesta + SynthStirngs	This combination adds strings and bell sound. A delay effect is automatically applied.

Split

MAIN / LEFT	GrandPiano1 / WoodBass or Bass&Cymbal	This is recommended for light Jazz music. The damper pedal is effective on the voice assigned to the right-hand range.
MAIN / LEFT	Celesta / Choir	This is suitable for a peaceful, somewhat cute song.
MAIN / LEFT	Choir / GrandPiano1	Play these voices elegantly along with piano arpeggio. Playing the Choir voice in chords would be more effective.
MAIN / LEFT	Scat / WoodBass	This combination features a cool (stylish) jazz chorus. The Scat voice is touch sensitive, adding a variety of expressions.
MAIN / LEFT	E.Piano2 / Scat	Playing the Scat voice for a bass part may create an interesting sound.

Dual + Split

MAIN + MAIN / LEFT	GrandPiano1 + SynthString / GrandPiano1	This combination creates the thick sound of a layered piano and strings.
MAIN + MAIN / LEFT	GrandPiano2 + E.Piano1 / ElectricBass	This sound is suitable for fusion. Deeper reverb and chorus (page 79) will improve the groove. The damper pedal is effective on the voice assigned to the right-hand range.
MAIN + MAIN / LEFT + LEFT	Harpichord8' + 4' + Strings / Harpichord8' + Strings	This combination makes a very brilliant sound.

CLP-295GP: Keyboard Stand Assembly

⚠ CAUTION

- Be careful not to confuse parts, and be sure to install all parts in the correct orientation. Please assemble in accordance with the sequence given below.
- Assembly should be carried out by at least two persons.
- Be sure to use the correct screw size, as indicated below. Use of incorrect screws can damage the stand.
- Be sure to tighten all screws upon completing the assembly of each unit.
- To disassemble, reverse the assembly sequence given below.

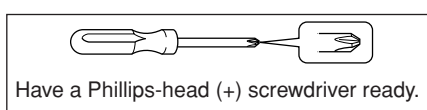

TIP

The CLP-295GP features an iAFC (Instrumental Active Field Control) effect. This produces sound from the speaker located on the bottom face of the Clavinova, enhancing the reverberation and spaciousness of the sound when you open the lid with the longer stay (page 15).

In order to optimize the iAFC effect, please observe the following:

- Perform the automatic adjustment after you turn on the power of the Clavinova for the first time, and after each time you re-locate the Clavinova. (page 84)
- Do not block the speaker located on the bottom face of the Clavinova.

1. Remove all parts from the box. Confirm that all parts shown in the illustration are included.

Main unit

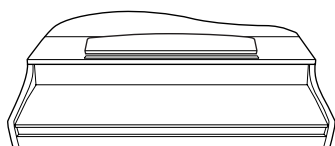

Lean the unit against the wall as shown at right.

Legs

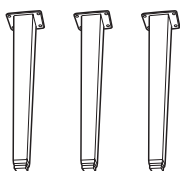

Pedal box

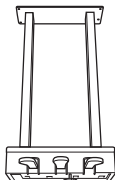

6 × 40 mm fixing screws
× 12



AC power cord



Cord holder



6 × 20 mm fixing screws
× 4



How to position the main unit

⚠ CAUTION

Be careful not to pinch your fingers.

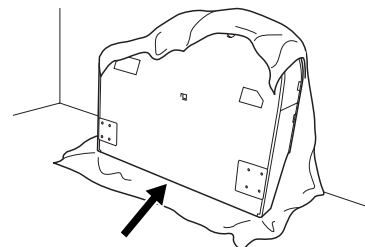

Be sure to position the keyboard side on the bottom.

Spread a large soft cloth, such as a blanket, on the floor. Place the unit on the cloth with the key cover closed and the keyboard side on the bottom and lean the unit against the wall so that the unit will not fall or slip. Place a soft cloth against the wall to protect the instrument and the wall from scratches.

⚠ CAUTION

Do not place the main unit with the rear side facing down.

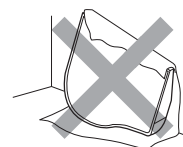

⚠ CAUTION

Do not lay the main unit upside down on the floor.

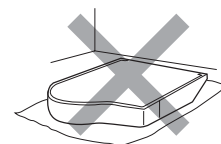

⚠ CAUTION

Do not position the main unit so that its bottom is in contact with floor.

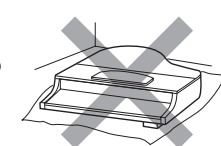

2. Attach two front legs and a rear leg.

Refer to the diagram below to verify the orientation of the legs.

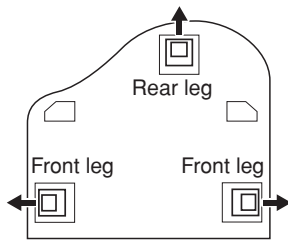

Install and tighten four 6 x 40 mm screws on each leg, starting with one of the front legs.

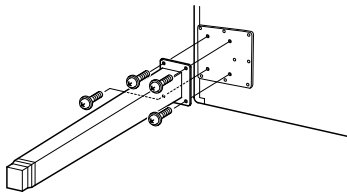

3. Install the pedal box.

- 1 Remove the twist tie that affixes the pedal cord to the upper portion of the pedal box.

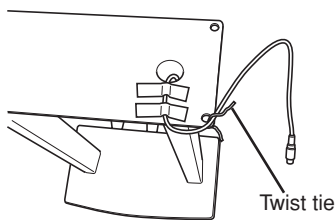

- 2 Align the cord with the groove on the unit, and attach the pedal box using four 6 x 20 mm screws.

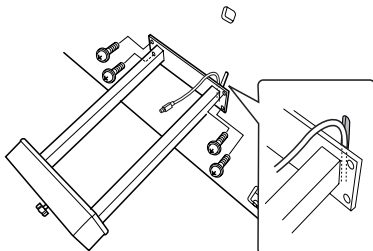

- 3 Insert the pedal cord plug into the pedal connector. Insert the plug so the arrow side faces front (toward the keyboard). If the plug will not go in easily, do not force it. Double-check the orientation of the plug, then try again.

- 4 Attach the cord holder on the unit as shown in the illustration below, then use the cord holder to affix the pedal cord.

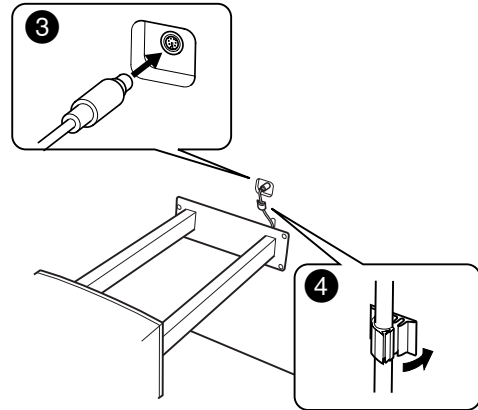

4. Raising the unit to the standing position.

Use the front legs as support to raise the unit.

⚠ CAUTION

- Be careful not to pinch your fingers.
- When you raise the unit, do not hold the key cover.

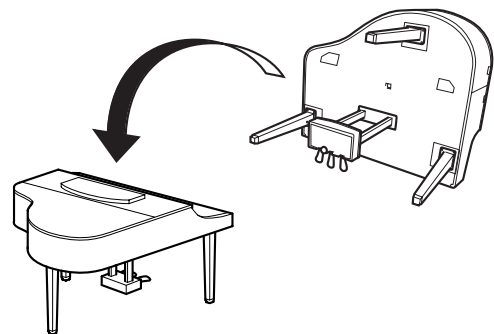

5. Connect the power cord.

Insert the AC power cord plug into the [AC INLET].

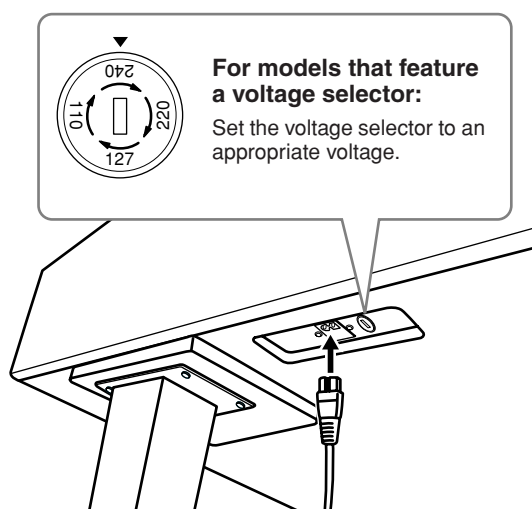

Right leg on the bottom of the main unit, when viewed from front

Voltage Selector

Before connecting the AC power cord, check the setting of the voltage selector which is provided in some areas. To set the selector for 110V, 127V, 220V or 240V main voltages, use a “minus” screwdriver to rotate the selector dial so that the correct voltage for your region appears next to the pointer on the panel. The voltage selector is set at 240V when the unit is initially shipped.

After the proper voltage has been selected, connect the AC power cord to the [AC INLET] and an AC wall outlet. A plug adaptor may be also provided in some areas to match the pin configuration of the AC wall outlets in your area.

⚠ WARNING

An improper voltage setting can cause serious damage to the Clavinova or result in improper operation.

6. Set the adjuster.

Rotate the adjuster until it comes in firm contact with the floor surface.

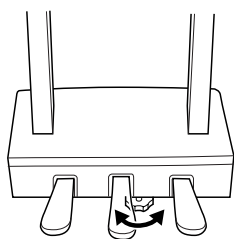

After completing the assembly, please check the following.

- **Are there any parts left over?**
→ Review the assembly procedure and correct any errors.
- **Is the Clavinova clear of doors and other movable fixtures?**
→ Move the Clavinova to an appropriate location.
- **Does the Clavinova make a rattling noise when you shake it?**
→ Tighten all screws.
- **Does the pedal box rattle or give way when you step on the pedals?**
→ Turn the adjuster so that it is set firmly against the floor.
- **Are the pedal and power cords inserted securely into the sockets?**
→ Check the connection.
- **If the main unit creaks or is otherwise unsteady when you play on the keyboard, refer to the assembly diagrams and retighten all screws.**

When moving the instrument after assembly, always hold the bottom of the main unit.

⚠ CAUTION

Do not hold the key cover or top portion. Improper handling can result in damage to the instrument or personal injury.

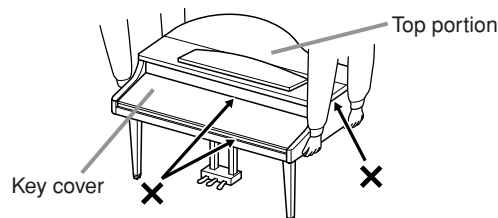

Handling the Floppy Disk Drive (FDD) and Floppy Disks (Optional)

An optional floppy disk drive can be installed to this instrument. For instructions on installing the floppy disk drive, see page 115.

The floppy disk drive lets you save original data you've created on the instrument to floppy disk, and allows you to load data from floppy disk to the instrument.

Be sure to handle floppy disks and treat the disk drive with care. Follow the important precautions below.

Floppy Disk Compatibility

- 3.5" 2DD and 2HD type floppy disks can be used.

Formatting a Floppy Disk

- If you find that you are unable to use new, blank disks or old disks that have been used with other devices, you may need to format them. For details on how to format a disk, see page 54. Keep in mind that all data on the disk will be lost after formatting. Make sure to check beforehand whether or not the disk contains important data.

NOTE

Floppy disks formatted on this device may or may not be useable as is on other devices.

Inserting/Removing Floppy Disks

Inserting a Floppy Disk into the Disk Drive:

Hold the disk so that the label of the disk is facing upward and the sliding shutter is facing forward, towards the disk slot. Carefully insert the disk into the slot, slowly pushing it all the way in until it clicks into place and the eject button pops out.

NOTE

Never insert anything but floppy disks into the disk drive. Other objects may cause damage to the disk drive or floppy disks.

Removing a Floppy Disk

- After checking that the instrument is not accessing* the floppy disk (checking that the use lamp on the floppy disk drive is off), firmly press the eject button at the upper right of the disk slot all the way in.

When the floppy disk is ejected, pull it out of the drive. If the floppy disk cannot be removed because it is stuck, do not try to force it, but instead try pressing the eject button again, or try re-inserting the disk and attempt to eject it again.

* Access of the disk indicates an active operation, such as recording, playback, or deletion of data.

If a floppy disk is inserted while the power is on, the disk is automatically accessed, since the instrument checks whether the disk has data.

CAUTION

Do not remove the floppy disk or turn off the instrument itself while the disk is being accessed.

Doing so may result not only in loss of data on the disk but also damage to the floppy disk drive.

- Be sure to remove the floppy disk from the disk drive before turning off the power. A floppy disk left in the drive for extended periods can easily pick up dust and dirt that can cause data-read and -write errors.

Cleaning the Disk Drive Read/Write Head

- Clean the read/write head regularly. This instrument employs a precision magnetic read/write head which, after an extended period of use, will pick up a layer of magnetic particles from the disks used that will eventually cause read and write errors.
- To maintain the disk drive in optimum working order Yamaha recommends that you use a commercially-available dry-type head cleaning disk to clean the head about once a month. Ask your Yamaha dealer about the availability of proper head cleaning disks.

About Floppy Disks

Handle floppy disks with care, and follow these precautions:

- Do not place heavy objects on a disk or bend or apply pressure to the disk in any way. Always keep floppy disks in their protective cases when they are not in use.
- Do not expose the disk to direct sunlight, extremely high or low temperatures, or excessive humidity, dust or liquids.
- Do not open the sliding shutter and touch the exposed surface of the floppy disk inside.
- Do not expose the disk to magnetic fields, such as those produced by televisions, speakers, motors, etc., since magnetic fields can partially or completely erase data on the disk, rendering it unreadable.
- Never use a floppy disk with a deformed shutter or housing.
- Do not attach anything other than the provided labels to a floppy disk. Also make sure that labels are attached in the proper location.

To Protect Your Data (Write-protect Tab):

- To prevent accidental erasure of important data, slide the disk's write-protect tab to the "protect" position (tab open). When saving data, make sure that the disk's write-protect tab is set to the "overwrite" position (tab closed).

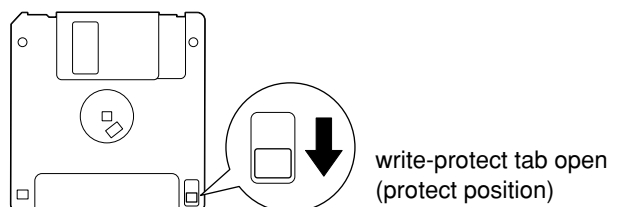

Installing the Floppy Disk Drive (Optional)

The optional UD-FD01 floppy disk drive can be installed to the bottom of the instrument by using the included floppy disk drive case and screws.

Have a Phillips-head (+) screwdriver ready.

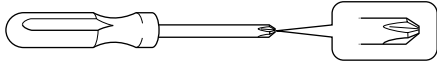

1. Remove the three backing papers from the adhesive tape in the case, and fit the floppy disk drive into the case.

Insert the drive to the case, with the side having the rubber stoppers facing the case.

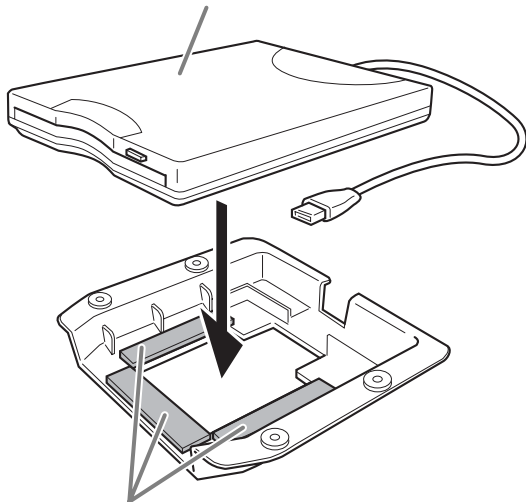

Dual-sided adhesive tape

2. Fold the USB cable inside the case as shown.

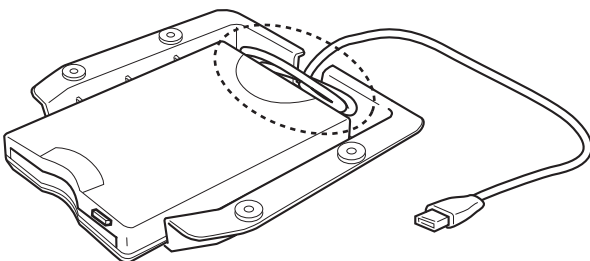

3. Attach the drive and case assembly to the left underside of the instrument, using the included four screws (4mm x 10mm).

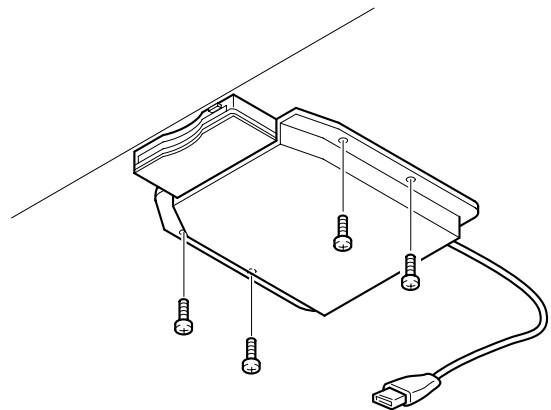

4. Connect the USB cable to the USB [TO DEVICE] terminal.

Specifications

Item	CLP-295GP
Keyboard	Natural Wood keyboard (real wood on white keys only)
Sound Source	AWM Dynamic Stereo Sampling
Polyphony (max)	128
Voice Selection	Panel preset for manual performance: 38 voices, XG voices: 480 voices + 12 drum kits, GM2 and GS voices for GM2/GS song playback
Effect	Reverb, Chorus, Brilliance, Variation effect, Insertion effect x 3, iAFC
Controls	Dual, Split
Display	LCD
Recording/Playback	16-track recording/playback, tempo adjustment
Memory Device	Optional USB storage device (via USB TO DEVICE terminal) Flash memory (internal): 1.7 MB
Pedal	Damper (with half-pedal effect), Sostenuto, Soft
Demo Songs	16 voice demo songs, 50 preset songs
Jacks/Terminals	MIDI (IN/OUT/THRU), PHONES x 2, AUX IN (L/L+R, R), AUX OUT (L, R), USB TO HOST, USB TO DEVICE, AUX PEDAL
Main Amplifiers	60W x 2 + 20W x 2
Speakers	16cm x 2, 5cm x 2, 3cm (DOME) x 2, 10cm x 2
Dimensions (W x D x H) (Lid up)	1,434 mm x 1,146 mm x 931 mm [56 1/2" x 45 1/8" x 36 2/3"] With music rest: (1,434 mm x 1,146 mm x 1,581 mm) [56 1/2" x 45 1/8" x 62 1/4"]
Weight	108kg [238 lbs., 2 oz]
Accessories	"50 greats for the Piano" Score Collection, Owner's Manual, Data List, Bench (included or optional depending on locale), Accessory CD-ROM for Windows, Accessory CD-ROM for Windows Installation Guide

* Specifications and descriptions in this owner's manual are for information purposes only. Yamaha Corp. reserves the right to change or modify products or specifications at any time without prior notice. Since specifications, equipment or options may not be the same in every locale, please check with your Yamaha dealer.

Index

You can search the desired section using not only the terminology in this manual but also commonly-used words. The * mark indicates that the corresponding page includes the terminology explanation in the right column.

Numerics

50 greats for the Piano	5
50 Piano Preset Songs	22
Practicing a one-hand part.....	24

A

A – D [-][+] buttons	12
A-B repeat.....	26
Accessories.....	5
Adding variation to the sound → Effect function.....	29
Application Index.....	8
Assembly.....	111
Assigning the SONG [PLAY/PAUSE] function to a pedal	89
AUX IN [L/L+R] [R] jacks	61
AUX OUT [L] [R] jacks.....	61
[AUX PEDAL] jack	60
Auxiliary pedal function	88

B

Backup	93, 94
Bench	5
BRILLIANCE [MELLOW]/[BRIGHT] buttons.....	29

C

Calibration.....	84
Center pedal.....	28
Center pedal function	87
CharacterCode.....	55
Characters.....	55
[CHORUS] button.....	30
combining two voices → Dual mode.....	31
Connection	
Audio.....	61
computer	65
Other Components.....	60
Speaker	61
USB [TO HOST]	65
[CONTRAST] knob.....	17
CONTRAST*	17
Copy.....	51
Current memory	45
Current song.....	45

D

Damper (right) pedal.....	28
Data Compatibility.....	106
Data type.....	59
Default (Normal) setting*	29
Delete	49

[DEMO] button	20
Demonstration tunes	20
Detailed Settings.....	68
Function	85
iAFC.....	83
Metronome	76
recording and playback	73
voices	77
display	12
Display contrast.....	17
DOC (Disk Orchestra Collection).....	107
DOWN (TEMPO)	
50 Piano Preset Songs	23
metronome.....	35

Driver	65
Dual	
Detailed settings.....	77
Recording.....	44
Dual mode → combining two voices.....	31

E

Effect function	29
equalizer	81
ESEQ	106
[EXIT] button.....	13
External song	45
[EXTRA PARTS] button.....	36, 41

F

FactorySet	93
Fast forward	23, 57
FILE*	45
[FILE/SONG SETTING] button	45, 73
Floppy Disk.....	114, 115
Floppy Disk Drive	115
Format.....	54
[FUNCTION] button	70, 85

G

GM System Level 1	106
GM System Level 2	106
GS.....	107

H

Headphones.....	17
hub	62

I

iAFC	
iAFC Detailed settings	83
[iAFC SETTING] button	69, 83

J

Jacks	
AUX IN.....	61
AUX OUT.....	61
AUX PEDAL.....	60
PHONES.....	17

K

key cover.....	14
KeyOffSampling.....	90

L

LCD → Screen	
Contrast	17
[LEFT] button.....	24, 36, 41
Left pedal.....	28
Left pedal function	87
Lid.....	15
List	
Demonstration tunes.....	20
Detailed Settings.....	68
Message.....	95
Preset Voice	108

M

M	46
MakeDir	54
[MASTER VOLUME] dial.....	17
MASTER VOLUME*	17
MEMORY	57
Memory.....	45
Memory song.....	45
MemoryBackup	93
Message List	95
METRONOME [ON/OFF] button	35
METRONOME [SETTING] button.....	68, 76
MIDI [IN][OUT][THRU] terminals	60
MIDI cables.....	66
Midi settings.....	70
MIDI terminals	66
Move.....	53
MP	46
MS.....	46
Ms	46
Music braces	14
Music Data	56
Music rest.....	14

N

New Song	36
Normal setting*	29

O

Other settings 85

P

P 46

Parameter List..... 68

Pedal Function

Auxiliary..... 88

Center..... 87

Left..... 87

Right 87

Pedals 28

Personal computer 65

[PHONES] jacks..... 17

PhraseMark..... 73

PLAY/PAUSE

50 Piano Preset Songs..... 22

Recorded Songs and Music Data 57

[PLAY/PAUSE] button 22, 57

Playback

50 Piano Preset Songs..... 22

Demo Songs 21

Recorded Songs and Music Data 57

Playing back repeatedly (song)..... 73

playing two voices → Split mode 33

[POWER] switch..... 16

Practicing a one-hand part (50 preset songs)
24

PRESET 57

50 Piano Preset Songs..... 22

Preset song memory..... 45

Preset Voice List 108

R

[REC] button..... 37

Recording

Tape Recorder..... 61

Recording in Dual 44

Recording in Split..... 44

Recording Your Performance..... 36

Rename 50

[REPEAT] button..... 25

Repeat Playback..... 25

Re-recording a song partially..... 39

[REVERB] button 30

Rewind 23, 57

[RIGHT] button..... 24, 36, 41

Right pedal..... 28

Right pedal function 87

RIGHT/LEFT

50 Piano Preset Songs..... 24

S

Save..... 48

Scale..... 86

Select

50 piano preset songs..... 22

Demo Songs 21

Recorded Songs and Music Data 56

[SELECT] switch 63

Selecting a touch response 85

SMF (Standard MIDI File) 106

Soft (left) pedal 28

Song

Data Type 59

Detailed settings..... 73

Playing back repeatedly 73

[SONG BALANCE] slider..... 44

SONG SELECT

Recorded Songs and Music Data 56

[SONG SELECT] button 22, 56

SongAutoOpen 55

Sostenuto (center) pedal 28

Sound

brilliance..... 29

expression..... 29

reverberation 30

spread and spaciousness 30

Soundboard reverb..... 30

Split

Detailed settings 77

Recording 44

[SPLIT] button 33

Split mode → playing two voices 33

Split point 34

Splitting the keyboard range and playing
two different voices 33

STOP

50 Piano Preset Songs..... 23

Recorded Songs and Music Data 58

[STOP] button..... 23, 58

Storage memory 45

StringResonance 90

SustainSampling..... 90

Sync Start

50 preset songs 24

Recorded Songs and Music Data 57

T

TEMPO

50 Piano Preset Songs..... 23

metronome..... 35

Recorded Songs and Music Data 58

TEMPO [UP] [DOWN] buttons..... 35

Terminals

MIDI [IN] [OUT] [THRU] 60, 66

USB [TO DEVICE] 60

USB [TO HOST] 60

TouchResponse..... 85

Transpose 85

Troubleshooting 104

Tune 86

Type of characters..... 55

Type of data (recorded)..... 101

U

U1 46

UIP 46

UIS 46

U1s..... 46

UP (TEMPO)

50 Piano Preset Songs 23

metronome 35

USB [TO DEVICE] terminal 60

USB [TO HOST] terminal..... 60

USB storage device 62

USB1 57

V

Voice group buttons..... 27, 33

[VOICE SETTING] button..... 69, 77

Voices* 27

Detailed settings 77

Volume

Balance (SONG BLANCE) 44

Setting 17

X

XG..... 106

IMPORTANT SAFETY INSTRUCTIONS

INFORMATION RELATING TO PERSONAL INJURY, ELECTRICAL SHOCK, AND FIRE HAZARD POSSIBILITIES HAS BEEN INCLUDED IN THIS LIST.

WARNING- When using any electrical or electronic product, basic precautions should always be followed. These precautions include, but are not limited to, the following:

- 1.** Read all Safety Instructions, Installation Instructions, Special Message Section items, and any Assembly Instructions found in this manual **BEFORE** making any connections, including connection to the main supply.
- 2.** Main Power Supply Verification: Yamaha products are manufactured specifically for the supply voltage in the area where they are to be sold. If you should move, or if any doubt exists about the supply voltage in your area, please contact your dealer for supply voltage verification and (if applicable) instructions. The required supply voltage is printed on the name plate. For name plate location, please refer to the graphic found in the Special Message Section of this manual.
- 3.** This product may be equipped with a polarized plug (one blade wider than the other). If you are unable to insert the plug into the outlet, turn the plug over and try again. If the problem persists, contact an electrician to have the obsolete outlet replaced. Do **NOT** defeat the safety purpose of the plug.
- 4.** Some electronic products utilize external power supplies or adapters. Do **NOT** connect this type of product to any power supply or adapter other than one described in the owners manual, on the name plate, or specifically recommended by Yamaha.
- 5.** **WARNING:** Do not place this product or any other objects on the power cord or place it in a position where anyone could walk on, trip over, or roll anything over power or connecting cords of any kind. The use of an extension cord is not recommended! If you must use an extension cord, the minimum wire size for a 25' cord (or less) is 18 AWG. **NOTE:** The smaller the AWG number, the larger the current handling capacity. For longer extension cords, consult a local electrician.
- 6.** Ventilation: Electronic products, unless specifically designed for enclosed installations, should be placed in locations that do not interfere with proper ventilation. If instructions for enclosed installations are not provided, it must be assumed that unobstructed ventilation is required.
- 7.** Temperature considerations: Electronic products should be installed in locations that do not significantly contribute to their operating temperature. Placement of this product close to heat sources such as; radiators, heat registers and other devices that produce heat should be avoided.
- 8.** This product was **NOT** designed for use in wet/damp locations and should not be used near water or exposed to rain. Examples of wet/damp locations are; near a swimming pool, spa, tub, sink, or wet basement.
- 9.** This product should be used only with the components supplied or; a cart, rack, or stand that is recommended by the manufacturer. If a cart, rack, or stand is used, please observe all safety markings and instructions that accompany the accessory product.
- 10.** The power supply cord (plug) should be disconnected from the outlet when electronic products are to be left unused for extended periods of time. Cords should also be disconnected when there is a high probability of lightning and/or electrical storm activity.
- 11.** Care should be taken that objects do not fall and liquids are not spilled into the enclosure through any openings that may exist.
- 12.** Electrical/electronic products should be serviced by a qualified service person when:
 - a. The power supply cord has been damaged; or
 - b. Objects have fallen, been inserted, or liquids have been spilled into the enclosure through openings; or
 - c. The product has been exposed to rain; or
 - d. The product does not operate, exhibits a marked change in performance; or
 - e. The product has been dropped, or the enclosure of the product has been damaged.
- 13.** Do not attempt to service this product beyond that described in the user-maintenance instructions. All other servicing should be referred to qualified service personnel.
- 14.** This product, either alone or in combination with an amplifier and headphones or speaker/s, may be capable of producing sound levels that could cause permanent hearing loss. **DO NOT** operate for a long period of time at a high volume level or at a level that is uncomfortable. If you experience any hearing loss or ringing in the ears, you should consult an audiologist. **IMPORTANT:** The louder the sound, the shorter the time period before damage occurs.
- 15.** Some Yamaha products may have benches and/or accessory mounting fixtures that are either supplied as a part of the product or as optional accessories. Some of these items are designed to be dealer assembled or installed. Please make sure that benches are stable and any optional fixtures (where applicable) are well secured **BEFORE** using. Benches supplied by Yamaha are designed for seating only. No other uses are recommended.

PLEASE KEEP THIS MANUAL

FCC INFORMATION (U.S.A.)

1. IMPORTANT NOTICE: DO NOT MODIFY THIS UNIT!

This product, when installed as indicated in the instructions contained in this manual, meets FCC requirements. Modifications not expressly approved by Yamaha may void your authority, granted by the FCC, to use the product.

2. **IMPORTANT:** When connecting this product to accessories and/or another product use only high quality shielded cables. Cable/s supplied with this product MUST be used. Follow all installation instructions. Failure to follow instructions could void your FCC authorization to use this product in the USA.
3. **NOTE:** This product has been tested and found to comply with the requirements listed in FCC Regulations, Part 15 for Class "B" digital devices. Compliance with these requirements provides a reasonable level of assurance that your use of this product in a residential environment will not result in harmful interference with other electronic devices. This equipment generates/uses radio frequencies and, if not installed and used according to the instructions found in the users manual, may cause interference harmful to the operation of

other electronic devices. Compliance with FCC regulations does not guarantee that interference will not occur in all installations. If this product is found to be the source of interference, which can be determined by turning the unit "OFF" and "ON", please try to eliminate the problem by using one of the following measures:

Relocate either this product or the device that is being affected by the interference.

Utilize power outlets that are on different branch (circuit breaker or fuse) circuits or install AC line filter/s.

In the case of radio or TV interference, relocate/reorient the antenna. If the antenna lead-in is 300 ohm ribbon lead, change the lead-in to co-axial type cable.

If these corrective measures do not produce satisfactory results, please contact the local retailer authorized to distribute this type of product. If you can not locate the appropriate retailer, please contact Yamaha Corporation of America, Electronic Service Division, 6600 Orangethorpe Ave, Buena Park, CA90620

The above statements apply ONLY to those products distributed by Yamaha Corporation of America or its subsidiaries.

* This applies only to products distributed by YAMAHA CORPORATION OF AMERICA.

(class B)

IMPORTANT NOTICE FOR THE UNITED KINGDOM

Connecting the Plug and Cord

IMPORTANT. The wires in this mains lead are coloured in accordance with the following code:

BLUE : NEUTRAL
BROWN : LIVE

As the colours of the wires in the mains lead of this apparatus may not correspond with the coloured markings identifying the terminals in your plug proceed as follows:

The wire which is coloured BLUE must be connected to the terminal which is marked with the letter N or coloured BLACK.

The wire which is coloured BROWN must be connected to the terminal which is marked with the letter L or coloured RED.

Making sure that neither core is connected to the earth terminal of the three pin plug.

(2 wires)

- This applies only to products distributed by Yamaha-Kemble Music (U.K.) Ltd.

COMPLIANCE INFORMATION STATEMENT (DECLARATION OF CONFORMITY PROCEDURE)

Responsible Party : Yamaha Corporation of America
Address : 6600 Orangethorpe Ave., Buena Park,
Calif. 90620
Telephone : 714-522-9011
Type of Equipment : Electronic Piano
Model Name : CLP-295GP

This device complies with Part 15 of the FCC Rules.

Operation is subject to the following conditions:

- 1) this device may not cause harmful interference, and
- 2) this device must accept any interference received including interference that may cause undesired operation.

See user manual instructions if interference to radio reception is suspected.

* This applies only to products distributed by
YAMAHA CORPORATION OF AMERICA.

(FCC DoC)

CAUTION: TO PREVENT ELECTRIC SHOCK, MATCH WIDE BLADE OF PLUG TO WIDE SLOT, FULLY INSERT.

ATTENTION: POUR ÉVITER LES CHOCS ÉLECTRIQUES, INTRODUIRE LA LAME LA PLUS LARGE DE LA FICHE DANS LA BORNE CORRESPONDANTE DE LA PRISE ET POUSSER JUSQU' AU FOND.

(polarity)

- This applies only to products distributed by Yamaha Canada Music Ltd.
- Ceci ne s'applique qu'aux produits distribués par Yamaha Canada Musique Ltée.

MEMO

MEMO

For details of products, please contact your nearest Yamaha representative or the authorized distributor listed below.

Pour plus de détails sur les produits, veuillez-vous adresser à Yamaha ou au distributeur le plus proche de vous figurant dans la liste suivante.

Die Einzelheiten zu Produkten sind bei Ihrer unten aufgeführten Niederlassung und bei Yamaha Vertragshändlern in den jeweiligen Bestimmungsländern erhältlich.

Para detalles sobre productos, contacte su tienda Yamaha más cercana o el distribuidor autorizado que se lista debajo.

NORTH AMERICA

CANADA

Yamaha Canada Music Ltd.
135 Milner Avenue, Scarborough, Ontario,
M1S 3R1, Canada
Tel: 416-298-1311

U.S.A.

Yamaha Corporation of America
6600 Orangethorpe Ave., Buena Park, Calif. 90620,
U.S.A.
Tel: 714-522-9011

CENTRAL & SOUTH AMERICA

MEXICO

Yamaha de México S.A. de C.V.
Calz. Javier Rojo Gómez #1149,
Col. Guadalupe del Moral
C.P. 09300, México, D.F., México
Tel: 55-5804-0600

BRAZIL

Yamaha Musical do Brasil Ltda.
Rua Joaquim Floriano, 913 - 4º andar, Itaim Bibi,
CEP 04534-013 Sao Paulo, SP. BRAZIL
Tel: 011-3704-1377

ARGENTINA

Yamaha Music Latin America, S.A.
Sucursal de Argentina
Viamonte 1145 Piso2-B 1053,
Buenos Aires, Argentina
Tel: 1-4371-7021

PANAMA AND OTHER LATIN AMERICAN COUNTRIES/ CARIBBEAN COUNTRIES

Yamaha Music Latin America, S.A.
Torre Banco General, Piso 7, Urbanización Marbella,
Calle 47 y Aquilino de la Guardia,
Ciudad de Panamá, Panamá
Tel: +507-269-5311

EUROPE

THE UNITED KINGDOM

Yamaha-Kemble Music (U.K.) Ltd.
Sherbourne Drive, Tilbrook, Milton Keynes,
MK7 8BL, England
Tel: 01908-366700

IRELAND

Danfay Ltd.
61D, Sallynoggin Road, Dun Laoghaire, Co. Dublin
Tel: 01-2859177

GERMANY

Yamaha Music Central Europe GmbH
Siemensstraße 22-34, 25462 Rellingen, Germany
Tel: 04101-3030

SWITZERLAND/LIECHTENSTEIN

**Yamaha Music Central Europe GmbH,
Branch Switzerland**
Seefeldstrasse 94, 8008 Zürich, Switzerland
Tel: 01-383 3990

AUSTRIA

**Yamaha Music Central Europe GmbH,
Branch Austria**
Schleiergasse 20, A-1100 Wien, Austria
Tel: 01-60203900

CZECH REPUBLIC/SLOVAKIA/ HUNGARY/SLOVENIA

**Yamaha Music Central Europe GmbH,
Branch Austria, CEE Department**
Schleiergasse 20, A-1100 Wien, Austria
Tel: 01-602039025

POLAND

**Yamaha Music Central Europe GmbH
Sp.z o.o. Oddział w Polsce**
ul. 17 Stycznia 56, PL-02-146 Warszawa, Poland
Tel: 022-868-07-57

THE NETHERLANDS/ BELGIUM/LUXEMBOURG

**Yamaha Music Central Europe GmbH,
Branch Benelux**
Clarissenhof 5-b, 4133 AB Vianen, The Netherlands
Tel: 0347-358 040

FRANCE

Yamaha Musique France
BP 70-77312 Marne-la-Vallée Cedex 2, France
Tel: 01-64-61-4000

ITALY

Yamaha Musica Italia S.P.A.
Viale Italia 88, 20020 Lainate (Milano), Italy
Tel: 02-935-771

SPAIN/PORTUGAL

Yamaha-Hazen Música, S.A.
Ctra. de la Corona km. 17, 200, 28230
Las Rozas (Madrid), Spain
Tel: 91-639-8888

GREECE

Philippos Nakas S.A. The Music House
147 Skiathou Street, 112-55 Athens, Greece
Tel: 01-228 2160

SWEDEN

Yamaha Scandinavia AB
J. A. Wettergrens Gata 1
Box 30053
S-400 43 Göteborg, Sweden
Tel: 031 89 34 00

DENMARK

YS Copenhagen Liaison Office
Generatorvej 6A
DK-2730 Herlev, Denmark
Tel: 44 92 49 00

FINLAND

F-Musiikki Oy
Kluuvikatu 6, P.O. Box 260,
SF-00101 Helsinki, Finland
Tel: 09 618511

NORWAY

Norsk filial av Yamaha Scandinavia AB
Grini Næringspark 1
N-1345 Østerås, Norway
Tel: 67 16 77 70

ICELAND

Skifan HF
Skeifan 17 P.O. Box 8120
IS-128 Reykjavik, Iceland
Tel: 525 5000

OTHER EUROPEAN COUNTRIES

Yamaha Music Central Europe GmbH
Siemensstraße 22-34, 25462 Rellingen, Germany
Tel: +49-4101-3030

AFRICA

**Yamaha Corporation,
Asia-Pacific Music Marketing Group**
Nakazawa-cho 10-1, Hamamatsu, Japan 430-8650
Tel: +81-53-460-2312

MIDDLE EAST

TURKEY/CYPRUS

Yamaha Music Central Europe GmbH
Siemensstraße 22-34, 25462 Rellingen, Germany
Tel: 04101-3030

OTHER COUNTRIES

Yamaha Music Gulf FZE
LB21-128 Jebel Ali Freezone
P.O.Box 17328, Dubai, U.A.E.
Tel: +971-4-881-5868

ASIA

THE PEOPLE'S REPUBLIC OF CHINA

Yamaha Music & Electronics (China) Co.,Ltd.
25/F., United Plaza, 1468 Nanjing Road (West),
Jingan, Shanghai, China
Tel: 021-6247-2211

HONG KONG

Tom Lee Music Co., Ltd.
11/F., Silvercord Tower 1, 30 Canton Road,
Tsimshatsui, Kowloon, Hong Kong
Tel: 2737-7688

INDONESIA

**PT. Yamaha Music Indonesia (Distributor)
PT. Nusantik**
Gedung Yamaha Music Center, Jalan Jend. Gatot
Subroto Kav. 4, Jakarta 12930, Indonesia
Tel: 21-520-2577

KOREA

Yamaha Music Korea Ltd.
Tong-Yang Securities Bldg. 16F 23-8 Yoido-dong,
Youngdungpo-ku, Seoul, Korea
Tel: 02-3770-0660

MALAYSIA

Yamaha Music Malaysia, Sdn., Bhd.
Lot 8, Jalan Perbandaran, 47301 Kelana Jaya,
Petaling Jaya, Selangor, Malaysia
Tel: 3-78030900

PHILIPPINES

Yupangco Music Corporation
339 Gil J. Puyat Avenue, P.O. Box 885 MCPO,
Makati, Metro Manila, Philippines
Tel: 819-7551

SINGAPORE

Yamaha Music Asia Pte., Ltd.
#03-11 A-Z Building
140 Paya Lebar Road, Singapore 409015
Tel: 747-4374

TAIWAN

Yamaha KHS Music Co., Ltd.
3F, #6, Sec.2, Nan Jing E. Rd. Taipei.
Taiwan 104, R.O.C.
Tel: 02-2511-8688

THAILAND

Siam Music Yamaha Co., Ltd.
891/1 Siam Motors Building, 15-16 floor
Rama 1 road, Wangmai, Pathumwan
Bangkok 10330, Thailand
Tel: 02-215-2626

OTHER ASIAN COUNTRIES

**Yamaha Corporation,
Asia-Pacific Music Marketing Group**
Nakazawa-cho 10-1, Hamamatsu, Japan 430-8650
Tel: +81-53-460-2317

OCEANIA

AUSTRALIA

Yamaha Music Australia Pty. Ltd.
Level 1, 99 Queensbridge Street, Southbank,
Victoria 3006, Australia
Tel: 3-9693-5111

NEW ZEALAND

Music Houses of N.Z. Ltd.
146/148 Captain Springs Road, Te Papapa,
Auckland, New Zealand
Tel: 9-634-0099

COUNTRIES AND TRUST TERRITORIES IN PACIFIC OCEAN

**Yamaha Corporation,
Asia-Pacific Music Marketing Group**
Nakazawa-cho 10-1, Hamamatsu, Japan 430-8650
Tel: +81-53-460-2312

HEAD OFFICE Yamaha Corporation, Pro Audio & Digital Musical Instrument Division
Nakazawa-cho 10-1, Hamamatsu, Japan 430-8650
Tel: +81-53-460-3273



Clavinova Web site (English only)

<http://www.yamahaclavinova.com/>

Yamaha Manual Library

<http://www.yamaha.co.jp/manual/>

U.R.G., Pro Audio & Digital Musical Instrument Division, Yamaha Corporation

© 2006 Yamaha Corporation

WH31750 607MWAP?.-01A0

Printed in Indonesia