

YAMAHA



DIGITAL RHYTHM PROGRAMMER

OWNER'S MANUAL

INTRODUCTION—HOW TO USE THIS MANUAL

Congratulations on your purchase of a Yamaha RX17 Digital Rhythm Programmer! Your RX17 has been developed through over a century of Yamaha research and design, and features advanced microcomputer control plus high-quality digital percussion sounds, virtually indistinguishable from live instruments. We suggest you read this manual carefully while operating the RX17. All operations, "Modes", "Functions" and "Jobs" are numbered for rapid reference. Also, all descriptions of actual operations are surrounded by a border, making them easy to locate. Here's a chapter-by-chapter guide to this manual.

CONTROL PANEL. Illustration of the RX17's control panel, to which you can refer at any time.

REAR PANEL/CONNECTIONS. Shows the functions of all connectors on the RX17's rear panel, and the type of equipment to which it can be connected.

PRECAUTIONS. It is highly recommended that you read this section. It will ensure that you are using your RX17 under optimum conditions.

BASIC OPERATIONS. This chapter shows how to set up your RX17 and play its "instruments", adjust their level, pan positions and accent levels, and set tempo.

PATTERN MODE. In the Pattern Mode you can write (record) and play rhythm patterns. Patterns are phrases or groups of drum beats which, when played, form a continuous rhythm accompaniment. You can also clear (erase) Patterns, copy Patterns, and check the remaining Pattern memory.

SONG MODE. A Song is a number of Patterns placed in sequence to form a rhythm accompaniment for a song or piece of music. You can clear (erase) Songs, copy Songs, and check the remaining Song memory. You can set the initial tempo of a Song, and also enter tempo changes, volume changes and repeats.

CASSETTE MODE. The RX17 lets you "save" all Patterns and Songs onto normal cassette tape, in the form of digital data. This data can be loaded (fed back into the RX17) at any time. You can also "Verify" that data has been correctly saved. In this way, you can save an unlimited number of Patterns and Songs onto cassette, and build up a library of rhythm data.

MIDI MODE. The RX17 is fully compatible with MIDI (Musical Instrument Digital Interface)—the technology that allows rhythm programmers, synthesizers and sequence recorders to control each other by means of simple cable connections. This Mode lets you select how the RX17 can control or be controlled by other MIDI equipment, or even by a "Tape Sync" signal recorded on tape.

HINTS AND TIPS. A chapter which you'll find useful once you're familiar with the operations of your RX17. This chapter provides you with performance notes and a variety of tips on how you can creatively use the full potential of your RX17. It will broaden your knowledge of the operations described in the MODE chapters.

ERROR MESSAGES. If you see an error message on the LCD (Liquid Crystal Display) of your RX17, refer to this chapter. You'll find out whether an operation has been executed incorrectly, or whether there is a technical malfunction.

The SPECIFICATIONS and BLOCK DIAGRAM are followed by the MIDI IMPLEMENTATION CHART, for musicians who need specific information about the MIDI technology utilized in the RX17. You can, however, fully operate the RX17 with little or no technical know-how.

The PATTERN CHART and SONG CHART enable you to keep an accurate written record of the rhythm programs you have created on your RX17. Photocopy these charts to provide enough for all your Patterns and Songs.

The QUICK GUIDE is a reference index which lets you easily locate any particular operation on the RX17—useful in those moments when you're in a hurry and can't remember where in this manual an operation is described.

And now—it's all up to you. Enjoy your Yamaha RX17 Digital Rhythm Programmer!

CONTENTS

INTRODUCTION—HOW TO USE THIS MANUAL	
CONTROL PANEL	1
REAR PANEL/CONNECTIONS	2
PRECAUTIONS	3
1.0 BASIC OPERATIONS	4
1.1 SETTING UP	4
1.2 PLAYING THE RX17'S INSTRUMENTS	4
1.3 INSTRUMENT CHANGE	4
1.4 LEVEL	5
1.5 ACCENTS	6
1.6 PAN	6
1.7 TEMPO	6
2.0 PATTERN MODE	7
2.1 SELECT PATTERN	7
2.2 REAL TIME WRITE	8
2.3 STEP WRITE	9
2.4 CLEAR PATTERN	11
2.5 CLEAR ALL PATTERNS	12
2.6 COPY PATTERN	12
2.7 SHOW REMAINING MEMORY	13
3.0 SONG MODE	14
3.1 SELECT SONG	14
3.2 EDIT SONG	15
3.3 CLEAR SONG	20
3.4 CLEAR ALL SONGS	21
3.5 COPY SONG	21
3.6 SHOW REMAINING MEMORY	22
4.0 CASSETTE MODE	23
4.1 SAVE	23
4.2 LOAD	24
4.3 VERIFY	24
5.0 MIDI MODE	25
5.1 SYNC	25
5.2 MIDI CHANNEL MESSAGE	25
5.3 SET RECEIVE CHANNEL	26
5.4 TRANSMIT CHANNEL ASSIGN	26
5.5 MIDI NOTE ASSIGN	26
5.6 RECEIVE BULK	27
5.7 TRANSMIT BULK	27
5.8 ECHO BACK	28
6.0 HINTS AND TIPS	29
6.1 THE INSTRUMENTS	29
6.2 PATTERN OPERATIONS	29
6.3 SONG OPERATIONS	30
6.4 CASSETTE OPERATIONS	30
6.5 MIDI OPERATIONS	30
ERROR MESSAGES	34
SPECIFICATIONS	35
BLOCK DIAGRAM	36
MIDI IMPLEMENTATION CHART	37
PATTERN CHART	38
SONG CHART	39
QUICK GUIDE	40

CONTROL PANEL

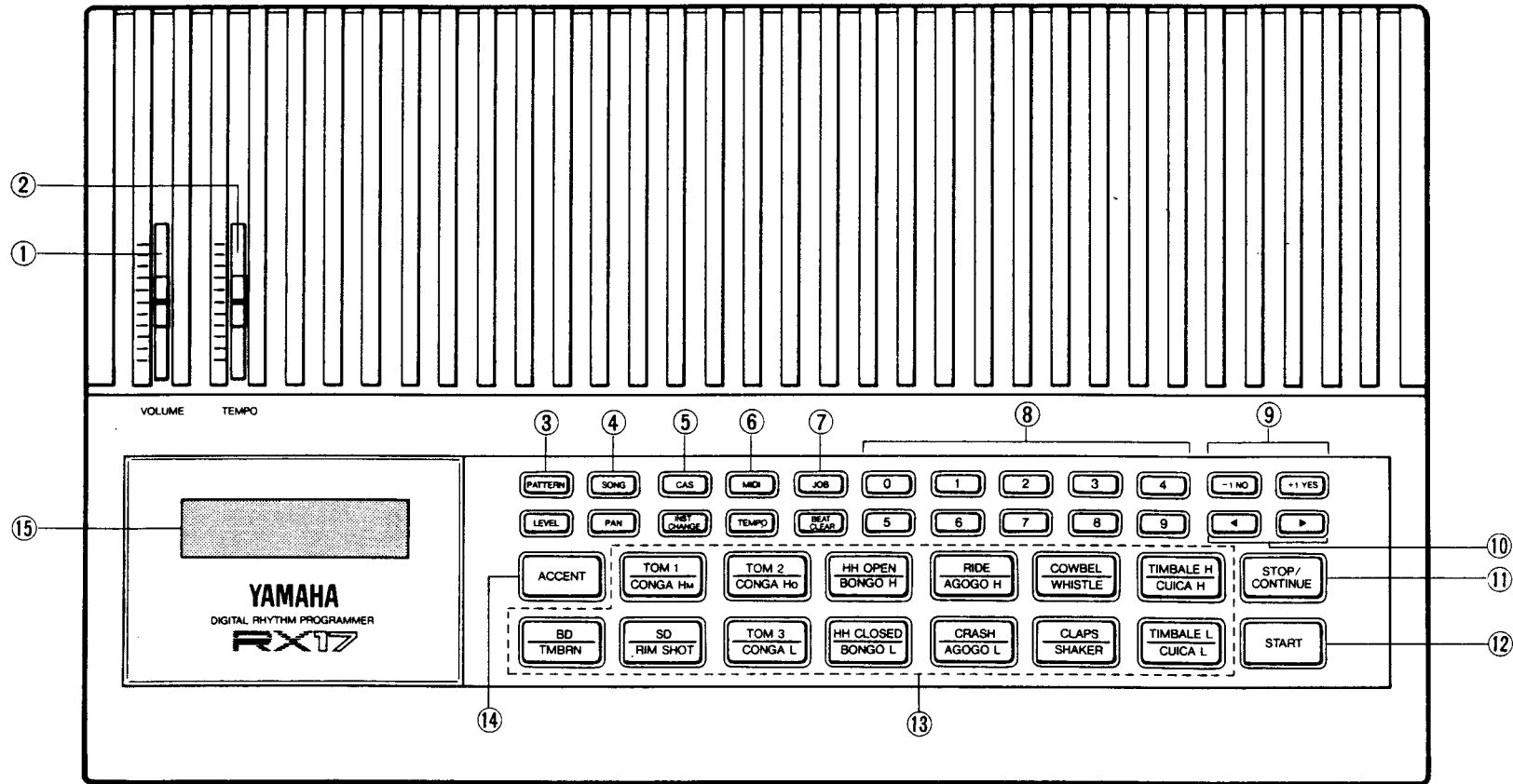

- | | | | |
|---|------------------------------|---|--|
| 1. MASTER VOLUME slider control. | 5. CASSETTE MODE key. | 9. -1/NO and +1/YES keys. | 13. INSTRUMENT keys. |
| 2. TEMPO slider control. | 6. MIDI MODE key. | 10. ◀ ▶ keys. | 14. ACCENT key. |
| 3. PATTERN MODE key. | 7. JOB key. | 11. STOP/CONTINUE key. | 15. LCD (Liquid Crystal Display). |
| 4. SONG MODE key. | 8. Numeric Key Pad . | 12. START key. | |

REAR PANEL/CONNECTIONS

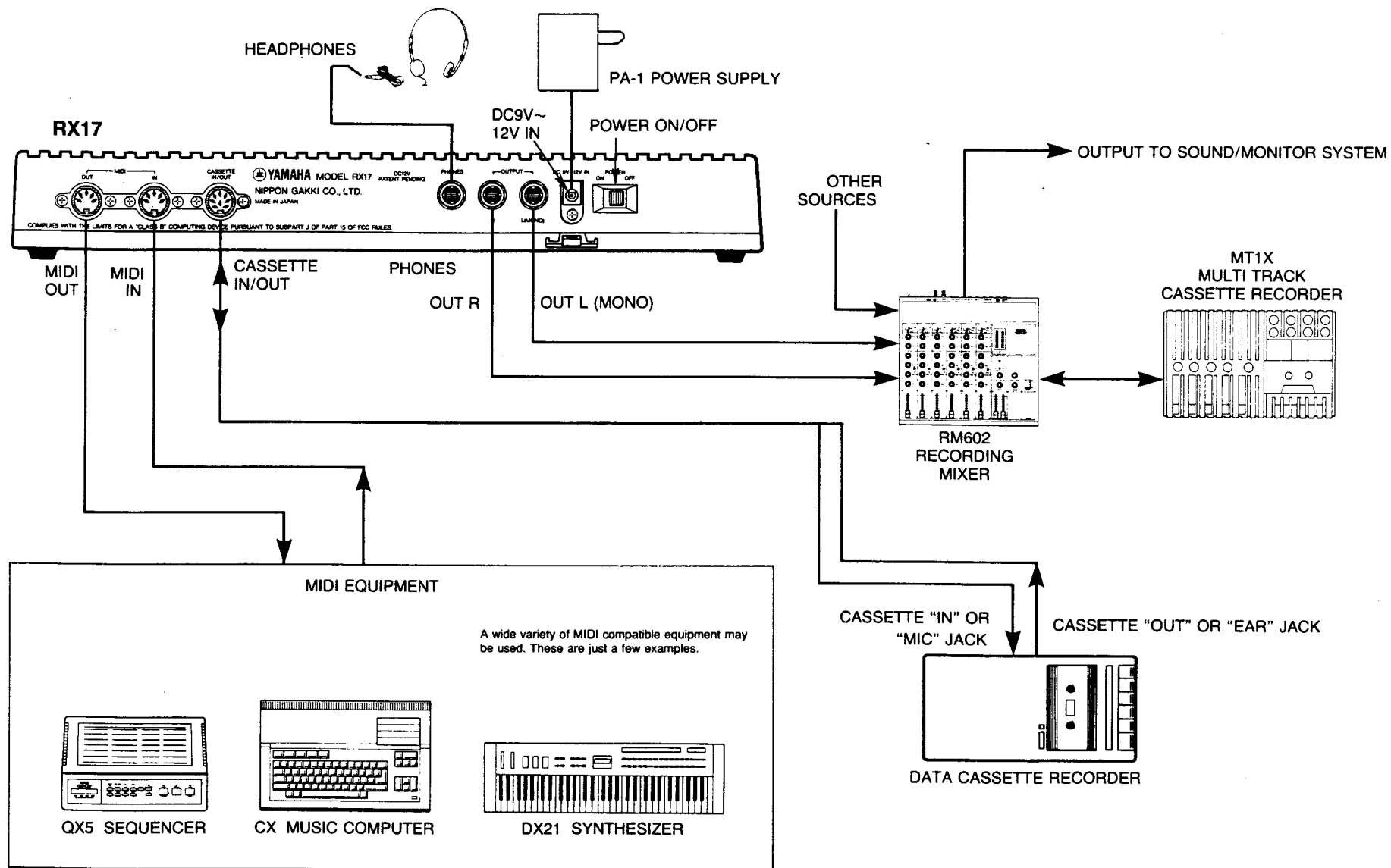

PRECAUTIONS

- Avoid placing the RX17 in locations exposed to direct sunlight or high temperatures, excessively high or low humidity, high dust concentration, or vibration.
- Be sure to connect the RX17 to an AC power supply that meets the power supply specifications listed on the accompanying PA-1 12-volt AC convertor.
- If there is any possibility of an electrical storm occurring nearby, remove the power plug from the wall socket in advance.
- Be sure to make all connections properly, as shown in the REAR PANEL/CONNECTIONS section.
- To avoid damaging your speakers and other playback equipment, turn off the power of all related equipment before making connections.
- Do not use excessive force in handling control switches and knobs.
- To avoid broken cords and short circuits, be sure to unplug all connectors by grasping the respective plugs—NOT the cords.
- Remove the power plug from the AC wall socket if the unit is not to be used for an extended period of time.
- Remove all plugs and connections if the unit is to be moved, to prevent damage to the cords and jacks.
- Do not use solvents such as benzene or paint thinner to clean the unit. Do not use insecticides or other pressurized spray products in proximity to the unit. Wipe off the exterior with a soft cloth.

EFFECTS ON OTHER ELECTRONIC EQUIPMENT

Since this unit incorporates digital circuitry, simultaneous use of other equipment such as TVs, radios, etc. in close proximity to the RX17 may cause noise and erroneous operation. If this occurs, move the RX17 away from the affected units to eliminate the problem. It is also a good idea to use separate line filters on each piece of equipment.

BACKUP BATTERY

The RX17 has a special lithium backup battery system to preserve data even when the power is turned off. This battery has a life of approximately 5 years. When the battery voltage is low, one of two special messages will appear on the RX17's LCD (see the ERROR MESSAGES chapter near the end of this manual). This means that you should have the battery replaced. Do not attempt to replace the battery yourself. Refer this job to your Yamaha dealer.

NOTE: When the battery is replaced, all Pattern and Song data in the RX17 will be lost. Be sure to save this data to tape or floppy disk before having the battery replaced.

1.0 BASIC OPERATIONS

1.1 SETTING UP

1. Connect the PA-1 AC convertor to the RX17 first, then to the AC power supply.
2. To hear the RX17, do one of the following:
 - A. Connect stereo headphones to the PHONES connector.
 - B. Connect the L(MONO) output to an amplifier, for mono playback.
 - C. Connect the R and L(MONO) outputs to a stereo amplifier or mixer, for stereo playback.
3. Turn the RX17 power ON.

NOTE: A brief output pulse appears at the RX17 outputs when the power is initially turned on. To prevent this from possibly damaging your speaker system, make sure the master volume control of your amplifier or mixer is set to minimum before the RX17 is turned ON. Better yet, turn the RX17 on first, then your sound system.

- MIDI and cassette connections will be described later, in the appropriate chapters.

1.2 PLAYING THE RX17 INSTRUMENTS

The RX17 instruments can be played by tapping on the black instrument keys. While playing, adjust the MASTER VOLUME slider until you can hear the RX17's instruments at a comfortable listening level. The sounds you will hear will normally correspond to the instrument names written on the UPPER part of the instrument keys. You can easily change instruments on the RX17, as described in the next section.

1.3 INSTRUMENT CHANGE

Each key on the RX17 features 2 instrument sounds. These are listed in the following chart. The RX17 has a total of 26 highly realistic voices, providing powerful drum sounds plus exciting Latin percussion sounds.

INSTRUMENT CHART

UPPER SET		LOWER SET	
BD	Bass Drum	TMBRN	Tambourine
SD	Snare Drum	RIM SHOT	Snare Drum rim shot
TOM1	High Tom-tom	CONGA Hm	High Conga (muted)
TOM2	Medium Tom-tom	CONGA Ho	High Conga (open)
TOM3	Low Tom-tom	CONGA L	Low Conga
HH OPEN	Hi-hat (open)	BONGO H	High Bongo
HH CLOSED	Hi-hat (closed)	BONGO L	Low Bongo
RIDE	Ride cymbal	AGOGO H	High Agogo
CRASH	Crash cymbal	AGOGO L	Low Agogo
COWBEL	Cowbell	WHISTLE	Whistle
CLAPS	Claps	SHAKER	Shaker
TIMBALE H	High Timbale	CUICA H	High Cuica
TIMBALE L	Low Timbale	CUICA L	Low Cuica

You can change all instruments, or individual instruments, between the UPPER and LOWER instruments.

NOTE 1: Instrument Change operations can be carried out at any time except during a cassette operation or MIDI Bulk Dump (operations 5.6 and 5.7).

NOTE 2: The Instrument Change operation will NOT change instruments already programmed in a Pattern or Song.

The following pairs of instruments can NOT be played together, because they reproduce the sound of two different ways of playing the same instrument.

CONGA Hm / CONGA Ho
 CUICA H / CUICA L
 SD / RIM SHOT
 HH OPEN / HH CLOSED

This also applies when writing Patterns. For example, if in the Step Write mode you enter a SD note, then enter a RIM SHOT note on the same beat, the SD note will be erased.

1.3.1 ALL INSTRUMENT CHANGE

1. Press **INST CHANGE**

```
> INST CHANGE
upper or lower ?
```

2. Use the ◀ or ▶ key to select UPPER or LOWER. The flashing cursor will move to the selected set.
3. Press **+1 YES** to make the change. The LCD will briefly show

```
COMPLETE !
upper or lower ?
```

then return to the display shown before pressing **INST CHANGE**.

1.3.2 SINGLE INSTRUMENT CHANGE

1. Press **INST CHANGE**

```
> INST CHANGE
upper or lower ?
```

2. Press the key corresponding to the instrument you wish to change.

```
> INST CHANGE
BD selected
```

3. Press the same instrument key again to change the instrument.

```
> INST CHANGE
Tambn selected
```

4. Press **INST CHANGE** again to return to the mode the RX17 was in before the Instrument Change operation.

1.4 LEVEL

The **MASTER VOLUME** slider controls the overall level of the RX17. There are, however, three other level operations possible.

- **CLICK LEVEL** lets you change the level of the click signal that you will hear as a timing guide when writing a Pattern in Real Time.
- **INSTRUMENT LEVEL** lets you change the level of individual instruments.
- **ACCENT LEVEL** lets you change the Accent level of individual instruments (refer to section 1.5 for an explanation of Accents).

NOTE 1: These operations can be carried out at any time except during a cassette operation or MIDI Bulk (operations 5.6 and 5.7).

NOTE 2: The **-1 NO** and **+1 YES** keys are used for level change, as well as many other operations. Pressing and releasing these keys causes a change of one unit. Holding them down causes a rapid and continuous change.

1.4.1 CLICK LEVEL

1. Press **LEVEL**

```
> INST LEVEL
Click 20
```

2. Use the **-1 NO** key to reduce the Click level, or the **+1 YES** key to increase the Click level. RANGE: 0 (OFF)—31.
3. Press **LEVEL** again to return to the mode the RX17 was in before the Click Level operation.

1.4.2 INSTRUMENT LEVEL

1. Press **LEVEL**

```
> INST LEVEL
Click 20
```

2. Press the instrument key corresponding to the instrument whose level you wish to change.

```
> INST LEVEL
BD 31
```

3. Use the **-1 NO** or **+1 YES** key to change the Instrument level. RANGE: 0 (OFF)—31.
4. Press **LEVEL** again to return to the mode the RX17 was in before the Instrument Level operation.

1.4.3 ACCENT LEVEL

1. Press **LEVEL**

```
> INST LEVEL
Click 20
```

- Press and hold the green **ACCENT** key and then press the instrument key corresponding to the instrument whose Accent level you wish to change.

```
> INST LEVEL
BD      (Ac) +10!
```

- Use the **-1 NO** or **+1 YES** key to change the Accent level. RANGE: ± 31 .
- Press **LEVEL** again to return to the mode the RX17 was in before the Accent Level operation.

NOTE: If you have set a plus Accent level and an exclamation mark appears on the LCD (as in the above example) it means that the combined Accent level plus Instrument level is above 31 (the maximum possible Instrument Level). In this case, the Accent will not have as much effect as you intended. For example, if the level of a voice is 24, the maximum possible Accent level is 31 minus 24 = 7, so an Accent level of, say +10 is impossible.

If you have set a minus Accent level and the exclamation mark appears, it means that the combined Accent Level plus Instrument level is zero or less, and the voice will not sound when accented.

1.5 ACCENTS

Pressing any instrument key while holding the green **ACCENT** key causes that instrument to sound at its accented level. This applies whether the RX17 is being played in real time, or programmed in either the Real Time Write or Step Write Modes. Accents allow you to add natural dynamics to your drum patterns. You can even enter negative Accent values, which will reduce the level of the instrument. See 1.4.3 ACCENT LEVEL.

1.6 PAN

If you are using both the RX17's stereo outputs, you will find that the instruments are heard at different positions in the stereo sound image. You can easily alter the stereo position of individual instruments.

NOTE 1: This operation can be carried out at any time except during a cassette operation or MIDI Bulk (operations 5.6 and 5.7).

NOTE 2: 15 Pan positions are possible, from Left to Right. These correspond to positions 1/15 thru 15/1 on an RX15 Digital Rhythm programmer.

1.6.1 INSTRUMENT PAN

- Press **PAN**

```
> PAN
select INST
```

- Press the instrument key corresponding to the instrument that is to have its Pan position set. On the LCD the cursor will flash at the current pan position.

```
> PAN      BD
L-----●-----R
```

- Use the **-1 NO** or **+1 YES** key to change the Pan position. The cursor will move to the new position.
- Press **PAN** again to return to the mode the RX17 was in before the Pan operation.

1.7 TEMPO

The playback and writing speed of Patterns and the playback speed of Songs can be varied at any time by moving the TEMPO slider. You can also display the Tempo on the LCD, for precise Tempo setting.

NOTE: This operation can be carried out at any time except during a cassette operation, during Initial Tempo setting (operation 3.2.7) or during MIDI Bulk (operations 5.6 and 5.7).

1.7.1 TEMPO

- Press **TEMPO**

```
> TEMPO
J = 118
```

- Use the **-1 NO** or **+1 YES** key, or the **TEMPO** slider, to change the Tempo. RANGE: 40—250 quarter-notes per minute.

NOTE: The **TEMPO** slider allows you to change the tempo in increments of 3 units in the range 40—166, and in increments of 4 units in the range 166—250. The **-1 NO** and **+1 YES** keys should be used for exact tempo setting.

- Press **TEMPO** again to return to the mode the RX17 was in before the Tempo operation.

2.0 PATTERN MODE

On the RX17, a "Pattern" means a one bar sequence, which repeats when you play it back. You "write" (enter) each note of a Pattern, by pressing the instrument keys. Pattern Writing can be done in two ways: Real Time (see 2.2) or Step Write (see 2.3). The Quantize feature allows you to set the "fineness" of Pattern Writing, i.e., the shortest notes that may be written (see 6.2.2. and 6.2.3 for a full explanation of Quantize). The RX17 lets you create up to 100 Patterns, numbered 00 thru 99.

2.0.1 ENTERING THE PATTERN MODE

When you turn on the RX17, the Patterns Mode's first Function (Select Pattern) is automatically selected. Once you have selected a Pattern, you can play it, or use other Functions to edit its Accent Levels, or to copy, clear (erase) or write on it (to enter additional notes). If you've selected an empty Pattern, you can then begin writing a new Pattern.

If the RX17 is in another Mode, press **PATTERN** to enter the Pattern Mode. The LCD will show

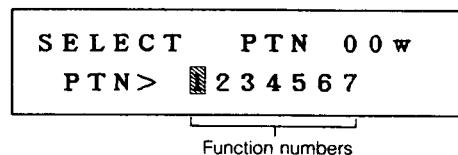

The Function numbers (1 thru 7) allow you to select the Pattern Mode's seven main Functions. This is done by using the ◀ or ▶ keys to move the cursor to the appropriate Function number. The LCD will then display the selected function. You can also move the cursor by holding **JOB** and pressing the Numeric Key corresponding to the Function number. If you press only **JOB**, the cursor will move to Function 1. To exit the Pattern Mode, press any other Mode key.

Pattern Mode Functions are numbered 2.1 thru 2.7 in this chapter.

2.1 SELECT PATTERN

1. Press **PATTERN** The flashing cursor will indicate Function 1.

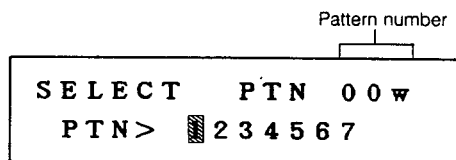

You will see a "w" in the right upper corner of the LCD if the Pattern already contains data ("w" stands for "written"). This makes it easy for you to select an empty Pattern, should you wish to write a new Pattern.

In the Pattern Select Mode, there are two methods of selecting Patterns.

- **-1 NO and +1 YES keys**

This is a convenient way of selecting an adjacent or nearby Pattern.

Pressing the **-1/NO** key selects the Pattern number immediately BELOW the current Pattern number.

Pressing the **+1/YES** key selects the Pattern number immediately ABOVE the current Pattern number.

Each of these keys when held down causes a continuous and rapid Pattern number change.

- **NUMERIC KEY PAD**

This is a more convenient way of selecting a Pattern in a distant number range.

Use the Numeric Key Pad to enter a two-digit Pattern number. Pattern numbers below 10 must be preceded by a zero. For example, for Pattern 5, enter "0" then "5".

NOTE: The RX17 contains a variety of factory-preset Patterns in Pattern locations 50 thru 99. We suggest that you listen to all of them — you will find many of them immediately usable, while others can be edited to create your own Patterns. These Patterns are listed and fully described in the accompanying RX17 PATTERN BOOK. See 2.1.2 LOADING THE PRESET PATTERNS for a description of how to recall the preset Patterns.

2.1.1 PATTERN PLAY

The Pattern Play function will repeatedly play the selected Pattern until you stop play.

1. After selecting a Pattern, press **START**

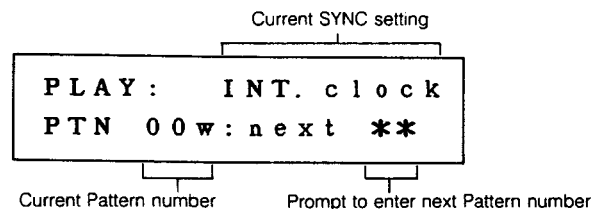

New Patterns can be selected during play, using either of the two methods described in 2.1 SELECT PATTERN (except that holding down the **-1 NO** and **+1 YES** keys will NOT produce continuous Pattern number change. The asterisks will be replaced by the new Pattern number, and the newly selected Pattern will begin playing immediately after the last beat of the previous Pattern.

2.0 PATTERN MODE

2. To stop play, press **STOP/CONTINUE**.

Indicates play has stopped

```

STOP :   INT. clock
PTN 00w : next **
  
```

3. To restart play, press **START** to play from the beginning of the Pattern, or **STOP/CONTINUE** to play from the point at which play was stopped.
- During Pattern play, you can change the Tempo using the **TEMPO** slider, or using operation 1.7.1.

2.1.2 LOADING THE PRESET PATTERNS

NOTE: This operation also loads the RX17's preset Songs into Song locations 0—3.

The preset Patterns in Pattern locations 50—99 are there to be played, edited, copied or cleared as you wish. However, they are permanently stored in the RX17, and can be re-loaded into the Pattern locations at any time.

BEFORE turning the RX17's power on, hold down the **ACCENT** key. Keep holding this key while turning the power on.

The display will ask if you are loading preset patterns. Press **YES**. The display will ask if you are sure. Press **YES** again.

The preset Patterns will now be loaded into Pattern locations 50—99.

NOTE: All previous data in Patterns 0—99 will be erased. If this data is important, save it to tape (operation 4.1) BEFORE executing the Load Preset Patterns operation.

2.1.3 USING THE PATTERN CHART

Near the end of this manual you will find a Pattern Chart. You can copy this chart and use the copies to keep an absolutely accurate written record of Patterns that you have created on your RX17. This chart accommodates the data of a 4/4 Pattern written at the maximum Quantize setting of 1/48. Longer Patterns may be recorded by using two Pattern Charts. Enter data as follows:

- Enter Note Markers (solid dots) at the intersections of the lines.
- Indicate accented notes using a circle.
- If you have used the Accent Edit function to alter the Accent Level of any notes, write the new Accent Level next to the Note Markers for those notes.
- Enter the Level, Accent Level and Quantize setting of each instrument.
- Enter the Pan setting of each instrument, using a number from 1—15. 1 means Left; 15 means Right; 8 means Center. Other positions are numbered corresponding to the mark at which the cursor is set on the LCD Pan display.

2.2 REAL TIME WRITE

This is the first of two ways of writing Patterns on the RX17. It lets you "play" a Pattern on the instrument keys, while listening to a click guide. You can add instruments and rhythms until the Pattern is complete. The advantage of this method is that you can actually hear the Pattern being built up as you write it, as opposed to Step Write, where a Pattern is built up without hearing it.

NOTE: You can also execute Real Time writing of Patterns using an external MIDI keyboard to "play" the RX17's instruments. This is highly convenient because all 26 RX17 instruments can be assigned to a keyboard (compared to using the RX17's instrument keys, with a maximum of 13 instruments available at any one time). Another advantage is that the RX17 will accept MIDI Key Velocity data, so that the harder you play a key on your MIDI synthesizer, the louder the RX17's note will be. See 6.5.3 MIDI NOTE RECEIVE for an explanation of the settings required for this MIDI application.

2.2.1 ENTERING REAL TIME WRITE

1. After selecting a Pattern, select Function 2.

```

REAL WRITE  00 ?
PTN> 1 █ 3 4 5 6 7
  
```

2. Press **+1 YES** to enter Real Time Write. The LCD will show the Pattern LENGTH display.

NOTE: If you decide you do NOT want to enter Real Time Write, press **PATTERN** to return to Select Pattern.

2.2.2 SETTING PATTERN LENGTH

Providing you have selected an empty Pattern, you can now set the time signature (length) of your Pattern. Pattern Lengths are displayed in 16th notes. For example, 16/16 (the default Pattern Length displayed when you call an empty Pattern) is equivalent to a bar of 4/4 time (4 quarter-notes per bar); 12/16 indicates a bar of 3/4 time, and so on.

Time signature

```

LENGTH = 16 / 16
RT. W> █ 2
  
```

Use the **-1 NO** and **+1 YES** keys to set the time signature. RANGE: 1/16—32/16.

2.2.3 SETTING QUANTIZE

Quantize when used in Real Time Write is an automatic timing correction device. Any notes you play that do not fall exactly on the beat are moved to the nearest beat. For example, if you set Quantize to 1/16, all notes played will be moved to the nearest 16th note. This is a convenient way of creating timing-perfect Patterns. Quantize is set as follows:

1. After setting the Pattern Length, press **▶** to move the cursor to "2".

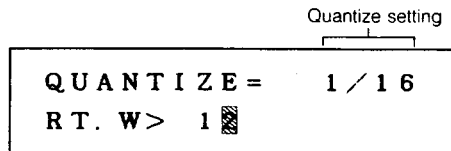

2. Use the **-1 NO** and **+1 YES** keys to set the Quantize. You can step forwards or backwards through the range of Quantize settings: 1/8, 1/16, 1/32, 1/12, 1/24, 1/48.

NOTE: You can call the Quantize function while writing a Pattern (see 2.2.4 ENTERING NOTES) as follows.

1. Press **STOP/CONTINUE**
2. Select Job 2. Set the Quantize using the **+1 YES** or **-1 NO** keys.
3. Press **START** to return to Real Time Write and continue entering notes.

2.2.4 ENTERING NOTES

1. Once the Pattern Length and Quantize have been set, press **START** to commence writing. You'll hear a Click track (a rhythm guide) indicating quarter-notes, with an Accent on the first beat of each bar.

RECORD : INT. c l o c k

PTN 00

2. You can now enter notes by tapping the instrument keys. As soon as you enter the first note, a "w" will appear next to the Pattern number on the LCD, indicating that data has been "written" into the Pattern. You can enter accented notes by holding the green **ACCENT** key while you tap an instrument key. The RX17 will continue cycling through the Pattern, repeating everything that you have entered. You can add more notes until the Pattern is complete.
3. Once you've written a Pattern, press **STOP**. The LCD will return to the Pattern Length or Quantize display (according to which of these two operations was the last one executed prior to Pattern writing). This enables you to change the Quantize setting (see operation 2.2.3) if desired. You could then continue writing the Pattern by pressing **START** again.

4. If you want to play the Pattern, press **PATTERN** after pressing **STOP/CONTINUE**. The LCD will return to the Select Pattern display. You can now play your Pattern by pressing **START**. You can then, if you wish, re-enter Real Time Write, to add or delete notes in the Pattern.

2.2.5 DELETING NOTES

During Pattern writing, a note can be deleted (cleared) by holding the **BEAT CLEAR** key, and tapping the appropriate instrument key when you hear the selected note. The next time the Pattern recycles, you will not hear the selected note.

2.2.6 DELETING INSTRUMENTS

Entire instrument parts can be deleted (erased) from a Pattern, by entering Step Write and using operation 2.3.7.

2.2.7 ACCENT EDIT

After writing a Pattern, you can alter the level of any note in the Pattern, by entering Step Write and using operation 2.3.8.

2.3 STEP WRITE

This is the second way to write Patterns on the RX17. It lets you create a Pattern, using the instrument keys to enter notes one at a time, until the Pattern is complete. This is an ideal way for creating perfectly-timed Patterns, especially if reading from a score. It also allows you to create Patterns that are too complex or fast to be played in Real Time.

- During Step Write, the notes you enter are clearly shown on the LCD in the form of a Dot Display, described in 2.3.4 ENTERING NOTES.

2.3.1 ENTERING STEP WRITE

1. After selecting a Pattern, select Function 3.

STEP WRITE 00 ?

PTN > 12 4567

2. Press **+1 YES** to enter Step Write. The LCD will show the Pattern LENGTH display.

NOTE 1: If you decide you do NOT want to enter Step Write, press **PATTERN** to return to Select Pattern.

NOTE 2: If you selected a Pattern that already contains data, step 2 of this operation will call up the Step Write Dot Display, described in 2.3.4 ENTERING NOTES.

2.3.2 SETTING PATTERN LENGTH

See operation 2.2.2.

2.3.3 SETTING QUANTIZE

In the Step Write mode, Quantize allows you to set the minimum note length that can be entered. For example, if you set Quantize to 1/16, the shortest note that can be entered is a 16th note (16 notes in a bar of 4/4). Quantize is set as follows:

1. After setting the Pattern Length, press ► to move the cursor to "2".

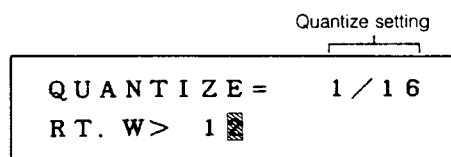

2. Use the **-1 NO** and **+1 YES** keys to set the Quantize. You can step forwards or backwards through the range of Quantize settings: 1/08, 1/16, 1/32, 1/12, 1/24, 1/48.

NOTE: You can call the Quantize function from the Dot Display (see 2.3.4 ENTERING NOTES) as follows.

1. Press **JOB**.
2. Set Quantize as previously described.
3. Press **START** to return to the Dot Display and continue entering notes.

2.3.4 ENTERING NOTES

1. Once the Pattern Length and Quantize have been set, press **START** to commence writing. The LCD will show the Dot Display. The initial Dot Display will be the one corresponding to Hi Hat Closed.

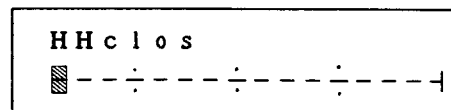

This display shows 4 quarter-notes to the bar, indicated by the vertical pairs of small dots. The Quantize indicates 16 beats to the bar, each beat indicated by a horizontal dash. The flashing cursor prompts you to input a note or rest on the first beat of bar

1. You can now choose either of the following options (2A or 2B):

- 2A. Enter a note by tapping the **HH CLOSED** key. An accented note can be entered by holding down the green **ACCENT** key while pressing **HH CLOSED**. The note will be shown in the form of a Note Marker. The cursor will move to the next beat.

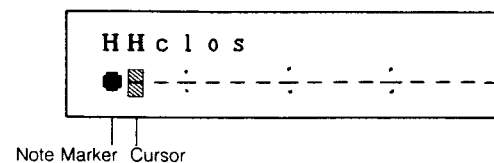

- 2B. You can move the cursor to the next beat by pressing **+1 YES**. This also enters a rest in the Pattern.

In either case the beat will advance one count, and you can enter the next Hi-Hat Closed note. This process continues up to the last beat of the Pattern. When you reach the last beat, further pressings of **HH CLOSED** or **+1 YES** will not move the cursor, but will cause an "> End <" message to flash on the LCD.

- If you have entered a note on the last beat, the LCD will show the Accent Level of that note (this will be zero if you did not enter an accent). This allows you to edit (change) the Accent Level, and hence the level of this note. See 2.3.8 ACCENT EDIT.
3. To select another instrument at any time, press the appropriate instrument key. That instrument's Dot Display will appear, with the cursor at the same position as the previous Dot Display. No note will be entered until the second time you press the instrument key. You can enter the second instrument's part, then select another instrument simply by pressing its key, and build up your Pattern. Notes from up to 11 instruments can be entered on the same beat.
 4. Once you've written a Pattern, press **STOP/CONTINUE**. The LCD will return to the Select Pattern display. You can now play your Pattern by pressing **START**. You can then, if you wish, re-enter Step Write, to add or delete notes in the Pattern.

2.3.5 STEPPING THROUGH A PATTERN

During Step Write, you can step through a Pattern forwards or backwards by using **+1 YES** or **-1 NO** respectively. As you pass each beat you will hear the instrument(s) entered at that beat. You can also step through rapidly by holding down either key.

When you reach the end of a Pattern, an "> End <" message will flash on the LCD.

When you return to the beginning of a Pattern, a "> Top <" message will flash on the LCD.

NOTE: The **-1 NO** key does NOT enter any data. It is ONLY for stepping backwards through the Pattern.

2.3.6 DELETING NOTES

Notes can be deleted (erased) by stepping through a Dot Display until you locate the erroneous note, then holding the **BEAT CLEAR** key, and tapping the appropriate instrument key. The Note Marker will disappear, and the cursor will move to the next beat.

2.3.7 DELETING INSTRUMENTS

Entire instrument parts can be deleted (erased) from a Pattern, as follows.

- From a Dot Display, press **JOB**. Then use **▶** to move the cursor to "3", to select Function 3.

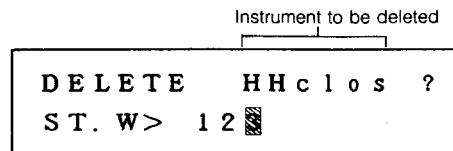

- Press the instrument key corresponding to the instrument you wish to delete. Its name will appear on the LCD.
- Press **+1 YES** to continue this operation. (Or press **START** to return to the Dot Display, if you do NOT wish to delete the instrument).

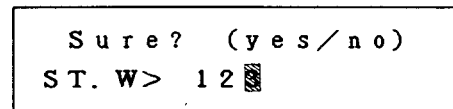

- Press **+1 YES** to delete the selected instrument. The LCD will return to the (now empty) Dot Display of the selected instrument. (Or press **-1 NO** to cancel this operation, and return the LCD to the previous display).

2.3.8 ACCENT EDIT

When you step through a Pattern (see operation 2.3) ,a message such "Ac=+08" appears on the LCD whenever the cursor reaches a Note Marker.

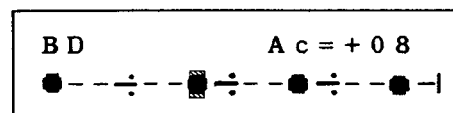

Cursor over Note Marker

This indicates that the note was recorded with an Accent Level of +8. An Accent level of 00 indicates that no Accent was used.

You can edit (alter) the Accent Level of the note at which the cursor is flashing. This in effect allows you alter the level of each note, to add expressive dynamics to your Patterns.

Hold down **ACCENT** and use **+1 YES** or **-1 NO** to raise or lower the Accent Level respectively. RANGE: ± 31 . See 1.5 ACCENTS for a note about Accent Level limits.

2.3.9 DOT DISPLAYS FOR LONG PATTERNS

The Dot Display only accomodates 16 beats. Your Pattern may have more beats than this, depending on its Length, and on the Quantize setting. For example a 6/4 bar (Length: 24/16) with a Quantize setting of 1/24 will contain 36 beats.

In this case, when the cursor reaches the limit of the displayed portion of the Dot Display (going in either direction) the Dot Display will start to "scroll" (move across the LCD) so that succeeding portions of the Dot Display will appear, one beat at a time.

2.3.10 DOT DISPLAYS: THE "X" MARKER

When "X" Markers appear on a Dot Display, they indicate notes that were entered at a different Quantize setting than the current Quantize setting. In other words, these notes fall "in between" the beats on the Dot Display.

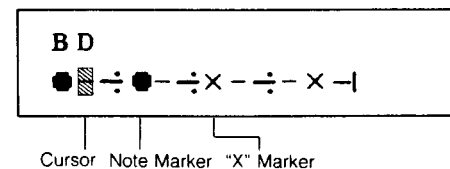

The Accent Level of these notes will NOT be displayed, and can NOT be edited. If you wish to edit Accent Levels, change the Quantize setting (see 2.3.3 SETTING QUANTIZE) to the setting at which the notes were entered.

2.4 CLEAR PATTERN

You can instantly clear (erase) a whole Pattern. This would be done, for example, if the RX17's Pattern memory were full and you wanted to write another Pattern.

- After selecting the Pattern you wish to clear, select Function 4.

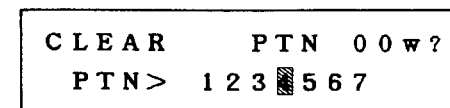

2. Press **+1 YES** to continue this operation. (Or press **PATTERN** to return to the Select Pattern display, if you do NOT wish to clear the Pattern).

```
Sure? (yes/no)
PTN> 123 5 67
```

3. Press **+1 YES** to clear the selected Pattern (or press **-1 NO** to cancel this operation). The LCD will show

```
COMPLETE !
PTN> 1234567
```

then return to the Select Pattern display.

2.5 CLEAR ALL PATTERNS

You can instantly clear (erase) all 100 Patterns. This would be done, for example, if the RX17's Pattern memory were full and you wanted to write more Patterns. Use operation 4.1 to save the Patterns on tape before this operation, if you wish to preserve the Patterns for later use. You can also save Patterns via MIDI, by using a MIDI data storage device such as the Yamaha MDF-1 MIDI Data Filer (see operation 5.7).

1. Press **PATTERN** and select Function 5.

```
CLEAR ALL PTNs ?
PTN> 1234 6 7
```

2. Press **+1 YES** to continue this operation (or press **PATTERN** to return to the Select Pattern display, if you do NOT wish to clear all Patterns).

```
Sure? (yes/no)
PTN> 1234 6 7
```

3. Press **+1 YES** to clear all Patterns (or press **-1 NO** to cancel this operation and return to the Select Pattern display). The LCD will show

```
COMPLETE !
PTN> 1234567
```

then return to the Select Pattern display.

2.6 COPY PATTERN

The Pattern Copy function lets you copy any selected Pattern to another destination in the RX17's Pattern memory. This is useful if you want to copy a Pattern in order to alter it to create a new Pattern, while retaining the original Pattern. It is also useful if you want to have the Patterns in a particular order in the RX17's memory (so that, for example, you can easily play one Pattern followed by the adjacent Pattern, by pressing **+1 YES** during play).

1. After selecting the Pattern you wish to copy, select Function 6.

```
COPY PTN11 →** ?
PTN> 12345 7
```

2. Use the Numeric Key Pad to enter the number of the Pattern destination to which the selected Pattern will be copied.

```
COPY PTN11 →36 ?
PTN> 12345 7
```

3. Press **+1 YES**.

```
Sure? (yes/no)
PTN> 12345 7
```

You can now cancel this operation by pressing **-1 NO**, if you do NOT wish to copy to the selected destination (if, for example, it already contains data). The LCD will return to the Select Pattern display.

4. To copy the Pattern, press **+1 YES**. The LCD will show

```
COMPLETE !  
PTN> 1 2 3 4 5 6 7
```

then return to the Select Pattern display.

2.7 SHOW REMAINING MEMORY

This function allows you to check the remaining Pattern memory of the RX17, as a percentage of its total Pattern memory capacity.

Press **PATTERN** and select Function 7.

```
REMAINING    070%  
PTN> 1 2 3 4 5 6 7
```

3.0 SONG MODE

The function of the Song Mode is to allow you to connect different Patterns in order to form a drum sequence for an entire song or piece of music. The RX17 lets you create up to 10 Songs, numbered 0 thru 9. Each Song can contain up to 999 Parts, and the maximum number of Parts of all 10 Songs combined is 1200. A Part can contain not only a Pattern, but also a Repeat Command, a Tempo Change or a Volume Change.

3.0.1 ENTERING THE SONG MODE

All Song operations are preceded by pressing **SONG** to enter the Song Mode. The LCD will show

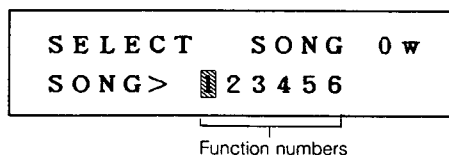

The Function numbers (1 thru 6) allow you to select the Song Mode's six main Functions. This is done by using the ◀ or ▶ keys to move the cursor to the appropriate Function number. The LCD will then display the selected function. You can also move the cursor by holding **JOB** and pressing the Numeric Key corresponding to the Function number. If you press only **JOB**, the cursor will move to Function 1.

To exit the Song Mode, press any other Mode key.

Song Mode Functions are numbered 3.1 thru 3.6 in this chapter.

3.1 SELECT SONG

1. Press **SONG**. The flashing cursor will indicate Function 1.

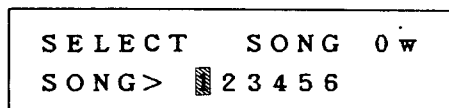

You will see a "w" in the right upper corner of the LCD if the Song already contains data ("w" stands for "written"). This makes it easy for you to select an empty Song, when you wish to write a new Song.

In the Song Select Mode, there are two methods of selecting Songs.

- **-1 NO and +1 YES keys**

Pressing the **-1 NO** key selects the Song number immediately BELOW the current Song number.

Pressing the **+1 YES** key selects the Song number immediately ABOVE the current Song number.

- **NUMERIC KEY PAD**

Use the Numeric Key Pad to enter a Song number.

NOTE: The RX17 contains a variety of factory-programmed Songs in Song locations 0 thru 3. We suggest that you listen to all of them — they will give you a good idea of the flexibility and musical power of the RX17. You may find these Songs to be immediately usable, or you can edit them to create your own Songs. These Songs are listed and fully described in the accompanying RX17 PATTERN/SONG BOOK. See 2.1.2 LOADING THE PRESET PATTERNS for a description of how to recall the preset Songs.

3.1.1 SONG PLAY

1. After selecting a Song, press **START**

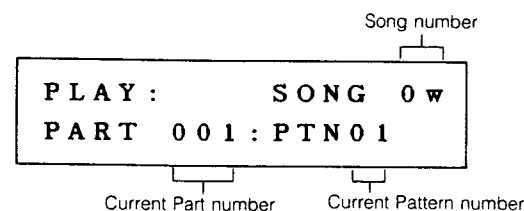

As the Song plays, Part numbers and Pattern numbers will be displayed. If a Part contains anything other than a Pattern (i.e., a Volume Change, Tempo Change or Repeat) it will not be displayed.

2. To stop play, press **STOP/CONTINUE**

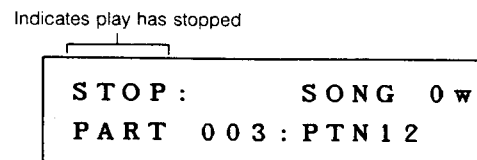

3. To restart play, press **START** to play from the beginning of the Song, or **STOP/CONTINUE**, to play from the point at which play was stopped. If you stopped play during a repeat section, the repeat command will be ignored when you continue play. If you stopped play in the middle of a Pattern, pressing **-1 NO** or **+1 YES** before pressing the **STOP/CONTINUE** key will cause play to restart from the beginning of the previous Pattern, or the beginning of the next Pattern, respectively. You can also use the **-1 NO** and **+1 YES** keys to locate any Part in the Song from which playback can restart.

- While a Song is stopped, you can use the Numeric keys to select another Song, without having to press the **SONG** key. The LCD will return to the Song Select display.
- During Song play, you can change the Tempo using the **TEMPO** slider, or using operation 1.7.1.

3.1.2 USING THE SONG CHART

Near the end of this manual you will find a Song Chart. You can copy this chart and use the copies to keep an absolutely accurate written record of Songs that you have created on your RX17. This chart accommodates the data of a Song containing 128 Parts. Longer Songs may be recorded by using two or more Song Charts. Enter data as follows:

- Enter Pattern numbers in the "PTN" column.
- If a Part contains data other than a Pattern, write this information in the "Other Data" column as follows:
 Enter the amount of Volume Changes.
 Enter the amount and duration of Tempo Changes.
 Enter Begin Repeat Signs.
 Enter End Repeat signs and the number of Repeats.

3.2 EDIT SONG

The Edit Song function lets you connect Patterns to form a Song. You can also enter Volume Changes, Tempo Changes and Repeats. Each of these data is entered into a Part. Songs can contain up to 999 Parts.

Briefly, Song editing is done as follows:

1. Enter Song Edit.
2. Enter data in the first Part. Then use the **+1 YES** key to move to the next Part, and enter data there. Continue in this way until the Song is complete.
3. Once you have entered all the Parts of your Song, press **STOP/CONTINUE** to exit the Edit Song Mode. You can now play your Song, by pressing **START**.

Here are some important pointers about the Edit Song Function:

- You can move backwards through a Song using the **-1 NO** key. This lets you go back to check a Part. Any time a Part is displayed, you can change its data using the Numeric Key Pad.

- Holding down a **-1 NO** or **+1 YES** key lets you move rapidly through a Song, backwards or forwards respectively.
- You can delete, copy or insert Parts in a Song that has already been edited. You can set the Initial Tempo of a Song, to automatically play it at the correct Tempo. And you can use the Search Part operation to automatically locate a selected Part in a Song. These operations are selected by entering Song Edit, pressing **JOB** then selecting a Job number using the **◀** and **▶** keys. You can also select Jobs by holding down **JOB** and pressing the appropriate Numeric Key. Job numbers are as follows:

JOB 1	SET INITIAL TEMPO
JOB 2	SEARCH PART
JOB 3	COPY PART
JOB 4	DELETE PART
JOB 5	INSERT PART

The Initial Tempo display appears when you press **JOB**

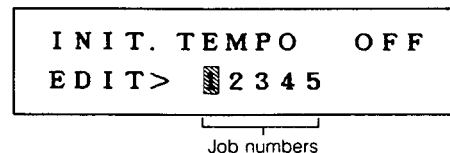

If, prior to pressing **JOB**, you had located the empty Part at the end of the Song, only Job numbers 1 thru 3 would be displayed, as Jobs 4 and 5 would not be needed (there's no data to delete, and no need to insert a Part — you can enter data in the normal way).

- At any time, once you're in Edit Song, you can return to the Song Select display simply by pressing **STOP/CONTINUE**, and play your Song or select other functions.
- It's a good idea to keep a written record of a Song, as you edit it. See the SONG CHART later in this manual.

3.2.1 ENTERING EDIT SONG

1. After selecting a Song, select Function 2.

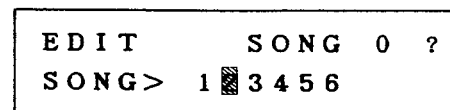

2. Press **+1 YES** to enter Edit Song.

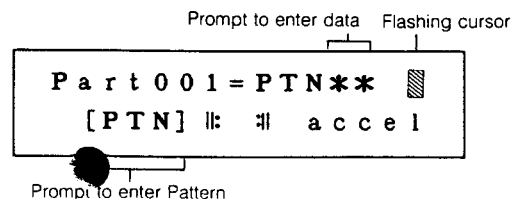

The LCD shows the first Part of the Song. The asterisks indicate that the Part is empty. The flashing cursor indicates that you can enter data. The flashing "PTN" indicates that the type of data you can enter is a Pattern number.

NOTE 1: There are square brackets around "PTN", as a further reminder that you can now enter a Pattern. By moving these brackets, you can enter other types of data. Move the brackets by pressing ►. The following types of data will be successively bracketed:

||: (Begin Repeat)
 :|| (End Repeat)
 accel (Accelerando, or Tempo increase)

The LCD will then switch to display the following symbols, which will be successively bracketed, as you press ►.

rit (Ritardando, or Tempo decrease)
 vol+ (Volume increase)
 vol- (Volume decrease)

These are the six types of data that can be entered in Song Edit. Before entering the actual data in an empty Part, you can use the ◀ and ▶ keys to move the brackets to the data you want. You can then use the Numeric Key Pad to enter the data value.

NOTE 2: If, after step 1 of this operation, you decide you do NOT want to enter Edit Song, press **SONG** or **STOP/CONTINUE** to return to Select Song.

NOTE 3: If you selected a Song that already contains data, the LCD will show the data contained in Part 001. You can enter new data in this Part, provided it's the same type of data (Pattern, Repeat, etc.). If you want to enter a different type of data, you'll need to delete the Part (operation 3.2.9) and insert a new Part (operation 3.2.10). For now (and for operations 3.2.2 thru 3.2.5) we'll assume that you've selected an empty Song.

3.2.2 ENTERING PATTERNS

- After selecting an empty Song and entering Edit Song, you can immediately enter a Pattern number in Part 001, using the Numeric Keys.

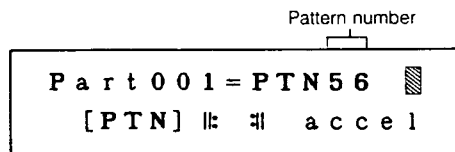

- Press +1 **YES** to move to the next Part, and enter data there.

3.2.3 ENTERING REPEATS

Repeats can save a lot of editing time, by making it possible to repeat any Part or group of Parts up to 99 times. This can be used, for example, when the same rhythm plays through an entire verse.

Repeats are entered in two operations. The Begin repeat command is entered at the start of the section which is to be repeated. Then the End Repeat is entered at the end of the section to be repeated, together with a number indicating the number of times that the section is to be repeated. Remember that the number of repeats should be ONE LESS than the total number of plays of the selected section. Each repeat command counts as a Part.

In this example, Parts 3 and 4 are repeated twice, making a total of three plays of those Parts.

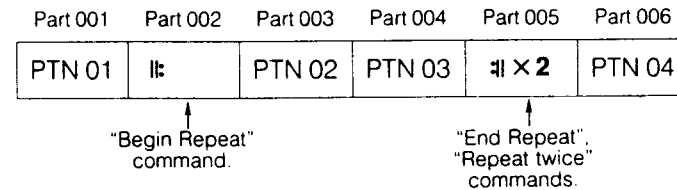

ACTUAL PLAYING SEQUENCE

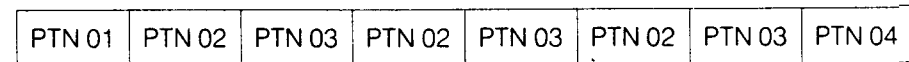

You can enter any number of repeats in a Song. You can also "nest" repeat commands, so that a short repeat section can occur within a larger repeat section. This would be done, for example, if a whole verse were to be repeated (repeat commands at start and end of the verse) AND a short section within the verse were to be repeated (repeat commands at start and end of short section in the verse). You can actually enter up to 48 "nests" of repeats, one inside another.

- After selecting a Song and entering Edit Song, press ► to move the brackets to the ||: symbol (this is standard musical notation for a Begin Repeat sign). The repeat sign will also appear in the upper part of the LCD.

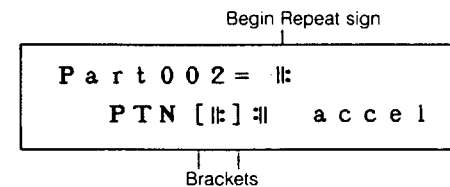

- Press **+1 YES** to enter a begin Repeat command. The LCD will automatically move to the next Part. Continue editing (entering Patterns and other data) and when you reach the point at which an End repeat command is needed (for example, Part 5) use the **▶** key to select **:||**, the symbol for an End repeat command.

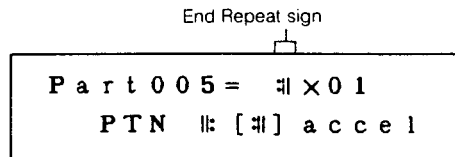

The LCD will display "01"—the default number of repeats. If only one repeat is needed, you can now press **+1 YES** to continue editing the Song.

- To enter a different number of repeats, use the Numeric Key Pad, entering a two-digit number (for example, 02). Range: 01—99.

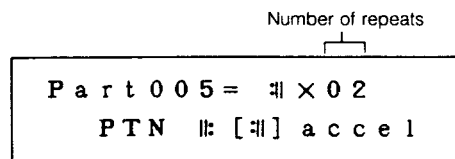

You can now continue editing by pressing **+1 YES**, or press **SONG** or **STOP/CONTINUE** to exit Edit Song.

- Repeats are often entered AFTER all the Pattern numbers have been entered for a Song. See 3.2.10 INSERT PART for how to insert data into a Song. Remember that a Repeat will create a new Part, and move all subsequent Parts forward.

3.2.4 ENTERING TEMPO CHANGES

This function allows you to enter a gradual change of tempo in a Song. The tempo can increase (accelerando) or decrease (ritardando). You can set the overall range of the Tempo Change, and the duration of the change. If you set the duration at zero, an instant Tempo Change will occur.

As the operation is virtually identical for both types of Tempo Change, we'll describe Accelerando only. The only difference is that you move the brackets to either "accel" or "rit", and the Tempo Change value is shown as a positive or a negative number respectively.

NOTE: When you play a Song that contains a Tempo Change, the final tempo of the Song will be different from the initial tempo. If you have not set an Initial Tempo for a Song, and you immediately play the Song again, it will begin playback at the new tempo. Therefore, it is recommended that you always set the Initial tempo for a Song. See 3.2.6 INITIAL TEMPO.

- After selecting a Song and entering Edit Song, press **▶** to move the brackets to "accel".

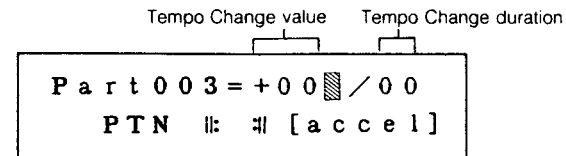

- The cursor will be flashing at the Tempo Change value. Use the Numeric Key Pad to set this value. RANGE: 0—99 quarter-notes/minute.

NOTE: The Tempo Change function can NOT alter the tempo beyond the RX17's tempo range (40—250 quarter-notes/minute).

- Press **+1 YES** to move the cursor to the Tempo Change duration position, and use the Numeric Key Pad to enter the Tempo Change duration. Range: 0—99 quarter—notes.

You can use the **-1 NO** and **+1 YES** keys to move the cursor back and forth, to reset the two Tempo Change parameters, as needed.

- The Tempo Change is now set, and you can press **+1 YES** to move on to the next Part and continue editing, or press **SONG** or **STOP/CONTINUE** to exit Edit Song.

- Tempo Changes are often entered AFTER all the Pattern numbers have been entered for a Song. See 3.2.10 INSERT PART for how to insert data into a Song. Remember that a Tempo Change will create a new Part, and move all subsequent Parts forward.

3.2.5 ENTERING VOLUME CHANGES

This function allows you to enter a change of volume in a Song. The volume can increase or decrease, and you can set the range of the Volume Change.

As the operation is virtually identical for both types of Volume Change, we'll describe a "vol+" (crescendo) operation only. The only difference is that you move the brackets to either "vol+" or "vol—" and the Volume Change value is shown as a positive number or a negative number respectively.

- After selecting a Song and entering Edit Song, press **▶** to move the brackets to "vol+".

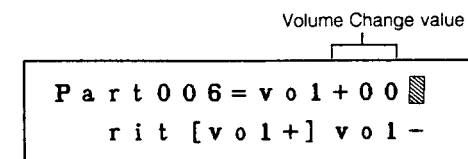

- The cursor will be flashing at the Volume Change value. Use the Numeric Key Pad to set this value. RANGE: 0—31.

NOTE: The Volume Change function can NOT alter the volume of any note beyond the RX17's Instrument Level range (0-31).

- The Volume Change is now set, and you can press **+1 YES** to move on to the next Part and continue editing, or press **SONG** or **STOP/CONTINUE** to exit Edit Song.

- Volume Changes are often entered AFTER all the Pattern numbers have been entered for a Song. See 3.2.10 INSERT PART for how to insert data into a Song. Remember that a Volume Change will create a new Part, and move all subsequent parts forward.

3.2.6 JOB 1: INITIAL TEMPO

This function lets you set the exact playback tempo for a Song that you have already edited. This lets you avoid the need for manually changing tempos between playback of Songs. Of course, any Tempo Change commands you have included in the Song will function (within the limits of the RX17's tempo range) and you can also vary the Tempo manually at any time.

- After selecting a Song and entering Edit Song, press **JOB**.

```
INIT. TEMPO  OFF
EDIT> █ 2 3 4 5
```

- You can now use the **-1 NO** and **+1 YES** keys to turn the Initial Tempo function Off or On respectively.
- To set the Initial Tempo value, press **TEMPO**.

```
INIT. TEMPO  ♩ = ***
EDIT> █ 2 3 4 5
```

- Asterisks indicate that the Initial Tempo has not yet been set. If it has been set, the setting will appear on the LCD. Use the **-1 NO** and **+1 YES** keys, or the **TEMPO** slider, to set the Initial Tempo.
- Press **START** to return to Edit Song (if you wish to continue editing the Song) or press **SONG** or **STOP/CONTINUE** to exit Edit Song.

3.2.7 JOB 2: SEARCH PART

This function lets you instantly locate any Part in a Song. This is useful and time-saving as it allows you to locate any point in the Song for editing (this can be compared to tape transport memory devices in recording studios, which allow you to "punch in" at a preselected point in a recording).

- After selecting a Song and entering Edit Song, press **JOB**.

```
INIT. TEMPO  OFF
EDIT> █ 2 3 4 5
```

- Use the **▶** key (or hold **JOB** and press **2**) to move the cursor to "2".

```
SEARCH Part*** ?
EDIT> 1 █ 3 4 5
```

- Use the Numeric Key Pad to enter a three-digit Part number (RANGE: 001—999). Then press **+1 YES**. The LCD will immediately show the selected Part, and the Pattern or other data contained there. Example: Part 006; Pattern 23.

```
Part 006 = PTN 23 w
[PTN] ||: || accel
```

You can now continue editing from this point.

3.2.8 JOB 3: COPY PART

This function lets you choose a Part or group of Parts, and copy them to another location in a Song, or to the end of the Song. This saves time if you have programmed the Parts for a verse, and want to repeat the same verse later in a Song. You can copy the entire verse in one operation, instead of having to copy each individual Part.

For example, suppose in this short 5-Part Song, you want to copy Parts 2 and 3 onto the end of the Song.

BEFORE COPYING

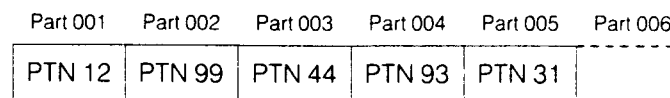

Part to be copied.

Copy destination

AFTER COPYING

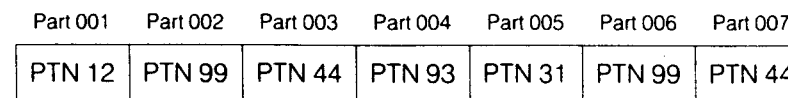

New Parts

You can also copy to a destination BEFORE the end of the Song, provided it comes BEFORE or AFTER the Parts which are to be copied. This example shows what happens if we copy Parts 2 and 3 to Part 4.

BEFORE COPYING

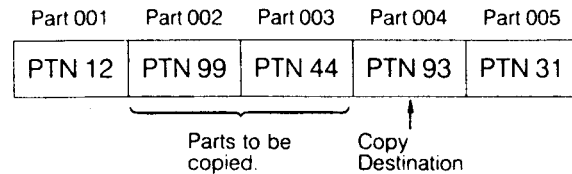

AFTER COPYING

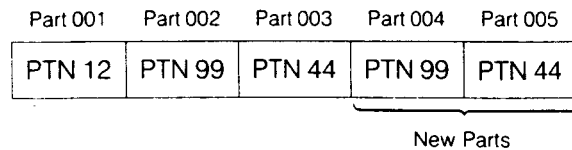

- After selecting a Song and entering Edit Song, press **JOB**, then select Job 3.

```
COPY → Part 001 ?
EDIT> 12 █ 45
```

You can now, if you wish, cancel this operation and return to the Edit Song display by pressing **START**.

- Use the Numeric Key Pad to select the number of the Part which will be the copy destination point, then press **+1 YES**.

```
from ***-*** ?
EDIT> 12 █ 45
```

- The two sets of three asterisks on the LCD prompt you to enter the Part numbers of the beginning and end of the section you wish to copy. If the section is only one Part, enter the same number twice. Use the Numeric Key Pad to enter three-digit Part numbers (RANGE: 001—999). In our example, we'll enter "002" then "003".

```
from 002-003 ?
EDIT> 12 █ 45
```

If you have entered wrong Part numbers, press **-1 NO** to clear the display, and enter the correct numbers.

- Press **+1 YES** to carry out the Copy Part operation (or press **START** to cancel this operation and return to the Edit Song display). The LCD will show "COMPLETE!" then display the last Part of the newly copied section. You can now continue editing or press **STOP** to exit Edit Song.

3.2.9 JOB 4: DELETE PART

The Delete Function lets you remove any Part from a Song that has already been edited. For example, if you want to remove Part 3 in our short Song, you would locate Part 3 and carry out the Delete Function.

BEFORE DELETING

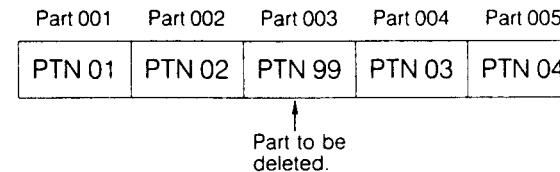

AFTER DELETING

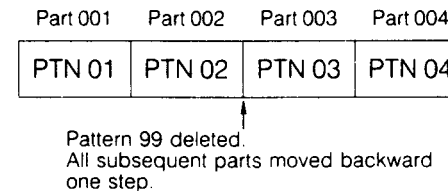

- You can also delete Parts containing Repeats, Tempo Changes and Volume Changes, in exactly the same way.

- After selecting a Song and entering Edit Song, press **JOB**, then select Job 4.

```
DELETE Part 003 ?
EDIT> 123 █ 5
```

You can now, if you wish, cancel this operation and return to the Edit Song display by pressing **START**.

- Use the Numeric Key Pad to select the number of the Part you wish to delete, then press **+1 YES**.

```
Sure? (yes/no)
EDIT> 123 █ 5
```

You now have another chance to cancel this operation, by pressing **-1 NO**. The LCD will return to the previous display, allowing you to select another Job.

3. To carry out the Delete operation, press **+1 YES** again. The LCD will show

```

COMPLETE !
EDIT> 1 2 3 4 5
  
```

then return to the Delete display, allowing you to select another Job.

4. If you wish to continue editing, press **START**. The LCD will show the Part FOLLOWING the Part that was deleted. In our example, this will be Part 003, containing Pattern 03.

```

Part 003 = PTN 03 w
[PTN] |: :| accel
  
```

3.2.10 JOB 5: INSERT PART

The Insert Function does the opposite of the Delete Function—it lets you select any point in a Song that has already been assembled, and insert new Parts between the already-programmed Parts. For example, if you want to insert a Part between Parts 2 and 3 of a Song, this means that you have to insert a new Part 3.

BEFORE INSERTING

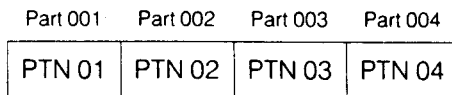

↑
Insert point
for new pattern
E.g., Pattern 99

AFTER INSERTING

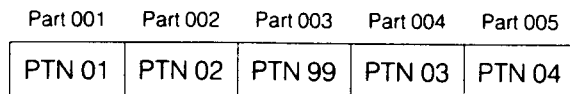

↑
Pattern 99 inserted into Part 3.
All subsequent parts moved forward
one step.

- You can also insert Repeats, Tempo Changes and Volume Changes.

1. After selecting a Song and entering Edit Song, press **JOB**, then select Job 5.

```

INSERT Part 001 ?
EDIT> 1 2 3 4
  
```

You can now, if you wish, cancel this operation and return to the Edit Song display, by pressing **START**.

2. Use the Numeric Key Pad to select the number of the Part you wish to insert, then press **+1 YES**. For example, Part 003.

```

Part 003 = PTN**
[PTN] |: :| accel
  
```

3. You can now enter any data in the new Part 003, in the normal way by moving the brackets to the desired type of data, and entering the data value. For example, Pattern 99.

```

Part 003 = PTN 99 w
[PTN]          accel
  
```

4. The new Part is now entered. You can now continue editing or press **SONG** or **STOP/CONTINUE** to exit Edit Song.

3.3 CLEAR SONG

You can instantly clear (erase) a whole Song. This would be done, for example, if the RX17's Song memory were full and you wanted to write another Song.

1. After selecting the Song you wish to clear, select Function 3.

```

CLEAR   SONG 0 w ?
SONG> 1 2 4 5 6
  
```

At this point, you can press **SONG** to return to the Select Song display, if you do NOT wish to clear the Song.

2. Press **+1 YES** to continue this operation.

```

Sure? (yes/no)
SONG> 12 4 5 6

```

You now have a second chance to cancel this operation, and return to the Select Song display by pressing **-1 NO**.

3. Press **+1 YES** to clear the selected Song. The LCD will show

```

COMPLETE !
SONG> 1 2 3 4 5 6

```

then return to the Select Song display.

3.4 CLEAR ALL SONGS

You can instantly clear (erase) all 10 Songs. This would be done, for example, if the RX17's Song memory were full and you wanted to write more Songs. Use operation 4.1 to save the Songs on tape before clearing all Songs, if you wish to preserve the Songs for later use. You can also save Songs via MIDI, by using a MIDI data storage device such as the Yamaha MDF-1 MIDI Data Filer (see operation 5.7).

1. Press **SONG** and select Function 4.

```

CLEAR ALL SONGs ?
SONG> 1 2 3 5 6

```

At this point, you can press **SONG** to return to the Select Song display, if you do NOT wish to clear all Songs.

2. Press **+1 YES** to continue this operation.

```

Sure? (yes/no)
SONG> 1 2 3 5 6

```

You now have a second chance to cancel this operation, and return to the Select Song display by pressing **-1 NO**.

3. Press **+1 YES** to clear all Songs. The LCD will show

```

COMPLETE !
SONG> 1 2 3 4 5 6

```

then return to the Select Song display.

3.5 COPY SONG

The Song Copy function lets you copy any selected Song to another destination in the RX17's Song memory. This is useful if you want to copy a Song in order to alter it to create a new Song, while retaining the original Song.

1. After selecting the Song you wish to copy, select Function 5.

```

COPY SONG 0 → * ?
SONG> 1 2 3 4 6

```

2. Use the Numeric Key Pad to enter the number of the Song destination to which the selected Song will be copied.

```

COPY SONG 0 → 1 ?
SONG> 1 2 3 4 6

```

3. Press **+1 YES**.

```

Sure? (yes/no)
SONG> 1 2 3 4 6

```

You can now cancel this operation by pressing **-1 NO**, if you do not wish to copy to the selected destination (for example, if it already contains data). The LCD will return to the Select Song display.

4. To copy the Song, press **+1 YES**. The LCD will show

```

COMPLETE !
SONG> 1 2 3 4 5 6

```

then return to the Select Song display.

3.6 SHOW REMAINING MEMORY

This function allows you to check the remaining Song memory of the RX17, as a percentage of its total Song memory capacity.

Press **SONG** and select Function 6.

```
REMAINING    090%  
SONG> 12345█
```

4.0 CASSETTE MODE

The function of the Cassette Mode is to let you save Patterns and Songs onto a normal cassette tape. This allows you to clear (erase) Patterns and Songs stored in the RX17's internal memory, and create new Patterns and Songs. You can then create an expanding cassette tape library of Patterns and Songs. At any time, you can load the Patterns and Songs from the tape into the RX17. The verify function allows you to check that the data has been correctly saved.

Saving is not the same as normal recording—the Patterns and Songs are saved in the form of complex digital data. Ideally, a computer data recorder should be used.

NOTE: You can also save Patterns and Songs to floppy disk, using the Bulk Dump function. See operation 5.7 TRANSMIT BULK.

4.0.1 CONNECTIONS

The RX17 should be connected to a cassette recorder using the supplied cassette cable. Connect the red cable to the cassette recorder's microphone input jack, the white cable to the cassette recorder's headphone output jack and the 8-pin DIN plug to the RX17's CASSETTE IN/OUT terminal.

4.0.2 ENTERING THE CASSETTE MODE

All cassette operations are preceded by pressing CAS to enter the Cassette Mode. The LCD will show

```
CASSETTE  SAVE  ?
CASS> █ 2 3
```

Function numbers

The Function numbers (1 thru 3) allow you to select the Cassette Mode's three Functions. This is done by using the ◀ or ▶ keys to move the cursor to the appropriate Function number. The LCD will then display the selected Function. You can also move the cursor by pressing **JOB** plus the Numeric Key corresponding to the Function number. If you press only **JOB**, the cursor will move to Function 1. To exit the Cassette Mode, press any other Mode key.

Cassette Mode Functions are numbered 4.1 thru 4.3 in this chapter.

4.0.3 ABORT CASSETTE OPERATION

At any time during a cassette operation, you can abort the operation by pressing **STOP/CONTINUE**. The LCD will show a "BREAK!" message. For example, if you are loading data into the RX17, but you suddenly realize that you want to preserve the data contained in the RX17's internal memory, you can abort the load operation. You can then clear the "BREAK!" display by pressing any Mode Key.

4.1 SAVE

This Function allows you to save the data of all 100 Patterns and 10 Songs stored in the RX17's internal memory.

1. Press **CAS**. The flashing cursor will indicate Function 1.

```
CASSETTE  SAVE  ?
CASS> █ 2 3
```

2. Make sure that a blank cassette is loaded into the cassette recorder, and the recording level is high. Start the cassette recorder running in the record mode. Press **+1 YES**.

```
Executing Now
CASSETTE  SAVE
```

It takes about one minute to save an average set of Pattern and Song data. After saving, the LCD will show

```
COMPLETE !
CASSETTE  SAVE
```

then return to the Cassette Function Select display.

3. Stop the cassette recorder. You should now execute operation 4.3 (Verify) to be sure that the data has been correctly saved.

4.2 LOAD

This Function allows you to load a complete set of Pattern and Song data from cassette into the RX17's internal memory.

NOTE: When you load data into the RX17, ALL Patterns and Songs in the internal memory will be erased. Be sure that you do not need this data, before you load the new data. If you need the data in the internal memory, save it to another cassette before loading new data.

1. Press **CAS** then select Function 2.

```
CASSETTE  LOAD  ?
CASS> 1 3
```

2. Make sure that the cassette containing the data is loaded into the cassette recorder, and is cued to playback from the beginning of the data you wish to load. Also make sure that the playback level is high. Press **+1 YES**.

```
Executing Now
CASSETTE  LOAD
```

3. Start the cassette recorder running in the play mode. It takes about one minute to load an average set of Pattern and Song data. After loading, the LCD will show

```
COMPLETE !
CASSETTE  LOAD
```

then return to the Cassette Function Select display.

4.3 VERIFY

This Function allows you to check that the data has been correctly saved onto tape, by comparing the data saved on tape with the data in the RX17's internal memory. It should be executed immediately after saving data.

1. Press **CAS** then select Function 3.

```
CASSETTE  VERIFY ?
CASS> 1 2
```

2. Make sure that the cassette containing the data is loaded into the cassette recorder, and is cued to playback from the beginning of the data you wish to verify. Press **+1 YES**.

```
Executing Now
CASSETTE  VERIFY
```

3. Start the cassette recorder running in the play mode. It takes about one minute to verify an average set of Pattern and Song data. After verifying, and provided the data has been correctly saved, the LCD will show

```
VERIFY OK !
CASSETTE  VERIFY
```

then return to the Cassette Function Select display.

Stop the cassette recorder.

5.0 MIDI MODE

The RX17 is fully compatible with all MIDI equipment. MIDI (Musical Instrument Digital Interface) is the technology that allows digital musical instruments to control each other. MIDI signals (data) are sent from one MIDI instrument to another, so that one instrument can "play" another instrument, or so that instruments such as sequencers and drum machines can be kept in perfect synchronization. You can even use MIDI to synchronize the RX17 to a tape recording.

NOTE: MIDI data can be sent on any of 16 MIDI Channels. The RX17 **MUST** be set to the same MIDI Channel(s) as the other MIDI device(s) to which it is connected. See 5.3 SET RECEIVE CHANNEL and 5.4 TRANSMIT CHANNEL ASSIGN.

The RX17 can utilize MIDI in the following ways:

- An external MIDI device such as a Yamaha QX5 or QX21 Digital Sequence Recorder can be used to start and stop playback and control the tempo of the RX17 (see 6.5.1, MIDI CLOCK IN).
- The RX17 can be used to start and stop playback and control the tempo of an external MIDI device such as a QX5 (see 6.5.2 MIDI CLOCK OUT).
- The RX17's instruments can be "played" by an external MIDI device such as a DX21, DX27, DX100 or DX7 Digital Programmable Algorithm Synthesizer (see 6.5.3 MIDI NOTE RECEIVE).
- The RX17 can "play" other MIDI units such as a DX21 or any X-series synthesizer, by sending MIDI Note information (see 6.5.4 MIDI NOTE TRANSMIT).
- You can send the entire Pattern and Song memory from one RX17 to another RX17, or to a Yamaha MDF MIDI Data Filer (see 5.6 RECEIVE BULK and 5.7 TRANSMIT BULK).
- The RX17 can function as part of a Tape Sync setup, where a special digital signal recorded on tape is used to synchronize MIDI instruments (see 6.5.5 TAPE SYNC).

5.0.1 ENTERING THE MIDI MODE

All MIDI operations are preceded by pressing **MIDI** to enter the MIDI Mode. The LCD will show

```

  SYNC   INTERNAL
  MIDI > █ 2 3 4 5 6 7 8
  
```

Function numbers

The Function numbers allow you to select the MIDI Mode's eight Functions. This is done by using the ◀ or ▶ keys to move the cursor to the appropriate Function number. The LCD will then display the selected Function. You can also move the cursor by holding **JOB** and pressing the Numeric Key corresponding to the Function number. If you press only **JOB**, the cursor will move to Function 1. To exit the MIDI Mode, press any other Mode key.

NOTE: All MIDI data set using Functions 5.1 thru 5.5, and 5.8 will be retained by the RX17 even if the power is turned off.

MIDI Mode Functions are numbered 5.1 thru 5.8 in this chapter.

5.1 SYNC

This Function allows you to set the RX17's synchronization to either of two modes:

INTERNAL. This is the normal RX17 mode. Pattern play and write, and Song play is synchronized to the RX17's internal clock, and tempo is adjusted using the RX17's own Tempo functions. This mode is also used when the RX17 is controlling other MIDI devices using MIDI signals transmitted from its MIDI OUT connector.

MIDI. This mode is used when the RX17 is synchronized to the MIDI clock in an external MIDI sequencer or music computer. MIDI signals are received via the RX17's MIDI IN connector. A Pattern or Song is selected on the RX17, and all PLAY, STOP, CONTINUE and TEMPO operations are controlled by the external device. The MIDI sync mode is also used when using the RX17 as part of a Tape Sync setup (see 6.5.5).

1. Press **MIDI**. The flashing cursor will indicate Function 1.

```

  SYNC   INTERNAL
  MIDI > █ 2 3 4 5 6 7 8
  
```

2. To set the Sync, press **+1 YES** to select MIDI, or **-1 NO** to select INTERNAL. The LCD will show the selected Sync Mode.

5.2 MIDI CHANNEL MESSAGE

This function must be turned ON to allow the RX17 to receive or transmit MIDI Note data (see 6.5.3 MIDI NOTE RECEIVE and 6.5.4 MIDI NOTE TRANSMIT).

1. Press **MIDI** then select Function 2.

```

  CH MESSAGE  ON
  MIDI > 1 █ 3 4 5 6 7 8
  
```

2. Press **+1 YES** to turn the Channel Message Function ON, or **-1 NO** to turn the Channel Message Function OFF.

5.3 SET RECEIVE CHANNEL

MIDI signals can be sent and received on any of 16 MIDI Channels. This Function allows you to select which MIDI Channel the RX17 will use for reception of MIDI signals when it is being "played" by an external MIDI keyboard, sequencer or music computer.

1. Press **MIDI** then select Function 3.

MIDI Channel number

RECEIVE CH = 01
MIDI > 1 2 3 4 5 6 7 8

2. Use the **-1 NO** and **+1 YES** keys to set the MIDI Channel number.

RANGE: 01 — 16.

5.4 TRANSMIT CHANNEL ASSIGN

This Function allows you to assign each of the RX17's 26 instruments to any one of the sixteen MIDI Channels, so that instruments can "play" one or more external MIDI devices. See 6.5.4 MIDI NOTE TRANSMIT for an application of this Function.

All 26 instruments can be assigned simultaneously, or you can assign instruments individually by omitting steps 3 and 4 of this operation.

1. Press **MIDI** then select Function 4.

TRANS CH ASSIGN ?
MIDI > 1 2 3 4 5 6 7 8

2. Press **+1 YES** to continue this Function.

Prompt to enter Channel number

ALL T. CH = ** ?
MIDI > 1 2 3 4 5 6 7 8

3. You can now use the Numeric Key Pad to select the MIDI Transmit Channel of all 26 instruments simultaneously. For example, MIDI Channel 10.

MIDI Transmit Channel number

ALL T. CH = 10 ?
MIDI > 1 2 3 4 5 6 7 8

4. Press **+1 YES** to enter the MIDI Transmit Channel for all instruments. The LCD will show

COMPLETE !
MIDI > 1 2 3 4 5 6 7 8

then return to the display for MIDI Function 1.

5. To set the MIDI Transmit Channel for individual instruments, execute Steps 1 and 2 of this Function, then press the instrument key corresponding to the instrument that is to be assigned. For example, Bass Drum.

Selected instrument MIDI Transmit Channel number

BD T. CH = 10
MIDI > 1 2 3 4 5 6 7 8

6. Use the **+1 YES** or **-1 NO** key to alter the displayed MIDI Transmit Channel number to the desired number.
7. You can now select another instrument, and assign it to a MIDI Transmit Channel. You can also use the Instrument Change Function (see operation 1.3) to change instruments, then return to this Function and assign them.

5.5 MIDI NOTE ASSIGN

This Function allows you to assign each instrument to a MIDI note, so that the RX17's instruments can play or be played by an external MIDI device. The available range is over five octaves — large enough for the entire range of most MIDI keyboards. See 6.5.3 MIDI NOTE RECEIVE, and 6.5.4 MIDI NOTE TRANSMIT for applications of this Function.

1. Press **MIDI** then select Function 5.

NOTE ASSIGN ?
MIDI > 1 2 3 4 5 6 7 8

2. Press **+1 YES** to continue this Function.

```

select INST
MIDI> 1234 6 78
  
```

3. Press the instrument key corresponding to the instrument that is to be assigned. For example, Bass Drum.

Selected instrument	MIDI Note number	MIDI Note
BD	A 1	(45)
MIDI> 1234 6 78		

6. Use the **+1 YES** or **-1 NO** key to set the MIDI Note. RANGE: C1 (36)—D#6 (99). Middle C is displayed as "C3 (60)".
7. You can now select another instrument, and assign it to a MIDI Note. You can also use the Instrument Change Function (see operation 1.3) to change instruments, then return to this Function and assign them.

5.6 RECEIVE BULK

This function allows you to receive the entire Pattern and Song Memory of another RX17. You can also receive the same data from a bulk data storage device such as a QX1 Digital Sequence Recorder or an MDF1 MIDI Data Filer.

NOTE: When the data is received, the entire Pattern and Song data that was in the RX17 will be erased. If this data is important, it should be saved to cassette or floppy disk before the Bulk Dump operation (see 4.1 CASSETTE SAVE or 5.7 TRANSMIT BULK).

1. Connect the MIDI IN of the RX17 to the MIDI OUT of the transmitting RX17 or other device.
2. Press **MIDI**, then select Function 6.

```

RECEIVE BULK ?
MIDI> 12345 7 8
  
```

3. Press **+1 YES** to set the RX17 to Receive Bulk Dump.

```

Ready
BULK RECEIVE
  
```

4. During transmission, which takes a few seconds, and is executed from the transmitting RX17 (or QX1, MDF1 or similar device) the LCD will show

```

Executing Now
BULK RECEIVE
  
```

followed by

```

COMPLETE !
BULK RECEIVE
  
```

5. If you wish to abort the Bulk Dump, press **STOP/CONTINUE**. The LCD will show a "BREAK!" DISPLAY. Press any Mode key to clear the "BREAK" display.

5.7 TRANSMIT BULK

This function allows you to quickly transmit the entire Pattern and Song Memory of the RX17 to another RX17. The data is not actually transferred, rather, it is copied into the second RX17. You can also transmit the data into a bulk data storage device such as a QX1 Digital Sequence Recorder (for floppy disk storage), or an MDF1 MIDI Data Filer (for Quick Disk storage).

1. Connect the MIDI OUT of the transmitting RX17 to the MIDI IN of the receiving RX17 or bulk data storage device.
2. Set the receiving RX17 to Receive Bulk Dump (see operation 5.6), if transmitting to a second RX17.
3. Press **MIDI**, then select Function 7.

```

TRANSMIT BULK ?
MIDI> 123456 8
  
```

4. Press **+1 YES** to execute the Bulk Dump Transmit. For a few seconds the LCD will show

```

Executing Now
BULK TRANSMIT
  
```

followed by

```

COMPLETE !
BULK TRANSMIT
  
```

then return to the display for MIDI Function 1. The data has now been transmitted to the receiving RX17.

- If transmitting data to a QX1, you can also execute the actual transmission by sending a "Bulk Dump Request" from the QX1. In this case, the MIDI OUT of the QX1 must be connected to the MIDI IN of the RX17, as well as the QX1's MIDI IN to the RX17's MIDI OUT.

5.8 ECHO BACK

This function allows you to set the RX17's MIDI OUT connector to act as a MIDI THRU connector. Any MIDI signals received at the MIDI IN connector will be output unchanged via the MIDI OUT connector. See 6.5.1 MIDI CLOCK IN and 6.5.3 MIDI NOTE RECEIVE for applications of this Function.

1. Press **MIDI** then select Function 8.

```
ECHO BACK OFF
MIDI > 1 2 3 4 5 6 7
```

2. Press **+1 YES** to turn the Echo Back Function ON, or **-1 NO** to turn the Echo back Function OFF

6.0 HINTS AND TIPS

This chapter contains a variety of useful hints, some essential, some creative, to add to your enjoyment of the RX17. These will give you useful knowledge to encourage you to go beyond the limitations of this manual and create your own music. The RX17, in spite of its compact dimensions, has enormous potential!

6.1 THE INSTRUMENTS

6.1.1 LATIN PERCUSSION INSTRUMENTS

The RX17's instruments include 14 exciting Latin percussion sounds, in addition to the 12 basic drum sounds. Latin percussion appears in all types of contemporary music, from reggae to rock and jazz.

In general, Latin percussion is used in two basic ways: to provide sudden bursts of colourful timbres in a song, or to add a steady beat to your music. It can be difficult to play rapid Latin-style breaks or rolls in Real Time Write, so the Step Write Mode allows even the inexperienced musician to create impressively complex passages.

CONGAS. The RX17's three Conga sounds are effective when used together. Congas usually come in pairs, and conga players rarely play both congas simultaneously. A characteristic action of conga players is to play the two congas alternately, or play one beat on one conga, and two on the other, to create varying patterns. The high conga has two sounds on the RX17, muted and open for further effectiveness.

BONGOS. Less powerful than congas, but equally effective, the light sound of bongos can add drive to a straight rock number, or rhythmic interest to a medium-tempo song.

AGOGO. The agogo is often used to create the characteristic samba rhythm, with alternating high and low notes. It should be used sparingly, as its piercing metallic tone cuts through any musical setting.

COWBELL. A steady four beats to a bar on a cowbell can really move a song, while fast rhythmic playing will add spice to an adlib section.

WHISTLE. The whistle is used humorously in Latin music to start off a song, or signal the end of a solo or verse, with a few quick blasts.

SHAKER. The shaker is most commonly used to provide a steady 8th-note rhythm behind an up-tempo song. Use it at a lower level, so that it will blend in with the musical fabric.

TIMBALES. Timbales have great impact and are often used to greatest effect in sudden splashes of 16th notes, or in syncopations with odd rests in between, to add energy to any song.

CUICA. A fascinating sound caused by rubbing a stick connected to the inside of the drumskin, the cuica adds color to any music. Ideally, it's best used to highlight just one section of a song — for example, a solo.

6.2 PATTERN OPERATIONS

6.2.1 INSTRUMENT CHANGE

While writing a Pattern, you can change an instrument and record the new instrument into the same Pattern, even on the same beat as the old instrument. So you can use all 26 RX17 instruments in a Pattern.

For example, after entering a Bass Drum part in Step Write, press **INST CHANGE**. Press BD twice, to select Tambourine. Press **INST CHANGE** again to return to Step Write. You can now enter a tambourine part, even on beats where a Bass Drum part has been entered.

If you attempt to enter more than 11 instruments on one beat, previously entered instruments will be cleared (erased). However, the following instruments have priority, and will not be cleared: BD, SD, RIMSHOT, HH Open, HH Closed, RIDE, CRASH.

NOTE: The maximum number of instruments that can be played on the same beat is 11.

6.2.2 QUANTIZE APPLIED TO STEP WRITE

In Step Write, Quantize is a time-saver because it minimizes the number of rests you need to enter. Although your Pattern may contain a complex arrangement of rhythms, you can save Pattern writing time by writing each instrument in at the appropriate Quantize setting.

Use a Quantize setting of 1/8 to enter basic parts such as Bass Drum and Snare Drum. Reset Quantize to 1/16 or even 1/32 to enter complex or rapid parts such as Hi-Hat or Bongo. For triplets, use a Quantize setting of 1/12 or 1/24.

Using a high Quantize setting allows you to add subtle timing variations. For example, many rock drummers create an exciting feel by slightly delaying their off-beat on the snare drum. This is easy to create in the Step Write Mode. In this example, the Snare Drum is entered using a Quantize rate of 1/48. The 2nd and 4th quarter-notes fall at beats 13 and 37 respectively, so the Snare Drum notes are entered at beats 14 and 38 to provide the delay.

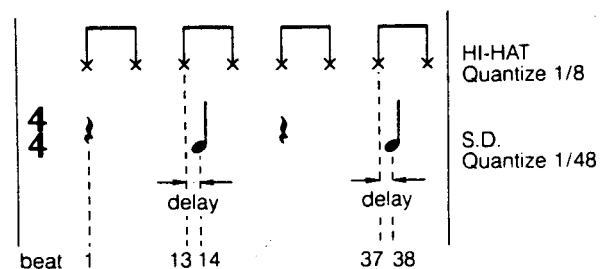

6.2.3 QUANTIZE APPLIED TO REAL TIME WRITE

In Real Time Write, Quantize automatically corrects each part that you enter, to a selected minimum note length. This makes the writing of perfectly-timed Patterns easy and rapid. For example, you could set the Quantize to 1/8 and write in a simple Bass Drum figure. Even if you play the notes off the beat, you'll hear them sound exactly on the beat as soon as the Pattern recycles.

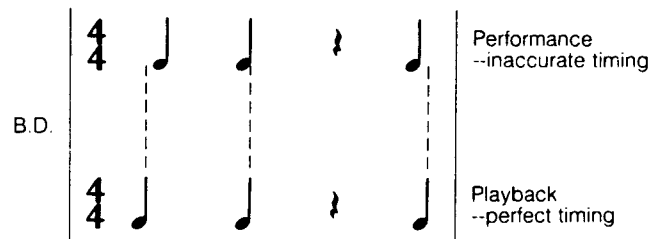

Keep the Quantize at 1/8 while you write the Snare Drum part. Then without stopping Real Time writing, change the Quantize to 1/16 and add a complex Hi-Hat part, to complete a precisely-timed Pattern. The first Hi-Hat note in this example is open (the rest are closed).

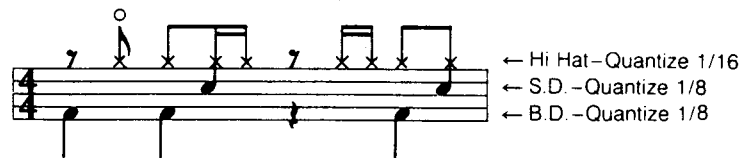

The higher Quantize settings (1/24, 1/32, 1/48) allow you to enter more subtle or complex parts. If the Quantize is set to 1/48, the RX17 will be recording your music in increments of 1/48th notes, which are short enough to capture all the timing subtleties of your original performance.

6.3 SONG OPERATIONS

6.3.1 LONG ACCELERANDO/RITARDANDO

The maximum duration of a Tempo Change is 99 quarter-notes, so if you want a longer Tempo Change, you'll need to enter more than one Tempo Change. For example, if you wanted a gradual accelerando from 100 to 150 over a period of 32 bars of 4/4 (128 quarter notes) you could enter two Tempo changes: the first one with a Tempo Change Value of 25 and a duration of 64 quarter notes; and a second identical one 16 bars later. A convenient method is to enter a Tempo Change during a repeat section. The Tempo Change will also be repeated, allowing you to make a gradual Tempo Change over a long period (keep in mind that the Tempo range of the RX17 is 40—250 quarter-notes/minute).

6.3.2 FADE-OUTS/FADE-INS

Volume Changes are instantaneous. You can create gradual Volume Changes by entering several small Volume Changes at close intervals (for example, one at every bar). However, a more convenient method is to enter a Volume Change during a repeat section.

For example, here's how you can create a fade-in or fade-out:

1. Enter in Part 001 of a Song, a Volume Change of -31 . This would reduce the level to zero, i.e., silence.
2. Enter a Volume Change of $+4$ during the initial section of the Song, a section that is repeated 8 times. By the end of the repeats, the Volume Level would be -31 plus $32 (8 \times 4) = +1$.
3. A similar fade-out could be done by entering a Volume Change of -4 in a final section of the Song which is also repeated 8 times.

6.4 CASSETTE OPERATIONS

6.4.1 CREATIVE WAYS TO SAVE DATA

You could organize your data cassettes so that each cassette contains data for a specific style of Patterns: Jazz, Rock, Reggae, Fusion, etc.

Or you could save, on a single cassette, the data for an entire performance, with the Patterns and Songs arranged in the order in which the songs appear in your performance. Then it's an easy matter to alter the running order of the Songs and Patterns, using 2.6 COPY PATTERN and 3.5 COPY SONG, and save the new arrangement on a second cassette.

The best way to save data is to save each set of data onto a separate cassette tape. Short cassette of 5-10 minutes' duration, designed for computer data storage, are ideal. You can also save several sets of data onto a single cassette, but be sure to leave several seconds' gap between each set of data.

6.5 MIDI OPERATIONS

6.5.1 MIDI CLOCK IN

A MIDI "clock" is what controls the rate that MIDI events occur. In other words, the tempo of the RX17. This is usually controlled by the RX17's internal clock. You can also use the clock of an external MIDI device to control the RX17. This enables you to keep the RX17's rhythms in synchronization with another rhythm programmer, or with digital music that is being played on a sequencer or music computer.

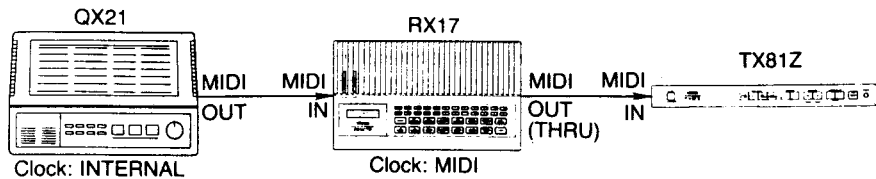
APPLICATION EXAMPLE: RX17 plus QX21 plus TX81Z

For this MIDI application use 5.1 SYNC to set the RX17's sync mode to MIDI. Also, use 5.8 ECHO BACK to turn ON the "Echo Back" feature, so as to allow the QX21's MIDI signals to be passed to the TX81Z via the RX17's MIDI OUT connector, which will be acting as a MIDI THRU terminal.

In this example, the RX17 is controlled by a QX21 Digital Sequence Recorder, which is also controlling a TX81Z Multi-Timbral FM Tone Generator (which provides 160 state-of-the-art FM voices featuring simulated Reverb, variable waveform operators and variable intonation). Digital music data is recorded into the QX21.

When you start play on the QX21, the RX17 will also start play (either Pattern Play, or Song Play, according to whether you have selected a Pattern or Song on the RX17). The Pattern or Song will have been programmed to fit the music stored in the QX21.

The RX17 will continuously receive MIDI Clock signals from the QX21, to keep both units in perfect synchronization. If you change the Tempo on the QX21, the RX17 will also change tempo. The RX17 will automatically stop playing when the music ends, or when you press **STOP/CONTINUE** on the QX21.

6.5.2 MIDI CLOCK OUT

You can use the RX17's internal clock to control the playback and tempo of an external MIDI device such as a sequencer, music computer or another rhythm programmer.

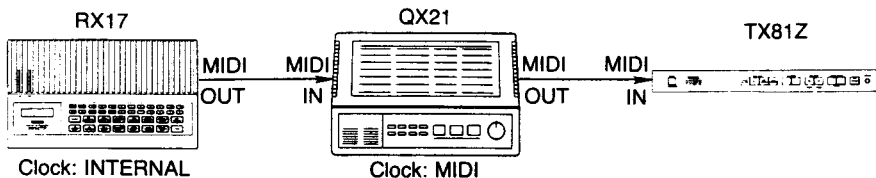
APPLICATION EXAMPLE: RX17 plus QX21 plus TX81Z.

For this MIDI application, use 5.1 SYNC to set the RX17's sync mode to INTERNAL CLOCK.

In this example, the RX17 is controlling a QX21 Digital Sequence Recorder, which is in turn controlling a TX81Z FM Tone Generator. Digital music data is recorded into the QX21.

When you start play on the RX17, the QX21 will also start play. The RX17 will continuously send MIDI Clock signals to the QX21, to keep both units in perfect synchronization. If you change the Tempo on the RX17, the QX21 will also change tempo. The QX21 will automatically stop playing when the RX17's Song ends, or when you press **STOP/CONTINUE** on the RX17.

6.5.3 MIDI NOTE RECEIVE

Each of the RX17's 26 instruments can be assigned to a different MIDI Key. You can then "play" each instrument from a MIDI keyboard, sequencer or music computer. For example, if you set the RX17's Cowbell to C3 (Middle C), whenever you play Middle C on a DX21, or send Middle C data from a sequencer or music computer, you'll hear the RX17's Cowbell.

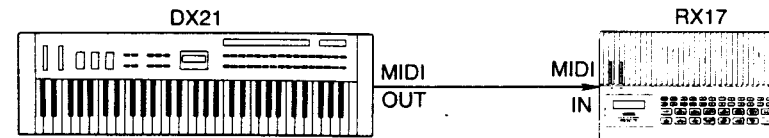
APPLICATION EXAMPLE #1: RX17 plus DX21

For this MIDI application, use the following Functions:

- 5.2 MIDI CHANNEL MESSAGE to allow the RX17 to receive MIDI Key data.
- 5.3 SET RECEIVE CHANNEL to set the RX17's MIDI Receive Channel to the same MIDI channel as the DX21.
- 5.5 MIDI NOTE ASSIGN to assign the RX17's instruments to keys on the DX21.

You could set the DX21 to Keyboard Split, and adjust its balance so that no sound is output from the left hand section of the keyboard. With the RX17's instruments assigned only to keys on the left hand section of the DX21's keyboard, you could then play the DX21 so that your left hand plays only the RX21, while your right hand plays a melody on the DX21.

NOTE: This MIDI setup allows you use a MIDI keyboard to write Patterns in real time on the RX17. Key Velocity data will be received by the RX17, so the harder you play a key, the higher will be the Accent Level of the note you have entered (in other words, the note will be louder). The actual relationship between Key Velocity and Accent Level is as follows:

$$\text{Accent Level} = (\text{Key Velocity} / 4) - 16.$$

For example, a Key Velocity of 0 (the minimum possible) will produce an Accent Level of -16. A Key Velocity of 100 will produce an Accent Level of +9.

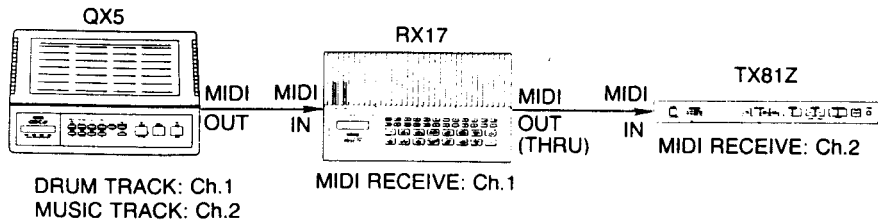
APPLICATION EXAMPLE #2: RX17 plus QX5 plus TX81Z

For this MIDI application, use the following Functions:

- 5.2 MIDI CHANNEL MESSAGE to allow the RX17 to receive MIDI Key data.
 - 5.3 SET RECEIVE CHANNEL to set the RX17's MIDI Receive Channel to 1.
 - 5.5 MIDI NOTE ASSIGN to assign the RX17's instruments to MIDI Keys.
 - 5.8 ECHO BACK to turn ON the "Echo Back" feature, so as to allow the QX5's MIDI signals to be passed to the TX81Z via the RX17's MIDI OUT connector, which will act as a MIDI THRU connector.
- The TX81Z's MIDI Receive Channel should be set to 2.
Music is recorded onto the QX5 in two separate tracks (the QX5 can store up to 8 tracks of music data). Track 1 will contain the RX17's "drum track", on MIDI Channel 1, using only pitches corresponding to the RX17's instruments. Track 2 will contain an 8-part polyphonic music track for the TX81Z, on MIDI Channel 2.
When you start play on the QX5, music data from track 1 will cause the RX17 to play, while music data from track 2 will cause the TX81Z to play.

6.5.4 MIDI NOTE TRANSMIT

Each of the RX17's instruments can transmit a MIDI note number, so you can use the RX17 to "play" a MIDI keyboard or Tone Generator. In this case the RX17 would be acting as a kind of sequencer. You can assign instruments to pitches that will cause the external MIDI device to play a riff when an RX17 Pattern is played, or an extended melody when a Song is played. You can even assign the RX17's instruments to different MIDI channels, allowing you to use the RX17 to control up to 16 external MIDI devices!

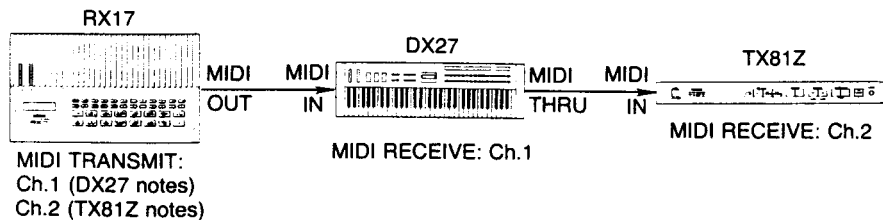
APPLICATION EXAMPLE: RX17 plus DX27 plus TX81Z

For this MIDI application, use the following Functions:

- 5.1 SYNC to set the RX17's sync mode to MIDI.
- 5.2 MIDI CHANNEL MESSAGE to allow the RX17 to transmit MIDI Key data.
- 5.4 TRANSMIT CHANNEL ASSIGN to assign some of the RX17's instruments to MIDI Channel 1 and some to MIDI Channel 2.
- 5.5 MIDI NOTE ASSIGN to assign the RX17's instruments to MIDI Keys, causing selected pitches to sound on the DX27 and TX81Z.

When you play a Pattern or Song on the RX17, the DX27 will play notes assigned to RX17 instruments transmitting on MIDI Channel 1, while the TX81Z plays notes assigned to RX17 instruments transmitting on MIDI Channel 2. So the RX17 is creating two separate tracks of digital music—and of course you can manually play the DX27 at the same time.

6.5.5 TAPE SYNC

The RX17 can function as part of a Tape Sync setup, where an FSK (Frequency Shift Keying) signal recorded on tape can be used to synchronize MIDI instruments.

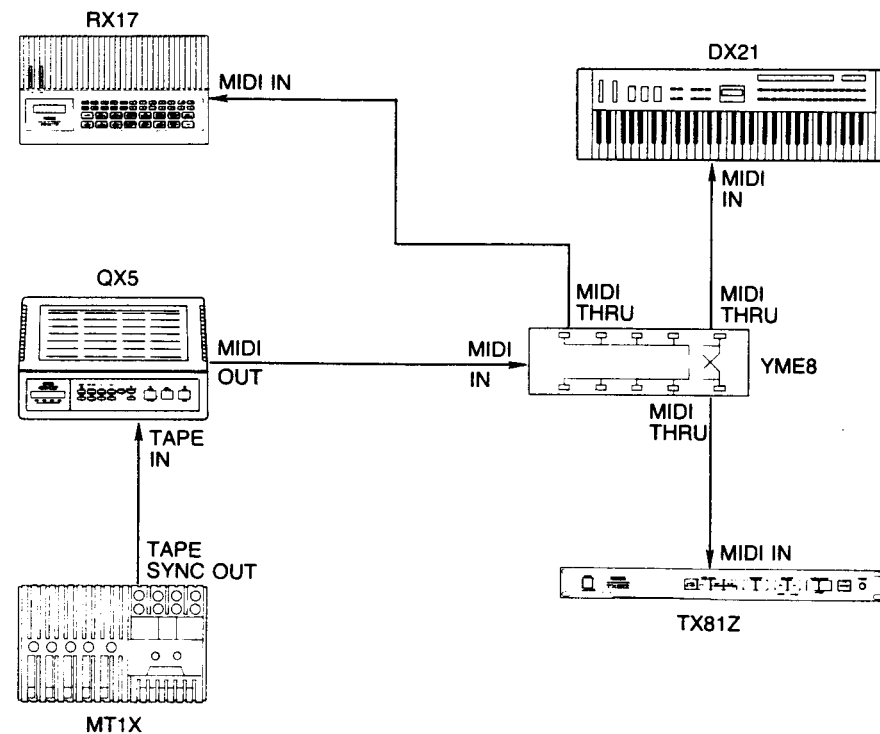

In the example shown the RX17 is being used with a Yamaha MT1X Multitrack Cassette Recorder, a QX5 Digital Sequence Recorder, a DX21 Digital Programmable Algorithm Synthesizer and a TX81Z Multi-Timbral FM Tone Generator. A YME8 MIDI Expander allows the QX5 to send MIDI data to the RX17, the DX21 and the TX81Z.

First, a music sequence is recorded on the QX5 (which can record up to eight tracks of music, each of which could control one of the TX81Z's voices). When the music sequence is played back, the QX5 transmits a Tape Sync signal via its TAPE OUT connector, which is recorded onto track 1 of the MT1X.

The recorded Tape Sync signal is then used to control playback of the QX5 (via the TAPE IN connector on the QX5). The QX5 sends its music data via the YME8 to the DX21 and the TX81Z on separate MIDI channels. The QX5 also controls playback of the RX17 (which has its Sync Mode set to MIDI). A Song is programmed on the RX17 to match the music sequence on the QX5, and the Song can be edited, while both units remain in perfect synchronization.

The other three tracks on the MT1X are used to record acoustic instruments and vocals, while listening to the RX17, DX21 and TX81Z. Finally, just by pressing the Play button on the MT1X, the recorded tracks are heard, the DX21 and TX81Z start to generate music from data in the QX5, and the RX17 adds authentic percussion sounds to the music. In this way the worlds of MIDI and acoustic music are combined in a simple yet powerful, sophisticated Yamaha music system. For further explanation, see the Owner's Manuals of the equipment used in this example, and consult the Yamaha Multitrack Guidebook and Yamaha MIDI Book.

ERROR MESSAGES

Sometimes you may see an unusual message on the RX17's LCD, indicating that an operation has been executed wrongly, or there is a technical malfunction. This chart lists those messages, their causes and remedies.

MESSAGE	CAUSE	REMEDY
* init PARAM. *	A malfunction in the RX17 has caused all parameters (voice level, accent level, pan, MIDI settings) to be initialized.	
* illegal PTN * or * illegal SONG*	A malfunction in the RX17 has caused all Pattern and Song data to be cleared.	Use operation 2.1.2 to load the Preset Patterns and Songs, or operation 4.2 to load Patterns and Songs saved on cassette.
! ERROR !	During MIDI Bulk Receive, incorrect data was sent due to faulty cable or electrical interference.	Check that the MIDI cable is not faulty. Also, read the PRECAUTIONS section of this manual for advice on electrical interference.
! LOAD ERROR !	There is a checksum error in sequence data that you have tried to load from cassette, due to a fault in transmission.	Repeat the Load operation, making sure that the tape playback level is high. Also, check that the cassette cable is functioning correctly. If necessary, clean and demagnetize the tape heads.
! VERIFY ERROR !	The RX17 contains different data to the data saved on cassette.	Make sure that the cassette you are using contains data that was just saved. If there is still a problem, save the data again and execute the Verify operation once more.
! Different Type !	During Bulk Receive, you are sending data to the RX17 that is not formatted for the RX17.	Make sure that the MIDI device connected to the RX17 is transmitting the correct type of data (i.e. RX17 Pattern, Song and Instrument data).
! Data Destroyed !	During Bulk Receive or Cassette Load, you have cleared all data in the RX17 by attempting to load the wrong type of data.	Make sure that the type of data you are loading is correct for the RX17, then execute the load operation again.
! MIDI BUFFER ! ! FULL !	Too large amounts of MIDI data are being sent to the RX17 too rapidly.	Press any key to clear the LCD. Send less dense data, or send data at a slower tempo.
! MEMORY FULL !	The RX17's Pattern or Song Memory is full, and further data cannot be entered.	Use operation 4.1 to save the Pattern and Song data to cassette, then use operation 2.4 to clear Patterns, or operation 3.3 to clear Songs, prior to entering new data.
! TOO LARGE PTN !	You have exceeded the maximum size of a Pattern, and further data cannot be entered.	Write two or more shorter Patterns, each of which forms a section of the Pattern you were trying to write. Then use operation 3.2 to combine the short Patterns into a Song.
Part Overflow !	You have entered data in the Copy Part function which would result in a Song containing more than 999 Parts.	See if you can enter repeats in the Song to bring it up to the required length.
Illegal Input !	1. You have entered Part numbers in the Copy Part function where the second Part number is smaller than the first. 2. You have entered Part numbers in the Copy Part function which include the destination Part number.	1. Enter correct Part numbers. 2. Copy a different group of Parts so that the destination Part is outside the Parts to be copied.
! CHANGE BATTERY !	You have entered a Part number in the Copy Part function which is higher than the total number of Parts in the Song.	Enter the correct Part number.
! NO BATTERY !	You have tried to change the length of a Pattern that already contains data.	Write a new Pattern at the desired Pattern length.
End of SONG !	The lithium battery, for memory backup, is running at less than 2.2 V.	Press +1 YES to restore the RX17 to normal operation. Consult your Yamaha dealer about battery replacement.
Not Found !	The lithium battery, for memory backup, is running at less than 1.5 V.	Press +1 YES to restore the RX17 to normal operation. Consult your Yamaha dealer about battery replacement as soon as possible.
! Already Set !	1. In the Copy Part function, you have entered a copy destination Part number that is higher than the total number of Parts in the Song. 2. In the Search Part function, you have entered a Part number that is higher than the total number of Parts on the Song.	1. The LCD will next display the empty Part following the last Part of the Song. Continue the Copy Part operation to copy to this Part, or enter a new Part number. 2. The LCD will next show the empty Part following the last Part of the Song. You can now edit from this point, or select the Search Part function again in the normal way.

SPECIFICATIONS

SOUND SOURCE

ROM: PCM, 2 MBYTE ROM

NUMBER OF VOICES

26

MEMORY CAPACITY

PATTERNS: 100

SONGS: 10 (UP TO 999 PARTS PER SONG.

TOTAL SONG MEMORY: 1200 PARTS)

CONTROLLERS

KEYS: PATTERN, SONG, CAS, MIDI, JOB, LEVEL, PAN, INST CHANGE, TEMPO, BEAT

CLEAR, NUMERIC KEYS (10, NUMBERED 0—9), -1 NO. +1 YES, ◀, ▶, STOP/

CONTINUE, START, ACQENT, INSTRUMENT KEYS (13, DUAL-FUNCTION)

SLIDERS: VOLUME, TEMPO

DISPLAY

LCD: 16 CHARACTERS × 2 ROWS

CONNECTIONS

5-PIN DIN: MIDI IN, MIDI OUT

8-PIN DIN: CASSETTE IN/OUT

STEREO 1/4" PHONE JACK: HEADPHONES

MONO 1/4" PHONE JACK: AUDIO OUT R, L (MONO)

DC 9—12V IN (TIP POSITIVE)

SUPPLIED ACCESSORIES

PA-1 12V POWER CONVERTOR

CRC-1 CASSETTE INTERFACE CABLE

DIMENSIONS (W × H × D)

350 × 54.5 × 202mm (13 25/32" × 2 5/32" × 7 31/32")

WEIGHT

1.4 kg (3 lbs 7 oz.)

Specifications are subject to change without notice.

BLOCK DIAGRAM

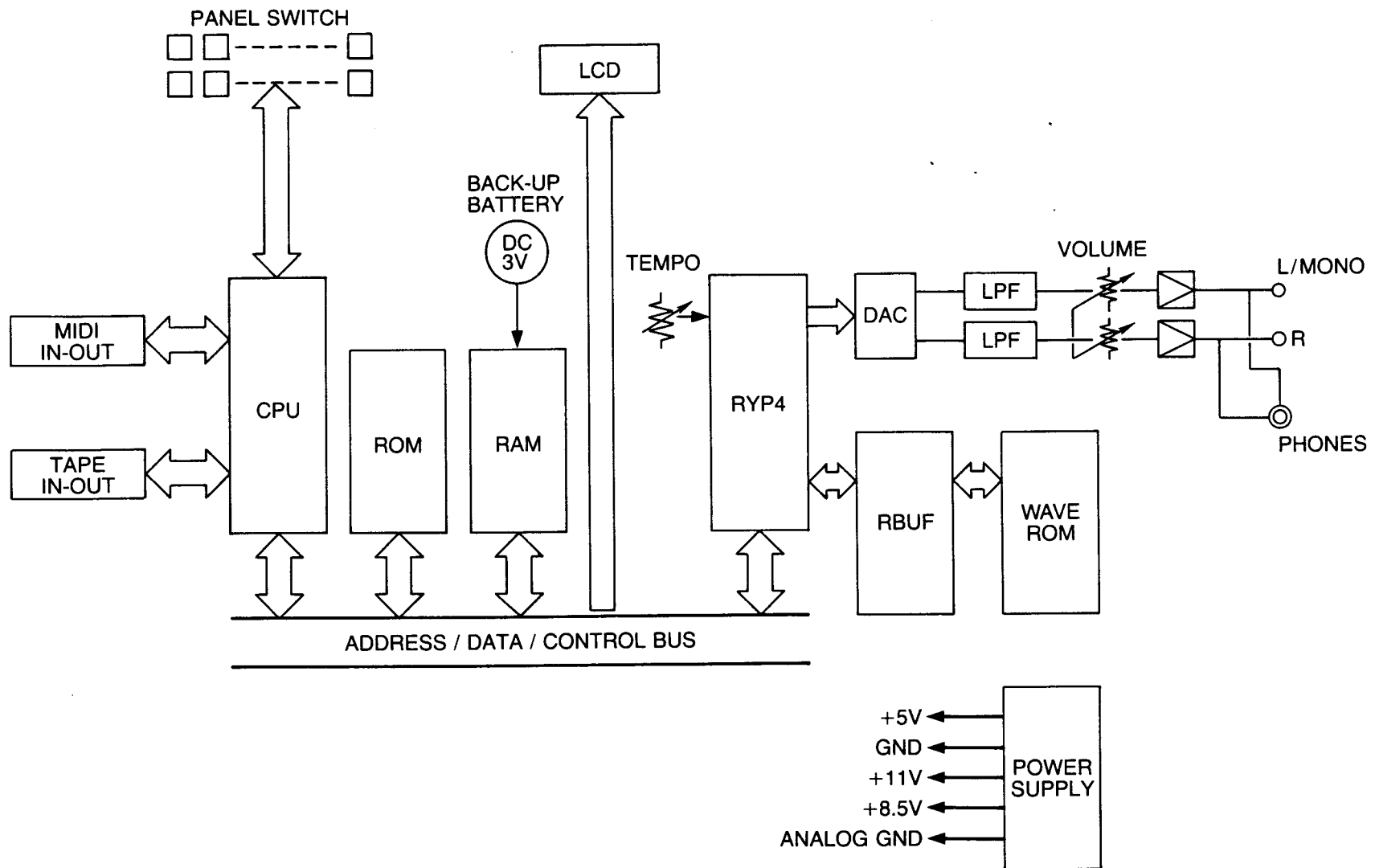

MIDI IMPLEMENTATION CHART

Function ...	Transmitted	Recognized	Remarks
Basic Default	1 - 16	1 - 16	memorized
Channel Changed	1 - 16	1 - 16	
Default	3		
Messages	x	x	
Altered	XXXXXXXXXXXXXX	x	
Note	36 - 99	X1 36 - 99	X1
Number : True voice	XXXXXXXXXXXXXX	36 - 99	
Velocity Note ON	0 9nH, v=1-127	0 v=1-127	
Note OFF	x 8nH, v=64	x	
After Key's	x	x	
Touch Ch's	x	x	
Pitch Bender	x	x	
	x	x	
Control			
Change			
Prog	x	x	
Change : True #	XXXXXXXXXXXXXX	x	
System Exclusive	0	0	X2 : Pattern, Song
System : Song Pos	x	0	
Song Sel	0 0 - 9	0 0 - 9	
Common : Tune	x	x	
System : Clock	0	0 (MIDI mode)	
Real Time : Commands	0	0	
Aux : Local ON/OFF	x	x	
All Notes OFF	x	x	
Mes- : Active Sense	x	x	
ages:Reset	x	x	
Notes: When ECHO BACK switch is on, all messages except System Exclusive are bypassed to MIDI out. X1 = When CH message switch is on, note number 36 - 99 which assigned to each instrument are recognized or transmitted. X2 = When BULK RECEIVE is ready, Sys Ex messages are recognized.			
Mode 1 : OMNI ON, POLY	Mode 2 : OMNI ON, MONO	0 : Yes	
Mode 3 : OMNI OFF, POLY	Mode 4 : OMNI OFF, MONO	x : No	

RX17 SONG CHART

SONG NO.: NAME: INITIAL TEMPO: ♩ =

PART	PTN	OTHER DATA	PART	PTN	OTHER DATA	PART	PTN	OTHER DATA	PART	PTN	OTHER DATA
001			033			065			097		
002			034			066			098		
003			035			067			099		
004			036			068			100		
005			037			069			101		
006			038			070			102		
007			039			071			103		
008			040			072			104		
009			041			073			105		
010			042			074			106		
011			043			075			107		
012			044			076			108		
013			045			077			109		
014			046			078			110		
015			047			079			111		
016			048			080			112		
017			049			081			113		
018			050			082			114		
019			051			083			115		
020			052			084			116		
021			053			085			117		
022			054			086			118		
023			055			087			119		
024			056			088			120		
025			057			089			121		
026			058			090			122		
027			059			091			123		
028			060			092			124		
029			061			093			125		
030			062			094			126		
031			063			095			127		
032			064			096			128		

"Other Data" includes Volume Changes, Tempo Changes and Repeats.

QUICK GUIDE

Use this Quick Guide as a rapid reference index to enable you to find any operation on the RX17. For convenience, an operation may be listed under more than one entry. For example, "Pattern Length" also appears under "Length of Pattern" and "Time Signature". This index also includes references to parts of the HINTS AND TIPS chapter, for extra commentary and advice.

ABOUT BULK DUMP	5.6	ECHO BACK	5.8	MIDI RECEIVE CHANNEL	5.3	Song	3.6
ABORT CASSETTE	4.0.3	EDIT ACCENT	2.3.8	NOTE ASSIGN (MIDI)	5.5	REPEATS	3.2.3
ACCELERANDO	3.2.4	EDIT SONG	3.2	NOTE DELETE		RITARDANDO	3.2.4
Hint	6.3.1	ENTERING NOTES		Real Time Write	2.2.4	Hint	6.3.1
ACCENT EDIT	2.3.8	Real Time Write	2.2.4	Step Write	2.3.6	SAVE DATA TO CASSETTE	4.1
ACCENT LEVEL	1.4.3	Step Write	2.3.4	NOTE MARKERS	2.3.4	Hint	6.4.1
BULK		FADE OUT/IN	6.3.2	PAN	1.6.1	SEARCH PART	3.2.7
Receive	5.6	INITIAL TEMPO	3.2.6	PART COPY	3.2.8	SELECT PATTERN	2.1
Transmit	5.7	INSERT PART	3.2.10	PART DELETE	3.2.9	SELECT SONG	3.1
CASSETTE		INSTRUMENT CHANGE		PART INSERT	3.2.10	SONG CHART	
Save	4.1	All instruments	1.3.1	PART SEARCH	3.2.7	Use of	3.1.2
Load	4.2	Single instrument	1.3.2	PATTERN CHART		SONG CLEAR	
Verify	4.3	INSTRUMENT DELETE	2.3.7	Use of	2.1.3	Single Song	3.3
CHANGE INSTRUMENT		INSTRUMENT LEVEL	1.4.2	PATTERN CLEAR		All Songs	3.4
All instruments	1.3.1	INTERNAL CLOCK	5.1	Single Pattern	2.4	SONG COPY	3.5
Single instrument	1.3.2	LATIN PERCUSSION (HINTS)	6.1.1	All Patterns	2.5	SONG EDIT	3.2
Hint	6.2.1	LENGTH OF PATTERN	2.2.2	PATTERN COPY	2.6	SONG MEMORY	
CHANNEL MESSAGE (MIDI)	5.2	LEVEL		PATTERN ENTRY		Remaining Memory	3.6
CHARTS, USE OF		Click	1.4.1	As Part of Song	3.2.2	SONG PLAY	3.1.1
Pattern	2.1.3	Instrument	1.4.2	PATTERN LENGTH	2.2.2	SONG SELECT	3.1
Song	3.1.2	Accent	1.4.3	PATTERN MEMORY		STEP WRITE	2.3
CLEAR PATTERN		LOAD		Remaining memory	2.7	SYNC SETTING	5.1
Single Pattern	2.4	To cassette	4.2	PATTERN PLAY	2.1.1	SYNC TO TAPE	6.5.5
All Patterns	2.5	Preset Patterns/Songs	2.1.2	PATTERN SELECT	2.1	TAPE SYNC	6.5.5
CLEAR SONG		MEMORY REMAINING		PLAY PATTERN	2.1.1	TEMPO CHANGE	3.2.4
Single Song	3.3	Pattern	2.7	PLAY SONG	3.1.1	Hint	6.3.1
All Songs	3.4	Song	3.6	PRESET PATTERNS/SONGS		TEMPO, INITIAL	3.2.6
CLICK LEVEL	1.4.1	MIDI CHANNEL MESSAGE	5.2	Loading operation	2.1.2	TEMPO SETTING	1.7.1
CLOCK SETTING	5.1	MIDI CLOCK		QUANTIZE SETTING		TIME SIGNATURE	2.2.2
COPY PART	3.2.8	Sync setting	5.1	Real Time Write	2.2.3	TRANSMIT BULK	5.7
COPY PATTERN	2.6	Clock in: Hint	6.5.1	Step Write	2.3.3	TRANSMIT MIDI	
COPY SONG	3.5	Clock out: Hint	6.5.2	QUANTIZE: HINTS		MIDI Channel	5.4
DELETE INSTRUMENT	2.3.7	MIDI NOTE		Step Write	6.2.2	MIDI Note	6.5.4
DELETE NOTE		Assign	5.5	Real Time Write	6.2.3	VERIFY CASSETTE DATA	4.3
Real Time Write	2.2.5	Receive: Hint	6.5.3	REAL TIME WRITE	2.2	VOLUME CHANGE	3.2.5
Step Write	2.3.6	Transmit: Hint	6.5.4	RECEIVE BULK	5.6	"X" MARKERS	2.3.10
DELETE PART	3.2.9	MIDI OUT/THRU		RECEIVE CHANNEL (MIDI)	5.3		
DOT DISPLAY	2.3.4	Echo Back	5.8	REMAINING MEMORY			
Long Pattern	2.3.9	MIDI TRANSMIT CHANNEL	5.4	Pattern	2.7		
"X" markers	2.3.10						