

RX-A3000

Quick Reference Guide

Accessories

The following accessories are supplied with this product.

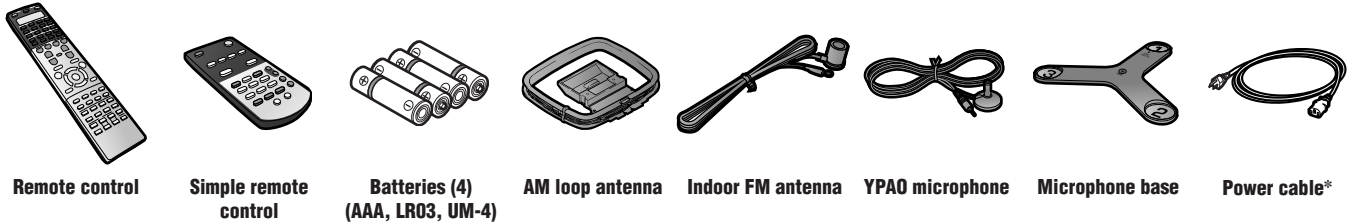

*The figure of the supplied power cable may differ depending upon regions.

Preparing the remote control

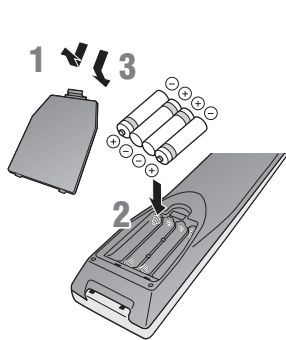

- 1 Take off the battery compartment cover.
- 2 Insert the four supplied AAA batteries into the battery case, following the polarity markings.
- 3 Snap the battery compartment cover back into place.

Be sure to aim the remote control directly at the remote control sensor on this unit during operation.

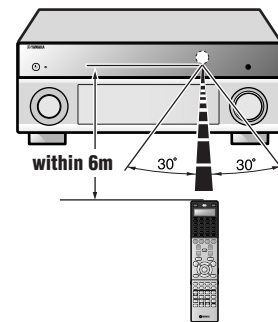

Items necessary for connection

Speakers



E.g.
Front speaker



E.g.
Center speaker



E.g.
Surround speaker, surround back speaker, and presence speaker

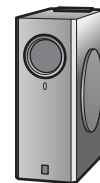

E.g.
Active subwoofer

- Use speakers with an impedance of at least 6 Ω. 4 Ω speakers can also be used as the front speakers. For more information on speaker impedance, refer to page 3.
- If you are using a CRT monitor, we recommend that you use magnetically shielded speakers.
- Prepare at least two front speakers. The priority of the other speakers is as follows:
 - 1 Two surround speakers
 - 2 One center speaker
 - 3 One (or two) surround back speaker (s)/presence speakers

External components



TV



Playback device such as
BD (Blu-ray Disc)/DVD players

Cable

- Cables for connecting external components (may differ depending on the components you are connecting)
- Speaker cables (a quantity to match the number of speakers you are connecting)
- Audio pin cable (for subwoofer)

Connect and install as follows the first time you use this unit.

See the following explanations for the connections for each number.

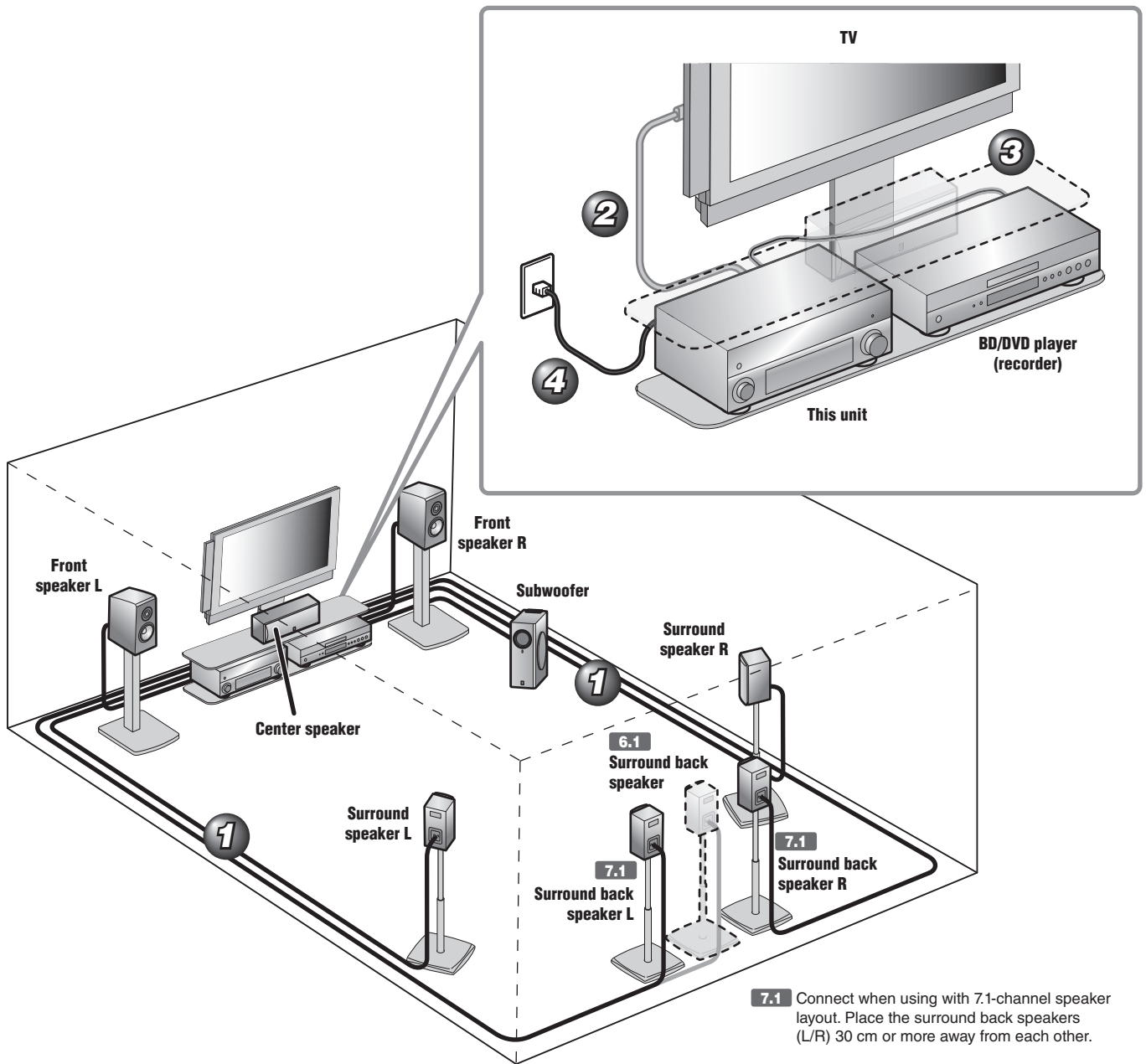

- 1** Connect the speakers
- 2** Connect a TV
- 3** Connect playback devices such as BD/DVD players and recorders
- 4** Connect the power cable
- 5** Set up the speaker parameters automatically (YPAO)

7.1 Connect when using with 7.1-channel speaker layout. Place the surround back speakers (L/R) 30 cm or more away from each other.

6.1 Connect when using with 6.1-channel speaker layout. Place the surround back speaker behind the listening position.

1

Connect the speakers

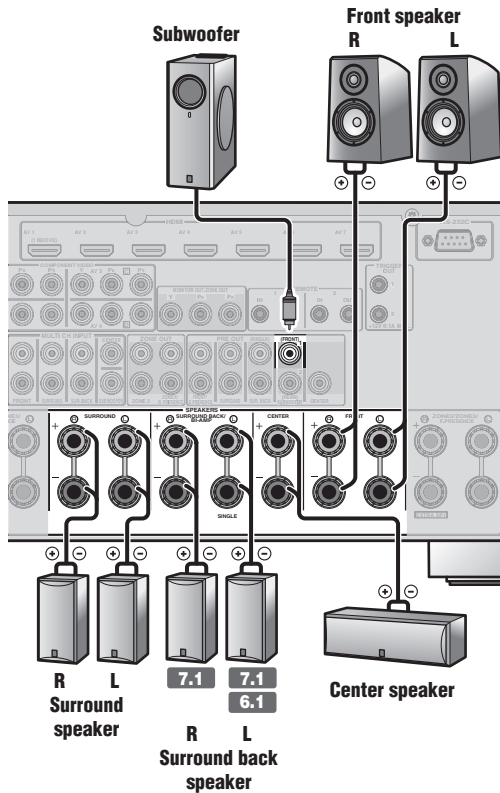

- 7.1** Connect when using with 7.1-channel speaker layout.
- 6.1** Connect when using with 6.1-channel speaker layout.

Caution:

- Remove the power cable of this unit from the power outlet before connecting the speakers.
- Generally speaker cables consist of two parallel insulated cables. One of these cables is a different color, or has a line running along it, to indicate different polarity. Insert the different colored (or lined) cable into the "+" (positive, red) terminal on this unit and the speakers, and the other cable into the "-" (minus, black) terminal.
- Be careful that the core of the speaker cable does not touch anything or come into contact with the metal areas of this unit. This may damage this unit or the speakers. If the speaker cables short circuit, "CHECK SP WIRES!" will appear on the front panel display when this unit is switched on.
- This unit is configured for 8 Ω speakers at the factory setting. When connecting 6 Ω speakers, configure the speaker impedance setting of this unit to 6 Ω. When this unit is configured for 6 Ω speakers, 4 Ω speakers can also be used as the front speakers. For more information on setting the speaker impedance, refer to "Changing speaker impedance" in the Owner's Manual.
- When connecting the presence speakers, refer to "Presence speaker connection" in the Owner's Manual.
- This unit can connect speakers that support Bi-amp connection for front speakers. Refer to "Bi-amp connection" in the Owner's Manual.

Connecting speakers

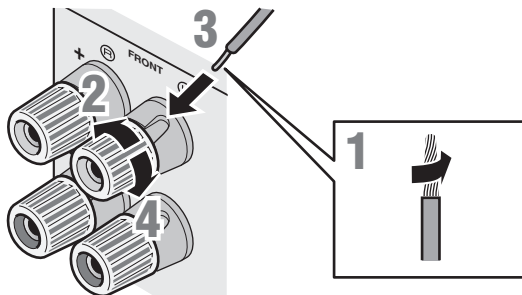

- Remove approximately 10 mm of insulation from the ends of the speaker cables, and twist the bare wires of the cables together firmly so that they will not cause short circuits.
- Loosen the speaker terminals.
- Insert the bare wire of the speaker cable into the gap on the side of the terminal.
- Tighten the terminal.

Connecting the subwoofer

- Connect the subwoofer input jack to the SUBWOOFER 1 jack on this unit with an audio pin cable.

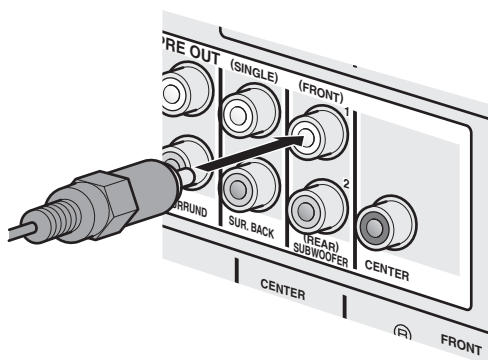

- Set the subwoofer volume as follows.
Volume: Set to approximately half volume (or slightly less than half).
Crossover frequency (if available): Set to maximum.

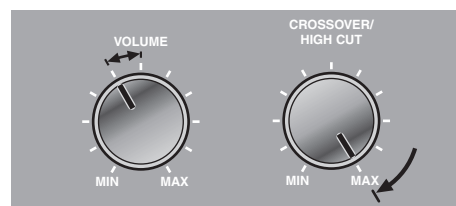

Subwoofer examples

2

Connect a TV

If your TV has multiple inputs, connect with the following priority (A to D).

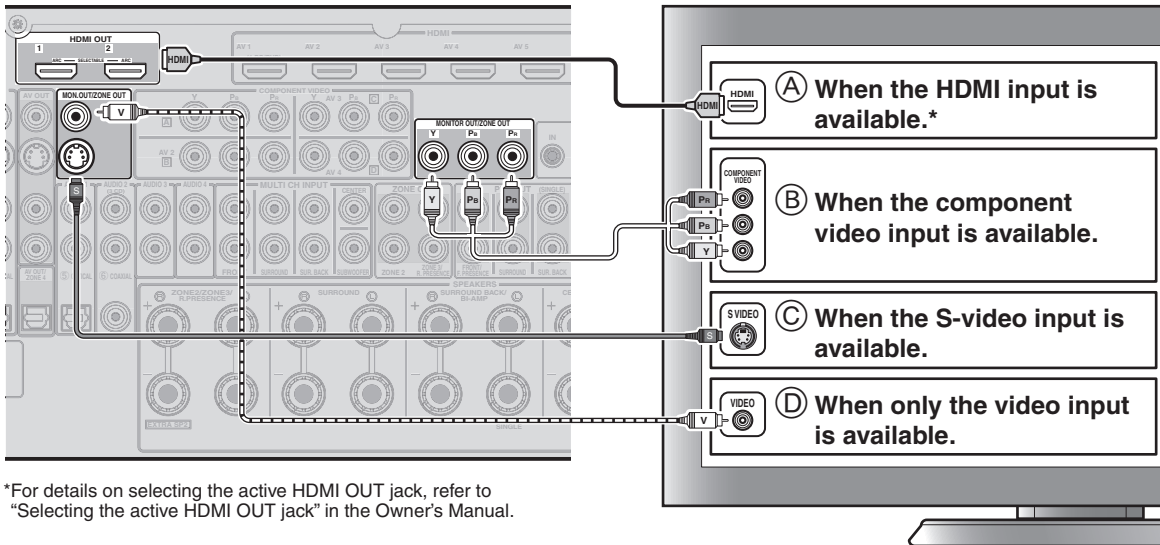

*For details on selecting the active HDMI OUT jack, refer to "Selecting the active HDMI OUT jack" in the Owner's Manual.

When connecting to an HDMI compatible TV

Video signal such as component video, S-video and video received by this unit is converted to HDMI and output to the TV. Just select HDMI input on the TV to view video from any external source connected to this unit.

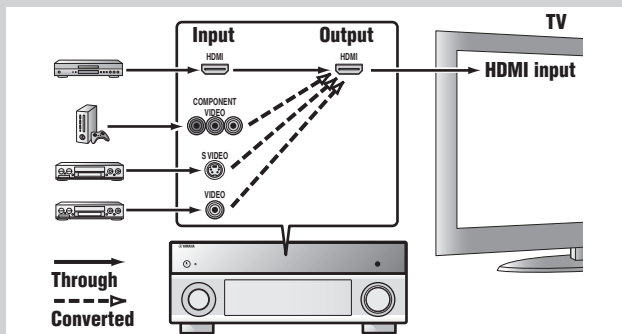

When connecting to a non-HDMI compatible TV

Connect to the TV using the same type of connection that you used to connect to the playback device.

If the playback device and TV are equipped with different types of analog video jacks, this unit will convert the video signals to another type of video signal, according to the type of video input jacks used on the TV.

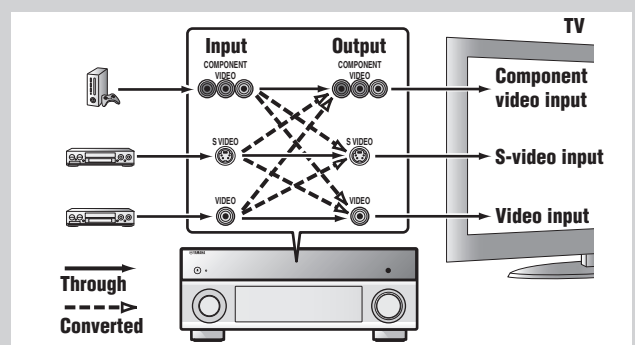

For more information on video signal conversion, refer to "Connecting a TV monitor" in the Owner's Manual.

Listening to TV audio

To play back TV audio on this unit, connect the TV audio output to this unit.

Connect the following input jacks, matching the audio output jacks on your TV. When viewing your TV, select the appropriate input source on this unit.

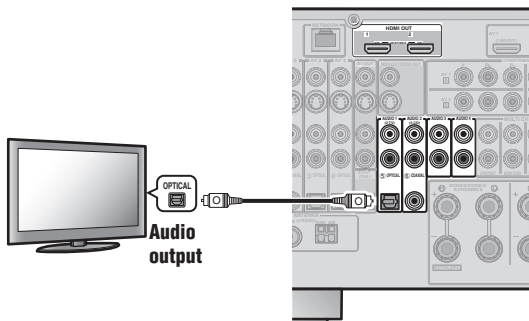

When using a TV that supports the Audio Return Channel function and HDMI Control function

When using an HDMI compatible TV that supports Audio Return Channel functions and / or HDMI Control functions (e.g., Panasonic VIERA Link), you can enjoy the TV sound on this unit.

The audio / video output from the unit to the TV and audio output from the TV to the unit are possible using a single HDMI cable.

The input source is switched automatically to match operations carried out on the TV, and that makes TV sound control easier to use.

For the connections and settings, refer to "Using the HDMI Control function" in the Owner's Manual.

Audio output from TV	Input jack on this unit
Optical digital output	AUDIO1
Coaxial digital output	AUDIO2
Analog output	AUDIO1, AUDIO2, AUDIO3, or AUDIO4
HDMI Audio Return Channel (Described in the right column)	HDMI OUT 1 or HDMI OUT 2

* Connecting to AUDIO1 allows you to playback TV audio just by pressing the **SCENE2** key.

3 Connect playback devices such as BD/DVD players and recorders

If your playback device has multiple audio/video outputs, connect with the following priority (A to D) to enjoy a higher quality sounds and images.

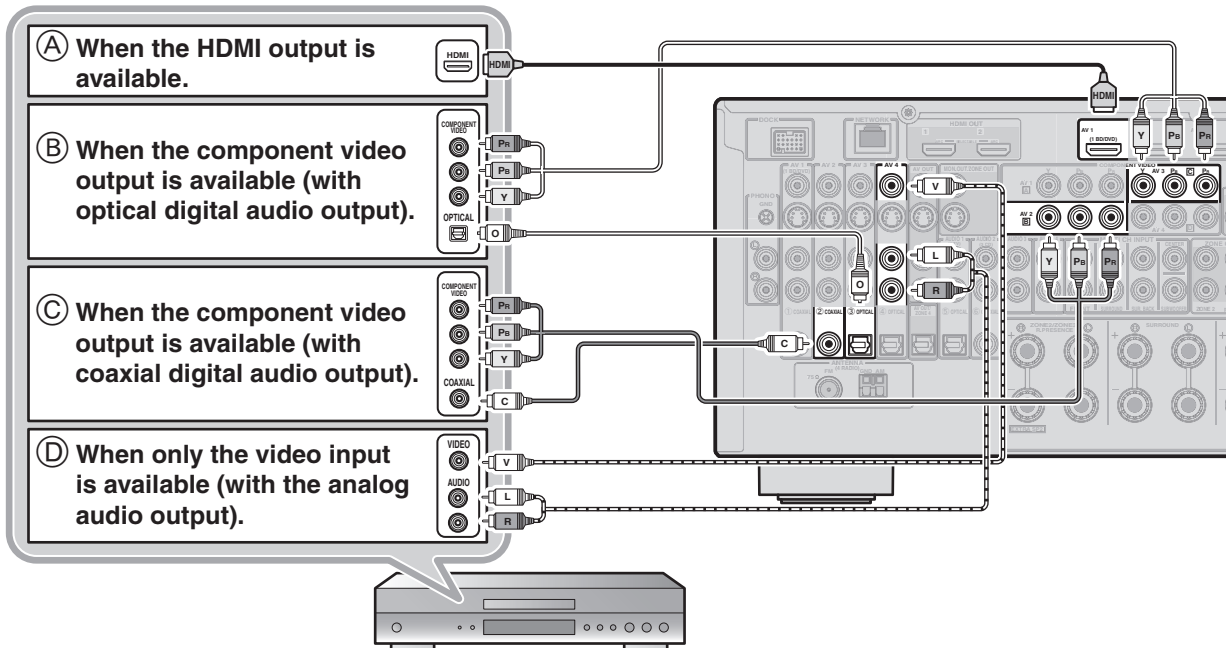

* Refer to "Connecting BD/DVD players and other devices" in Owner's Manual for details on connection other than above illustration.

- When playing back a device, select the corresponding input source to which the jack is connected.
- If necessary, you can connect components that cannot be connected using the above methods, such as devices that output video from component video output jacks and audio from analog output jacks. Refer to "Connecting external components" in the Owner's Manual for details.
- At the default settings, input sources and sound programs are preset on the **SCENE** keys. When a playback device is connected to AV1, pressing the **SCENE1** key selects the AV1 input. When a playback device is connected to AUDIO2, pressing the **SCENE3** selects the AUDIO2 input. The input source and sound program preset on the **SCENE** key can be changed.

Default scene settings

SCENE	Input	Audio Select	HDMI Output	Sound Program	Pure Direct Mode	Tone Control	Adaptive DRC	Enhancer
1 (BD/DVD)	AV1	Auto	OUT1+2	Drama	Auto	Bass: 0.0dB Treble: 0.0dB	On	Off
2 (TV)	AUDIO1	Auto	OUT1+2	STRAIGHT	Auto	Bass: 0.0dB Treble: 0.0dB	On	On
3 (CD)	AUDIO2	Auto	OUT1+2	STRAIGHT	Auto	Bass: 0.0dB Treble: 0.0dB	Off	Off
4 (RADIO)	TUNER	---	OUT1+2	STRAIGHT	Auto	Bass: 0.0dB Treble: 0.0dB	Off	On

The several settings other than ones in the above table can be assigned to the **SCENE** keys. For more information on the SCENE function, refer to "Changing input settings with a single key (SCENE function)" in the Owner's Manual.

4 Connect the power cable

Plug the supplied power cable into the AC inlet after all other connections are complete, then plug the power cable into an AC wall outlet.

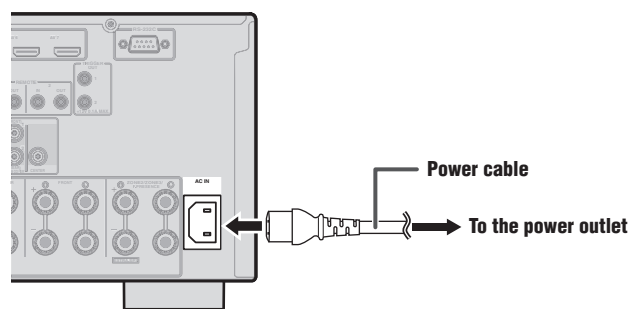

5

Set up the speaker parameters automatically (YPAO)

When all connections are complete, adjust the configuration, sizes, and volume balance of the speakers to provide an optimal sound field. This unit is equipped with a Yamaha Parametric Room Acoustic Optimizer (YPAO) function that adjusts the speaker balance automatically with a simple procedure.

Be aware of the following when using YPAO.

- The amount of time for measurement varies from about two to ten minutes according to settings.
- The test tone is output at high volume. Refrain from using this function at night when it may be a nuisance to others.
- Take care that the test tone does not frighten small children.

YPAO operations can be viewed on the front panel display or TV screen. TV display is used here to explain operation.

1 Check the following before using YPAO.

This unit

- The headphones are removed.

TV

- This unit is connected to the TV correctly.
- The power is turned on.
- The video input to which the video output from this unit has been selected.

Subwoofer

- The power is turned on.
- Volume is set to approximately half, and the cross-over frequency (if present) is set to maximum.

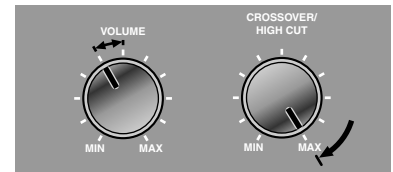

Subwoofer examples

2 Place the supplied YPAO microphone at ear height in your listening position.

- When positioning the microphone, we recommend that you use equipment that allows you to adjust the height (such as a tripod) as a microphone stand. When using a tripod, use the tripod screws to fix the microphone in place.
- Measuring for multiple listening positions is also available. For more information, refer to "Setting up the speaker parameters automatically (YPAO)" in the Owner's Manual.

YPAO microphone

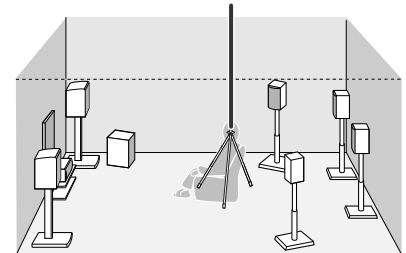

3 Press **RECEIVER** on the remote control to switch this unit on.

4 Connect the YPAO microphone to the YPAO MIC jack on the front panel.

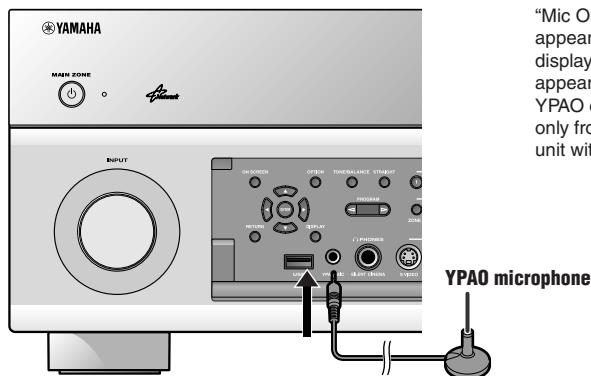

"Mic On View ON SCREEN" appears on the front panel display, and the display at right appears on the TV screen. YPAO can be performed viewing only front panel display on this unit without the TV screen.

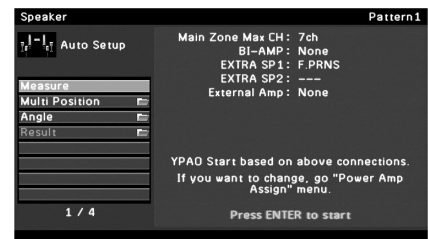

Opening and closing the front panel door

Before step 4, gently press the bottom of the door to open it. Keep the door closed when not using controls or jacks behind the front panel door.

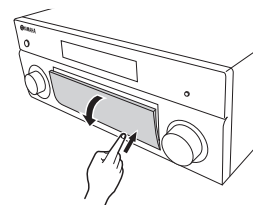

This completes preparation. To achieve more accurate results, take note of the following when measuring acoustics.

- Keep the room as quiet as possible for a few minutes.
- Wait in a corner of the room, or leave it entirely, while acoustics are measured to avoid creating an obstruction between the speakers and the YPAO microphone.

Continues to the next page

- 5** Use the **cursor** Δ/∇ to select the “Measure” and press **ENTER** to start measurement.

When “Multi Position” and/or “Angle” is set to “Yes” (default), the measurement of Multi Position and/or Angle continues. Refer to “Setting up the speaker parameters automatically (YPAO)” for details on “Multi Position” and “Angle” in the Owner’s Manual.

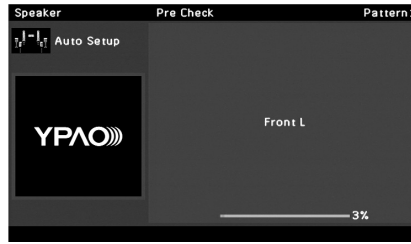

The display at right appears if measurement finishes without any problems.

Result

Displays the results of automatic acoustics measurement. For details, refer to “Reviewing the automatic setup parameters” in the Owner’s Manual.

Save/Exit

Applies the result to the speaker setup and finishes the automatic measurement.

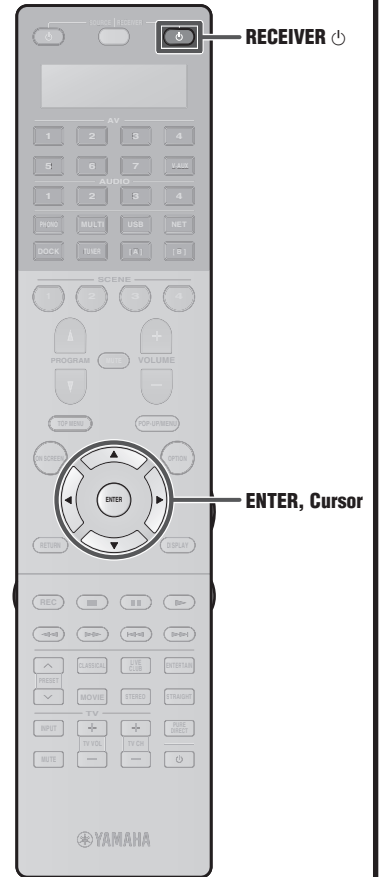

Note

If a problem occurs, an error message or report is displayed either during or after acoustic measurement. Refer to “When an error message is displayed during measurement,” or “When a warning message is displayed after measurement” in the Owner’s Manual to resolve the problem and measure acoustics with YPAO again.

- 6** Use the **cursor** Δ/∇ to select “Save/Exit” and press **ENTER**.

- 7** Use the **cursor** $\triangleleft/\triangleright$ to select “SAVE” and press **ENTER**.

When the display at right appears, the YPAO setup is complete.



- 8** Press **ENTER**.

YPAO is terminated. Disconnect the YPAO microphone.

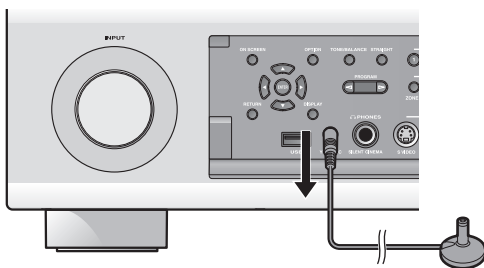

All the preparation is completed. Enjoy the various functions provided by this unit. For details on the operations, refer to the Owner’s Manual.

Basic operations

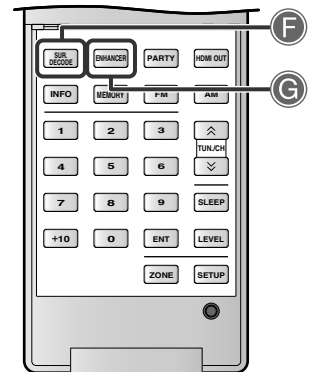
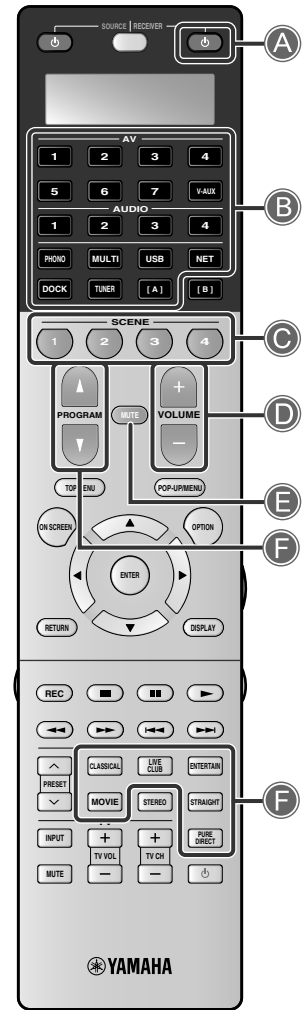
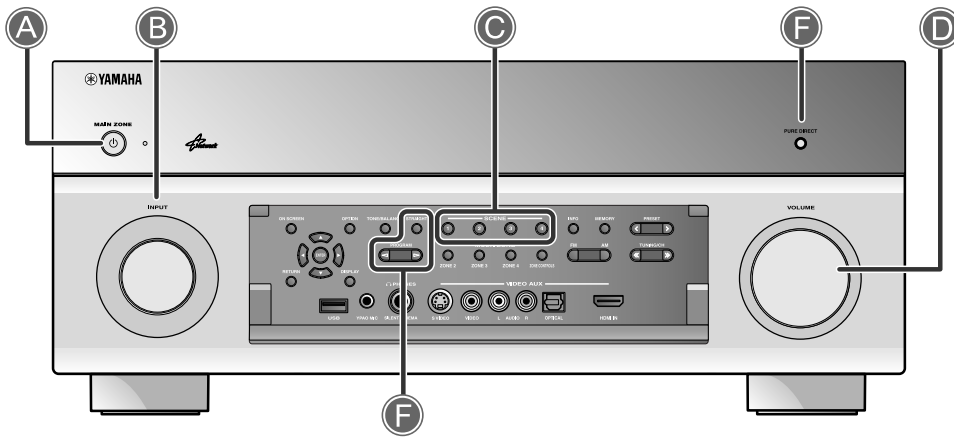

A Switches this unit between on and standby mode

This unit switches between on and standby mode every time you press this key.

B Selects an input source to listen to

The name of the selected input source appears on the front panel display.



C Selects a scene

You can switch the settings such as input sources and sound field programs with a single key. Refer to "Default scene settings" on page 5 for details on the settings assigned to this unit.

D Adjusts the volume level

The current volume level is displayed on the front panel display.



E Mutes the sound

The MUTE indicator blinks while the sound is muted.

F Selects sound field programs and sound decoders

Front panel	Remote control	Description
PROGRAM	CLASSICAL LIVE CLUB	Selects sound field programs optimized for appreciating music.
	ENTERTAIN MOVIE	Selects sound field programs optimized for viewing movies, dramas, and sports.
	SUR DECODE	Selects surround decoders such as Dolby Pro Logic II.
STRAIGHT	STRAIGHT	Switches to Straight decoding mode for stereo/multi-channel playback without using a sound field program.
PURE DIRECT	PURE DIRECT	Switches to Pure Direct Mode for faithful reproduction of audio.

G Turns on Compressed Music Enhancer

Press **ENHANCER** to turn on Compressed Music Enhancer for playback of the compressed music source with better sound quality.

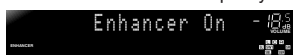

To disable Compressed Music Enhancer, press **ENHANCER** again.

Opening the remote control cover

Hold the tabs on the sides of the remote control with your fingers, and pull the cover to open.

