



PORTATONE

Entertainment Station

# PSR-K1



*Owner's Manual*



# SPECIAL MESSAGE SECTION

This product utilizes batteries or an external power supply (adapter). DO NOT connect this product to any power supply or adapter other than one described in the manual, on the name plate, or specifically recommended by Yamaha.

This product should be used only with the components supplied or; a cart, rack, or stand that is recommended by Yamaha. If a cart, etc., is used, please observe all safety markings and instructions that accompany the accessory product.

## **SPECIFICATIONS SUBJECT TO CHANGE:**

The information contained in this manual is believed to be correct at the time of printing. However, Yamaha reserves the right to change or modify any of the specifications without notice or obligation to update existing units.

This product, either alone or in combination with an amplifier and headphones or speaker/s, may be capable of producing sound levels that could cause permanent hearing loss. DO NOT operate for long periods of time at high volume level or at a level that is uncomfortable. If you experience any hearing loss or ringing in the ears, you should consult an audiologist.

**IMPORTANT:** The louder the sound, the shorter the time period before damage occurs.

## **NOTICE:**

Service charges incurred due to a lack of knowledge relating to how a function or effect works (when the unit is operating as designed) are not covered by the manufacturer's warranty, and are therefore the owners responsibility. Please study this manual carefully and consult your dealer before requesting service.

## **ENVIRONMENTAL ISSUES:**

Yamaha strives to produce products that are both user safe and environmentally friendly. We sincerely believe that our products and the production methods used to produce them, meet these goals. In keeping with both the letter and the spirit of the law, we want you to be aware of the following:

### **Battery Notice:**

This product MAY contain a small non-rechargeable battery which (if applicable) is soldered in place. The average life span of this type of battery is approximately five years. When replacement becomes necessary, contact a qualified service representative to perform the replacement.

This product may also use "household" type batteries. Some of these may be rechargeable. Make sure that the battery being charged is a rechargeable type and that the charger is intended for the battery being charged.

When installing batteries, do not mix batteries with new, or with batteries of a different type. Batteries MUST be installed correctly. Mismatches or incorrect installation may result in overheating and battery case rupture.

### **Warning:**

Do not attempt to disassemble, or incinerate any battery. Keep all batteries away from children. Dispose of used batteries promptly and as regulated by the laws in your area. Note: Check with any retailer of household type batteries in your area for battery disposal information.

### **Disposal Notice:**

Should this product become damaged beyond repair, or for some reason its useful life is considered to be at an end, please observe all local, state, and federal regulations that relate to the disposal of products that contain lead, batteries, plastics, etc. If your dealer is unable to assist you, please contact Yamaha directly.

### **NAME PLATE LOCATION:**

The name plate is located on the bottom of the product. The model number, serial number, power requirements, etc., are located on this plate. You should record the model number, serial number, and the date of purchase in the spaces provided below and retain this manual as a permanent record of your purchase.

**Model**

---

**Serial No.**

---

**Purchase Date**

---

# PLEASE KEEP THIS MANUAL

92-BP (bottom)

## FCC INFORMATION (U.S.A.)

### 1. IMPORTANT NOTICE: DO NOT MODIFY THIS UNIT!

This product, when installed as indicated in the instructions contained in this manual, meets FCC requirements. Modifications not expressly approved by Yamaha may void your authority, granted by the FCC, to use the product.

**2. IMPORTANT:** When connecting this product to accessories and/or another product use only high quality shielded cables. Cable/s supplied with this product **MUST** be used. Follow all installation instructions. Failure to follow instructions could void your FCC authorization to use this product in the USA.

**3. NOTE:** This product has been tested and found to comply with the requirements listed in FCC Regulations, Part 15 for Class "B" digital devices. Compliance with these requirements provides a reasonable level of assurance that your use of this product in a residential environment will not result in harmful interference with other electronic devices. This equipment generates/uses radio frequencies and, if not installed and used according to the instructions found in the users manual, may cause interference harmful to the operation of other electronic devices. Compliance

with FCC regulations does not guarantee that interference will not occur in all installations. If this product is found to be the source of interference, which can be determined by turning the unit "OFF" and "ON", please try to eliminate the problem by using one of the following measures:

Relocate either this product or the device that is being affected by the interference.

Utilize power outlets that are on different branch (circuit breaker or fuse) circuits or install AC line filter/s.

In the case of radio or TV interference, relocate/reorient the antenna. If the antenna lead-in is 300 ohm ribbon lead, change the lead-in to co-axial type cable.

If these corrective measures do not produce satisfactory results, please contact the local retailer authorized to distribute this type of product. If you can not locate the appropriate retailer, please contact Yamaha Corporation of America, Electronic Service Division, 6600 Orangethorpe Ave, Buena Park, CA90620

The above statements apply **ONLY** to those products distributed by Yamaha Corporation of America or its subsidiaries.

\* This applies only to products distributed by YAMAHA CORPORATION OF AMERICA.

(class B)

### OBSERVERA!

Apparaten kopplas inte ur växelströmskällan (nätet) så länge som den är ansluten till vägguttaget, även om själva apparaten har stängts av.

**ADVARSEL:** Netspændingen til dette apparat er IKKE afbrudt, så længe netledningen sidder i en stikkontakt, som er tændt — også selvom der er slukket på apparatets afbryder.

**VAROITUS:** Laitteen toisiopiiriin kytketty käyttökytin ei irroita koko laitetta verkosta.

(standby)

### Entsorgung leerer Batterien (nur innerhalb Deutschlands)

Leisten Sie einen Beitrag zum Umweltschutz. Verbrauchte Batterien oder Akkumulatoren dürfen nicht in den Hausmüll. Sie können bei einer Sammelstelle für Altbatterien bzw. Sondermüll abgegeben werden. Informieren Sie sich bei Ihrer Kommune.

(battery)

*Congratulations and thank you for purchasing the  
Yamaha Entertainment Station PSR-K1!*

*Please read this owner's manual carefully before using the instrument,  
in order to take full advantage of its various features.  
Make sure to keep this manual in a safe and handy place even after you finish reading,  
and refer to it often when you need to better understand an operation or function.*

## PRECAUTIONS

### PLEASE READ CAREFULLY BEFORE PROCEEDING

\* Please keep this manual in a safe place for future reference.



### WARNING

Always follow the basic precautions listed below to avoid the possibility of serious injury or even death from electrical shock, short-circuiting, damages, fire or other hazards. These precautions include, but are not limited to, the following:

#### Power supply/AC power adaptor

- Only use the voltage specified as correct for the instrument. The required voltage is printed on the name plate of the instrument.
- Use the specified adaptor (PA-5D or an equivalent recommended by Yamaha) only. Using the wrong adaptor can result in damage to the instrument or overheating.
- Check the electric plug periodically and remove any dirt or dust which may have accumulated on it.
- Do not place the AC adaptor cord near heat sources such as heaters or radiators, and do not excessively bend or otherwise damage the cord, place heavy objects on it, or place it in a position where anyone could walk on, trip over, or roll anything over it.

#### Do not open

- Do not open the instrument or attempt to disassemble the internal parts or modify them in any way. The instrument contains no user-serviceable parts. If it should appear to be malfunctioning, discontinue use immediately and have it inspected by qualified Yamaha service personnel.

#### Water warning

- Do not expose the instrument to rain, use it near water or in damp or wet conditions, or place containers on it containing liquids which might spill into any openings.
- Never insert or remove an electric plug with wet hands.

#### Fire warning

- Do not put burning items, such as candles, on the unit.  
A burning item may fall over and cause a fire.

#### If you notice any abnormality

- If the AC adaptor cord or plug becomes frayed or damaged, or if there is a sudden loss of sound during use of the instrument, or if any unusual smells or smoke should appear to be caused by it, immediately turn off the power switch, disconnect the adaptor plug from the outlet, and have the instrument inspected by qualified Yamaha service personnel.



### CAUTION

Always follow the basic precautions listed below to avoid the possibility of physical injury to you or others, or damage to the instrument or other property. These precautions include, but are not limited to, the following:

#### Power supply/AC power adaptor

- When removing the electric plug from the instrument or an outlet, always hold the plug itself and not the cord.
- Unplug the AC power adaptor when not using the instrument, or during electrical storms.
- Do not connect the instrument to an electrical outlet using a multiple-connector. Doing so can result in lower sound quality, or possibly cause overheating in the outlet.

#### Battery

- Use only manganese or alkaline batteries for this instrument. Other types of batteries (including rechargeable batteries) may have sudden drops of power when battery power becomes low, possibly resulting in loss of data in the SmartMedia™ card and the need to re-format the card.
- Always make sure all batteries are inserted in conformity with the +/- polarity markings. Failure to do so might result in overheating, fire, or battery fluid leakage.

- Always replace all batteries at the same time. Do not use new batteries together with old ones. Also, do not mix battery types, such as alkaline batteries with manganese batteries, or batteries from different makers, or different types of batteries from the same maker, since this can cause overheating, fire, or battery fluid leakage.
- Do not dispose of batteries in fire.
- Do not attempt to recharge batteries that are not intended to be charged.
- When the batteries run out, or if the instrument is not to be used for a long time, remove the batteries from the instrument to prevent possible leakage of the battery fluid.
- Keep batteries away from children.
- If the batteries do leak, avoid contact with the leaked fluid. If the battery fluid should come in contact with your eyes, mouth, or skin, wash immediately with water and consult a doctor. Battery fluid is corrosive and may possibly cause loss of sight or chemical burns.

### Location

- Do not expose the instrument to excessive dust or vibrations, or extreme cold or heat (such as in direct sunlight, near a heater, or in a car during the day) to prevent the possibility of panel disfiguration or damage to the internal components.
- Do not use the instrument in the vicinity of a TV, radio, stereo equipment, mobile phone, or other electric devices. Otherwise, the instrument, TV, or radio may generate noise.
- Do not place the instrument in an unstable position where it might accidentally fall over.
- Before moving the instrument, remove all connected adaptor and other cables.
- Use only the stand specified for the instrument. When attaching the stand or rack, use the provided screws only. Failure to do so could cause damage to the internal components or result in the instrument falling over.

### Connections

- Before connecting the instrument to other electronic components, turn off the power for all components. Before turning the power on or off for all components, set all volume levels to minimum. Also, be sure to set the volumes of all components at their minimum levels and gradually raise the volume controls while playing the instrument to set the desired listening level.

### Maintenance

- When cleaning the instrument, use a soft, dry cloth. Do not use paint thinners, solvents, cleaning fluids, or chemical-impregnated wiping cloths.

### Handling caution

- Do not insert a finger or hand in any gaps on the instrument.
- Never insert or drop paper, metallic, or other objects into the gaps on the panel or keyboard. If this happens, turn off the power immediately and unplug the power cord from the AC outlet. Then have the instrument inspected by qualified Yamaha service personnel.
- Do not place vinyl, plastic or rubber objects on the instrument, since this might discolor the panel or keyboard.
- Do not rest your weight on, or place heavy objects on the instrument, and do not use excessive force on the buttons, switches or connectors.
- Do not operate the instrument for a long period of time at a high or uncomfortable volume level, since this can cause permanent hearing loss. If you experience any hearing loss or ringing in the ears, consult a physician.
- Make sure to keep removable parts of the instrument (such as the microphone holder cap and the microphone holder screw) away from small children.

### Saving data

#### Saving and backing up your data

- Internal data is lost when you turn off the power to the instrument. Save the data to a SmartMedia Card (Memory Card) (see page 84).

#### Backing up the SmartMedia™ Card (Memory Card)

- To protect against data loss through media damage, we recommend that you save your important data onto two SmartMedia Cards (Memory Cards).

Yamaha cannot be held responsible for damage caused by improper use or modifications to the instrument, or data that is lost or destroyed.

Always turn the power off when the instrument is not in use.

When using a power adaptor, even when the power switch is in the "STANDBY" position, electricity is still flowing to the instrument at the minimum level. When you are not using the instrument for a long time, make sure you unplug the AC power adaptor from the wall AC outlet.

Make sure to discard used batteries according to local regulations.

The illustrations and LCD screens as shown in this owner's manual are for instructional purposes only, and may be different from the ones on your instrument.

- The bitmap fonts used in this instrument have been provided by and are the property of Ricoh Co., Ltd.
- Apple and Macintosh are trademarks of Apple Computer, Inc., registered in the U.S. and other countries.
- Windows is the registered trademark of Microsoft® Corporation.
- All other trademarks are the property of their respective holders.

# Contents

Copyright Notice .....	7
Panel logos .....	7
Included accessories .....	8
Display naming conventions .....	8
Main features of the PSR-K1 .....	9
<b>Setting Up</b> .....	<b>10</b>
Power Requirements .....	10
Inserting the SmartMedia card .....	12
Setting up the included microphone .....	12
Connecting headphones (PHONES jack) .....	14
Connecting to external audio devices (OUTPUT R, L terminal) .....	14
Connecting a foot switch (SUSTAIN jack) .....	14
Connecting to a computer (USB terminal) .....	14
Turn on the power .....	15
<b>Panel Controls and Terminals</b> .....	<b>16</b>
Front Panel .....	16
Rear Panel .....	16
<b>Quick Guide</b>	
<b>Play like a pro!</b> .....	<b>18</b>
Playing the Demo Song .....	18
Selecting and playing with other songs .....	19
Performance assistant technology — other convenient controls and features .....	20
<b>Sing along—with the Karaoke features!</b> .....	<b>22</b>
Select a song and sing .....	22
Karaoke — other convenient controls and features .....	24
Sing along with the “electronic” sheet music! .....	25
<b>Play a variety of different instrument sounds</b> .....	<b>26</b>
Selecting an instrument sound and playing it .....	26
Play a drum kit from the keyboard! .....	27
Other convenient functions .....	28
<b>Try out the Style</b> .....	<b>30</b>
Select a style and play .....	30
Other useful functions .....	32
<b>Improve your playing skills — with Song Lesson!</b> .....	<b>34</b>
Start out with Lesson 1 — practicing the timing .....	34
Lesson 2 — playing the correct notes .....	36
Lesson 3 — practicing with only one hand .....	36
Lesson 4 — playing with both hands .....	37
<b>Basic operations and the LCD display</b> .....	<b>38</b>
<b>Playing Voices — Related Functions</b> .....	<b>40</b>
Playing the grand piano settings (Portable Grand) .....	40
Selecting and playing a voice .....	40
Playing two different voices together (Dual) .....	40
Playing different voices with your left and right hands (Split) .....	41
Using the Metronome .....	42
Dynamically change the volume by your playing strength (Touch) .....	43
Adding harmony sounds (Harmony) .....	44
Applying the Reverb effect .....	45
Applying the Chorus effect .....	45
<b>Style Functions</b> .....	<b>47</b>
Sounding only the percussion .....	47
Stop Accompaniment function .....	47
Setting the Style Volume .....	47
Using external Style Files .....	47
Playing accompaniment chords .....	48
Dictionary .....	50

<b>Memorizing your panel settings</b> .....	<b>52</b>
Creating (saving) Registration Memory settings .....	52
<b>Song playback functions</b> .....	<b>54</b>
Song types .....	54
Displaying Lyrics .....	54
Displaying Notation (sheet music) .....	54
Song Lesson .....	55
Setting the song volume .....	55
Changing the melody voice of the song .....	55
Listen repeatedly to a section of the song .....	56
Song track structure .....	56
<b>Making your own song arrangements (Easy Song Arranger)</b> .....	<b>57</b>
About Easy Song Arranger .....	57
Using Easy Song Arranger .....	57
<b>Recording your performances</b> .....	<b>59</b>
Recording .....	59
Recording a song .....	59
Deleting a User song (Song Clear) .....	61
Deleting a single track of a User song (Track Clear) .....	61
<b>SmartMedia card file operations</b> .....	<b>62</b>
About the SmartMedia card file operations .....	62
Formatting a SmartMedia card .....	62
File Load .....	63
Saving User data files .....	63
Save the User song as a Standard MIDI File .....	64
Deleting User data files .....	65
<b>About MIDI</b> .....	<b>66</b>
What Is MIDI? .....	66
Connecting to a computer .....	67
MIDI settings .....	67
MIDI settings for computer connections (PC Mode) .....	69
Remote control of MIDI devices .....	69
Downloading song data .....	70
<b>Accessory CD-ROM Installation Guide</b> .....	<b>71</b>
Contents of CD-ROM .....	71
CD-ROM Installation Procedure .....	71
Minimum System Requirements .....	72
For Windows Users .....	72
For Macintosh Users .....	74
<b>Function settings</b> .....	<b>77</b>
Calling up the setting pages .....	77
<b>Appendix</b>	
<b>Troubleshooting</b> .....	<b>80</b>
<b>Messages</b> .....	<b>82</b>
<b>Saving backup data to SmartMedia card</b> .....	<b>84</b>
<b>Specifications</b> .....	<b>85</b>
<b>Voice List</b> .....	<b>86</b>
Maximum Polyphony .....	86
<b>Drum Kit List</b> .....	<b>90</b>
<b>Style List</b> .....	<b>92</b>
<b>Song List</b> .....	<b>93</b>
<b>MIDI Implementation Chart</b> .....	<b>94</b>
Effect map .....	95
<b>Index</b> .....	<b>96</b>

## Copyright Notice

- ① Three of the internal songs (or compositions) included in this keyboard are as follows:

### **A Hard Day's Night**

Words and Music by John Lennon and Paul McCartney

Copyright© 1964 Sony/ATV Songs LLC

Copyright Renewed

All Rights Administered by Sony/ATV Music Publishing, 8 Music Square West, Nashville, TN37203

International Copyright Secured All Rights Reserved

### **Can't Help Falling In Love**

Words and Music by George David Weiss, Hugo Peretti and Luigi Creatore

Copyright© 1961 by Gladys Music, Inc.

Copyright Renewed and Assigned to Gladys Music

All Rights Administered by Cherry Lane Music Publishing Company, Inc. and Chrysalis Music

International Copyright Secured All Rights Reserved

### **Stella By Starlight**

from the Paramount Picture THE UNINVITED

Words by Ned Washington

Music by Victor Young

Copyright© 1946 (Renewed 1973, 1974) by Famous Music Corporation

International Copyright Secured All Rights Reserved

- ② Two of the internal songs (or compositions) included in this keyboard are as follows:

Composition : An Englishman In New York

Composer : Sumner 0590545

Copyright Owner : G M SUMNER LTD

Composition : Against All Odds

Composer : Collins 0007403

Copyright Owner : EMI MUSIC PUBLISHING LTD  
/ HIT & RUN MUSIC LTD

All Rights Reserved, Unauthorized copying, public performance and broadcasting are strictly prohibited regarding the above five internal songs.

**COPYRIGHT NOTICE** This product incorporates and bundles computer programs and contents in which Yamaha owns copyrights or with respect to which it has license to use others' copyrights. Such copyrighted materials include, without limitation, all computer software, styles files, MIDI files, WAVE data and sound recordings. Any unauthorized use of such programs and contents outside of personal use is not permitted under relevant laws. Any violation of copyright has legal consequences. **DON'T MAKE, DISTRIBUTE OR USE ILLEGAL COPIES.**

**Copying of the commercially available software is strictly prohibited except for your personal use.**

## Panel logos



### **GM System Level 1**

"GM System Level 1" is an addition to the MIDI standard which ensures that any GM-compatible music data can be accurately played by any GM-compatible tone generator, regardless of manufacturer. The GM mark is affixed to all software and hardware products that support GM System Level.



### **XGlite**

As its name implies, "XGlite" is a simplified version of Yamaha's high-quality XG tone generation format. Naturally, you can play back any XG song data using an XGlite tone generator. However, keep in mind that some songs may play back differently compared to the original data, due to the reduced set of control parameters and effects.



### **USB**

USB is an abbreviation for Universal Serial Bus. It is a serial interface for connecting computers with peripheral devices. Advantages of USB include its speed, convenience and wide use, as well as its "hot swapping" capability, which allows connection/disconnection while the power to the computer is on.



### **XF**

The Yamaha XF format enhances the SMF (Standard MIDI File) standard with greater functionality and open-ended expandability for the future. The instrument is capable of displaying lyrics when an XF file containing lyric data is played.

## Included accessories

The PSR-K1 package includes the following items. Please check that you have them all.

- Music rest
- Microphone holder cap (spare)
- SmartMedia™ card (Memory card)
- Microphone
- Accessory CD-ROM
- Owner's Manual (this book)

\* SmartMedia is a trademark of Toshiba Corporation

### ● About the included CD-ROM

The included CD-ROM features some utility software programs for use with the instrument. These include Song Filer, which allows you to transmit data from a computer to a SmartMedia card inserted in your PSR-K1, and the USB driver, which enables data communication to the computer via USB. For details, refer to the Accessory CD-ROM Installation Guide (page 71) and the online documentation (PDF files) of each program.

#### **CAUTION**

- *Never attempt to play back the included CD-ROM on an audio CD player. Doing so may result in damage to your hearing as well as to your CD player/audio speakers.*

### ● About the included SmartMedia card

A blank SmartMedia card is included with this instrument. Use this card for saving your own data such as User songs (songs #101 – 105), a User style (style #136), Registration Memory settings (banks #1 – 8), and panel settings. This data which temporarily resides in the internal memory of the PSR-K1 can be saved to a SmartMedia card with the following methods.

- **Hold down the [FUNCTION] button for longer than one second:**  
This operation saves the Registration Memory settings and panel settings to the SmartMedia card as a single specified file named “PSR-K1.ENV.” For details, see page 84.
- **Use the FILE CONTROL function:**  
This operation saves the User songs (songs #101 – 105), a User style (style #136), and Registration Memory settings (banks #1 – 8) as a single file with a name you specify. For details, see page 63.

Please keep in mind that only the Registration Memory data will be saved to the file named “PSR-K1.ENV” on the SmartMedia automatically when memorizing your panel settings to any of the Registration Memory buttons (page 53).

#### **CAUTION**

- *All data residing in the internal memory of the PSR-K1 described above will be lost when turning the power off. Because of this, make sure to insert a SmartMedia card to the CARD slot on the rear panel before turning the power on (page 12) and use the card to save your important data.*

## Display naming conventions

- The major display categories (titles in the bar at the top of each display) are printed in capital letters—for example, MAIN display, FUNCTION display, FILE CONTROL display, etc.
- The FUNCTION display contains forty separate pages (indicated in the black bar in the middle of the display). In the manual, these are described as “pages.” For example, a reference to the Tuning page (below) may say, “in the Tuning page of the FUNCTION display.”

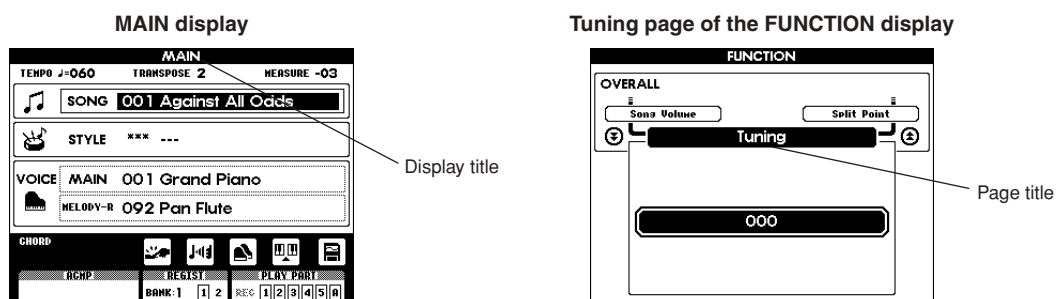



## Main features of the PSR-K1

The PSR-K1 is much more than just a keyboard—it provides a wealth of advanced, convenient performance features that make it possible for anyone to easily perform and sing along with. As its name says, it truly is an Entertainment Station!

### ■ Performance assistant technology ..... page 18

Play back a song and play the keyboard along with it—the song sounds perfect, even if you play the wrong notes! Performance assistant automatically assigns the “right” notes to the keys, and automatically changes with the progression of the song, so that whatever you play sounds professional—even if you play with the plans of your hands!

### ■ Sing along Karaoke-style with the Lyric Display ..... page 22

Lyrics to the song can be shown in the large LCD, and the words are even highlighted one-by-one as the song plays. Use the included microphone, and you’ve got an all-in-one instrument for singing and performing with. Naturally, you can apply echo to your voice and freely change the song tempo.

\* For lyrics to be displayed, the song must contain lyric data.

### ■ Easy performance with the built-in music notation display ..... page 25

Simply play back a selected song, and the written notes are automatically displayed, with a moving marker showing you the position as the song plays. This makes it easier than ever to read music. Plus, for songs containing chord/lyric data, the chords and lyrics are displayed along with the notes—letting you read the music, play and sing all at the same time.

\* For lyrics and chords to be displayed, the song must contain the appropriate data.

### ■ Create your own song library on SmartMedia cards ..... page 62

This instrument uses SmartMedia cards for storing data—meaning you can save all your original songs and important panel settings to a convenient card. SmartMedia cards are also ideal for use with your computer, letting you easily download and save songs from the Internet (using the included Song Filer software) and play them on the instrument.

### ■ Exceptionally easy connection to computer ..... page 67

With just a single USB cable, you easily and instantly can use the instrument with your computer—and transmit performance information and operation data (in MIDI format) between the two devices. (Cable not included.)

### ■ Learning music is fun— with Lesson features and Chord Dictionary ..... pages 34, 50

The Lesson features make practicing songs enjoyable—whatever the music style. Practice each hand separately in three successive steps along with the accompaniment, then move on to mastering the piece with both hands. The instrument even tells you how well you did each lesson. What’s more, there’s a special Chord Dictionary that teaches you chords and shows you how to play them.

### ■ Custom arrange your songs ..... page 57

With the new and exciting Easy Song Arranger feature, you can easily change the feel of a song by applying your favorite accompaniment styles—turning a ballad into a hip hop tune, or giving an R&B song a reggae feel!

### ■ Exceptionally realistic, high-quality sound ..... page 26

Enjoy your performance even more with the authentic, natural-sounding instrument voices—created with the latest AWM (Advanced Wave Memory) technology. Plus, you can hear these dynamic voices with all their power and impact with the built-in two-way speaker system and an enhanced low-end with the Bass Boost feature.

### ■ Touch Response ..... page 43

With three different types of sensitivity, this feature gives you maximum expressive control over the level of the voices by your playing strength, letting you perform your music with all its subtle nuances.



# Setting Up

Make sure to do the following operations **BEFORE** turning on the power.

## Power Requirements

Although the instrument will run either from an optional AC adaptor or batteries, Yamaha recommends use of an AC adaptor whenever possible. An AC adaptor is more environmentally friendly than batteries and does not deplete resources.

### ■ Using an AC Power Adaptor

- 1 Make sure that the [STANDBY/ON] switch of the instrument is set to STANDBY.

#### **⚠ WARNING**

- Use **ONLY** a Yamaha PA-5D AC Power Adaptor (or other adaptor specifically recommended by Yamaha) to power your instrument from the AC mains. The use of other adaptors may result in irreparable damage to both the adaptor and the instrument.

- 2 Connect the AC adaptor (PA-5D, or other adaptor specifically recommended by Yamaha) to the power supply jack.
- 3 Plug the AC adaptor into an AC outlet.

#### **⚠ CAUTION**

- Unplug the AC Power Adaptor when not using the instrument, or during electrical storms.

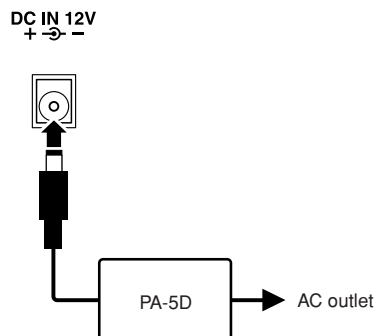

### ■ Using Batteries

- 1 Open the battery compartment cover located on the instrument's bottom panel.
- 2 Insert the six new batteries, being careful to follow the polarity markings on the inside of the compartment.
- 3 Replace the compartment cover, making sure that it locks firmly in place.

#### **NOTE**

- Connecting the AC power adaptor automatically supplies power from the adaptor and overrides battery power, even when batteries are installed.

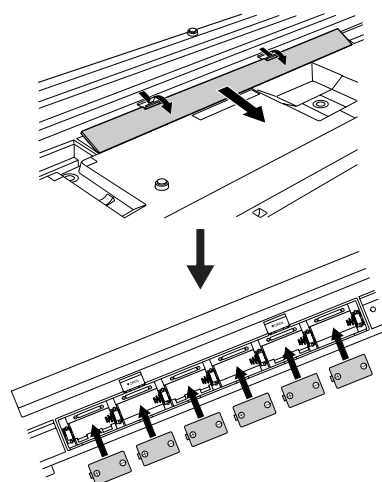

For battery operation the instrument requires six 1.5V “D” size, R20P (LR20) or equivalent batteries. (Alkaline batteries are recommended.) When battery power becomes too low for proper operation, a “LOW BATTERY!!” message flashes in the upper right of the display. As soon as this message appears, make sure to replace all batteries, following the precautions listed below. If necessary, also make sure to save all important User data (see pages 84 and 63), since all User songs and custom panel settings are lost when the batteries are removed.

#### **⚠ CAUTION**

- Make sure to install the batteries in the same direction, maintaining the correct polarity (as shown). Incorrect battery installation may result in heat, fire and/or leaking of corrosive chemicals.
- When the batteries run down, replace them with a complete set of six new batteries. NEVER mix old and new batteries. Do not use different kinds of batteries (e.g. alkaline and manganese) at the same time.
- If the instrument is not to be in use for a long time, remove the batteries from it, in order to prevent possible fluid leakage from the battery.
- Keep in mind that when battery power becomes low, the instrument sounds may revert to their initial settings and the User song data and panel settings may be lost, especially if you play the instrument in this condition at a high volume. If you intend on using batteries, make sure to save your data regularly and often to a SmartMedia card.

## ■ Using SmartMedia™ cards (memory cards)

Be sure to handle SmartMedia cards with care. Follow the important precautions below.

### ● Compatible SmartMedia card Type

This instrument uses SmartMedia™ (3.3V) memory cards. 5V type SmartMedia cards are not compatible with this instrument.

\* SmartMedia is a trademark of Toshiba Corporation.

### ● Memory Capacity

There are five types of SmartMedia cards: 8MB/16MB/32MB/64MB/128MB. If you wish to use capacities of 32MB or more, keep in mind that only SmartMedia cards conforming to SSFDC standards (bearing the SmartMedia™ logo) can be used.

### ● Inserting/Removing SmartMedia cards

#### **Inserting a SmartMedia card**

With the gold-plated contact side facing down, insert the SmartMedia card firmly but carefully into the card slot, as far as it will go. Be careful not to insert the card upside down or back side in. Also, do not insert anything else into the slot, other than a proper SmartMedia card.

#### **Removing a SmartMedia card**

Before removing the SmartMedia card, be sure to confirm that the SmartMedia card is not in use, or it is not being accessed by the instrument. Then pull the SmartMedia card out slowly by hand. If the SmartMedia card is being accessed\*, a message indicating that it is in use appears on the instrument's display.

\* This includes all save, load, format, delete and create directory operations for the SmartMedia card. Also, be aware that the instrument will automatically access the SmartMedia card to check the media type when it is inserted while the instrument is turned on.

#### **⚠ CAUTION**

- *Never attempt to remove the SmartMedia card or turn the power off during accessing. Doing so can damage the data on the instrument/SmartMedia card and possibly the SmartMedia card itself.*

### ● Formatting SmartMedia cards

Before using a SmartMedia card with your instrument it must first be formatted. (However, do NOT format the included SmartMedia card; this has already been formatted for use. Formatting it will delete all data on it.) Once it is formatted all data on it will be erased. Make sure that no important data is contained on the card beforehand.

#### **NOTE**

- *The SmartMedia cards formatted with this instrument may become unusable with other instruments or devices.*

### ● About the SmartMedia cards

#### **Handle SmartMedia cards with care!**

- SmartMedia cards are very sensitive and can be damaged by static electricity. Before handling a SmartMedia card, make sure to discharge any static electricity in your body by touching something made of metal, such as a door knob or aluminum blinds.
- Be sure to remove the SmartMedia card from the card slot when it is not in use for a long time.
- Do not expose the SmartMedia card to direct sunlight, extremely high or low temperatures, or excessive humidity, dust or liquids.
- Do not place heavy objects on a SmartMedia card or bend or apply pressure to the SmartMedia card in any way.
- Never touch the gold-plated contact with your fingers or let it come in contact with any other metallic or hard surface.
- Do not expose the SmartMedia card to magnetic fields, such as those produced by televisions, speakers, motors, etc., since magnetic fields can partially or completely erase data on the SmartMedia card, rendering it unreadable.
- Do not attach anything other than the provided labels to a SmartMedia card. Also make sure that labels are attached only in the proper location.

#### **Protecting your data (write-protect)**

To prevent important data from being inadvertently erased, apply the write-protect seal (provided with the SmartMedia card) to the circle spot indicated on the card. If you are saving data to the card, make sure to remove write-protect seal. Do not reuse a seal that has been removed; it may not stick properly to the card and could come off in the slot.

### ● Data Backup

For maximum data security Yamaha recommends that you keep two copies of important data on separate SmartMedia cards. This gives you a backup if one SmartMedia card is lost or damaged.

#### **⚠ CAUTION**

- *Keep in mind that accidental power interruptions while the SmartMedia card is being accessed can result in damage and irrecoverable loss of data. For this reason, you should regularly save your important data.*

### Inserting the SmartMedia card

**BEFORE** you turn on the power of this instrument, make sure to properly insert the included SmartMedia card in the card slot on the rear panel.

With the gold-plated contact side facing down, insert the SmartMedia card firmly but carefully into the card slot, as far as it will go. Be careful not to insert the card upside down or back side in.

\* This instrument uses SmartMedia™ (3.3V) memory cards.

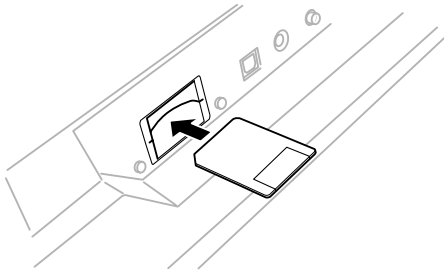

**CAUTION**

- All data residing in the internal memory of the PSR-K1 such as User songs (songs #101 – 105), a User style (style #136), Registration Memory settings (banks #1 – 8), and panel settings will be lost when turning the power off. Because of this, make sure to insert a SmartMedia card as backup media to the CARD slot on the rear panel before turning the power on and use the card to save your important data.

**CAUTION**

- Be careful not to insert or pull out the SmartMedia card while the power is turned on. Doing so may result in damage to the SmartMedia card and the internal data. Make sure to insert and pull out the SmartMedia card only when the power is off.

Make sure to read the section “Using SmartMedia™ cards (memory cards)” on page 11 for more important information on the SmartMedia card.

### Setting up the included microphone

Also included with the instrument is a microphone, letting you enjoy karaoke sing-alongs while playing back the songs, or for singing and playing at the same time.

#### ■ Connecting the microphone

Before turning on the power of this instrument, connect the plug of the included microphone to the MIC jack on the rear panel.

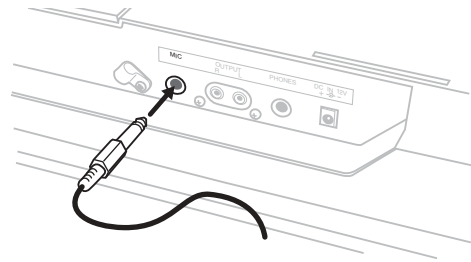

**NOTE**

- To avoid loud pops and sudden noise, turn the volume of the microphone all the way down by turning the [MIC VOLUME] control to the left. Also, set the microphone switch to OFF.

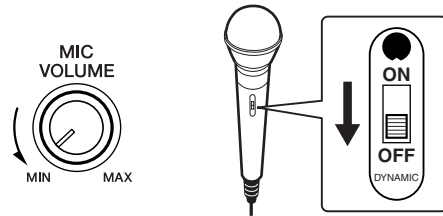

- Use the cable holder next to the MIC jack to securely fasten the cable and prevent the plug from being inadvertently pulled out.

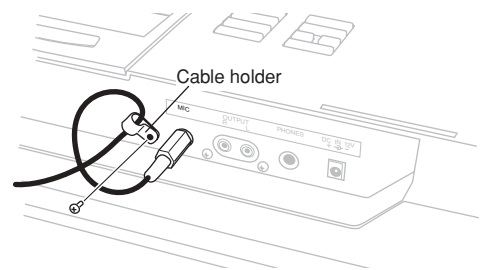

#### ■ Moving the Microphone Holder

The microphone holder can be installed on either side of the instrument. If you remove the holder, put the spare microphone holder cap in the hole.

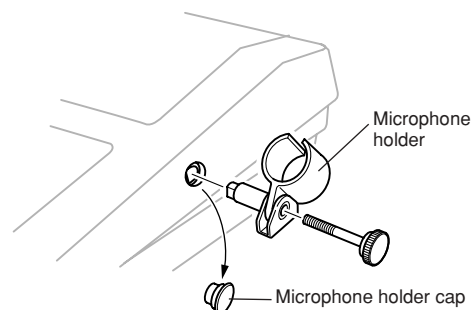

## ■ Precautions concerning the microphone and microphone holder

### **CAUTION**

Avoid leaning or putting any weight on the microphone holder. Doing so may damage the holder and the connected microphone.

- When removing the microphone, pull it out of the handle toward you (as shown).

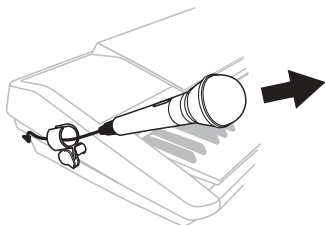

- Do not pull on the microphone cable, or put anything on the microphone when it is connected.
- Do not put any other microphones or anything other than the included microphone in the microphone holder.
- Do not stand the instrument on its microphone holder side.

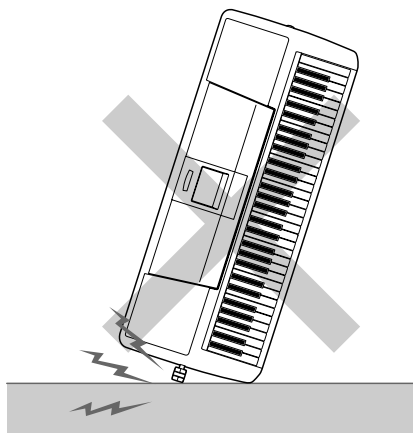

- Do not force the microphone when installing and do not shake it or subject it to sudden, violent movement.

### **NOTE**

The microphone is equipped with an on/off switch. Make sure to leave it off when not in use.

- If you insert the microphone with the switch side sliding past the handle, the switch may inadvertently be turned on. Put the microphone in the holder so that the switch slides into the space of the holder clasp (as shown).

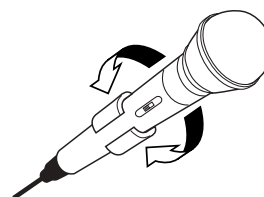

### **NOTE**

If feedback occurs when using the microphone, turn down the [MICVOLUME].

Avoid placing the microphone in close proximity to the speakers, especially with the microphone facing the speaker. This can cause feedback.

- Feedback occurs when a microphone picks up the sound of a speaker, which is then amplified and sent back to the speaker, creating an endless loop of high-pitched noise.



### **CAUTION**

Do not swing the microphone by the microphone cable. In addition to being dangerous to anyone near you, it can also damage the cable and cut off the circuit.

### **CAUTION**

Make sure to take the microphone out of its holder when you carry the instrument. Also, when putting the instrument in a soft case, make sure to take off the microphone holder.

### **CAUTION**

Do not lift the instrument by grabbing the microphone and its holder.

Make all necessary connections below before turning the power on.

### Connecting headphones (PHONES jack)

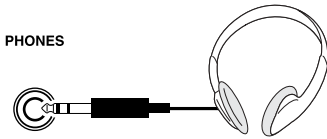

Headphones are connected to the PHONES jack. Connecting headphones to the jack automatically cuts off the sound coming through the internal speakers.

The PHONES jack also can be used as a auxiliary stereo output (with a standard stereo phone plug). By connecting this to the input of a keyboard amplifier, mixing console or tape recorder, you can play the sound and record your performance through the external equipment.

#### **WARNING**

- Avoid listening with the headphones at high volume for long periods of time; doing so may not only result in ear fatigue, it may be damaging to your hearing.

#### **CAUTION**

- To prevent damage to the speakers, set the volume of the external devices at the minimum setting before connecting them. Failure to observe these cautions may result in electric shock or equipment damage. Also, be sure to set the volumes of all devices at their minimum levels and gradually raise the volume controls while playing the instrument to set the desired listening level.

### Connecting to external audio devices (OUTPUT R, L terminal)

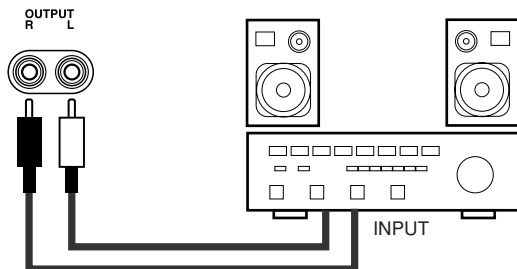

The instrument is equipped with OUTPUT R, L jacks (mono pin plug). By connecting this to the input of a keyboard amplifier, mixing console or tape recorder, you can play the sound and record your performance through the external equipment.

#### **CAUTION**

- To prevent damage to the speakers, set the volume of the external devices at the minimum setting before connecting them. Failure to observe these cautions may result in electric shock or equipment damage. Also, be sure to set the volumes of all devices at their minimum levels and gradually raise the volume controls while playing the instrument to set the desired listening level.

### Connecting a foot switch (SUSTAIN jack)

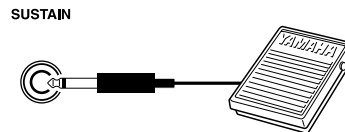

This feature lets you use an optional footswitch (Yamaha FC4 or FC5) to sustain the sound of the voices.

#### **NOTE**

- Make sure that the footswitch plug is properly connected to the SUSTAIN jack before turning on the power.
- Do not press the footswitch while turning the power on. Doing this changes the recognized polarity of the footswitch, resulting in reversed footswitch operation.

### Connecting to a computer (USB terminal)

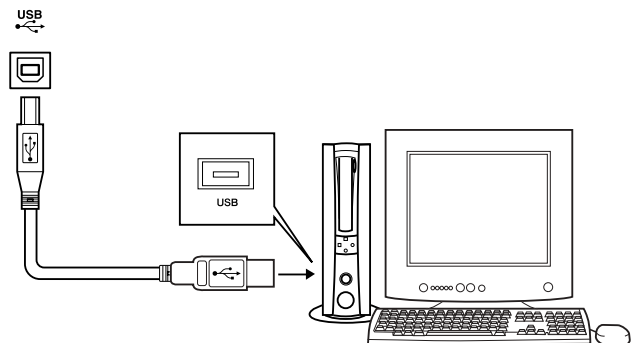

By connecting the USB terminal of this device to the USB terminal of a computer, you can transfer performance data and song files between the devices. (See page 67.)

For example, the Song Filer software (included on the CD-ROM) lets you copy songs on your computer to SmartMedia card for use on the instrument. (Keep in mind that Song Filer cannot be used to transmit data from the PSR-K1 to a computer. Also, when you download songs to SmartMedia card, make sure that the write-protect seal is not affixed to the card.) To use the USB features, you'll need to first install the USB-MIDI Driver to your computer.

#### **NOTE**

- Make sure to purchase a quality USB cable at a musical instrument store, computer store or electrical appliance store.

## Turn on the power

Turn down the volume by turning the [MASTER VOLUME] control to the left and press the [STANDBY/ON] switch to turn on the power.

Pressing the switch again turns the power off.

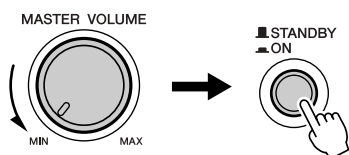

Backup data in the SmartMedia card (page 84) is loaded to the instrument when the power is turned on. If no SmartMedia card is inserted or if no backup data exists on the card, all instrument settings are restored to the initial factory defaults when the power is turned on.

### NOTE

- To disable automatic loading of SmartMedia card backup data, simultaneously hold down the highest white key on the keyboard (C6) and turn on the power. This allows you start the instrument with the default settings yet still use the SmartMedia card.

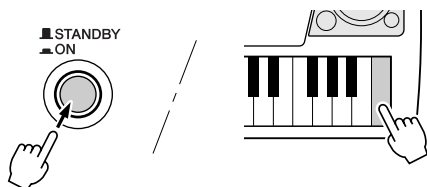

### CAUTION

- Even when the switch is in the "STANDBY" position, electricity is still flowing to the instrument at the minimum level. When you are not using the instrument for a long time, make sure you unplug the AC power adaptor from the wall AC outlet, and/or remove the batteries from the instrument.

### CAUTION

- Never attempt to turn the power off when a "WRITING!" message is shown in the display. Doing so can damage the SmartMedia card and result in loss of data.

## ● Music rest

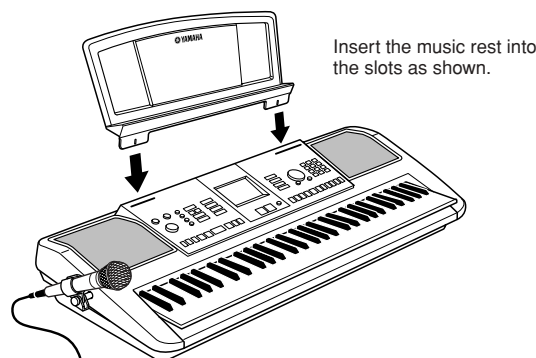



# Panel Controls and Terminals

## ■ Front Panel

- 1 [STANDBY/ON] switch ..... page 15
- 2 [MIC VOLUME] control ..... pages 12, 20
- 3 [MASTER VOLUME] control ..... pages 15, 18
- 4 [TOUCH] button ..... page 43
- 5 [HARMONY] button ..... page 44
- 6 [DUAL] button ..... page 40
- 7 [SPLIT] button ..... page 41
- 8 [DEMO] button ..... page 18
- 9 [LESSON L] (Left) and [LESSON R] (Right) buttons ..... page 34
- 10 [DICTIONARY] button ..... page 50
- 11 [PERFORMANCE ASSISTANT] button ..... page 18
- 12 [FUNCTION] button ..... page 77
- 13 [PC] button ..... page 69
- 14 [METRONOME] button ..... page 42
- 15 [PORTABLE GRAND] button ..... page 40
- 16 [KARAOKE] button ..... page 22
- 17 [SCORE] button ..... page 25
- 18 [EXIT] button ..... page 39
- 19 [SONG] button ..... page 19
- 20 [EASY SONG ARRANGER] button ..... page 57
- 21 [STYLE] button ..... page 30
- 22 [VOICE] button ..... page 26
- 23 [FILE CONTROL] button ..... page 62
- 24 [EXECUTE] button ..... page 62
- 25 Dial ..... page 19
- 26 CATEGORY buttons [▲]/[▼] ..... pages 19, 77
- 27 Numeric keypad  
[0] – [9], [+], and [-] buttons ..... page 19
- 28 [ACMP ON/OFF] / [A ↔ B] button ..... pages 21, 30
- 29 [SYNC STOP] button ..... page 32
- 30 [SYNC START] / [II] button ..... pages 21, 32
- 31 [INTRO/ENDING/rit.] / [◀◀] button ..... pages 21, 30
- 32 [MAIN/AUTO FILL] / [▶▶] button ..... pages 21, 31
- 33 [START/STOP] / [▶/■] button ..... page 18
- 34 [MIC] button ..... page 24
- 35 [TRANPOSE] button ..... page 24
- 36 [TEMPO/TAP] button ..... page 20
- 37 REGISTRATION MEMORY  
[MEMORY], [BANK], [1], [2] buttons ..... page 52
- 38 SONG MEMORY  
[REC], [1] – [5], [A] buttons ..... page 59

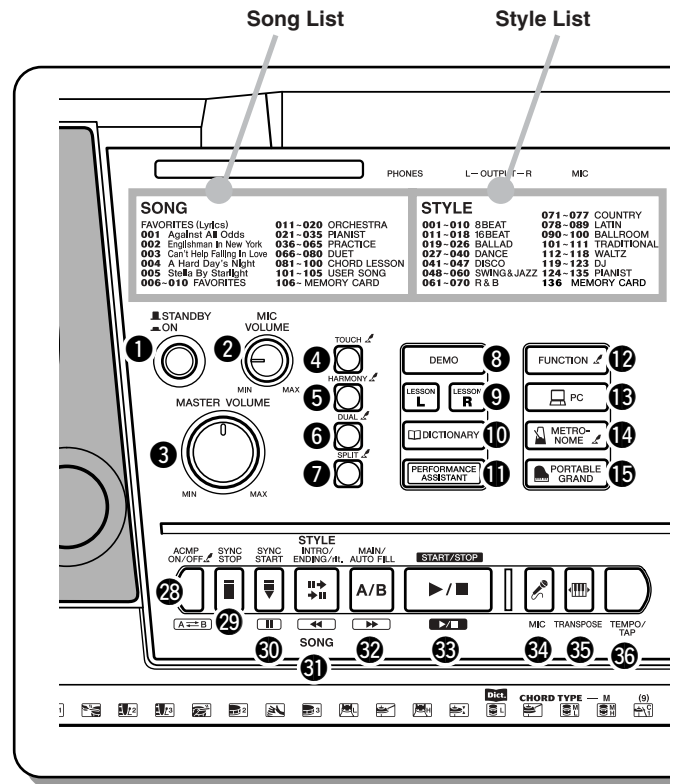

## ■ Rear Panel

- 39 Card slot (for SmartMedia) ..... page 12
- 40 USB terminal ..... page 14
- 41 SUSTAIN jack ..... page 14
- 42 [LCD CONTRAST] knob ..... page 38
- 43 Cable holder ..... page 12
- 44 MIC jack ..... page 12
- 45 OUTPUT R, L jack ..... page 14
- 46 PHONES jack ..... page 14
- 47 DC IN 12V jack ..... page 10



Voice List

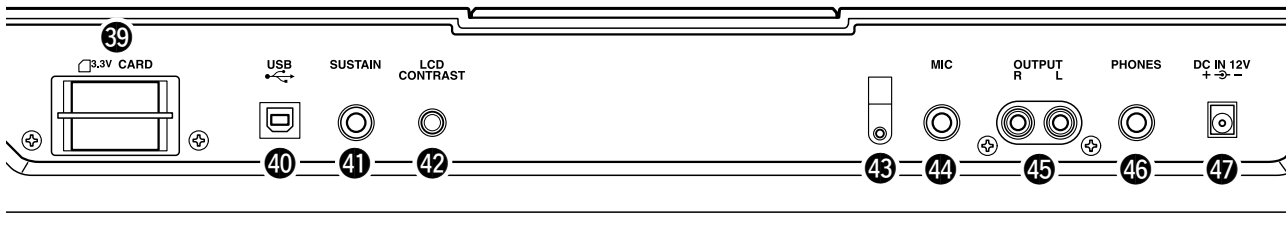
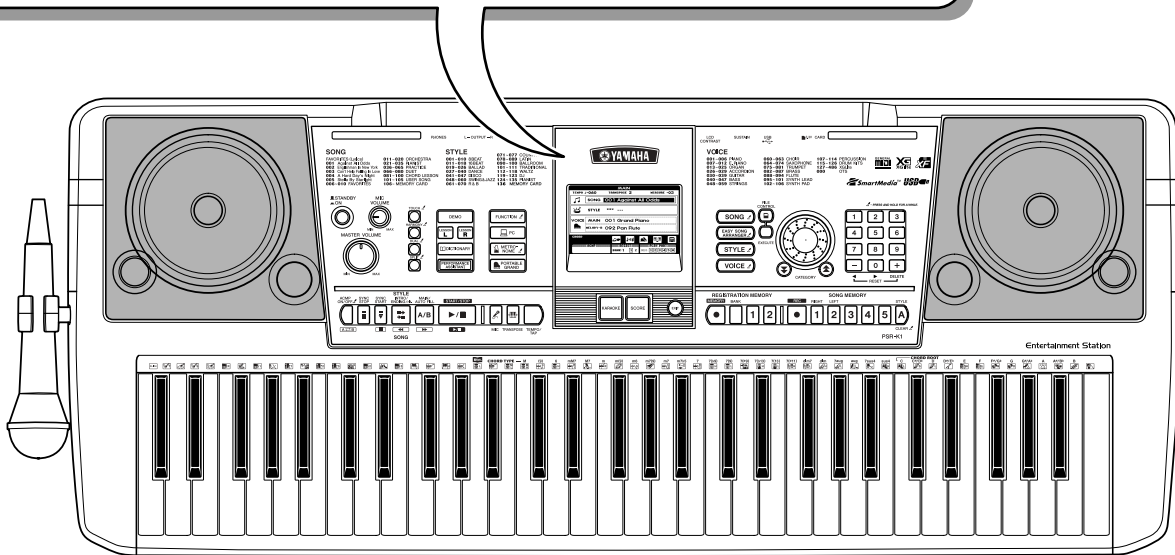
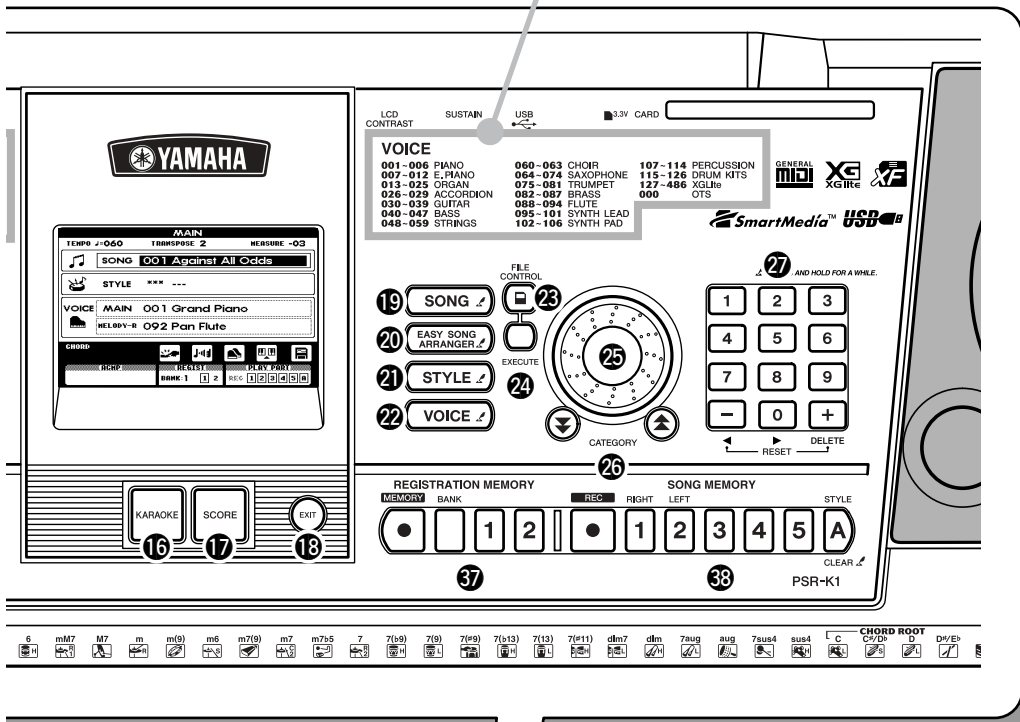

# Play like a pro!

This new instrument has an amazing feature we call the performance assistant. It lets you can easily and instantly sound like a professional keyboard player, even if you've never played a note in your life! No previous musical experience required... Try it out now!

## Playing the Demo Song

Let's start this tour by listening to the Demo Song. It gives you a sampling of the gorgeous voices and advanced functions of this instrument—and at the same time lets you try out the performance assistant.

# 1

### Start the Demo Song by pressing the [DEMO] button.

The Demo Song starts.  
Adjust the volume with the [MASTER VOLUME] control.  
Performance assistant is automatically turned on when the Demo Song plays. (The [PERFORMANCE ASSISTANT] button lights.)

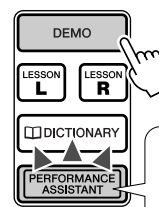
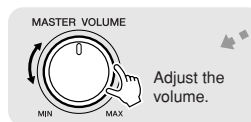

Performance assistant is on during playback of the Demo Song.

# 2

### Play the keyboard.

Don't worry if you don't know what to play. Simply play any keys with both of your hands—like a pianist would—along with the Demo Song.



Amazing, isn't it? And no wrong notes!

This is the magic of the new performance assistant. It reads the chord and harmonic data of the song and makes sure that only appropriate notes are assigned to the keys—so anything you play will sound “right.” Even if you play the same key in succession, the actual pitch may change. This is because the assigned pitch will change automatically along with the chord changes. This is also true for the lower keys you play with your left hand. Try playing several keys simultaneously with your right hand, and notice the perfect sounding chord that results.

But performance assistant goes way beyond that—it even changes the sound according to the way you play. Try playing in the three different ways below.

#### ● Playing the left and right hand together (method 1).

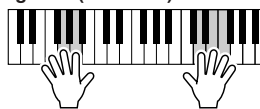

Play three notes at the same time with your right hand.

#### ● Playing the left and right hand together (method 2).

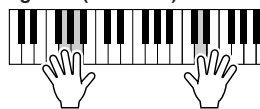

Play several notes one after the other with different fingers of your right hand.

#### ● Playing the left hand and right hand alternately.

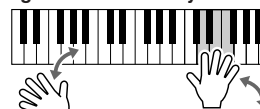

Play three notes at the same time with your right hand.

Did you notice how the sounds changed depending on how you played?

As you can see, performance assistant is an intelligent feature that checks how you play the keyboard and makes the appropriate performance adjustments—automatically! Try it out, playing different songs and using different playing methods.

# 3

### Stop the Demo Song by pressing the [START/STOP] button.

Now that you've played the Demo Song, try out the performance assistant feature with the internal songs.



## Selecting and playing with other songs

Now, let's select another song and try using it with the performance assistant.

Virtually any song is fair game here—from the preset internal songs to commercially available song files and song data downloaded from the Internet.

**NOTE**

In order to properly use the performance assistant, song files must include chord data. performance assistant can be used for any of the internal preset songs, with the exception of the "Pianist" songs. Once you've selected a song, press the [SCORE] or [KARAOKE] button—if the chords are displayed, the performance assistant can be used with the song.

1

### Press the [SONG] button.

The song name and number are highlighted in the MAIN display.

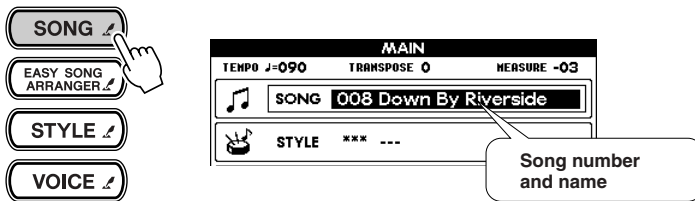

**NOTE**

To use song data downloaded from the Internet (page 70), insert a SmartMedia card to the card slot and transfer the song file to the card (page 70). The first downloaded song file is automatically set to Song number 106 when there are existing songs on the SmartMedia card.

2

### Select the desired song.

First, press and hold the [SONG] button until the Song List (shown below) appears in the display.

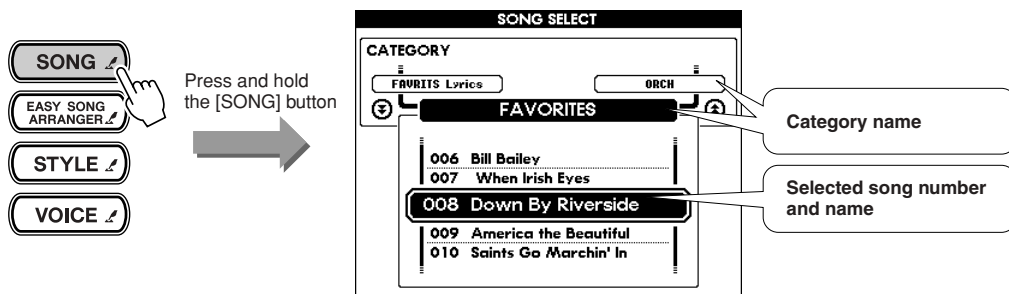

Select the number of the desired song in one of the ways described below.

**Using the dial**  
Turning this clockwise increases the number in single steps, and turning it counterclockwise decreases it. Keep turning the dial to continuously change the number.

**Select the category**

**Using the CATEGORY [▲]/[▼] buttons**  
Use these buttons to step through the various song categories. (See list on page 93.) The first song in the selected category is shown.

**Select the song number directly**

**Using the numeric keypad — number buttons [0] - [9]**  
Use these buttons to directly select the desired song number. Initial zeroes in the number can be omitted (see below).

**Example — To select Song number 003, use one of these ways:**

- Press [0], [0], [3].
- Press [0], [3]. (The display shows "003" after a short pause.)
- Press [3]. (The display shows "003" after a short pause.)

**Using the [+]/[-] buttons**  
Each press of the [+] button increases the number in single steps, while pressing the [-] button decreases it. Hold down either button to continuously increase/decrease the number.

For a list of the internal songs, refer to page 93.

After you've selected the song, press the [EXIT] button to return to the MAIN display.



### 3

Press the [PERFORMANCE ASSISTANT] button.

The [PERFORMANCE ASSISTANT] button lights, indicating that performance assistant is enabled.

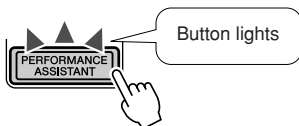

### 4

Press the [START/STOP] button to start the song—and play the keyboard.

Play along with the song with both of your hands. Whether you can actually play or not, performance assistant makes you feel like a real pianist!

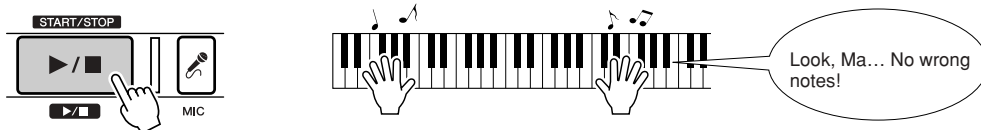

Once the song is finished, it automatically stops. You can also stop the song any time during playback by pressing the [START/STOP] button.

Turn the [PERFORMANCE ASSISTANT] button off, and try playing the keyboard again as you did before. Doesn't quite sound the same, does it? Now you can see just how powerful the performance assistant feature is.

## Performance assistant technology — other convenient controls and features

### ● Singing with a microphone

Thanks to the included microphone, you can easily sing and play at the same time.

To adjust the level of the microphone, use the [MIC VOLUME] control and the [MASTER VOLUME] control.

An echo effect is applied to your voice, and this can also be adjusted. First, press the [MIC] button, then the CATEGORY [▲] button. From the FUNCTION display, change the Mic Echo page (range: 000 - 127) by using the dial or the numeric keypad (buttons [0] - [9], [+]/[-]). (See page 39.)

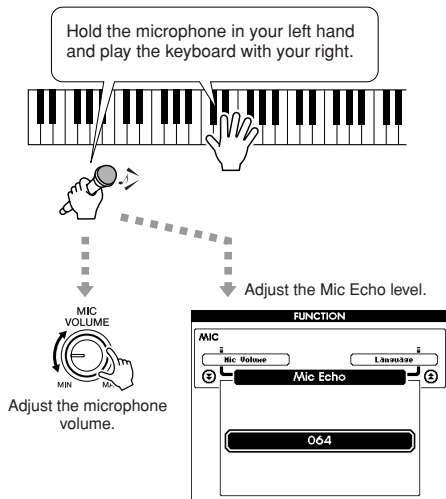

### ● Changing the tempo of the song

To change the speed of the song, press the [TEMPO/TAP] button and use the dial or the numeric keypad (buttons [0] - [9], [+]/[-]) to adjust the tempo (range: 032 - 280 bpm).

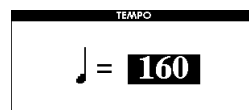
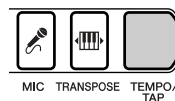

You can even set the tempo manually by tapping it out with the [TEMPO/TAP] button—four times for a song in 4/4, three times for 3/4.

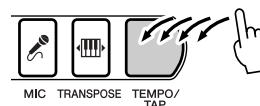

### ● Changing the instrument voice

The instrument sound used for your keyboard performance here is the same as that set for the main voice. You can change this by selecting MAIN in the VOICE row (press the [VOICE] button), and select the desired instrument sound. (See page 26.)

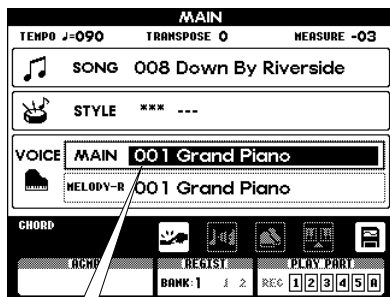

The MAIN VOICE indication is highlighted.

### ● Repeating sections of the song

You can also repeatedly play any desired section in the song by pressing the [A ⇌ B] button during playback—once at the beginning of the section (A) and once at the end (B). You can also set the A and B points when playback is stopped by using the fast-forward and rewind controls. (The A and B points can be set only at measure boundaries.)

To cancel the repeat and return to normal playback, simply press the [A ⇌ B] button again. (See page 56.)

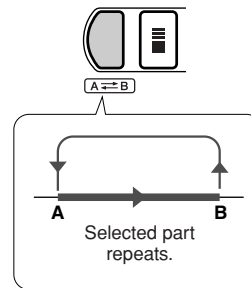

### ● Using fast forward, rewind and pause

These are just like the transport controls on a cassette deck or CD player, letting you fast forward [▶▶], rewind [◀◀] and pause [⏸] playback of the song.

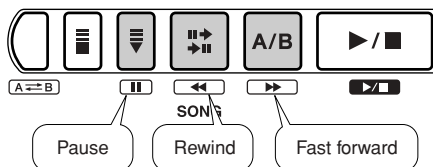

# Sing along—with the Karaoke features!

One of the most enjoyable features of this instrument is that you can easily play and sing along with your favorite songs.

A microphone is included, and both the lyrics and chords are automatically shown in the display. Moreover, echo can be applied to your voice and the tempo can be freely changed.

## Select a song and sing

First, select the song you want to sing. Lyrics can be displayed for the internal songs 001 - 005. Lyrics can also be displayed for song files downloaded from the Internet (page 70) and commercially available song data—provided they are Standard MIDI File format songs with lyric data, such as XF format songs. (For certain songs, lyrics may not be displayed.)

### 1 Press the [SONG] button.

The song name and number are highlighted in the MAIN display.



Selected song number and name

### 2 Select the desired song.

First, press and hold the [SONG] button until the Song List (shown below) appears in the display. Select the song using the same procedure as you did on page 19.



Press and hold the [SONG] button

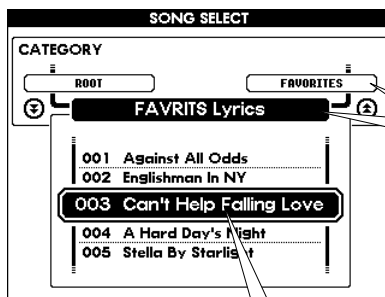

● **Category Name**  
Use the CATEGORY buttons.

● **Song name and number**  
Use the dial or the numeric keypad (buttons [0] - [9], [+]/[-]).

### Hear the song.

To hear the selected song, press the [START/STOP] button. Pressing the button again stops the song.

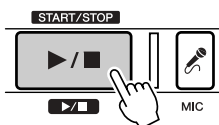

### 3 Call up the Lyrics display by pressing the [KARAOKE] button.

Credits for the selected song, including the title and the names of the composer and lyricist are shown.

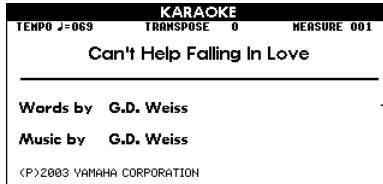

Song credits are shown.

### 4 Start the Karaoke function by pressing the [START/STOP] button.

The song starts playing and the lyrics and chords are automatically shown in the display.

The words of the song are highlighted as the song plays to show you when to sing. Sing into the microphone, and adjust the level if needed by using the [MIC VOLUME] control.

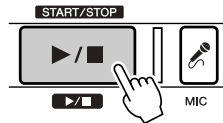

Lyrics and chords are shown.



The words you should sing are highlighted.

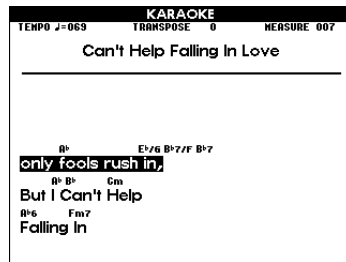
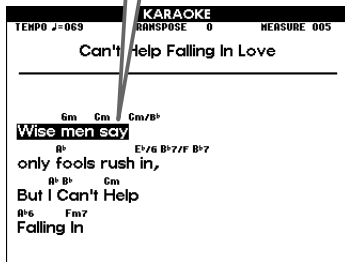

Once the song is finished, it automatically stops. You can also stop the song any time during playback by pressing the [START/STOP] button.

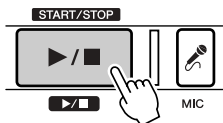

#### Here are some other things you can try...

- Change the key (pitch).....
- Adjust the tempo.....
- Tweak the echo settings.....
- Use the fast forward, rewind and pause controls.
- Repeatedly practice a certain part.....
- Change the instrument sound of the melody.....
- Play the melody by yourself.....
- Finely adjust the level of the microphone.....

See next page.

#### Preset songs containing lyrics

Song Number	Song Name
001	Against All Odds (A. Jamal/R. McNair)
002	Englishman In New York (Sting)
003	Can't Help Falling In Love (G.D.Weiss,H.Peretti and L.Creatore)
004	A Hard Day's Night (J.Lennon and P.McCartney )
005	Stella By Starlight (V.Young)

## Karaoke — other convenient controls and features

### ● Changing the key to suit your voice

Press the [TRANPOSE] button and use the dial or the numeric keypad (buttons [0] - [9], [+]/[-]) to adjust the transpose setting. This can be set in half steps, up to one octave lower or higher (range: -12 - +12).

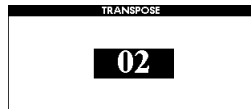
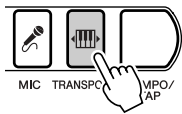

### ● Changing the tempo of the song

Press the [TEMPO/TAP] button and use the dial or the numeric keypad (buttons [0] - [9], [+]/[-]) to adjust the tempo (range: 032 - 280 bpm).

For details, see page 20.

### ● Adjusting the echo effect

Press the [MIC] button, then press the CATEGORY [▲] button once to call up the Mic Echo page in the FUNCTION display. Use the dial or the numeric keypad to change the setting (range: 000 - 127).

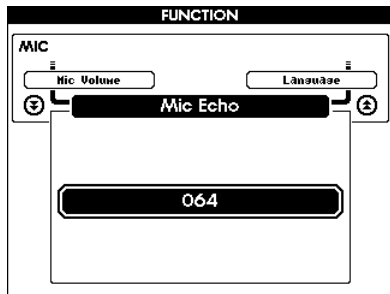
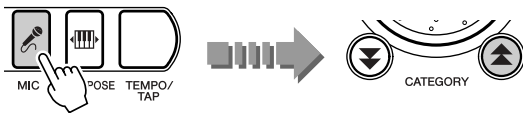

### ● Using the fast forward, rewind and pause controls

You can control the song just as you would on cassette deck or CD player—using these familiar “transport” buttons.

For details, see page 21.

### ● Repeating sections of the song

This convenient practice feature lets you specify any part of the song and repeatedly play it back.

For details, see page 56.

### ● Playing the melody yourself

On the internal songs, Track 1 contains the right-hand performance data while Track 2 contains the left. You can cancel the melody part and practice/play it yourself by muting both Tracks 1 and 2, by pressing the [1] and [2] buttons in the SONG MEMORY section.

For details, see page 56.

### ● Changing the instrument sound for the melody

For internal songs, the melody is played with the instrument sound (voice) that is set to Melody R (VOICE - MELODY R).

To change this, press the [VOICE] button several times so that MELODY R is highlighted in the VOICE row of the display, then select the desired instrument sound.



MELODY R is shown.

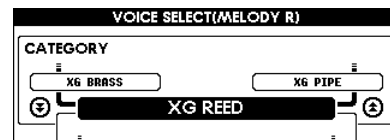

### ● Making fine adjustments to the microphone volume

Call up the Mic Volume page in the FUNCTION display by pressing the [MIC] button.

This page determines the maximum volume for the microphone—the highest level when the [MIC VOLUME] control is turned all the way up. By decreasing this value, you can have more detailed control over the level when using the [MIC VOLUME] control. This setting is memorized even when the power is turned off.

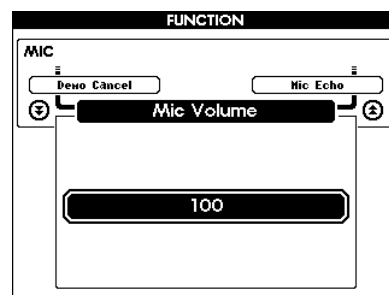
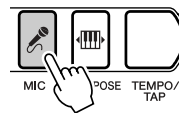



## Sing along with the "electronic" sheet music!

The instrument has a special feature that shows the music notation of the song in the display.

For songs that contain lyric data, the lyrics are displayed along with the notes—letting you read the music, play and sing all at the same time.

Notation can be displayed for the internal songs 001 - 100.

When set to treble-staff display (melody only), both the lyrics and chords can be displayed for internal songs 001 - 005.



**It's easy... After selecting the song, press the [SCORE] button.**

The notation display shows the melody of the song (treble staff only), along with both the lyrics and chords, when such data is contained in the file.

To start the song, press the [START/STOP] button, and the cursor moves in the score as the song plays.

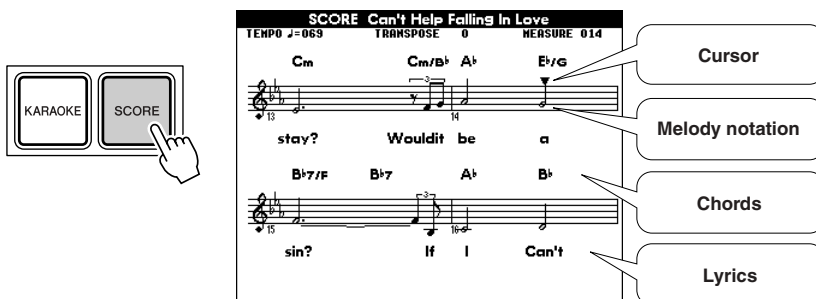

**NOTE**

- Depending on the particular song file, it may take a while for the notation to appear after the [SCORE] button is pressed. (A "Please wait" message appears in the display.)
- You can also display notation for song files downloaded from the Internet. If the downloaded file contains chord and lyric data, the chords and lyrics can also be displayed. (For certain songs, lyrics may not be displayed.)
- Notation cannot be displayed when one of the User songs (101 - 105) is selected. However, if the User song is converted to SMF format and stored to a SmartMedia card (page 64), the notation can be displayed.

If the song lyrics contain a lot of words in a few measures, some of the words may be omitted in the display. If you want to make sure to be able to see all the lyrics, use the Karaoke display (press the [KARAOKE] button).



**Press the [SCORE ] button again to call up the normal lyrics display**

Here, the song is displayed in piano-style notation, with both treble and bass staves.

To start the song, press the [START/STOP] button, and the cursor moves in the score as the song plays.



**NOTE**

- Pressing the [SCORE] button switches between the two types of display.

# Play a variety of different instrument sounds

This versatile keyboard instrument not only features realistic piano and organ sounds, but has a wealth of other sounds as well—including guitar, bass strings, choir, sax, trumpet, drums, percussion and special sound effects.

## Selecting an instrument sound and playing it

Take a look at the instrument (voice) list on the next page. Try out a few of these musical instruments and special effects now and see how they can inspire your performance.

# 1

### Press the [VOICE] button.

The [VOICE] button lights and the VOICE - MAIN row in the MAIN display is highlighted.

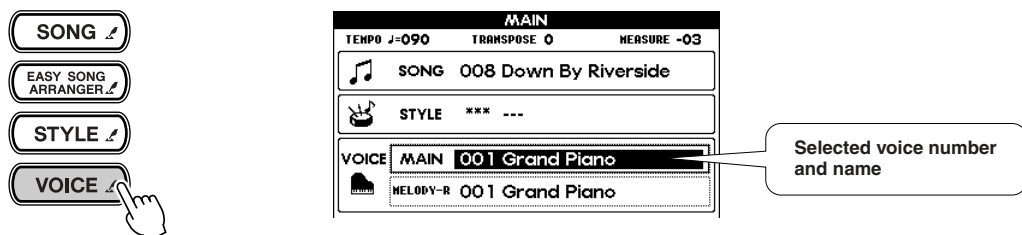

# 2

### Select the number of the desired instrument sound.

First, press and hold the [VOICE] button until the voice list (similar to that shown below) appears in the display. Select the voice using the same procedure as you did on page 19.

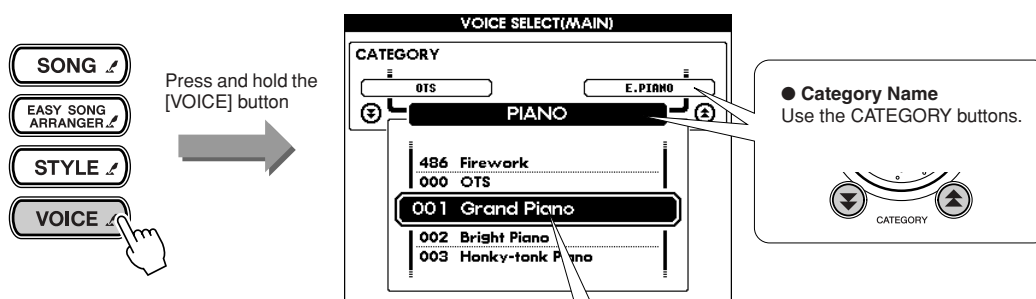

# 3

### Play the sound.

Once the desired voice is called up, play the keyboard.

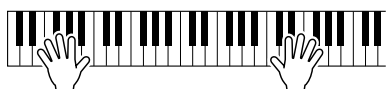

● Voice name and number  
Use the dial or the numeric keypad (buttons [0] – [9], [+]/[-]).

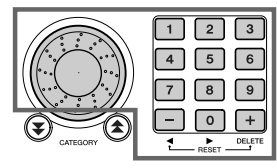

## Play a drum kit from the keyboard!

Unlike the other instrument voices, the drum kits feature a wide variety of drum and percussion sounds, with each individual sound assigned to a separate key. The drum kits (voices 115 - 126) can be called up from the Drum Kit category.

For example, when number 115 (Standard Kit 1) is selected, the percussion sounds below can be played by hitting the appropriate keys. Try it out now.

**ex) 115 Standard Kit 1** (For more details, see the Drum Kit List on page 90.)

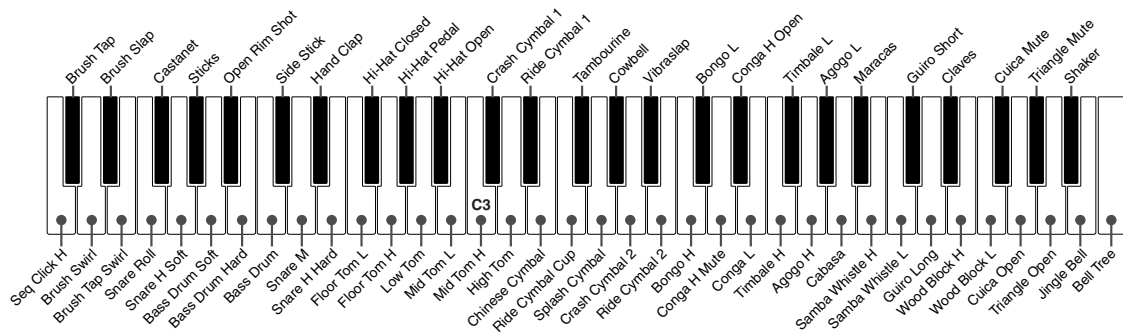

### Panel Voice List

No.	Voice Name	No.	Voice Name	No.	Voice Name	No.	Voice Name
<b>PIANO</b>						<b>SYNTH PAD</b>	
001	Grand Piano	034	Octave Guitar	068	Tenor Sax	102	Fantasia
002	Bright Piano	035	Clean Guitar	069	Breathy Tenor Sax	103	Bell Pad
003	Honky-tonk Piano	036	60's Clean Guitar	070	Baritone Sax	104	Xenon Pad
004	MIDI Grand Piano	037	Muted Guitar	071	Oboe	105	Equinox
005	CP 80	038	Overdriven	072	English Horn	106	Dark Moon
006	Harpichord	039	Distortion	073	Bassoon	<b>PERCUSSION</b>	
<b>E.PIANO</b>		<b>BASS</b>		<b>TRUMPET</b>		107	Vibraphone
007	Galaxy E.Piano	040	Acoustic Bass	075	Sweet! Trumpet	108	Marimba
008	Funky E.Piano	041	Finger Bass	076	Trumpet	109	Xylophone
009	DX Modern E.Piano	042	Pick Bass	077	Muted Trumpet	110	Steel Drums
010	Hyper Tines	043	Fretless Bass	078	Trombone	111	Celesta
011	Venus E.Piano	044	Slap Bass	079	Trombone Section	112	Tubular Bells
012	Clavi	045	Synth Bass	080	French Horn	113	Timpani
<b>ORGAN</b>		046	Hi-Q Bass	081	Tuba	114	Music Box
013	Cool! Jazz Organ	047	Dance Bass	<b>BRASS</b>		<b>DRUM KITS</b>	
014	Jazz Organ 1	<b>STRINGS</b>		082	Brass Section	115	Standard Kit 1
015	Jazz Organ 2	048	String Ensemble	083	Big Band Brass	116	Standard Kit 2
016	Click Organ	049	Chamber Strings	084	Mellow Horns	117	Room Kit
017	Bright Organ	050	Synth Strings	085	Synth Brass	118	Rock Kit
018	Rock Organ	051	Slow Strings	086	Jump Brass	119	Electronic Kit
019	Purple Organ	052	Tremolo Strings	087	Techno Brass	120	Analog Kit
020	16'+2' Organ	053	Pizzicato Strings	<b>FLUTE</b>		121	Dance Kit
021	16'+4' Organ	054	Orchestra Hit	088	Sweet! Flute	122	Jazz Kit
022	Theater Organ	055	Violin	089	Flute	123	Brush Kit
023	Church Organ	056	Cello	090	Piccolo	124	Symphony Kit
024	Chapel Organ	057	Contrabass	091	Sweet! Pan Flute	125	SFX Kit 1
025	Reed Organ	058	Banjo	092	Pan Flute	126	SFX Kit 2
<b>ACCORDION</b>		059	Harp	093	Recorder		
026	Trad Accordion	<b>CHOIR</b>		094	Ocarina		
027	Musette	060	Choir	<b>SYNTH LEAD</b>			
028	Bandoneon	061	Vocal Ensemble	095	Square Lead		
029	Harmonica	062	Vox Humana	096	Sawtooth Lead		
<b>GUITAR</b>		063	Air Choir	097	Voice Lead		
030	Classical Guitar	<b>SAXOPHONE</b>		098	Star Dust		
031	Folk Guitar	064	Sweet! Soprano Sax	099	Brightness		
032	12Strings Guitar	065	Sweet! Tenor Sax	100	Analogon		
033	Jazz Guitar	066	Soprano Sax	101	Fargo		
		067	Alto Sax				

\* This list includes only a portion of the total available voices. (See page 86.)

## Other convenient functions

### ● Calling up your own “portable grand” piano

Simply press the [PORTABLE GRAND] button, and you’ve got a realistic, expressive grand piano voice (001 - Grand Piano) for practicing and playing.

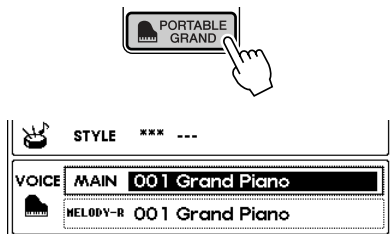

### ● Calling up the best-suited instrument settings for a song or style (000 - OTS)

Once you’ve selected a song or style, you may not know which instrument voices would sound best with it. By selecting Voice 000, the most suitable voice is automatically called up. This convenient function is called One Touch Setting.

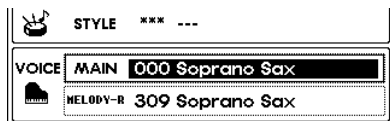

### ● Using the metronome

Pressing the [METRONOME] button gives you a steady click at the tempo of the song or style. Pressing the [TEMPO/TAP] button calls up the Tempo setting, letting you change the tempo. Of course, you can set the metronome time signature, tempo and volume for your own practice or playing. (See page 42.)

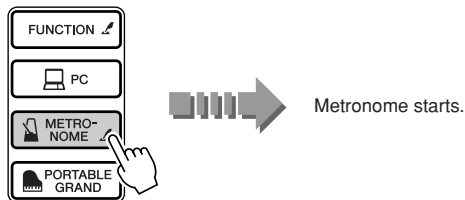

### ● Playing two different voices simultaneously (Dual Voice)

Press the [DUAL] button and hear two separate voices in a layer when you play the keyboard. (See page 40.)

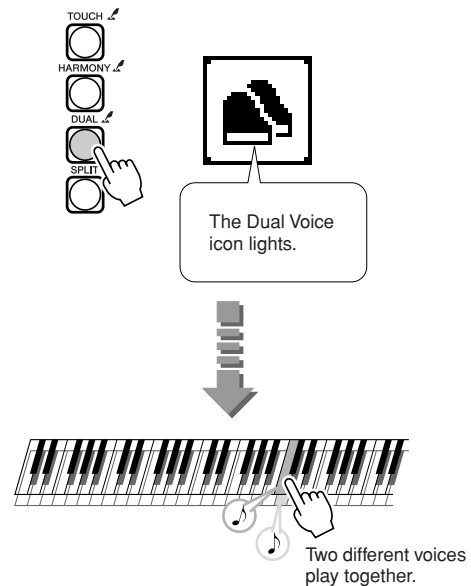

### ● Playing two different voices with your left and right hands (Split Voice)

By pressing the [SPLIT] button, you can play one voice with your right hand (from the keys to the right of the Split Point) and a completely different voice with your left hand. (See page 41.)

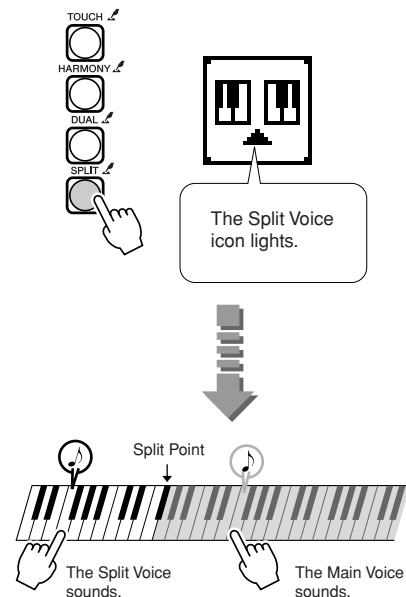

● **Raising or lowering the pitch of the sound (Transpose)**

This function lets you change the overall pitch of the instrument in half steps over a range of one octave, up or down.

For details, see page 24.

● **Finely adjusting the tuning of the sound (Tuning)**

This lets you make fine adjustments to the overall pitch of the instrument over a range of -100 to +100 cents. Adjust this from the Tuning page in the Function display.

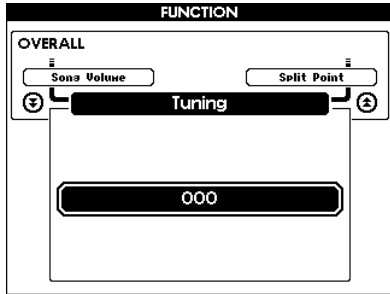
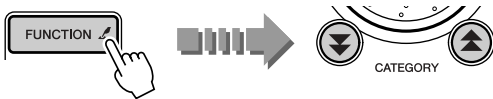

● **Enhancing the sound with various effects (Harmony, Reverb, Chorus)**

You can apply a variety of effects to the sound, such as the Harmony effect which automatically adds instrument harmonies, the Reverb effect which reproduces the ambience of performance environments, and the Chorus effect which can make one voice sound like several played together. (See pages 44, 45.)



The Harmony icon lights.

● **Expressively changing the volume with your playing strength (Touch Response)**

Press the [TOUCH] button to turn on the Touch Response function. This gives you dynamic, expressive control over the sound, letting you play softly or loudly, depending on your playing strength. (See page 43.)



The Touch Response icon lights.

# Try out the Style

One of the most exciting performance features of the instrument, the auto accompaniment function automatically gives you an entire backing band of drums, bass, guitar and other instruments—to perfectly match the chords you play with your left hand. Try playing with this powerful feature now.

## Select a style and play

Select the desired style for use with the auto accompaniment. There are a total of 135 different dynamic, rhythmic styles built into the instrument. See the Style List on page 92.

### 1 Press the [STYLE] button.

The style name and number are highlighted in the MAIN display.

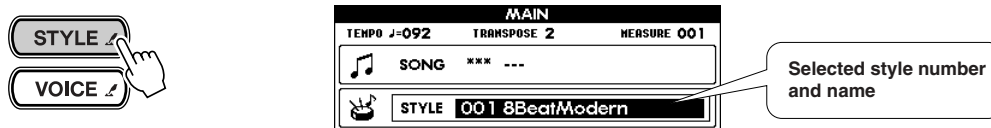

### 2 Select the desired style number.

Press and hold the [STYLE] button until the Style List (shown below) appears in the display.

Select the style using the same procedure as you did on page 19.

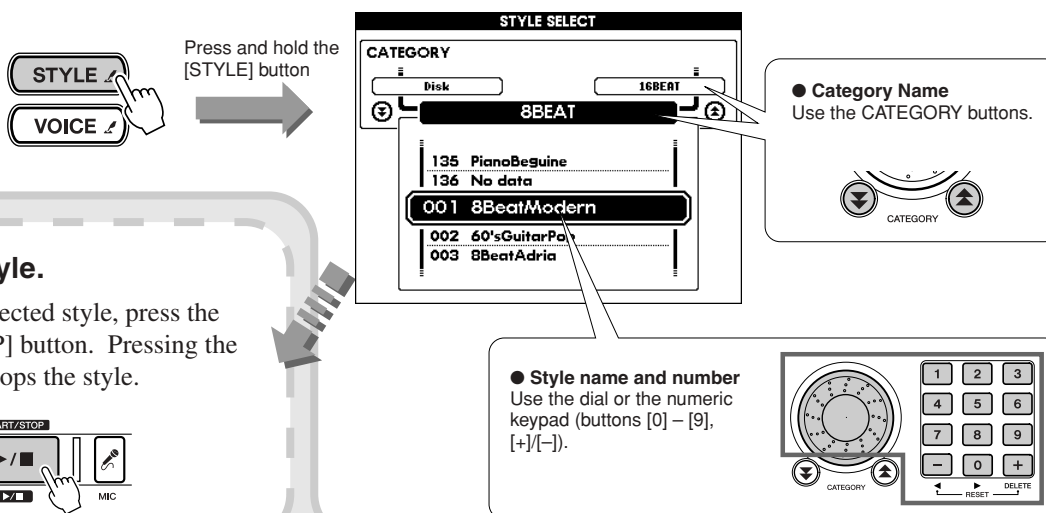

### Hear the style.

To hear the selected style, press the [START/STOP] button. Pressing the button again stops the style.



### 3 Press the [ACMP ON/OFF] button.

This enables the auto accompaniment.

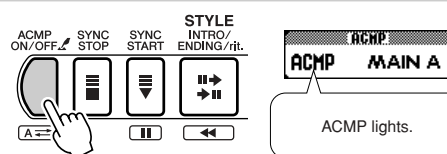

### 4 Press the [INTRO/ENDING/rit.] button.

“INTRO: A” (or “INTRO: B”) is shown in the MAIN display.

This indicates that the main accompaniment pattern A (or B) will follow after the intro plays.

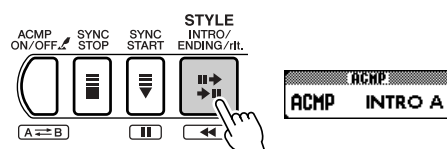

# 5

## Press the [SYNC START] button.

The [START/STOP] button flashes. (Synchro Start is set to stand-by.)

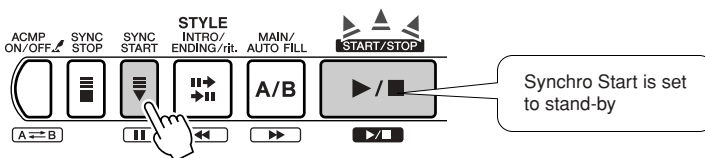

# 6

## Start the style and accompaniment by playing a chord (in the “auto accompaniment” area of the keyboard).

Even if you don’t know how to play a chord, you can easily play the accompaniment! Simply use the “single finger” method (page 48) to play chords. And if you want to learn chords, use the convenient Chord Dictionary (page 50). Just specify the chord name, and it shows you what keys to play.

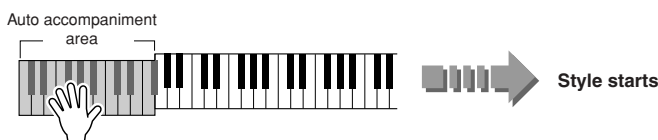

# 7

## Try playing along with the style.

While playing chords with your left hand (in the “auto accompaniment” area of the keyboard), play a melody with your right. The [START/STOP] button flashes in time with the rhythm. (First beat in red, other beats in blue.)

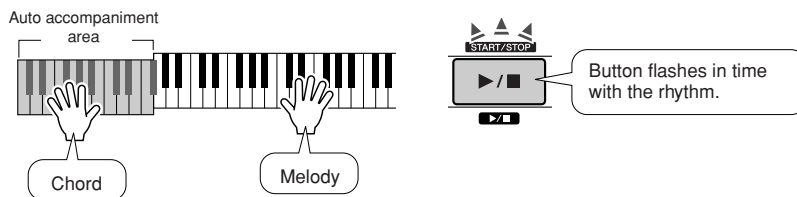

Each style has two main patterns: A and B. Pressing the [MAIN/AUTO FILL] button switches between the two patterns, automatically playing a special fill-in to lead into the change.

● **Playing the style**

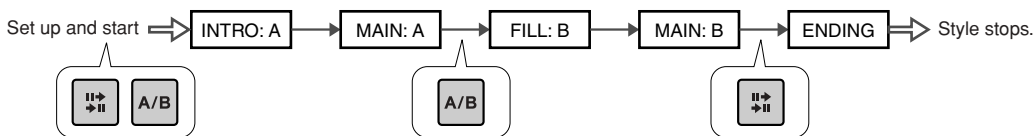

# 8

## To stop the style, press the [INTRO/ENDING/rit.] button.

The style stops after a special ending pattern plays—providing a dynamic finish for your song or performance.

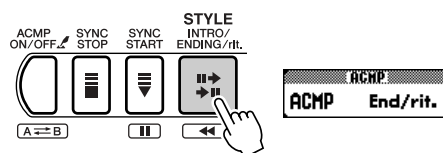

This concludes the basic introduction to auto accompaniment. In the next section, we’ll look at some more ways to enjoy the auto accompaniment features.

## Other useful functions

### ■ Starting the style

You can use one of four ways to start the style.

In all of these types, make sure to first press the [ACMP ON/OFF] button to enable the auto accompaniment.

You may also want to have an intro play to start the style. To do this, press the [INTRO/ENDING/rit.] button. The intro starts with one of the methods below, followed by the main pattern.

#### ● Starting right away

Press the [START/STOP] button. This immediately starts the rhythm part of the style. Bass and other backing parts play as soon as you play chords in the auto accompaniment area of the keyboard.

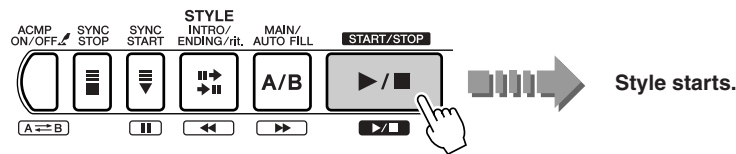

#### ● Starting with a chord

Press the [SYNC START] button. (The [START/STOP] button flashes.) This sets the Synchro Start function to stand-by, letting you start the full accompaniment simply by playing a chord in the auto accompaniment area of the keyboard.

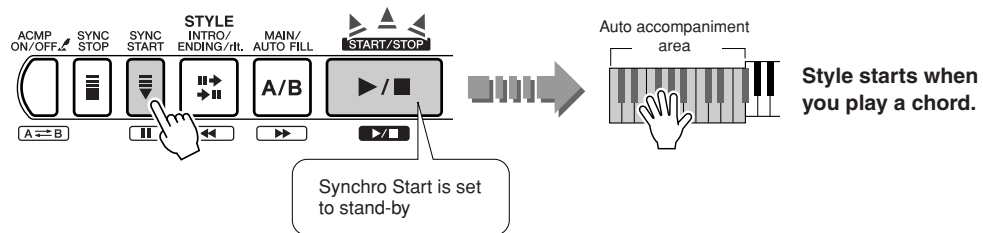

#### ● Starting with a chord, and stopping when you release the keys

Press the [SYNC STOP] button. (The [START/STOP] button flashes.) This sets the Synchro Start function to stand-by, letting you start the full accompaniment simply by playing a chord in the auto accompaniment area of the keyboard.

It also lets you instantly stop the style by releasing your fingers from the keyboard. Synchro Start stays in stand-by, so you can alternately start and stop the style by playing and releasing chords in the auto accompaniment area of the keyboard.

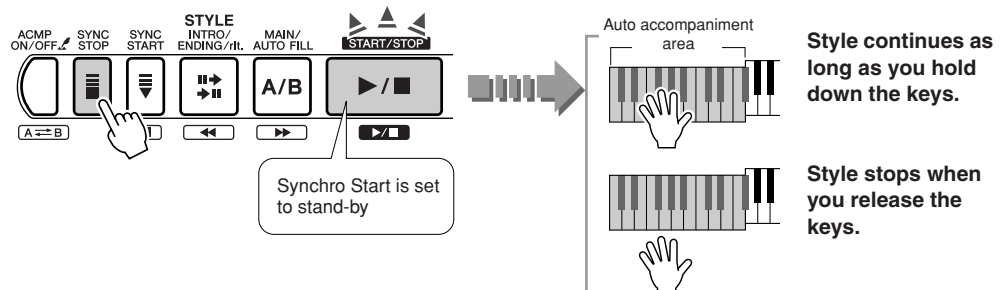

#### ● Starting with a count—tapping the tempo

Start the song by tapping out the basic beat with the [TEMPO/TAP] button—four times for a time signature of 4/4, three times for 3/4. The style starts automatically at the tempo you tapped.





## ■ Stopping the style

The style can be stopped in the following three different ways.

### ● Stopping right away

Press the [START/STOP] button to immediately stop the style.

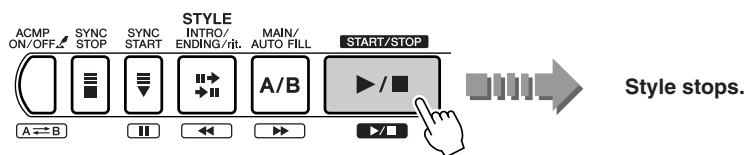

### ● Stopping right away and enabling Synchro Start

Press the [SYNC START] button. This instantly stops the style, yet also sets the Synchro Start function to stand-by (the [START/STOP] button flashes).

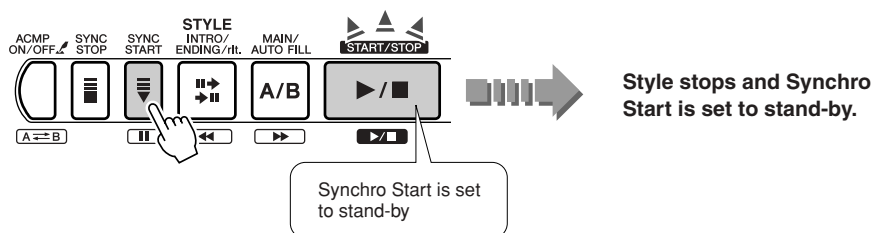

### ● Automatically stopping with an ending pattern

Pressing the [INTRO/ENDING/rit.] button plays a special ending pattern and the style stops.

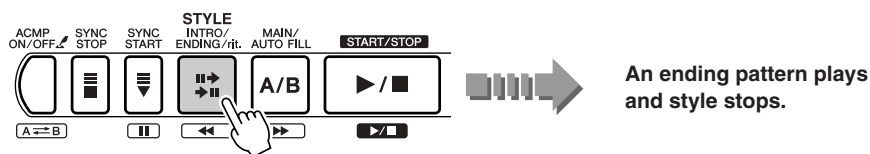

If you press the [INTRO/ENDING/rit.] button again while the ending is playing, the ending pattern smoothly slows down (ritardando) as the style stops.

## ■ Adjusting the tempo

As you saw in “Starting the style” above, you can automatically set the tempo for the style and start it by manually tapping out the beat with the [TEMPO/TAP] button. You can also directly enter a specific tempo value for the style.

For details, see page 20.

## ■ Changing the instrument voice of the melody

The instrument sound used for the melody you play with your right hand is the same as that set for the main voice.

Select the desired instrument sound for the Main Voice.

For details, see page 26.

## ■ Use your favorite style with the song

Another highly useful feature is the **Easy Song Arranger**. It lets you use whatever style you like with the song—for example, playing a ballad with a house arrangement or playing an R&B song with a reggae feel. For details, see page 57.



# Improve your playing skills — with Song Lesson!

Do you have a song you've always wanted to play? The built-in Lesson features of the instrument make it easy and fun to master your favorite tunes. You can learn on your own at your own pace, practicing the right and left hand parts separately, and gradually improving your skills starting with easy-to-learn songs. Don't worry if you have trouble reading music—the sounds and the display will guide you to play correctly. Try it out now!

## Here's how the Lessons progress:

- **Lesson 1** — practicing the timing : Practice only the timing. Any note is fine.
- **Lesson 2** — playing the correct notes : Practice playing the correct notes. Don't worry about the timing.
- **Lesson 3** — practicing with only one hand : Practice playing with only one hand (left or right) along with the accompaniment.
- **Lesson 4** — playing with both hands : Practice playing the song with both hands.

**NOTE** • While the Lesson feature is active, the [KARAOKE] and [SCORE] buttons cannot be used.  
 • If you've selected a song of the Chord Lesson category and are practicing a left-hand only lesson, the melody is shown in the notation part of the display and the indication of how to play the chord is shown in the keyboard part of the display.

## Start out with Lesson 1 — practicing the timing

As you work through the Lesson, play the keys in the melody range with your right hand and play the keys in the accompaniment section with your left, as shown below. Any keys are fine, as long as you play within the range. Make sure to play in time with the rhythm.

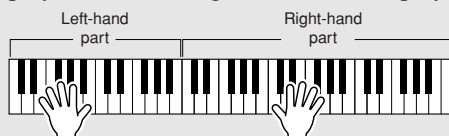

1

### Select the song you want to learn.

Using the same procedure as you did on page 19, select the desired song.

Press and hold the [SONG] button

**Category Name**  
Use the CATEGORY buttons.

**Song name and number**  
Use the dial or the numeric keypad (buttons [0] – [9], [+]/[-]).

2

### Select Lesson 1.

If you want to practice the right-hand part, press the [LESSON R] button. If you want to practice the left, press the [LESSON L] button. Each press of the button steps through the Lessons in order: Lesson 1 → Lesson 2 → Lesson 3 → Off (normal song play) → Lesson 1, etc. The Lesson name appears in the display.

The Lesson song starts automatically after you select Lesson 1.

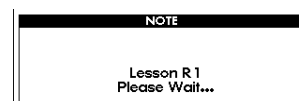
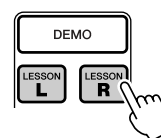

# 3

## Start playing the Lesson.

The timing for playing the keys is indicated in the display—keep your eyes on it, and play along.

As long as you play within the specific range, any key you play is fine. Just concentrate on playing with the correct rhythm. You'll hear the sound of the notes if your timing is correct.



LESSON Little Brown Jug [R] 1

TEMPO ♩=130 TRANPOSE 0 MEASURE -01

C6

F6 F#dim7 G7

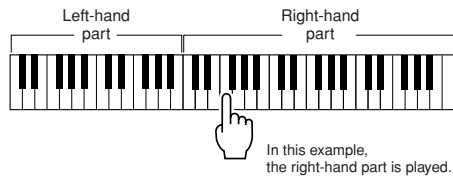

The Lesson stops automatically when the song is finished. To stop the song in the middle, press the [START/STOP] button.

### If you'd like to know how well you did...

Once you practice a song all the way to its end, the instrument automatically evaluates your performance and displays your grade—OK, Good, Very Good, Excellent. Once your evaluation is shown, the song and Lesson automatically start from the beginning again.

**NOTE**

- You can turn the evaluation function off if you want. Do this from Grade page in the FUNCTION display (page 79).



Once you've mastered Lesson 1, go on to Lesson 2.

## Change the tempo

To learn more easily, you may want to change the tempo to a more comfortable speed.

- 1 [Press the [TEMPO/TAP] button.]

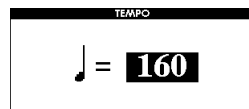
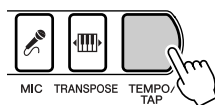

- 2 Change the tempo by using the dial or the numeric keypad (buttons [0] - [9], [+]/[-]).

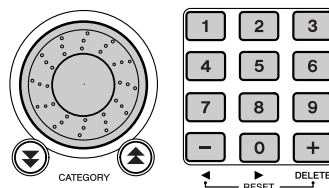

You can also set the tempo by “feel,” tapping out the beat with the [TEMPO/TAP] button—four times for a time signature of 4/4, three times for 3/4.

## Lesson 2 — playing the correct notes

The display shows a keyboard and piano-style notation, indicating the particular key or keys you should play along with the notes in the score. The accompaniment waits for you, continuing when you play the correct note.

1

### Select Lesson 2.

Press the [LESSON R] or [LESSON L] button until Lesson 3 is selected. If you want to practice the right-hand part, press the [LESSON R] button. If you want to practice the left, press the [LESSON L] button.

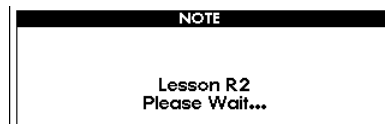
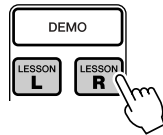

The Lesson song starts automatically after you select Lesson 2.

2

### Start the Lesson.

Look at the keyboard in the display. You'll see a mark indicating the key you should play first. A mark above the music notation indicates the particular note you should play.

Both of these markers move to the next key and note once you play the key correctly. The accompaniment also continues as soon as you play the correct note.

**NOTE**

- *Drum and percussion sounds do not play in Lesson 2.*

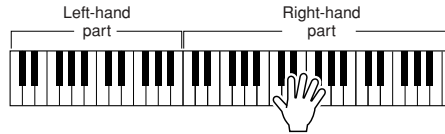

In this example, the right-hand part is played.

Once you practice the song all the way to the end, playback stops and your grade is displayed.

Now, let's go on to Lesson 3 and master the right-hand (or left-hand) part.

## Lesson 3 — practicing with only one hand

The accompaniment and one of the parts play back—minus the one part you want to practice. Practice the desired part, right hand or left hand, along with the accompaniment.

1

### Select Lesson 3.

Press the [LESSON R] or [LESSON L] button until Lesson 3 is selected. If you want to practice the right-hand part, press the [LESSON R] button. If you want to practice the left, press the [LESSON L] button.

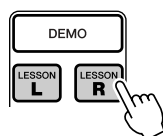

The Lesson song starts automatically after you select Lesson 3.

# 2

## Start the Lesson.

The accompaniment sounds, however the part you want to practice is muted (off). Listen to the song carefully as you play along. The notes and keys you should play are properly indicated in the display.

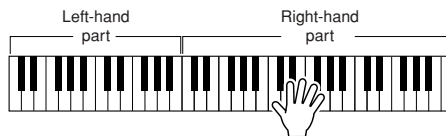

In this example, the right-hand part is played.

Once you practice the song all the way to the end, playback stops and your grade is displayed.

After you've mastered both the left- and right-hand parts, go on to Lesson 4 and try playing the song with both hands.

## Lesson 4 — playing with both hands

In the final Lesson, the accompaniment sounds—this time with both the right and left parts muted (off). Practice both hands in time with accompaniment.

# 1

## Select Lesson 4.

Press both the [LESSON R] and [LESSON L] buttons simultaneously.

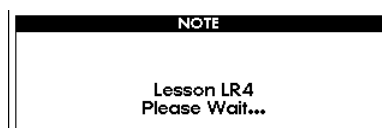
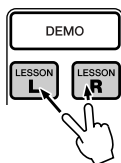

The Lesson song starts automatically after you select Lesson 4.

# 2

## Start the Lesson.

The accompaniment sounds, however the parts you want to practice are muted (off). Listen to the song carefully as you play along. The notes and keys you should play are properly indicated in the display.

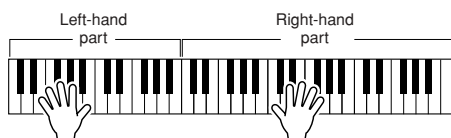

Once you practice the song all the way to the end, playback stops and your grade is displayed.

How did you do? Were you able to master the song—with both hands?

**NOTE**

• **Using the Lessons with SmartMedia card song data**  
 Any Standard MIDI File song data (Format 0; see page 54) you've purchased or have downloaded from the Internet (page 70) can also be used with the Lesson features. However, you'll need to specify beforehand which tracks are to be used for the right- and left-hand parts. Do this from the R-part, L-part pages in the FUNCTION display (page 77).



# Basic operations and the LCD display

## Adjusting the volume

The [MASTER VOLUME] control affects both the volume of the speakers and the volume of headphones connected to the PHONES jack.

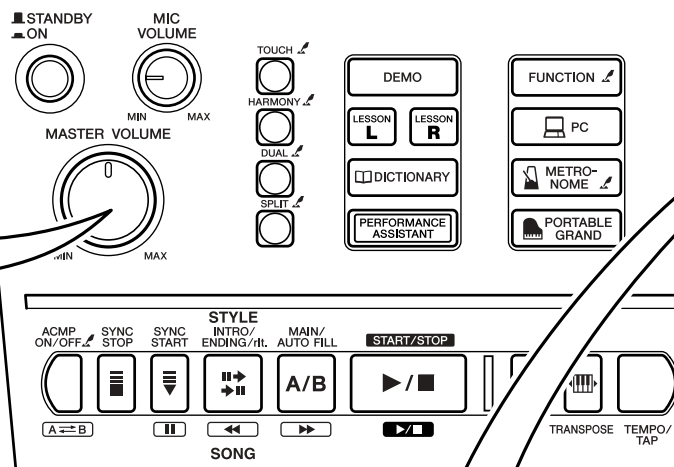
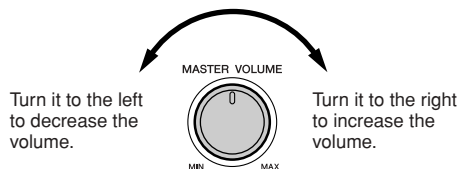

## MAIN display

When the power is turned on, the MAIN display automatically appears. This display shows at a glance the basic settings of the instrument, including the current song, style, voice, and other settings.

**Tempo**: TEMPO ♩=060

**Transpose**: TRANSPOSE 2

**Repeat indication**: (A=B) MEASURE -03

**LOW BATTERY!!**: Battery power is too low for proper operation. Replace all batteries right away. (See page 10.)

**Measure number**: MEASURE -03

**Song number and name**: SONG 001 Against All Odds

**Style number and name**: STYLE \*\*\* ---

**Voice number and name**: VOICE MAIN 001 Grand Piano  
MELODY-R 092 Pan Flute

**Chord indication**: CHORD G

**ACMP**: Lights when auto accompaniment is ON.

**Registration Memory bank and number**: REGIST BANK:1 1 2

**Song track**: Frame is off when track is muted.

**REC**: Lights when a User song is being recorded.

**Style pattern name**: MAIN A

**Touch response**: Lights when set to ON.

**Harmony**: Lights when set to ON.

**Dual voice**: Lights when set to ON.

**Split voice**: Lights when set to ON.

**File control**: Lights when SmartMedia card is accessible. \* SmartMedia card is not accessible when indication is off.

**ACMP**: Lights when Synchro Stop is ON.

**Style pattern name**: MAIN A

**REC**: Lights when a User song is being recorded.

**\* To adjust the display contrast for best viewing, use the [LCD CONTRAST] knob on the rear panel.**

**LCD CONTRAST**

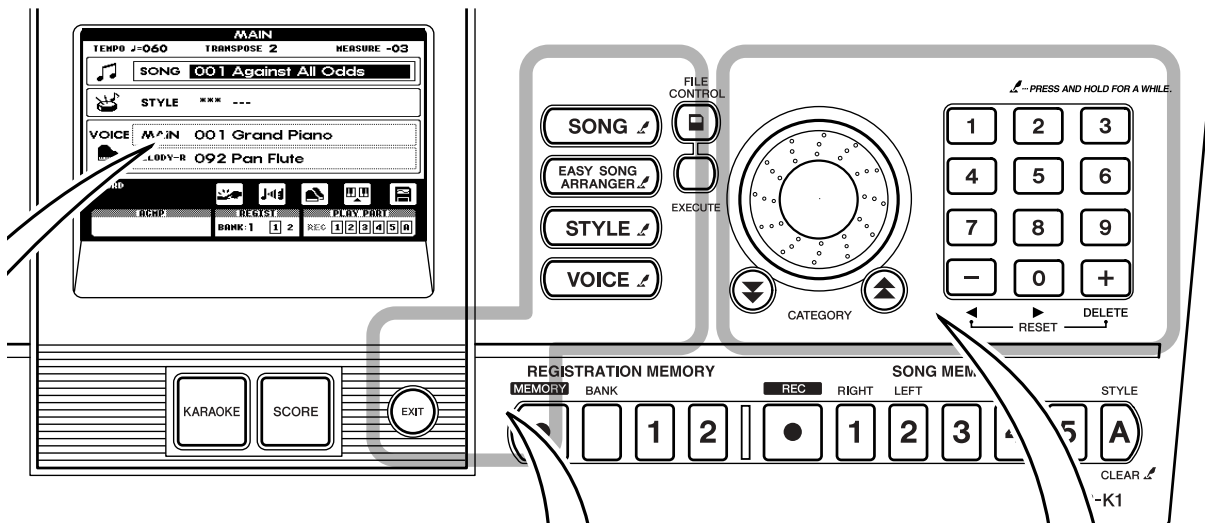

### Panel controls — operation

- Select one of the basic functions of the instrument by pressing the [SONG], [EASY SONG ARRANGER], [STYLE] and [VOICE] buttons. (The button of the selected function lights.)



- Certain buttons having the printed indication on the panel (  ) can be used to call up additional functions and settings related to the button. To do this, hold down the relevant button for longer than one second.



- To call up the lists of songs, styles or voices, hold down one of the relevant buttons: [SONG], [EASY SONG ARRANGER], [STYLE] or [VOICE].

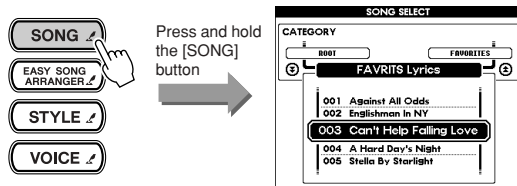

- To return to the previous display, press the [EXIT] button.



### Making settings and changing values

#### ● Dial

Turning this to the right (clockwise) increases the value in steps, and turning it left (counter-clockwise) decreases the value. Keep turning the dial to continuously change the value.

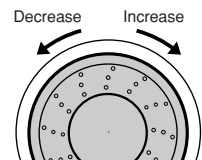

#### ● [+]/[-] buttons

Press the [+] button once to increase the value by one, and press the [-] button to decrease the value. Hold down the button to continuously change the value.

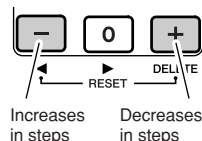

#### ● CATEGORY buttons [▲]/[▼]

When selecting a song, style or voice, the top number of each category is selected for each press of the button.



These step through the categories.

#### ● Numeric keypad [0] – [9]

This lets you directly enter values, such as song numbers and so on.

Initial zeroes in the number can be omitted, as described below.

**Example — To select Song number 003, use one of these ways:**

- Press [0], [0], [3].  
(The display shows "003" after a short pause.)
- Press [0], [3].  
(The display shows "003" after a short pause.)
- Press [3].  
(The display shows "003" after a short pause.)

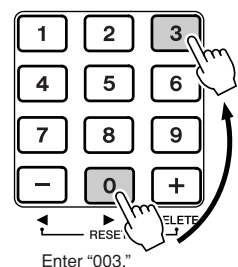



# Playing Voices — Related Functions

In this section, we'll describe the various functions used when selecting and playing voices.

For basic information and instructions, refer to the sections “Play a variety of different instrument sounds” (page 26) and “Basic operations and the LCD display” (page 38).

## Playing the grand piano settings (Portable Grand)

For those times when you simply want to play or practice the piano, all you have to do is press the [PORTABLE GRAND] button. This automatically calls up the grand piano voice (001 Grand Piano) for the Main Voice.



### NOTE

- Pressing the [PORTABLE GRAND] button sets the instrument to the following settings:
  - Set to ON : Touch Sensitivity
  - Set to OFF : Auto Accompaniment (ACMP), Dual, Split, Harmony, Performance assistant, Metronome

## Selecting and playing a voice

The basic instrument sound used for your keyboard performance is called the Main Voice.

### Selecting the Main Voice

- Press the [VOICE] button so that “MAIN” appears in the VOICE row in the display.
- Select the desired voice's number and name.

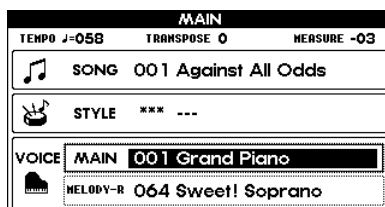

### NOTE

- To call up the voice list, hold down the [VOICE] button.

### Main Voice settings

The settings below related to the Main Voice are set in the FUNCTION display (page 77).

- Volume (M. Volume)
- Octave (M. Octave)
- Pan (M. Pan)
- Reverb send level (M. Reverb Level)
- Chorus send level (M. Chorus Level)

## Playing two different voices together (Dual)

When you play the keyboard with this function, the Main Voice and another separate voice (Dual Voice) are mixed together in a layer.

### Turning Dual Voice on/off

Turn the Dual Voice on or off by pressing the [DUAL] button.

When the Dual Voice is on, the Dual Voice icon in the display lights up. When Dual is off, the icon goes out.

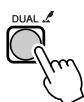

### NOTE

- Dual Voice cannot be used with the Song Lesson features.



### ■ Selecting the Dual Voice

- 1 Press and hold the [VOICE] button until the Voice List appears.
- 2 Then press [VOICE] so that “Dual” appears at the top.
- 3 Select the desired voice’s number and name.

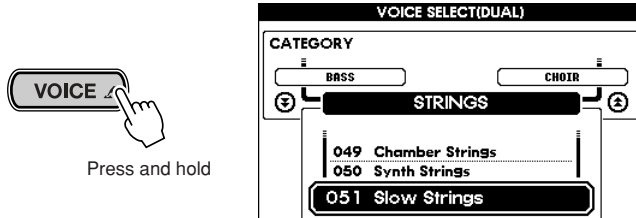

### ■ Dual Voice settings

The settings below related to the Dual Voice are set in the FUNCTION display (page 77).

- Volume (D. Volume) \* Hold down the [DUAL] button to call up this setting.
- Octave (D. Octave)
- Pan (D. Pan)
- Reverb send level (D. Reverb Level)
- Chorus send level (D. Chorus Level)

## Playing different voices with your left and right hands (Split)

With this function, you can play one voice with your right hand (from the keys to the right of the Split Point) and a completely different voice with your left hand.

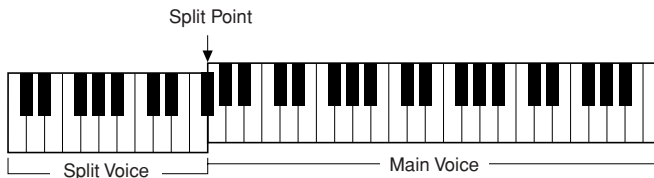

### ■ Turning Split Voice on/off

Turn the Split Voice on or off by pressing the [SPLIT] button.

When the Split Voice is on, the Split Voice icon in the display lights up. When Split is off, the icon goes out.

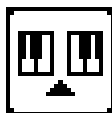

**NOTE**

- Split Voice cannot be used with the Song Lesson features.

### ■ Selecting the Split Voice

- 1 Press and hold the [VOICE] button until the Voice List appears.
- 2 Then press [VOICE] so that “SPLIT” appears at the top.
- 3 Select the desired voice’s number and name.

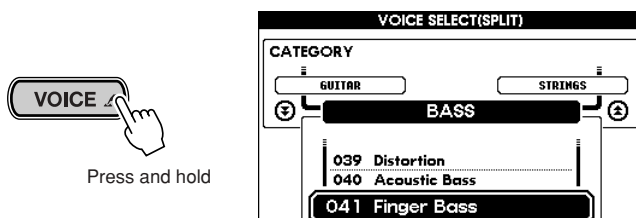

## Split Voice settings

The settings below related to the Split Voice are set in the FUNCTION display. (page 77).

- Volume (S. Volume) \* Hold down the [SPLIT] button to call up this setting.
- Octave (S. Octave)
- Pan (S. Pan)
- Reverb send level (S. Reverb Level)
- Chorus send level: (S. Chorus Level)

## Setting the Split Point

The Split Point is initially set to a default value of 54 (F#2), but it can be changed freely.

- 1 Call up the Split Point page in the FUNCTION display by holding down the [ACMP ON/OFF] button.
- 2 Set the Split Point key. The range is 000 (C-2) – 127 (G8).

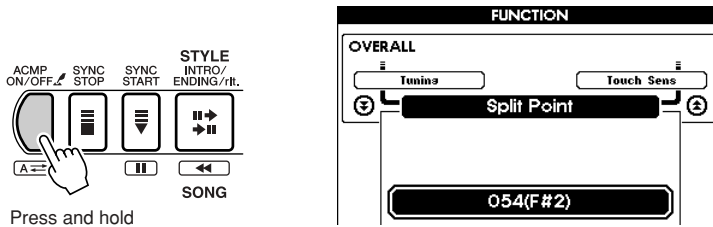

### NOTE

- Changing the Split Point value here also changes the Split Point of the auto accompaniment.
- The Split Point cannot be changed while the Song Lesson is used. (fixed)
- Playing the Split Point key sounds the Split Voice.

### NOTE

- The above method is a shortcut. You can also select the Split Point page from the FUNCTION display after pressing the [FUNCTION] button. (See page 77.)

## Using the Metronome

The Metronome can be set to any time signature, up to fifteen beats. When the time signature is set to “00,” there is no accented first beat.

The Metronome is automatically set to the tempo and time signature of the selected song or style; however, this can be set freely.

## Starting/stopping the Metronome

- 1 Start the Metronome by pressing the [METRONOME] button.
- 2 To stop the Metronome, press the [METRONOME] button again.



## Setting the tempo of the Metronome

- 1 Call up the TEMPO display by pressing the [TEMPO/TAP] button.
- 2 Set the desired tempo. The range is 032 – 280 bpm (beats per minute).



### ■ Setting the time signature

- 1 Call up the Time Signature page in the FUNCTION display by holding down the [METRONOME] button.
- 2 Set the beat value (00 – 15).

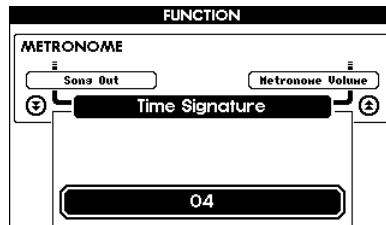
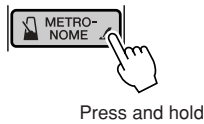

**NOTE**

- The above method is a shortcut. You can also select the Time Signature page from the FUNCTION display after pressing the [FUNCTION] button. (See page 77.)

### ■ Setting the volume of the Metronome

- 1 Enter the FUNCTION display by pressing the [FUNCTION] button and call up the Metronome Volume page by using the CATEGORY buttons [▲]/[▼].
- 2 Set the metronome level (000 – 127).

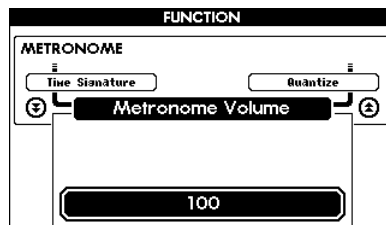

## Dynamically change the volume by your playing strength (Touch)

The Touch Response feature gives you the natural expressiveness of an acoustic instrument, such as that of a real piano—letting you dynamically alter the volume of the notes with your playing technique and strength. If you want to disable this feature and have all notes sound at the same volume, set Touch Response to OFF.

### ■ Turning Touch Response on/off

Turn the Touch Response on or off by pressing the [TOUCH] button. When the Touch Response is on, the Touch Response icon in the display lights up. When Touch Response is off, the icon goes out.



### ■ Setting the sensitivity of Touch Response

You can set the touch sensitivity for the instrument over a range of three steps. This determines to what degree the volume responds to changes in your playing strength, when Touch Response is ON.

- 1 Call up the Touch Sensitivity page in the FUNCTION display by holding down the [TOUCH] button.
- 2 Set the Touch Sensitivity value (range: 1 – 3). The greater the value, the more the level changes in proportion to your playing strength.

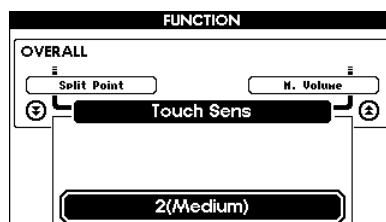

**NOTE**

- The default Touch Sensitivity value is set to “2.”

**NOTE**

- The above method is a shortcut. You can also select the Touch Sensitivity page from the FUNCTION display after pressing the [FUNCTION] button. (See page 77.)

## Adding harmony sounds (Harmony)

This function automatically adds appropriate harmony sounds to the voices you play on the keyboard (Main Voice). It also features special performance embellishments such as trill, tremolo and echo.

The particular effects and use of Harmony differs depending on the selected Harmony type. For details, see the Effect Type List on page 46.

**NOTE**

- When you change the Main Voice, the Harmony type automatically changes to best suit the selected voice.

### ■ Turning Harmony on/off

Turn the Harmony effect on or off by pressing the [HARMONY] button.

When the Harmony is on, the Harmony icon in the display lights up. When Harmony is off, the icon goes out.



**NOTE**

- Harmony cannot be turned on or off while the Song Lesson features are used.
- Harmony types 01 – 05 function only in conjunction with the auto accompaniment. For these types, appropriate harmony notes are automatically added to the sound of the keys you play with your right hand, according to the chords you play with your left in the accompaniment section of the keyboard.

### ■ Selecting the Harmony type

- 1 Call up the Harmony Type page by holding down the [HARMONY] button.
- 2 Select the desired Harmony type (01 – 26).

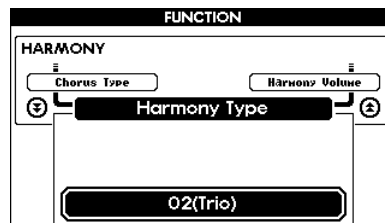

**NOTE**

- The method at left is a shortcut. You can also select the Harmony Type page from the FUNCTION display after pressing the [FUNCTION] button. (See page 77.)

### ■ Adjusting the Harmony level

The Harmony Level can be adjusted for the Harmony types 01 (Duet) – 05 (Octave).

- 1 Enter the FUNCTION display by pressing the [FUNCTION] button and call up the Harmony Volume page by using the CATEGORY buttons [▲]/[▼].
- 2 Set the Harmony level (000 – 127).

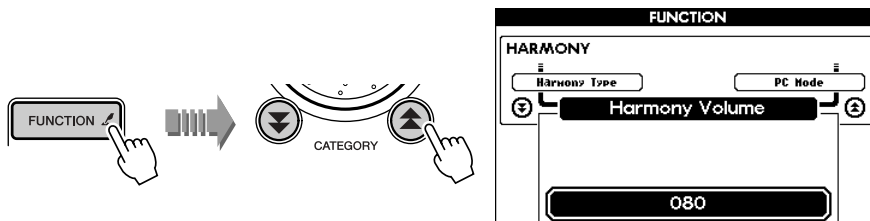

## Applying the Reverb effect

This lets you add natural ambience and reverberation to the sound of the instrument. For details on the Reverb types, see the Effect Type List on page 46.

**NOTE**

• When you select a style or song, the Reverb type best suited to the music style is automatically selected.

### ■ Selecting the Reverb type

- 1 Enter the FUNCTION display by pressing the [FUNCTION] button and call up the Reverb Type page by using the CATEGORY buttons [▲]/[▼].
- 2 Set the Type Reverb type.

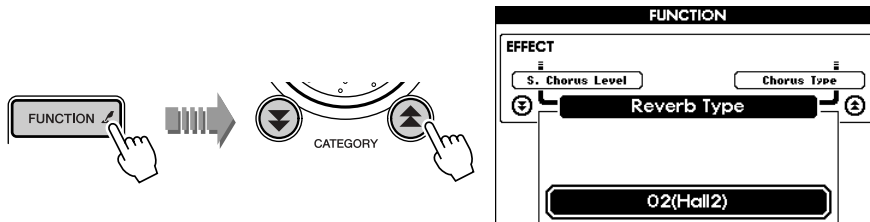

### ■ Adjusting the Reverb Send level

You can adjust the Reverb independently for each voice (Main, Dual and Split). This can be set in the Reverb Send Level page for each voice in the FUNCTION display (page 77).

- Main Voice (M. Reverb Level)
- Dual Voice (D. Reverb Level)
- Split Voice (S. Reverb Level)

## Applying the Chorus effect

This lets you enhance the sound with chorus effects, to make the sound warmer or more animated.

For details on the Chorus types, see the Effect Type List on page 46.

**NOTE**

• When you select a style or song, the Chorus type best suited to the music style is automatically selected.

### ■ Selecting the Chorus type

- 1 Enter the FUNCTION display by pressing the [FUNCTION] button and call up the Chorus Type page by using the CATEGORY buttons [▲]/[▼].
- 2 Set the Chorus type.

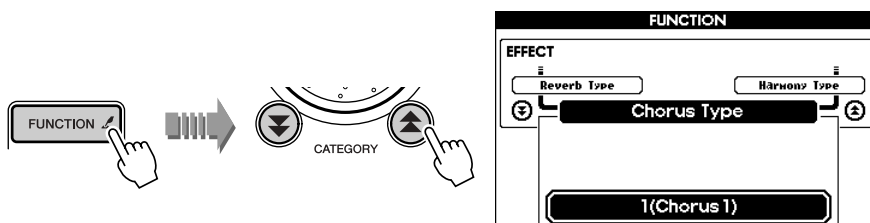

### ■ Adjusting the Chorus Send level

You can adjust the Chorus independently for each voice (Main, Dual and Split). This can be set in the Chorus Send Level page for each voice in the FUNCTION display (page 77).

- Main Voice (M. Chorus Level)
- Dual Voice (D. Chorus Level)
- Split Voice (S. Chorus Level)

## ■ Effect Type List

### ● Harmony Types

No.	Harmony Type	Description
01	Duet	Harmony types 01 – 05 are pitch-based and add one-, two- or three-note harmonies to the single-note melody played in the right hand. These types only sound when chords are played in the auto accompaniment area of the keyboard.
02	Trio	
03	Block	
04	Country	
05	Octave	
06	Trill 1/4 note	<p>Types 6 – 26 are rhythm-based effects and add embellishments or delayed repeats in time with the auto accompaniment. These types sound whether the auto accompaniment is on or not; however, the actual speed of the effect depends on the Tempo setting (page 20). The individual note values in each type let you synchronize the effect precisely to the rhythm. Triplet settings are also available: 1/6 = quarter-note triplets, 1/12 = eighth-note triplets, 1/24 = sixteenth-note triplets.</p> <ul style="list-style-type: none"> <li>• The Trill effect Types (06 – 12) create two-note trills (alternating notes) when two notes are held.</li> <li>• The Tremolo effect Types (13 – 19) repeat all held notes (up to four).</li> <li>• The Echo effect Types (20 – 26) create delayed repeats of each note played.</li> </ul>
07	Trill 1/6 note	
08	Trill 1/8 note	
09	Trill 1/12 note	
10	Trill 1/16 note	
11	Trill 1/24 note	
12	Trill 1/32 note	
13	Tremolo 1/4 note	
14	Tremolo 1/6 note	
15	Tremolo 1/8 note	
16	Tremolo 1/12 note	
17	Tremolo 1/16 note	
18	Tremolo 1/24 note	
19	Tremolo 1/32 note	
20	Echo 1/4 note	
21	Echo 1/6 note	
22	Echo 1/8 note	
23	Echo 1/12 note	
24	Echo 1/16 note	
25	Echo 1/24 note	
26	Echo 1/32 note	

### ● Reverb Types

No.	Reverb Type	Description
01 – 03	Hall 1 – 3	Concert hall reverb.
04 – 05	Room 1 – 2	Small room reverb.
06 – 07	Stage 1 – 2	Reverb for solo instruments.
08 – 09	Plate 1 – 2	Simulated steel plate reverb.
10	Off	No effect.

### ● Chorus Types

No.	Chorus Type	Description
01 – 02	Chorus 1 – 2	Conventional chorus program with rich, warm chorusing.
03 – 04	Flanger 1 – 2	Pronounced three-phase modulation with a slight metallic sound.
05	Off	No effect.



# Style Functions

In the section “Try out the Style” (page 30) of the Quick Guide, we introduced you to the basic operations of the auto accompaniment styles. Here, we’ll explain some interesting and useful ways of sounding the styles, and ways to adjust the accompaniment level and the chords.

## Sounding only the percussion

You can have just the percussion parts of the accompaniment play by pressing the [ACMP ON/OFF] button—so that auto accompaniment is OFF (the ACMP display is unlit)—and starting the style. Playing the keyboard sounds the Main Voice with no bass or chord sounds, even when playing in the auto accompaniment section of the keyboard.

### NOTE

- The explanations here are applicable only when the [STYLE] button is turned on.
- The special Pianist styles do not have any percussion parts.



## Stop Accompaniment function

When auto accompaniment is turned on (the ACMP display is lit) and Synchro Start is off (the [START/STOP] button does not flash), you can play chords in the left-hand (accompaniment) section of the keyboard with the style stopped, and still hear the accompaniment chord. In this condition — called “Stop Accompaniment” — any valid chord fingerings (page 48) are recognized and the chord root/type are shown in the LCD. Since the PSR-K1 properly recognizes the chord, you can also use the Harmony effect (page 44) without having to play back a style.

### NOTE

- The explanations here are applicable only when the [STYLE] button is turned on.

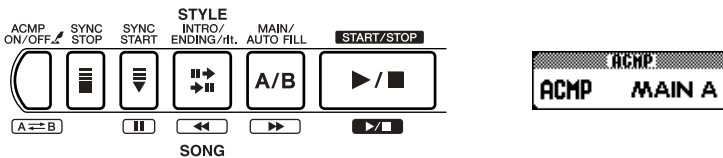

## Setting the Style Volume

- 1 Enter the FUNCTION display by pressing the [FUNCTION] button and call up the Style Volume page by using the CATEGORY buttons [▲]/[▼].
- 2 Set the style volume (range: 000 – 127).

### NOTE

- The explanations here are applicable only when the [STYLE] button is turned on.

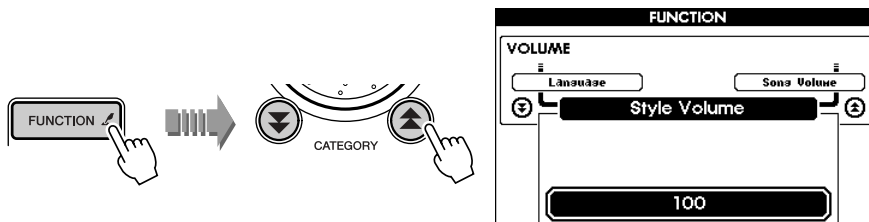

## Using external Style Files

Style number 136 is specially reserved for use with external Style Files, designated with the “.sty” file extension. Save the desired Style File to SmartMedia card using a computer (with an appropriate SmartMedia reader/writer) and load the Style File from the SmartMedia card to style number 136 on the instrument. For details, see page 63.

## Playing accompaniment chords

There are two basic ways of playing chords for the accompaniment: Single Finger and Fingered.

This instrument uses a sophisticated function called Multi Fingering, which automatically recognizes the chord played, no matter which way of fingering you use.

- Single Finger.....Simple chord indications
- Fingered .....Conventionally played chords

The key range left of the Split Point (default setting: 54 or F#2) is referred to as the auto accompaniment section of the keyboard. When using accompaniment, play the chords in this range.

**NOTE**

- The explanations here are applicable only when the [STYLE] button is turned on.

**NOTE**

- The Split Point can be changed. (See page 42.)

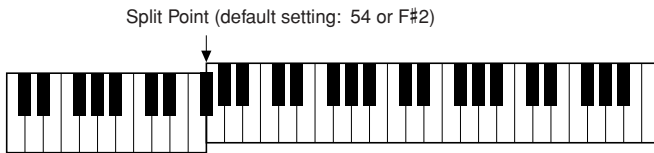

### ■ Single Finger

This method lets you easily play major, minor, seventh and minor seventh chords in the auto accompaniment section of the keyboard by using three fingers or less.

**NOTE**

- The illustration below shows the root names of the chords and their corresponding keys.

**● How to play Single Finger chords**

<p><b>C</b></p> <p>• To play a major chord Press the root note of the chord.</p>	<p><b>C7</b></p> <p>• To play a seventh chord Press the root note together with the nearest white key to the left of it.</p>
<p><b>Cm</b></p> <p>• To play a minor chord Press the root note together with the nearest black key to the left of it.</p>	<p><b>Cm7</b></p> <p>• To play a minor seventh chord Press the root note together with the nearest white and black keys to the left of it (three keys altogether).</p>

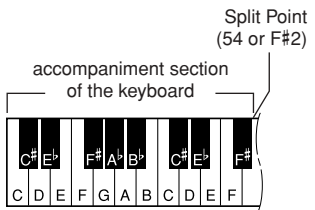

### ■ Fingered

This method lets you play chords normally within the auto accompaniment section of the keyboard, and the instrument plays the proper accompaniment.

**● How to play Fingered chords**  
[Example for "C" chords]

<b>C</b>	<b>C<sup>(9)</sup></b>	<b>C<sub>6</sub></b>	<b>C<sub>6</sub><sup>(9)</sup></b>	<b>CM7</b>	<b>CM<sub>7</sub><sup>(9)</sup></b>	<b>CM<sub>7</sub><sup>(#11)</sup></b>	<b>C<sup>(b5)</sup></b>	<b>CM<sub>7</sub><sup>(b5)</sup></b>
<b>Csus4</b>	<b>Caug</b>	<b>CM7aug</b>	<b>Cm</b>	<b>C<sub>m</sub><sup>(9)</sup></b>	<b>Cm6</b>	<b>Cm7</b>	<b>C<sub>m7</sub><sup>(9)</sup></b>	<b>C<sub>m7</sub><sup>(11)</sup></b>
<b>CmM7</b>	<b>C<sub>m7</sub><sup>(9)</sup></b>	<b>C<sub>m7</sub><sup>(b5)</sup></b>	<b>C<sub>m7</sub><sup>(b5)</sup></b>	<b>Cdim</b>	<b>Cdim7</b>	<b>C7</b>	<b>C<sub>7</sub><sup>(b9)</sup></b>	<b>C<sub>7</sub><sup>(b13)</sup></b>
<b>C<sub>7</sub><sup>(9)</sup></b>	<b>C<sub>7</sub><sup>(#11)</sup></b>	<b>C<sub>7</sub><sup>(13)</sup></b>	<b>C<sub>7</sub><sup>(#9)</sup></b>	<b>C<sub>7</sub><sup>(b5)</sup></b>	<b>C<sub>7</sub>aug</b>	<b>C<sub>7</sub>sus4</b>	<b>C<sub>7</sub>sus2</b>	

\* Notes enclosed in parentheses ( ) are optional; the chords will be recognized without them.



● **Fingered chords that are recognized**

Chord Name/[Abbreviation]	Normal Voicing	Chord (C)	Display
Major [M]	1 - 3 - 5	C	C
Add ninth [(9)]	1 - 2 - 3 - 5	C <sup>(9)</sup>	C9
Sixth [6]	1 - (3) - 5 - 6	C6	C6
Sixth ninth [6(9)]	1 - 2 - 3 - (5) - 6	C <sub>6</sub> <sup>(9)</sup>	C69 *
Major seventh [M7]	1 - 3 - (5) - 7 or 1 - (3) - 5 - 7	CM7	CM7
Major seventh ninth [M7(9)]	1 - 2 - 3 - (5) - 7	CM <sub>7</sub> <sup>(9)</sup>	CM7 <sup>9</sup> *
Major seventh add sharp eleventh [M7(#11)]	1 - (2) - 3 - #4 - 5 - 7 or 1 - 2 - 3 - #4 - (5) - 7	CM <sub>7</sub> <sup>(#11)</sup>	CM7#11 *
Flatted fifth [(b5)]	1 - 3 - b5	C <sup>(b5)</sup>	C <sup>b5</sup> *
Major seventh flatted fifth [M7b5]	1 - 3 - b5 - 7	CM <sub>7</sub> <sup>(b5)</sup>	CM7 <sup>b5</sup> *
Suspended fourth [sus4]	1 - 4 - 5	Csus4	Csus4
Augmented [aug]	1 - 3 - #5	Caug	Caug
Major seventh augmented [M7aug]	1 - (3) - #5 - 7	CM7aug	CM7aug *
Minor [m]	1 - b3 - 5	Cm	Cm
Minor add ninth [m(9)]	1 - 2 - b3 - 5	Cm <sup>(9)</sup>	Cm9
Minor sixth [m6]	1 - b3 - 5 - 6	Cm6	Cm6
Minor seventh [m7]	1 - b3 - (5) - b7	Cm7	Cm7
Minor seventh ninth [m7(9)]	1 - 2 - b3 - (5) - b7	Cm <sub>7</sub> <sup>(9)</sup>	Cm7 <sup>9</sup>
Minor seventh add eleventh [m7(11)]	1 - (2) - b3 - 4 - 5 - (b7)	Cm <sub>7</sub> <sup>(11)</sup>	Cm7 <sup>11</sup> *
Minor major seventh [mM7]	1 - b3 - (5) - 7	CmM7	CmM7
Minor major seventh ninth [mM7(9)]	1 - 2 - b3 - (5) - 7	CmM <sub>7</sub> <sup>(9)</sup>	CmM7 <sup>9</sup> *
Minor seventh flatted fifth [m7b5]	1 - b3 - b5 - b7	Cm <sub>7</sub> <sup>(b5)</sup>	Cm7 <sup>b5</sup>
Minor major seventh flatted fifth [mM7b5]	1 - b3 - b5 - 7	CmM <sub>7</sub> <sup>(b5)</sup>	CmM7 <sup>b5</sup> *
Diminished [dim]	1 - b3 - b5	Cdim	Cdim
Diminished seventh [dim7]	1 - b3 - b5 - 6	Cdim7	Cdim7
Seventh [7]	1 - 3 - (5) - b7 or 1 - (3) - 5 - b7	C7	C7
Seventh flatted ninth [7(b9)]	1 - b2 - 3 - (5) - b7	C <sub>7</sub> <sup>(b9)</sup>	C7 <sup>b9</sup>
Seventh add flatted thirteenth [7(b13)]	1 - 3 - 5 - b6 - b7	C <sub>7</sub> <sup>(b13)</sup>	C7 <sup>b13</sup>
Seventh ninth [7(9)]	1 - 2 - 3 - (5) - b7	C <sub>7</sub> <sup>(9)</sup>	C7 <sup>9</sup>
Seventh add sharp eleventh [7(#11)]	1 - (2) - 3 - #4 - 5 - b7 or 1 - 2 - 3 - #4 - (5) - b7	C <sub>7</sub> <sup>(#11)</sup>	C7#11
Seventh add thirteenth [7(13)]	1 - 3 - (5) - 6 - b7	C <sub>7</sub> <sup>(13)</sup>	C7 <sup>13</sup>
Seventh sharp ninth [7(#9)]	1 - #2 - 3 - (5) - b7	C <sub>7</sub> <sup>(#9)</sup>	C7#9
Seventh flatted fifth [7b5]	1 - 3 - b5 - b7	C7 <sup>b5</sup>	C7 <sup>b5</sup> *
Seventh augmented [7aug]	1 - 3 - #5 - b7	C7aug	C7aug
Seventh suspended fourth [7sus4]	1 - 4 - (5) - b7	C7sus4	C7sus4
Suspended second [sus2]	1 - 2 - 5	Csus2	Csus2 *

\* These chords are not shown in the Dictionary function.

**NOTE**

- Notes in parentheses can be omitted.
- Playing two same root keys in the adjacent octaves produces accompaniment based only on the root.
- A perfect fifth (1 + 5) produces accompaniment based only on the root and fifth which can be used with both major and minor chords.
- The chord fingerings listed are all in “root” position, but other inversions can be used — with the following exceptions:  
m7, m7<sup>b5</sup>, 6, m6, sus4, aug, dim7, 7<sup>b5</sup>, 6(9), sus2.
- Inversion of the 7sus4 and m7(11) chords are not recognized if the notes shown in parentheses are omitted.
- The auto accompaniment will sometimes not change when related chords are played in sequence (e.g. some minor chords followed by the minor seventh).
- Two-note fingerings will produce a chord based on the previously played chord.
- It may occur that the chord name indication shown in the MAIN display may not match that of the song data, even though the actual note/chord is the same. For example, a C# chord may actually be indicated as Db.

## Dictionary

The Dictionary function is essentially a built-in “chord book” that shows you the individual notes of chords. It is ideal when you know the name of a certain chord and want to quickly learn how to play it.

- 1 Press the [DICTIONARY] button. The Dictionary display appears.

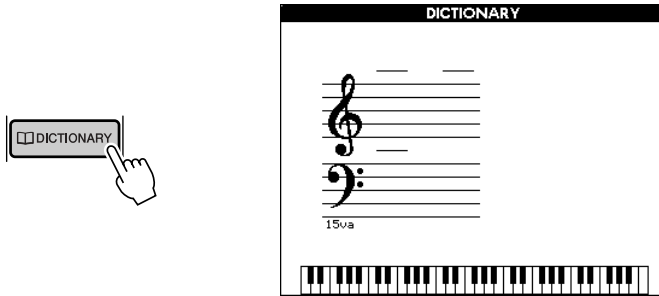

- 2 As an example, we'll learn how to play a GM7 (G major seventh) chord. Press the “G” key in the section of the keyboard labeled “CHORD ROOT.” (The note doesn't sound.) The root note you set is shown in the display.

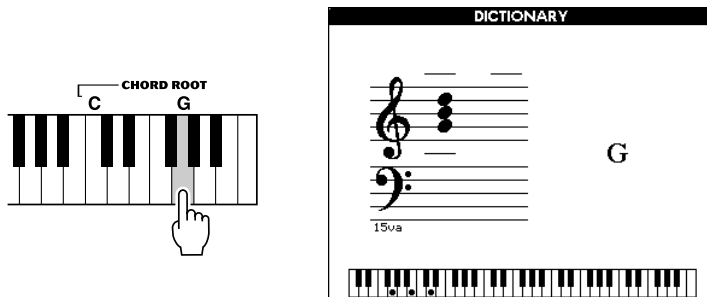

- 3 Press the “M7” (major seventh) key in the section of the keyboard labeled “CHORD TYPE.” (The note doesn't sound.) The notes you should play for the specified chord (root note and chord type) is shown in the display, both as notation and in the keyboard diagram.

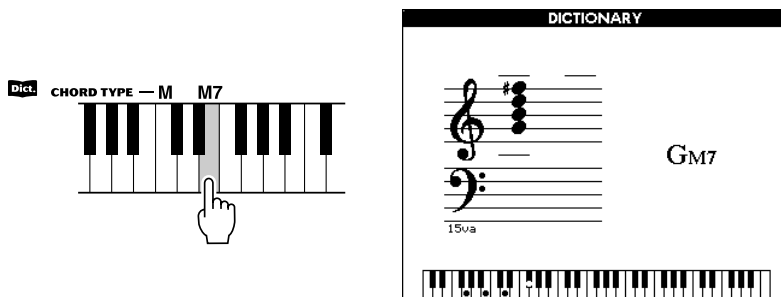

**NOTE**

• About major chords :  
Simple major chords are usually indicated only by the root note. For example, “C” refers to C major. However, when specifying major chords here, make sure to select “M” (major) after pressing the root note.

To call up possible inversions of the chord, press the [+]/[-] buttons.

- 4 Try playing a chord in the auto accompaniment section of the keyboard, checking the indications in the display. When you've played the chord properly, a bell sound signals your success and the chord name in the display is highlighted.

## ■ About chords

Playing two or more notes together simultaneously creates a “chord.”

Playing a note together with two other notes spaced three notes (steps) apart — such as the notes C, E and G — creates a harmonious sound. Chords like these are called “triads” and they play an important role in most music.

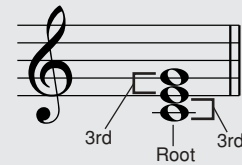

Taking the chord above as an example, the lowest note of this triad is called the “root note.” This is the central note sound, and it supports or anchors the rest of the notes chord.

You’ll notice that the middle note of the chord above (E) is the third step in the succession of scale notes — C, D, then E. There are two types of “thirds” in chords: major thirds and minor thirds.

Major third — four half steps from the root

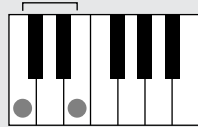

Minor third — three half steps from the root

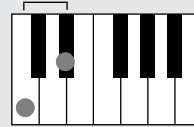

We’ll also alter the top note of our original chord and make three additional chords, as shown below. (The captions indicate the intervals between each of the notes.)

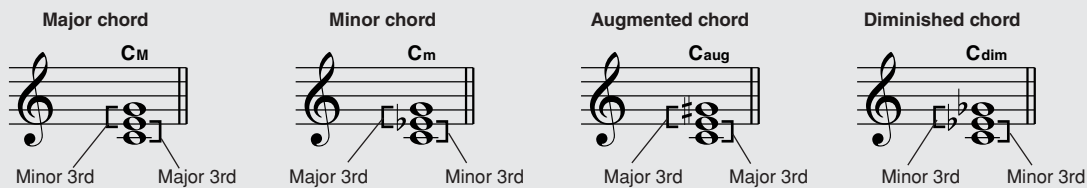

The basic characteristics of the chord sound are same, no matter if we change the order of the notes from bottom to top, or if we add other same name notes in different octaves. Beautiful sounding harmonies can be built in this manner, and emotional music can be created by playing different chords one after the other according to commonly accepted rules. Harmony determines the nature of chords, and music is created based on harmony.

## ● Chord names

From the chord name, you can tell at a glance what type of chord it is and which notes make up the chord. Understanding the basic structure of chords is very useful—once you’re familiar with this, you’ll be quickly and easily play chords by looking at the names that appear above the notation.

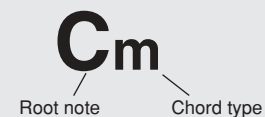

## ● Chord types (These chords are among those that can be recognized by the Fingered method.)

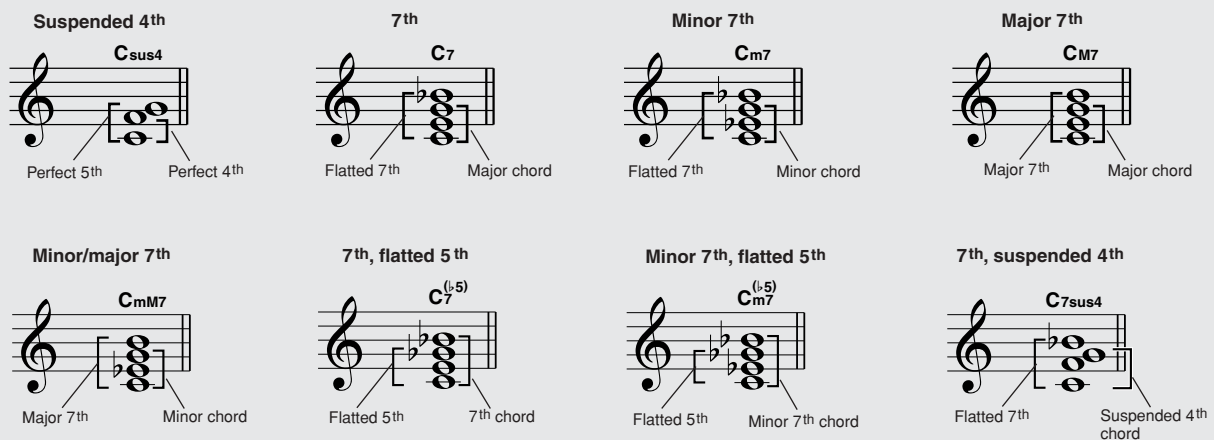



# Memorizing your panel settings

This instrument has a special Registration Memory feature that lets you save your custom panel settings—up to sixteen sets (eight banks of two each). These Registration Memory sets include selection of voices and accompaniment styles from both internal memory and SmartMedia card, and they can be called up any time you need them.

## Creating (saving) Registration Memory settings

### ■ Settings that can be saved to Registration Memory

- Style settings\* .....Style number, Auto Accompaniment ON/OFF, Split Point, Style settings (Main A/B), Style Volume, Tempo
- Voice settings .....Main Voice setting (Voice number, Volume, Octave, Pan, Reverb Send Level, Chorus Send Level), Dual Voice settings (Dual ON/OFF, Voice number, Volume, Octave, Pan, Reverb Send Level, Chorus Send Level), Split Voice settings (Split ON/OFF, Split Point, Voice number, Volume, Octave, Pan, Reverb Send Level, Chorus Send Level)
- Effect settings .....Reverb Type, Chorus Type
- Harmony settings .....Harmony ON/OFF, Harmony Type, Harmony Volume
- Other settings .....Transpose, Microphone Volume, Microphone Echo

\* Style settings are not available for Registration Memory when using the Song features.

### ■ Make sure to use a SmartMedia card

Keep in mind that the Registration Memory data on internal memory will be lost when the power is turned off. However, if you've inserted a SmartMedia card to the CARD slot, the Registration Memory data is automatically saved to the SmartMedia card as the file "PSR-K1.ENV" whenever memorizing the panel settings to any of the REGISTRATION MEMORY buttons. If the appropriate SmartMedia card is inserted, the next time you turn on the power, the instrument automatically loads the Registration Memory data from the SmartMedia to internal memory.

Because of this, you should always make sure to insert a SmartMedia card to the CARD slot before turning the power on (page 12).

#### NOTE

- If no SmartMedia card is inserted or if the SmartMedia card contains no Registration Memory data, turning the power on will reset the Registration Memory of the instrument to its original, blank condition.

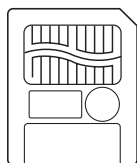

### ■ Creating a Registration Memory setting

- 1 Setup the panel controls as desired—selecting desired the voices, accompaniment style, etc.
- 2 Press the [BANK] button to call up the Registration Memory bank number and select the bank (1 – 8) for storing your settings by using the dial or the numeric keypad (buttons [0] – [9], [+]/[-]).

#### NOTE

- Registration Memory settings cannot be saved during song playback.

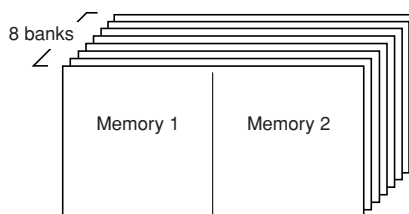
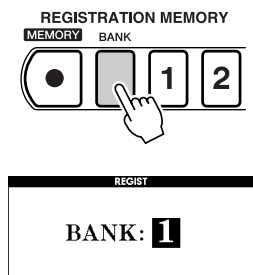

Up to 16 presets (eight banks of two each) can be memorized.

- 3 Simultaneously hold down the [MEMORY] button and press the appropriate REGISTRATION MEMORY button ([1] or [2]). The current panel settings are now stored both to internal memory and also to the inserted SmartMedia card.

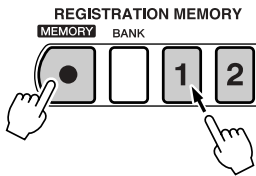

**CAUTION**

- If you select a Registration Memory setting that has already been created, the previous data is deleted and overwritten with the new data.
- The Registration Memory data saved to the SmartMedia card is automatically given the same file name "PSR-K1.ENV"; saving new data always overwrites and deletes the previous data.

- 4 If desired, you can save the Registration Memory data to a user-specified file (other than "PSR-K1.ENV") in a SmartMedia card by using the FILE CONTROL function (page 63).

■ **Calling up Registration Memory settings**

- 1 Press the [BANK] button to call up the bank numbers and select the desired bank (1 – 8) by using the dial or the numeric keypad (buttons [0] – [9], [+]/[-]).



- 2 Press the appropriate REGISTRATION MEMORY button ([1] or [2]) which has the desired data. The panel controls are now reconfigured to the stored settings.





# Song playback functions

In the Quick Guide, we introduced you to the basic song-related operations, such as Karaoke, performance assistant, and the Lesson features. Here, we'll show you how to load and call up external songs, and how to play back the song together with a style.

## Song types

The songs of this instrument are organized into the following types.

- 001 – 100 : These contain the preset songs, including pop songs and piano pieces.
- 101 – 105 : These are the number locations to which you save the original songs you've recorded (User songs). For details on recording, see page 59. You will need to save your important User song data to SmartMedia card, since User song data is automatically lost when the power is turned off. (See page 63.)
- 106 – 999 : These are the number locations for SmartMedia card songs. When song files exist in a SmartMedia card, the songs are assigned in order, starting with 106. A maximum of 894 songs can be stored to SmartMedia card (up to #999). This instrument is compatible with Standard MIDI File (SMF) data of either Format 0 or 1. You can also download songs from the Internet and save them to SmartMedia card for use on this instrument. (See page 70.)

### CAUTION

- When you wish to select and play a song in the SmartMedia card (song #106 or higher), make sure to insert the appropriate SmartMedia to the CARD slot before turning the power on.

#### ● SMF (Standard MIDI File)

This is the most common sequence format. Standard MIDI Files are generally available as one of two types: Format 0 or Format 1. Many MIDI devices are compatible with Format 0, and most commercially available software is recorded as Format 0. The instrument is compatible with both Format 0 and Format 1. Song data recorded on the instrument is automatically recorded as SMF Format 0.

## Displaying Lyrics

- For song data containing lyrics data (XF format or SMF songs containing lyric data), you can have the lyrics shown in the display during song playback by pressing the [KARAOKE] button.
- If the song file contains chord data, the chords can also be shown.
- If there is no language setting in the song data, the language (Japanese or English) of the displayed lyrics will match that of the Language setting in the FUNCTION display (page 79). If you play back a song containing Japanese lyrics when the display setting is set to English, ghost letters will be created.

## Displaying Notation (sheet music)

- During song playback, you can have the music notation shown in the display by pressing the [SCORE] button.
- There are two types of music sheet display; melody notation and the piano-style notation, and you can toggle between the two types by the pressing the [SCORE] button.
- If the song file includes chord and lyrics data, both the chord and lyrics are displayed (when using the melody notation).
- For song files on SmartMedia card song (106 – 999)(SMF, Format 0/1), only the tracks which are assigned to the right-hand part (R-part) and the left-hand part (L-part) in the FUNCTION display (page 79), are shown as notation in the display.
- Notation cannot be displayed for the User songs (101 – 105). However, if you convert the songs to Standard MIDI File format and store them to SmartMedia card (page 64), the notation can be displayed.
- If the notation in the display becomes difficult to read because of too many notes and rests, you may be able to clean up the notation from the Quantize page in the FUNCTION display. (See page 79.)
- If the song lyrics contain a lot of words in a few measures, some of the words may be omitted in the display. If you want to make sure to be able to see all the lyrics, use the Karaoke display (press the [KARAOKE] button).
- The displayed music notation is created based on the song data. For this reason, the notation of songs with complicated parts or data containing many notes of short duration may not appear the same as commercially available transcriptions. For example:
  - \* Embellishments and grace notes may not be clearly displayed.
  - \* The notation may show the correct note but with the wrong name. (For example, the note G# may be displayed where A♭ should actually be shown.)
  - \* If a new note plays in addition to others currently being held (or tied, in the notation), the actual duration of the earlier notes may not be displayed properly.

### Melody notation

### Piano-style notation

## Song Lesson

- User songs (101 – 105) cannot be directly selected for the Song Lesson features. However, if you convert the songs to Standard MIDI File format and store them to SmartMedia card (page 64), they can be used with Song Lesson.
- The Split Point is fixed during the Song Lesson.
- The left-hand and right-hand areas of the keyboard are fixed for the Song Lesson.
- Track ON/OFF cannot be changed while the Song Lesson is used.

## Setting the song volume

- 1 Enter the FUNCTION display by pressing the [FUNCTION] button and call up the Song Volume page by using the CATEGORY buttons [▲]/[▼].
- 2 Set the Song Volume (range: 000 – 127).

### NOTE

- This can be set when the style is selected.

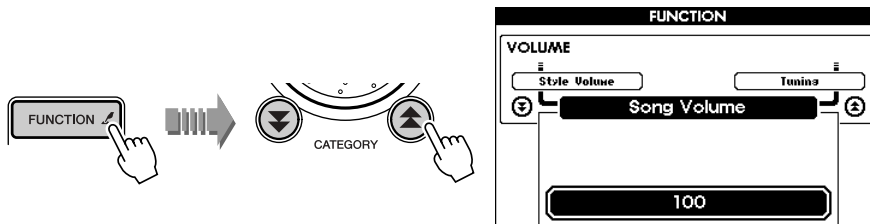

## Changing the melody voice of the song

Even though the song has a certain voice assigned for the melody, you can change this to any voice you want. The melody voices can be set independently for the right-hand performance (MELODY R) and left-hand performance (MELODY L).

- 1 Press and hold the [VOICE] button until the Dual Voice Select display appears.
- 2 Then press [VOICE] repeatedly until “MELODY R” (or “MELODY L”) appears at the top.
- 3 Select the desired voice’s number and name.

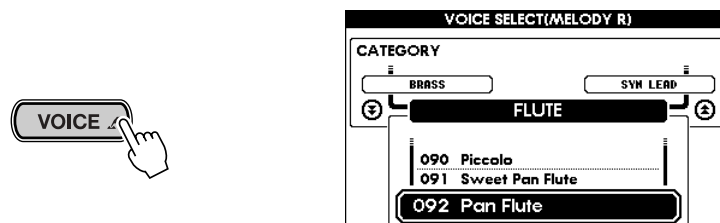

## Listen repeatedly to a section of the song

You can repeatedly play back any section of a song, specifying the beginning and end points for the section (A and B).



- 1 Play back the song and press the [A ↔ B] button at the point you want the repeat to start (A).



SCORE Can't Help Falling In Love  
 TEMPO J=069 TRANSPOSE 0 (A=B) MEASURE 005  
 Cm Cm/Bb Ab Eb/G  
 say only fools rush

**NOTE**

- The repeat function can be set only at measure boundaries. A repeat cannot be started or ended in the middle of a measure.
- If you want to have the beginning of the song as the start point (A) for the repeat, press the [A ↔ B] button BEFORE starting the song.

- 2 Press the [A ↔ B] button again at the end of the repeat (B). The song plays back repeatedly between the A and B points.



SCORE Can't Help Falling In Love  
 TEMPO J=069 TRANSPOSE 0 (A=B) MEASURE 012  
 Cm Cm/Bb Ab Eb/G  
 stay? Wouldit be a

To cancel the repeat and the set points, simply press the [A ↔ B] button while the section is repeating.

## Song track structure

The various parts of the songs are divided into different tracks, each playing a separate part of the performance—melody, percussion, accompaniment, etc.

You can mute the part on an individual track and play that part by yourself, or single out certain tracks that you want to listen to.

To turn a track on or off, use the buttons in the SONG MEMORY section: [1] – [5], [A].

Playback of the track is muted when the track is set to off, and the box around the track number goes out.

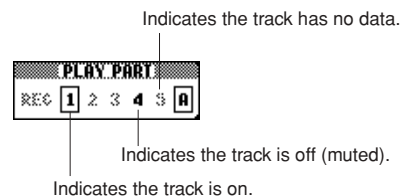

Song tracks are organized as follows.

- Tracks [1] – [5] .....Track 1 contains the melody of the right hand performance (MELODY R), and Track 2 contains the melody of the left hand performance (MELODY L). Tracks 3 – 5 contain a variety of backing parts, depending on the selected song.
- Track [A].....Contains the accompaniment part.





# Making your own song arrangements

## (Easy Song Arranger)

Easy Song Arranger is an exciting new feature that lets you easily change the feel of a song by applying your favorite accompaniment styles.

For example, you could spice up a ballad by giving it a house arrangement, or transform a jazz standard into a hip-hop tune. Naturally, you can also have the lyrics displayed.

### About Easy Song Arranger

- Easy Song Arranger automatically plays the accompaniment by reading the chords in the song data and translating that into chord data for the accompaniment features. The Melody Left and Right parts of the song play from Tracks 1 and 2.
- Both the song and accompaniment play simultaneously while Easy Song Arranger is used.
- When the time signature (beat) of the accompaniment does not match that of the song, the time signature of the song takes precedence.
- The voices used for your keyboard performance and the melody of the song can be freely changed from the MAIN, MELODY L and MELODY R settings in the VOICE section.
- The Easy Song Arranger settings (Style Number, Melody Voice) can be saved to SmartMedia card.
- Channels 1 - 5 are assigned to Tracks 1 - 5, respectively. Channels 6 - 8 are assigned to Track A, and channels 9 - 16 are not used (ignored). For the initial settings, Tracks 1 and 2 are set to ON, while Tracks 3 - 5 and A are set to OFF (muted).

#### NOTE

- Only the song data is used for chord recognition; as a result, accompaniment does not change when you play keys in the accompaniment section of the keyboard. The [ACMP ON/OFF] button does not function, either.
- Easy Song Arranger cannot be used with the User songs (101 - 105). However, if you convert the songs to Standard MIDI File format and store them to SmartMedia card (page 64), the feature can be used.

### Using Easy Song Arranger

#### ■ Selecting a song

- 1 Call up the Easy Song Arranger MAIN display by pressing the [EASY SONG ARRANGER] button. The SONG row is highlighted.



- 2 Call up the Song List by holding down the [EASY SONG ARRANGER] button.

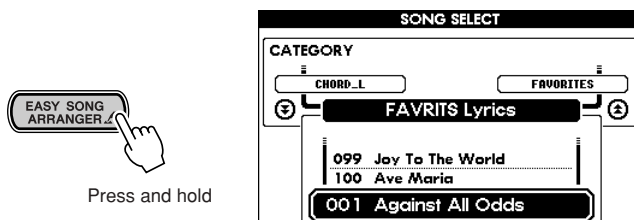

- 3 Select the desired song.

#### ■ Selecting the accompaniment style

- 1 To call up the Style List, press the [EASY SONG ARRANGER] button while the Song List (above) is displayed.

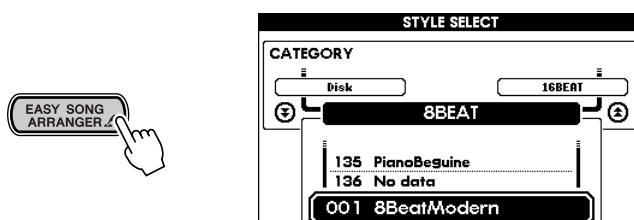

- 2 Select the desired style.

#### NOTE

- The STYLE row is highlighted when pressing the [EASY SONG ARRANGER] button in the Easy Song Arranger MAIN display.

## ■ Selecting Voices

- 1 From the Easy Song Arranger MAIN display, press the [VOICE] button.

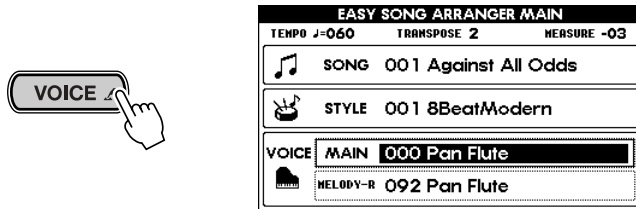

- 2 Press and hold the [VOICE] button until the Voice Select display appears.

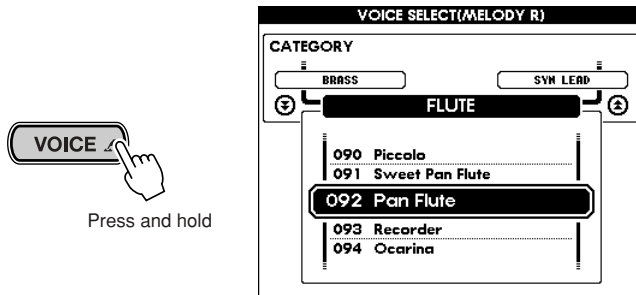

- 3 Press the [VOICE] button repeatedly to step through the various voice categories.
- 4 Select the desired voice.

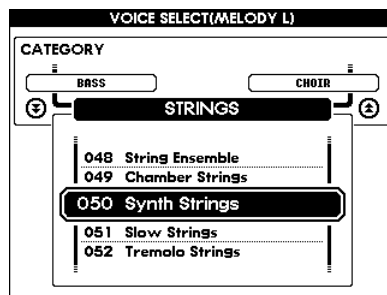

## ■ Playing back the song with Easy Song Arranger

Playback of the newly arranged song is done in the same way as normal. Press the [START/STOP] button, and the song plays back with the newly selected style and voices.

## ■ Saving your custom Easy Song Arranger settings

To save the currently selected settings of the Easy Song Arranger to SmartMedia card, simultaneously hold down the [EASY SONG ARRANGER] button and press the [FILE CONTROL] button.

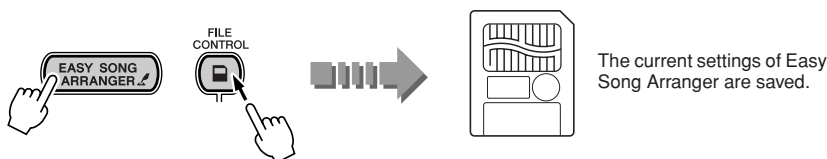

### NOTE

- Saving Easy Song Arranger settings only applies to SmartMedia card songs used with Easy Song Arranger.



# Recording your performances

The powerful recording features let you record your own performances and original songs and save them as User songs (songs #101 – 105). Naturally, these can be played back the same as the preset songs.

## Recording

- You can record your keyboard performance in real time, just as if you were recording to a tape recorder.
- Each song has a total of six independent tracks available for recording—five melody tracks and one accompaniment (chord play) track.
- You can record your keyboard performances to the User songs (#101 – 105). You should save your User songs permanently to SmartMedia card (page 63), since User song data is lost when the power is turned off.
- The notation for User Songs (#101 – 105) cannot be directly displayed. However, you can have the notation displayed by converting the songs to Standard MIDI File format and saving them to a SmartMedia card. (See page 64.)

### ■ Data that can be recorded

#### ● Data that can be recorded to the melody tracks [1] – [5]

- Note ON/OFF (playing/releasing the key)
- Velocity (strength of playing the key)
- Voice Number
- Reverb Type\*
- Chorus Type\*
- Harmony Type ON/OFF
- Sustain ON/OFF
- Tempo\*/Beat\* (effective only when the accompaniment track is not recorded)
- Performance assistant ON/OFF

#### ● Data which can be recorded to the accompaniment track [A]

- Chord changes and timing
- Style Pattern changes
- Style Number\*
- Reverb Type\*
- Chorus Type\*
- Tempo
- Beat\*

Data marked with an asterisk (\*) is recorded at the beginning of the song. Any changes to these types of data in the middle of the song are not recorded.

#### ⚠ CAUTION

- Keep in mind that any song data recorded to internal memory will be lost when the power is turned off. However, if you've inserted a SmartMedia card to the CARD slot, the recorded song data can be saved to the SmartMedia card (page 63) after recording. Because of this, make sure to insert a SmartMedia card to the CARD slot before turning the power on (page 12).
- Keep in mind that when battery power becomes low, the instrument sounds may revert to their initial settings and the User song data and panel settings may be lost, especially if you play the instrument in this condition at a high volume. If you intend on using batteries, make sure to save your data regularly and often to a SmartMedia card.

#### NOTE

- **Song Memory Capacity**
  - Maximum number of notes : approximately 10,000 (when only "melody" tracks are recorded)
  - Maximum number of chords : approximately 5,500 (when only the chord track is recorded)

## Recording a song

- 1 Select the desired User song number (101 – 105) for recording in the MAIN display.

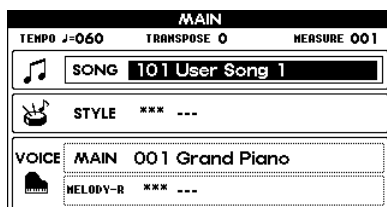

2 Check the tracks shown in the display and select the track to be recorded.

● **When simultaneously recording both a melody track and the accompaniment track**

Simultaneously hold down the [REC] button and press the desired button ([1] – [5]) for the melody track. Continue holding down [REC] and press the [A] button for the accompaniment track. The selected tracks are indicated as ON in the display.

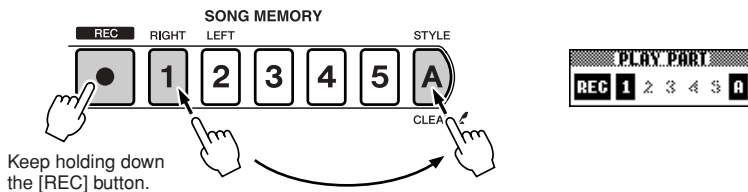

**CAUTION**

- If you record to a track that already contains recorded data, all previous data in the track is erased and replaced by your new recording.

**NOTE**

- If you select the accompaniment track [A] for recording, the accompaniment automatically is set to ON.
- You cannot turn accompaniment on or off once recording is started.
- When using a Split Voice for recording, the voice assigned to the left of the split point cannot be recorded.

● **When recording a melody track**

Simultaneously hold down the [REC] button and select the desired track button [1] – [5] for recording. The selected track lights.

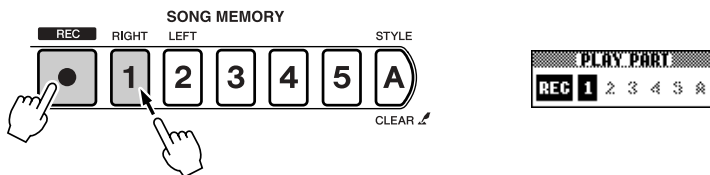

**NOTE**

- If the accompaniment track [A] has not yet been recorded and accompaniment is set to ON, when you select a melody track for recording, the accompaniment track [A] is automatically selected for recording as well. If you want to record only the melody, turn off the accompaniment track [A].
- To cancel recording for a track, press the same track button again. Keep in mind that accompaniment cannot be turned on/off after recording has started.

3 Recording starts as soon as you play the keyboard. You can also start recording by pressing the [START/STOP] button. The current measure number is shown in the display during recording.

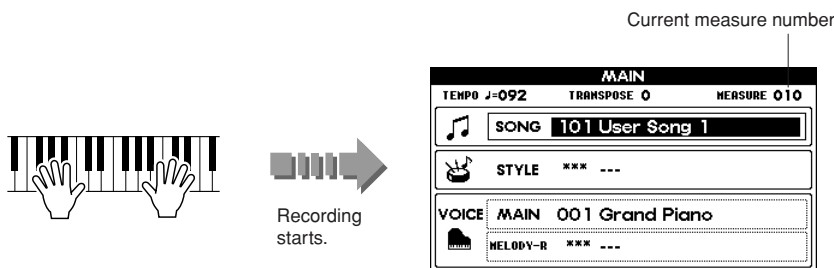

**NOTE**

- If memory becomes full during the recording, a warning message appears and recording is stopped. Try recording again after increasing the available memory by using the Song Clear (page 61) or Track Clear (page 61) functions.

4 Stop recording by pressing the [START/STOP] button or the [REC] button.

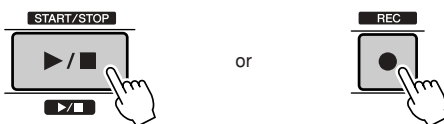

**CAUTION**

- Since all recorded song data is lost when turning off the power, make sure to save the song data to a SmartMedia card (page 63) after finishing recording.

If you press the [INTRO/ENDING/rit.] button while recording the accompaniment track, an appropriate ending phrase for your song is also recorded before the song stops.

When recording is finished, the measure number in the display returns to “001,” and the indicator of the recorded track lights.

### ● Recording additional tracks

Try adding to your recording by repeating steps ② – ④ above.

You can record other tracks while playing back and listening to previously recorded tracks (the track numbers light) by pressing the appropriate SONG MEMORY [1] – [5], [A] buttons. Previously recorded tracks can also be muted as desired during recording (the track numbers are unlit).

### ● Re-recording a track

Select the desired track for re-recording as in normal recording.

When recording is started, the previously recorded data is automatically erased and replaced by the new data.

## Deleting a User song (Song Clear)

This operation deletes the entire data (all tracks) of a recorded User song.

- ① Select the number of the User song (101 – 105) to be deleted from the MAIN display.
- ② Simultaneously hold down both the SONG MEMORY [A] and [1] buttons until the “Clear User Song?” prompt appears.

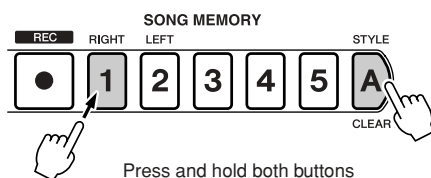

- ③ Press the [+] button.  
An “Are you sure?” message appears, asking if you want to delete the data.
- ④ Press the [+] button again to delete the data.  
A “Clearing” message appears in the display indicating the selected song is deleted.

#### NOTE

- To delete only one individual track of a song, use the Track Clear operation (page 61).

#### NOTE

- To cancel the operation, press the [-] button in Step ③.

#### CAUTION

- If you've deleted one or more specific songs but kept others, make sure to save the edited song data to a SmartMedia card (page 63) after performing the delete operation.

## Deleting a single track of a User song (Track Clear)

This operation lets you delete the data of a single, selected track in a User song.

- ① Select the number of the User song (101 – 105) containing the track to be deleted from the MAIN display.
- ② Hold down the SONG MEMORY button of the track you wish to delete until the “Clear Track?” prompt appears.



- ③ Press the [+] button.  
An “Are you sure?” message appears, asking if you want to delete the data.
- ④ Press the [+] button again to delete the data.  
A “Clearing” message appears in the display indicating the selected track is deleted.

#### NOTE

- To cancel the operation, press the [-] button in Step ③.

#### CAUTION

- Since all song data is lost when turning off the power, make sure to save the edited song data to a SmartMedia card (page 63) after clearing a track.



# SmartMedia card file operations

This section describes how to save, load and delete SmartMedia card data, as well as format SmartMedia cards for use with the instrument.

\* This instrument uses SmartMedia™ (3.3V) memory cards.

## **CAUTION**

- Make sure to insert an appropriate SmartMedia card in the card slot BEFORE you turn on the power. Never insert or pull out the SmartMedia card while the power is turned on. Doing so may damage the files in the SmartMedia card or data in the internal memory.

## About the SmartMedia card file operations

Call up the file operations and the FILE CONTROL display by pressing the [FILE CONTROL] panel button.

- Turning the power on automatically mounts the SmartMedia card. We recommend that you always have a SmartMedia card ready for backing up important data.
- When the SmartMedia card is mounted, the file control icon in the MAIN display lights and the FILE CONTROL display can be called up.
- When the FILE CONTROL display is active, all panel controls unrelated to File operations cannot be used. The instrument cannot be played either.
- If you are using a SmartMedia card that has not been formatted for the instrument and you press the [FILE CONTROL] button, the Format page is automatically called up (after a brief “Please Format” prompt), letting you format the card. (The particular Format page called up here is the same as that described in step 2 in the section “Formatting a SmartMedia card” below.)

## **NOTE**

- The FILE CONTROL display cannot be called up when the SmartMedia card is not properly inserted (file control icon is off).
- The FILE CONTROL display cannot be called up when the SmartMedia card is being accessed or mounted, or during style/song playback, or while Lesson is used.

## **CAUTION**

- Keep in mind that when battery power becomes low, the instrument sounds may revert to their initial settings and the User song data and panel settings may be lost, especially if you play the instrument in this condition at a high volume. If you intend on using batteries, make sure to save your data regularly and often to a SmartMedia card.

## Formatting a SmartMedia card

If you’ve bought a new, blank SmartMedia card, you’ll need to format the card before you can use it with the instrument.

- 1 Make sure the SmartMedia card you wish to format is inserted, then press the [FILE CONTROL] button.
- 2 Call up the Format page by using the CATEGORY buttons [▲]/[▼].  
A “Format OK?” message appears, asking if you want to format the card.



## **CAUTION**

- Keep in mind that formatting a SmartMedia card containing data irretrievably deletes all data previously saved to card. Make sure that you do not delete any important data by formatting the card.

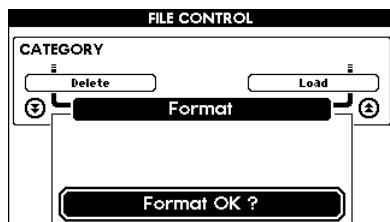

## **NOTE**

- If the write-protect function on the SmartMedia card is enabled, a “The media is write-protected.” message appears and the delete operation cannot be executed.

- 3 Press the [EXECUTE] button.  
A “Sure ?” message appears to confirm the operation.
- 4 Press the [EXECUTE] button or the [+] button to actually format the SmartMedia card.

## **CAUTION**

- You cannot cancel the operation while it is being executed (“Formatting...” message is shown). Never turn off the power or pull out the SmartMedia card in this condition.

## **NOTE**

- To cancel the operation, press the [-] button in Step 3.

- 5 When the Format operation is completed, a “Completed” message appears. To return to the MAIN display, press the [EXIT] button.

## File Load

This operation loads data of User files or style files on SmartMedia card to the internal memory.

- 1 With a SmartMedia card containing the files to be loaded inserted and press the [FILE CONTROL] button.
- 2 Call up the Load page by using the CATEGORY buttons [ $\blacktriangle$ ]/[ $\blacktriangledown$ ].

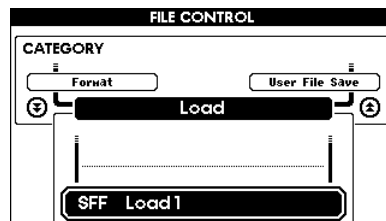

- 3 Select the desired file to be loaded.  
You can instantly jump to the first file (the lowest numbered file) in the list by simultaneously pressing both the [+] and [-] buttons.
- 4 Press the [EXECUTE] button.  
A “Load OK?” message appears, asking if you want to load the data.
- 5 Press the [EXECUTE] button or the [+] button to execute the operation.



### CAUTION

- You cannot cancel the operation while it is being executed (“Loading...” message is shown). Never turn off the power or pull out the SmartMedia card in this condition.

- 6 When the Load operation is completed, a “Completed” message appears.  
To return to the MAIN display, press the [EXIT] button.

### CAUTION

- When loading style files, data for internal style number 136 is overwritten and lost. Make sure to save important data to SmartMedia card before loading.

### NOTE

- Style File data must be in the root (top) directory and not inside a folder. Any Style File data inside a folder will not be found.

### NOTE

- If no files are contained in the SmartMedia card, a “File is not found” message appears and the load operation cannot be executed.

### NOTE

- To cancel the operation, press the [-] button in Step 4.

## Saving User data files

This operation lets you save your User songs (songs #101 – 105) and the User style (style #136) as well as your Registration Memory settings to SmartMedia card as a User data file.

- 1 With a formatted SmartMedia card inserted in the card slot and press the [FILE CONTROL] button.
- 2 Call up the User File Save page by using the CATEGORY buttons [ $\blacktriangle$ ]/[ $\blacktriangledown$ ].  
A file name is automatically assigned to the file you are saving here.

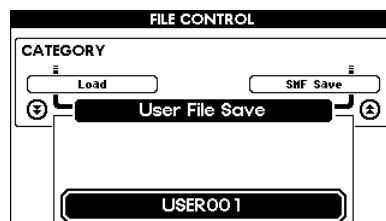

### Replacing (overwriting) an existing file

If you want to replace an existing User data file in the SmartMedia card with new data, select the appropriate file name with the dial or the [+] / [-] buttons, then go directly to step 4 below.

### NOTE

- If there is no User data to be saved, a “Save data is not found” message appears and the save operation cannot be executed.
- Up to 894 songs can be saved to a single SmartMedia card, irrespective of the data capacity.
- If the write-protect function on the SmartMedia card is enabled, a “The media is write-protected.” message appears and the save operation cannot be executed.
- If there is no available memory space on the SmartMedia card for saving the data, a “Memory capacity is full.” message appears and the save operation cannot be executed. To recover memory space for saving, delete any unnecessary files.
- Other messages than those described above may be shown. For a complete list of messages you may encounter while using SmartMedia cards, see page 82.

- 3 Press the [EXECUTE] button.  
The cursor appears under the first letter of the file name.  
If desired, change the file name.
  - Move the cursor left and right by using the [-] and [0] buttons.
  - Select the characters by using the dial.
  - Delete the character at the cursor by using the [+] button.

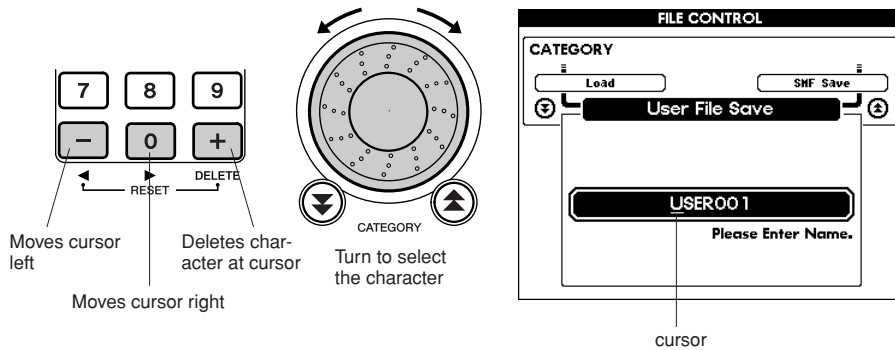

**NOTE**

• To cancel the operation, press the [-] button in Step 4.

**NOTE**

• If you've selected an existing file, an "Overwrite?" message appears, asking if you want to replace the file. To replace the file, press the [EXECUTE] button or [+] button. To cancel, press the [-] button.

**NOTE**

• The actual time needed to save data depends on the memory condition of the SmartMedia card (data fragmentation, etc.).

- 4 Press the [EXECUTE] button.  
A "Save OK?" message appears, asking if you want to save the data.
- 5 Press the [EXECUTE] button or the [+] button to execute the operation.

**CAUTION**

• You cannot cancel the operation while it is being executed ("Saving..." message is shown). Never turn off the power or pull out the SmartMedia card in this condition.

- 6 When the Save operation is completed, a "Completed" message appears.  
To return to the MAIN display, press the [EXIT] button.

## Save the User song as a Standard MIDI File

This operation converts the User songs (songs #101 –105) into SMF (Standard MIDI File) Format 0 data (see page 54), and saves them to the SmartMedia card.

- 1 With a formatted SmartMedia card inserted in the card slot and press the [FILE CONTROL] button.
- 2 Call up the SMF Save page by using the CATEGORY buttons [▲]/[▼].  
The Source File is highlighted and the User file name is displayed.

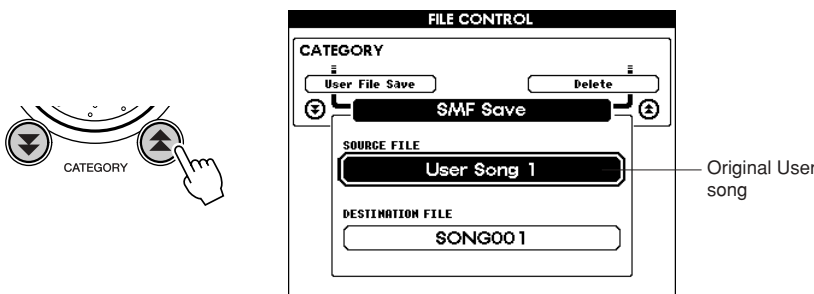

**NOTE**

• Up to 894 songs can be saved to a single SmartMedia card, irrespective of the data capacity.  
• If the selected song number contains no data, this operation cannot be executed.

- 3 Select the original User file name in the Source File row.  
You can instantly jump to the first User song (the lowest numbered song) in the list by simultaneously pressing both the [+] and [-] buttons.



- 4 Press the [EXECUTE] button.

The Destination File row is highlighted and the file name (automatically set) of the to-be-converted file is shown.

● **Replacing (overwriting) an existing file**

If you want to replace an existing User data file in the SmartMedia card with new data, select the appropriate file name with the dial or the [+]/[-] buttons, then go directly to step 6 below.

- 5 Press the [EXECUTE] button.

The cursor appears under the first letter of the file name.

If desired, change the file name. (For details on changing file names, refer to step 3 in the section “Saving User data files” on page 64.)

- 6 Press the [EXECUTE] button.

A “Save OK?” message appears, asking if you want to save the data.

- 7 Press the [EXECUTE] button or the [+] button to execute the operation.

**CAUTION**

- You cannot cancel the operation while it is being executed (“Saving...” message is shown). Never turn off the power or pull out the SmartMedia card in this condition.

- 8 When the Save operation is completed, a “Completed” message appears.

To return to the MAIN display, press the [EXIT] button.

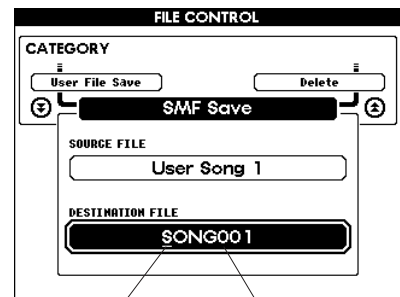

cursor

Destination file (song after conversion/saving)

**NOTE**

- If you've selected an existing file, an “Overwrite?” message appears, asking if you want to replace the file. To replace the file, press the [EXECUTE] button or [+] button. To cancel, press the [-] button.

**NOTE**

- To cancel the operation, press the [-] button in Step 6.

## Deleting User data files

This operation deletes User data files in the SmartMedia card.

- 1 With the SmartMedia card containing the file to be deleted inserted in the slot and press the [FILE CONTROL] button.

- 2 Call up the User Delete page by using the CATEGORY buttons [▲]/[▼].

- 3 Select the file to be deleted.

You can instantly jump to the first SmartMedia card song (the lowest numbered song) in the list by simultaneously pressing both the [+] and [-] buttons.

- 4 Press the [EXECUTE] button.

A “Delete OK?” message appears, asking if you want to delete the data.

- 5 Press the [EXECUTE] button or the [+] button to execute the operation.

**CAUTION**

- You cannot cancel the operation while it is being executed (“Deleting...” message is shown). Never turn off the power or pull out the SmartMedia card in this condition.

- 6 When the Delete operation is completed, a “Completed” message appears.

To return to the MAIN display, press the [EXIT] button.

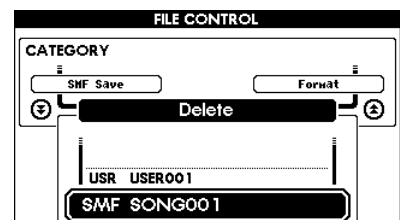

**NOTE**

- If the write-protect function on the SmartMedia card is enabled, a “The media is write-protected.” message appears and the delete operation cannot be executed.
- If no User files are contained in the SmartMedia card, a “File is not found.” message appears and the delete operation cannot be executed.

**NOTE**

- To cancel the operation, press the [-] button in Step 4.



# About MIDI

Nearly all of the electronic musical instruments made today—particularly synthesizers, sequencers and computer music related devices—use MIDI. MIDI is a world-wide standard that allows these devices to send and receive performance and setting data. Naturally, this instrument lets you save or send your keyboard performance as MIDI data, as well as that of the songs, styles and panel settings.

The potential MIDI holds for your live performance and music creation/production is enormous—simply by connecting this instrument to a computer and transmitting MIDI data. In this section, you'll learn the basics of MIDI and the particular MIDI functions of this instrument.

## What is MIDI?

No doubt you have heard the terms “acoustic instrument” and “digital instrument.” In the world today, these are the two main categories of instruments. Let's consider an acoustic piano and a classical guitar as representative acoustic instruments. They are easy to understand. With the piano, you strike a key, and a hammer inside hits some strings and plays a note. With the guitar, you directly pluck a string and the note sounds. But how does a digital instrument go about playing a note?

Acoustic guitar note production

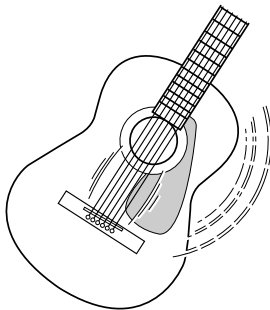

Pluck a string and the body resonates the sound.

Digital instrument note production

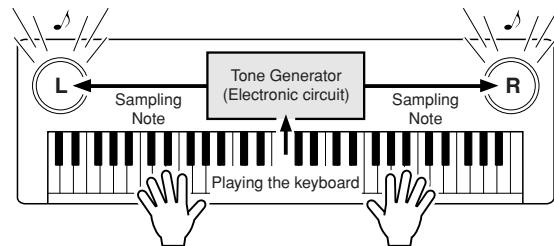

Based on playing information from the keyboard, a sampling note stored in the tone generator is played through the speakers.

As shown in the illustration above, in an electronic instrument the sampling note (previously recorded note) stored in the tone generator section (electronic circuit) is played based on information received from the keyboard. So then what is the information from the keyboard that becomes the basis for note production?

For example, let's say you play a “C” quarter note using the grand piano sound on the instrument. Unlike an acoustic instrument that puts out a resonated note, the electronic instrument puts out information from the keyboard such as “with what voice,” “with which key,” “about how strong,” “when was it pressed,” and “when was it released.” Then each piece of information is changed into a number value and sent to the tone generator. Using these numbers as a basis, the tone generator plays the stored sampling note.

### ● Example of Keyboard Information

Voice number (with what voice)	1 (grand piano)
Note number (with which key)	60 (C3)
Note on (when was it pressed) and note off (when was it released)	Timing expressed numerically (quarter note)
Velocity (about how strong)	120 (strong)

Your keyboard performance and all panel operations of this instrument are processed as MIDI data. The songs, auto accompaniment (styles), and User songs are also made up of MIDI data.

MIDI is an acronym that stands for Musical Instrument Digital Interface and it allows different musical instruments and devices to instantly communicate with each other, via digital data. The MIDI standard is used all over the world and was designed to transmit performance data between electronic musical instruments (or computers). Thanks to MIDI, you can control one instrument from another and transmit performance data between the devices-taking your creative and performance potential to even higher levels.

MIDI messages can be divided into two groups: Channel messages and System messages.

## ● Channel Messages

This instrument is capable of handling 16 MIDI channels simultaneously—meaning it can play up to sixteen different instruments at the same time. Channel messages transmit information such as Note ON/OFF, Program Change, for each of the 16 channels.

Message Name	Instrument Operation/Panel Setting
Note ON/OFF	Performance data of the keyboard (contains note number and velocity data)
Program Change	Instrument selection (including bank select MSB/LSB, if necessary)
Control Change	Instrument settings (volume, pan, etc.)

## ● System Messages

This is data that is used in common by the entire MIDI system. System messages include messages like Exclusive Messages that transmit data unique to each instrument manufacturer and Realtime Messages that control the MIDI device.

Message Name	Instrument Operation/Panel Setting
Exclusive Message	Reverb/chorus/DSP settings, etc.
Realtime Messages	Start/stop operation

The messages transmitted/received by the instrument are shown in the MIDI Implementation Chart on page 94.

## Connecting to a computer

Connecting this instrument to a computer enables a wide range of powerful and useful musical possibilities. You can transfer MIDI data back and forth with your computer for music recording/playback, and with the special Song Filer software (contained in the included CD-ROM), you can copy data from your computer to SmartMedia card.

Connect one end of a USB cable to the USB terminal on the rear panel of this instrument, and the other end to the USB terminal on your computer. You'll also need to install the USB-MIDI driver (also in the included CD-ROM) to your computer. For details, see the "Accessory CD-ROM Installation Guide" on page 71. (Keep in mind that Song Filer cannot be used to transmit data from the PSR-K1 to a computer. Also, when you download songs to SmartMedia card, make sure that the write-protect seal is not affixed to the card.)

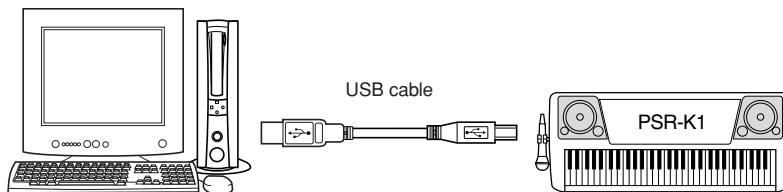

### NOTE

- You will not be able to access the instrument with Song Filer in the following situations:
  - When a style is playing
  - When a song is playing
  - From the File Control display
  - If a SmartMedia card is not inserted

### CAUTION

#### • Precautions concerning USB

**Do NOT turn the power on/off or connect/disconnect the USB cable in any of the following conditions. Doing so may cause the computer to hang up or freeze, stop the current operation or function in the musical instrument, and/or result in all data in the SmartMedia card being lost.**

- While the device is being recognized or while the driver is being loaded
- While the computer is in stand-by mode or hibernating
- While data is being transferred
- While starting or stopping the operating system
- While a MIDI application is operating

**Also, make sure to avoid the following. Problems such as those mentioned above may occur.**

- Turning the power on/off too often, or connecting/disconnecting the cable too frequently
- Changing to a power-save mode or resuming from stand-by while transferring MIDI data
- Connecting or disconnecting the cable while the power of the musical instrument is on
- Turning the power on or off, starting the computer, or installing the driver while data is being transferred

## MIDI settings

These settings determine how the instrument sends, receives and responds to MIDI data.

### ■ Local ON/OFF (Local)

This determines whether the internal tone generator sounds (ON) or not when you play the keyboard.

- ON (Local ON) ..... The normal performance condition; playing the keyboard plays the voices of the instrument.
- OFF (Local OFF) ..... In this condition, playing the keyboard has no effect on the voices, harmony or accompaniment of the instrument. However, your keyboard performance is transmitted as MIDI data via the USB connection, and the instrument responds to data received via the USB connection.

### NOTE

- If you can't get any sound out of the instrument, this may be the most likely cause. Playing the keyboard results in no sound when Local is set to OFF.

Local ON/OFF can be set from the Local page of the FUNCTION display. (See page 79.)

## ■ External Clock ON/OFF (External Clock)

This determines whether the instrument is synchronized to its own internal clock (OFF) or by an external clock signal (ON).

- ON (external clock).... Song and style playback synchronize to clock signals received from the external device connected to the USB terminal.
- OFF (internal clock).... Song and style playback synchronize to the internal clock (normal operation).

External Clock ON/OFF can be set from the External Clock page of the FUNCTION display. (See page 79.)

### NOTE

- If external clock is set to ON, songs and styles will not start unless external clock signals are received.

## ■ Initial Setup Send (Initial Send)

This function transmits the panel settings of this instrument to a computer.

This is particularly useful when recording to a sequencer, since it lets you record an initial setup message at the start of a song. In this way, when you play back the song, the instrument receives the message and automatically reconfigures the panel settings to those made when recording.

Initial Setup Send can be set from the Initial Send page of the FUNCTION display. (See page 79.)

## ■ Keyboard ON/OFF (KeyboardOut)

This determines whether performance data of the instrument's keyboard is sent via the USB connection (ON) or not.

Keyboard Out ON/OFF can be set from the KeyboardOut page of the FUNCTION display. (See page 79.)

## ■ Style Out ON/OFF (StyleOut)

This determines whether accompaniment style data of the instrument is sent via the USB connection (ON) or not, during style playback.

Style Out ON/OFF can be set from the StyleOut page of the FUNCTION display. (See page 79.)

### NOTE

- When SongOut (below) is set to ON, style data is always sent during song playback, even if StyleOut is set to OFF.

## ■ Song Out ON/OFF (SongOut)

This determines whether song data of the instrument is sent via the USB connection (ON) or not, during song playback.

Song Out ON/OFF can be set from the SongOut page of the FUNCTION display. (See page 79.)

### LSB Receive Cancel

This "hidden" function sets the instrument to ignore incoming bank select LSB messages.

To enable this function, simultaneously hold down the lowest C key on the keyboard and turn on the power with the [STANDBY/ON] switch.

This setting is temporary. The instrument returns to the original condition when the power is turned on again.

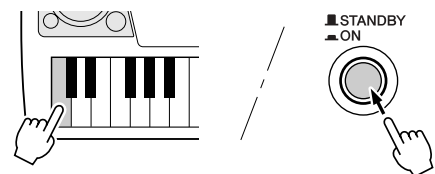

## MIDI settings for computer connections (PC Mode)

This convenient function lets you instantly reconfigure the instrument settings for use with a sequencer and computer. Simply press the [PC] button on the panel and turn the PC Mode ON, and the MIDI settings necessary for sequencer/computer operation are automatically set as shown below.

	PC Mode ON	PC Mode OFF
LOCAL	OFF	ON
External Clock	ON	OFF
KeyboardOut	OFF	ON
StyleOut	OFF	ON
SongOut	OFF	ON

### ■ PC Mode ON/OFF

- 1 Press the [PC] button to call up the PC Mode page in the FUNCTION display.
- 2 Turn PC Mode ON/OFF by using the [+]/[-] buttons.

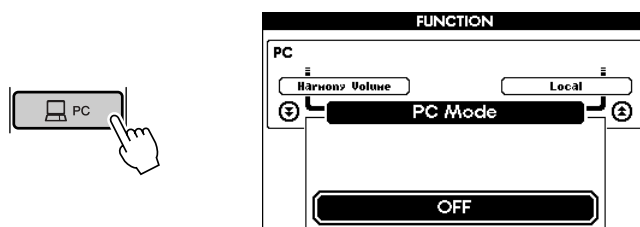

#### NOTE

- You can also select the PC Mode page from the FUNCTION display after pressing the [FUNCTION] button. (See page 77.)

## Remote control of MIDI devices

You can also use this instrument as a remote control device for the sequence software on your computer (via the USB connection)—controlling playback, stop and transport functions from the panel. (This feature may not be available depending on the particular device.)

### ■ Remote control keys

To use the remote control functions, simultaneously hold down the lowest two keys on the keyboard (C1 and C#1) and press the appropriate key (shown below).

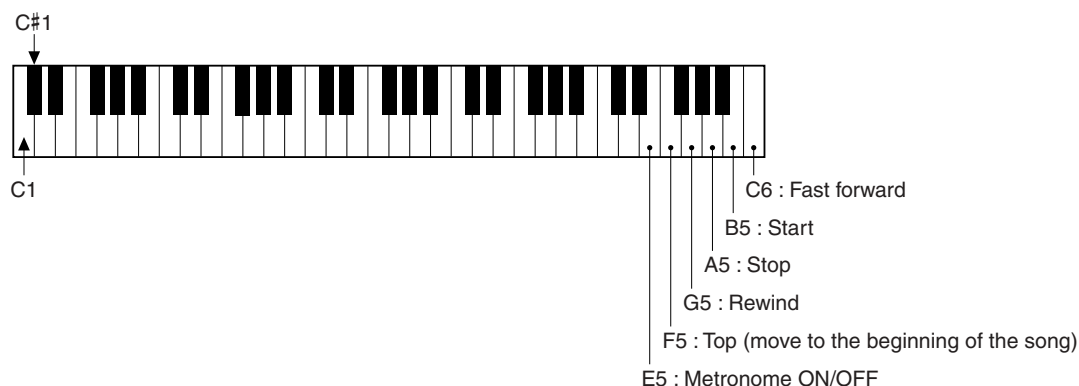

## Downloading song data

If you've downloaded song files from the Internet to your computer or used your computer to create your own songs, you can load them to this instrument and save them to SmartMedia card for future use. In this way, virtually any song file can be used with the versatile functions of the instrument—Karaoke, performance assistant, Easy Song Arranger and Lesson. In order to transfer song files between the instrument and a computer, you'll need to install both the Song Filer software and the USB-MIDI driver (contained in the included CD-ROM). For details on installing the software, see the "Accessory CD-ROM Installation Guide" on page 71. (Keep in mind that Song Filer cannot be used to transmit data from the PSR-K1 to a computer. Also, when you download songs to SmartMedia card, make sure that the write-protect seal is not affixed to the card.)

### Data transmission limitations

- Maximum number of songs : 894 (song numbers 106 – 999)
- Maximum amount of data : Depends on the capacity of the SmartMedia card
- Data format : SMF Format 0 (Format 1 files are automatically converted to Format 0.)

## ■ Using the Song Filer

- ➊ After installing Song Filer and the USB-MIDI driver to your computer, connect the instrument and computer with a USB cable. (See page 67.)
- ➋ Insert a SmartMedia card to the instrument and turn the power on.
- ➌ Start the Song Filer program on your computer.
- ➍ Song files (of SMF Format 0) contained in the SmartMedia card are shown in the display.

Song Filer allows you to transfer song files between your computer and the instrument, as well as manage your files on the instrument, deleting and renaming as needed.

For details on using Song Filer, refer to the electronic manual (PDF file) included with the software.

### CAUTION

- *Never attempt to turn the power off while transmitting data. Doing so will not only result in failure to save the data, but also make the SmartMedia card memory unstable and result in loss of all data in memory.*
- *Saved data in the instrument may be lost due to malfunction or incorrect operation. Make sure to save any important data to the computer.*
- *It is strongly suggested that you use the AC adaptor when executing data transfer operations. Low battery power during data transfer could result in damage or loss of the data.*

## Using downloaded songs with the Lesson and notation features

To use the Lesson features with songs you've downloaded, you'll need to specify beforehand which tracks are to be used as guides for the right- and left-hand parts. Do this from the R-part and L-part pages in the FUNCTION display (page 79).

The guide tracks set here will also be displayed in music notation (page 25).



# Accessory CD-ROM Installation Guide

## SPECIAL NOTICES

- The software and this Installation Guide are exclusive copyrights of Yamaha Corporation.
- Use of the software and this guide is governed by the SOFTWARE LICENSING AGREEMENT which the purchaser fully agrees to upon breaking the seal of the software packaging. (Please read carefully the AGREEMENT at the end of this guide before installing the application.)
- Copying of the software or reproduction of this guide in whole or in part by any means is expressly forbidden without the written consent of the manufacturer.
- Yamaha makes no representations or warranties with regard to the use of the software and documentation and cannot be held responsible for the results of the use of this guide and the software.
- This disc is a CD-ROM. Do not attempt to play the disc on an audio CD player. Doing so may result in irreparable damage to your audio CD player.
- Copying of the commercially available music data is strictly prohibited except for your personal use.
- The company names and product names in this Installation Guide are the trademarks or registered trademarks of their respective companies.
- Future upgrades of application and system software and any changes in specifications and functions will be announced separately.
- Depending on the version of your operating system, the screen shots and messages shown in this guide may differ to those that you see on your computer screen.

## Contents of CD-ROM

The applications in this CD-ROM are provided in versions for both Windows and Macintosh operating systems. The installation procedure and the applications themselves differ depending on the operating system that you are using.

### CAUTION

- **Never attempt to play back the included CD-ROM on an audio CD player. Doing so may result in damage to your hearing as well as to your CD player/audio speakers.**

### For Windows

Folder Name	Application/Data Name	Contents
SongFiler	Song Filer *1 *2	Enables downloading of song data from a computer to the instrument.
USBdrv_	USB Driver for Windows 98/Me	Enables communication between the MIDI instrument and your computer via a USB connection (for the indicated version of Windows).
USBdrv2k_	USB Driver for Windows 2000/XP	
SampleSongs	YMIA Introduction HTML	Enables you to take advantage (via the Internet) of the most up to date music software and tools, enhancing your MIDI instrument experience.
Acroread_	Acrobat Reader *2 *3	PDF (Portable Document Format) viewer. Enables you to view each PDF manual for the applications.

### For Macintosh

Folder Name	Application/Data Name	Contents
SongFiler	Song Filer *1 *2	Enables downloading of song data from a computer to the instrument.
OMS_	Open Music System (OMS) *2	Enables you to use several MIDI applications on the Mac OS.
	OMS Setup for YAMAHA *2	Contains the OMS setup files for the Yamaha MIDI instrument.
USBdrv_	USB Driver	Enables your computer to communicate with the MIDI instrument when your computer and the MIDI instrument are connected using a USB cable.
SampleSongs	YMIA Introduction HTML	Enables you to take advantage (via the Internet) of the most up to date music software and tools, enhancing your MIDI instrument experience.
Acroread_	Acrobat Reader *2 *3	PDF (Portable Document Format) viewer. Enables you to view each PDF manual for the applications.

\*1 Song Filer cannot be used with the instrument when the instrument is in one of the following conditions.

- Demo song mode
- Recording
- When no SmartMedia card is inserted

\*2 The applications are supplied with online/PDF manuals.

\*3 Unfortunately, Yamaha makes no guarantee concerning the stability of these programs nor can it offer user support for them.

## CD-ROM Installation Procedure

The following steps are the same for both Windows and Macintosh.

- 1 Verify that your system meets the operating requirements of the software (Song Filer, driver, etc.)  
See the Minimum System Requirements.
- 2 Connect the MIDI instrument to your computer.  
Refer to the owner's manual for details on connections.

### NOTE

- Depending on the computer system you are using, some types of connections may not be possible.

- 3 Install the appropriate driver to your computer, and make the necessary settings.

See page 72 (Windows) or page 74 (Macintosh).

- 4 Install the software (Song Filer, etc.).  
Acrobat Reader/File Utility/YAMAHA USB MIDI Driver:  
See page 72 (Windows) or page 74 (Macintosh).
- 5 Start up the software.

For subsequent operations, refer to the owner's manual for each software program (online help/PDF manual).

### NOTE

- In order to view PDF files, you will need to install Acrobat Reader in your computer.  
See page 72 (Windows) or page 74 (Macintosh).

## Minimum System Requirements

### For Windows

Data Name	OS	CPU	Memory	Hard Disk	Display	Other
Song Filer	Windows 95/98/98SE/Me/2000/XP Home Edition/XP Professional	100 MHz or higher; Intel® Pentium®/Celeron® processor family	8 MB or more		800 x 600, 256 colors or more	—
USB Driver for Windows 98/Me	Windows 98/98SE/Me	166 MHz or higher; Intel® Pentium®/Celeron® processor family	32 MB or more	2 MB or more	—	—
USB Driver for Windows 2000/XP	Windows 2000/XP Home Edition/XP Professional				—	—

### For Macintosh

Data Name	OS	CPU	Memory	Hard Disk	Display	Other
Song Filer	Mac OS 7.5 through OS 9.22 (The Mac OS X and Mac Classic environments are not supported)	A Macintosh computer with a PowerPC or later CPU.	8 MB or more	2 MB or more	800 x 600, 256 colors or more	—
USB Driver	Mac OS 8.6 through OS 9.22 (The Mac OS X and Mac Classic environments are not supported)		64 MB or more (128 MB or more is recommended)		—	OMS 2.3.3 or later (included in the CD-ROM in the package)

## For Windows Users

### Software Installation

**NOTE**

- For details about the application software which has no installation guide described below, refer to the online manual of each software.

#### Uninstall (Removing the installed application)

You can remove the installed application software.

##### Windows 98/Me/2000

Select [START] → [Settings] → [Control Panel] → [Add/Remove Programs] → [Install/Uninstall], then select the application to be removed and click [Add/Remove...]. Follow the on-screen instructions to uninstall the application.

**NOTE**

- The button names or menus may differ depending on the computer OS.

##### Windows XP

Select [START] → [Control Panel] → [Add/Remove Programs], then select the application to be removed and click [Remove]. Follow the on-screen instructions to uninstall the application.

### Acrobat Reader

In order to view the electronic (PDF) manuals included with each application, you'll need to install Acrobat Reader.

**NOTE**

- If an older version of Acrobat Reader is installed on your PC, you'll need to uninstall it before proceeding.

- Double-click on the "Acroread\_" folder. Four different language folders will be displayed.

- Select the language you want to use and double-click on its folder. The file "ar\*\*\*.exe" file will be displayed. ("\*\*\*" indicates the selected language.)
- Double-click on "ar\*\*\*.exe." Acrobat Reader Setup Dialog box will be displayed.
- Execute the installation by following the on-screen directions.

After installation is complete, the Acrobat folder appears on your PC (in Program Files, as the default).

For information on using the Acrobat Reader, refer to the Reader Guide in the Help menu.

### USB MIDI Driver

To operate the MIDI instrument from your computer via USB, you'll need to install the appropriate driver software. The USB-MIDI driver is software that transfers MIDI data back and forth between sequence software and the MIDI instrument via a USB cable.

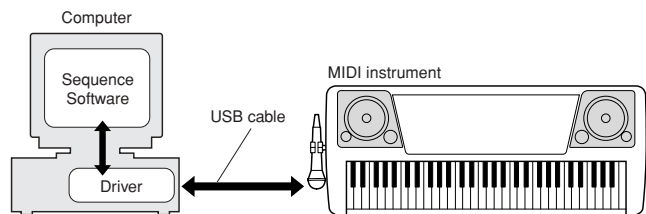

**NOTE**

- Before you install the USB MIDI driver, you can minimize the possibility of problems by putting your computer in the following state.
  - Close all applications and windows that you are not using.
  - Disconnect all cables from the MIDI instrument except for the cable whose driver you are installing.



## Installation for Windows 98/Me/2000/XP

- 1 Start the computer.  
For **Windows 2000/XP** execute the following steps after the computer is started.

In **Windows 2000**, use the “Administrator” account to log in, then select [My Computer] → [Control Panel] → [System] → [Hardware] → [Driver Signing] → [File Signature Verification]. Check the radio button next to “Ignore — Install all files, regardless of file signature,” then click “OK.”

In **Windows XP**, select [Start] → [Control Panel]. (If the control panel appears as shown below, click “Switch to Classic View” at the upper left of the window to display all Control Panel icons.) Next, go to [System] → [Hardware] → [Driver Signing] → [File Signature Verification] and check the radio button next to “Ignore — Install software, not want to check (I),” then click “OK.” Click “OK” to close System Properties, then close the Control Panel by clicking the close box [x] at the top right of the display.

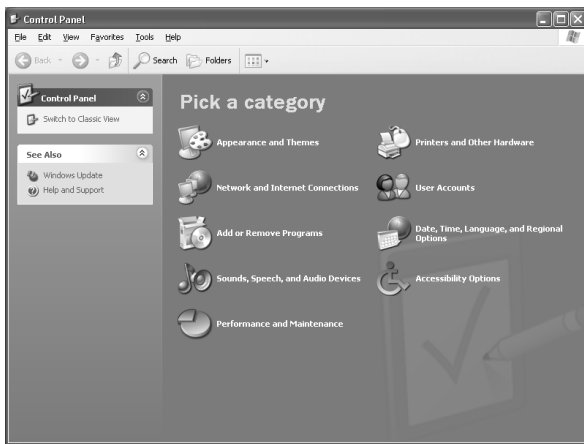

- 2 Insert the included CD-ROM in the CD-ROM drive.
- 3 Check that the instrument is turned off, then connect the USB terminal of the computer to the USB terminal of the instrument with a standard USB cable. Turn on the instrument, and the message “Add New Hardware Wizard” (**Windows 98/Me/2000**) or “Found New Hardware Wizard” (**Windows XP**) automatically appears.

### NOTE

- On some computers, it may take about ten seconds or so for this display to appear after the instrument is turned on.

In **Windows Me**, check the radio button next to “Automatic search for a better driver (Recommended)” of the Add New Hardware Wizard, then click [Next]. The system searches for the proper driver and installation starts automatically. Unless you are manually installing a driver, skip directly to **step 8** below. If a proper driver is not found, select “Specify the location of the driver (Advanced)” and specify the “USBdrv\_” folder on the CD-ROM

In **Windows XP**, check the radio button next to “Install the software automatically (Recommended)” of the Found New Hardware Wizard, then click [Next]. The system searches for the proper driver and installation starts automatically. Unless you are manually installing a driver, skip directly to **step 8** below.

- 4 Click [Next].  
From the window that appears, you can select the method of searching for the driver.

- 5 Check the radio button next to “Search for a suitable driver for my device. (Recommended),” then click [Next].  
From this window, you can specify the location of the driver.

- 6 In **Windows 98**, check the “Specify a location” box, click “Browse..”, then specify the “USBdrv\_” directory of the CD-ROM drive (such as D:\USBdrv\_) and continue the installation.

In **Windows 2000**, check “CD-ROM drive” and make sure all other items are unchecked.

Click [Next]. The system searches for the driver in the CD-ROM and prepares to install.

### NOTE

- In some cases, the system may ask you to insert a Windows CD-ROM while it checks for the driver. If this happens, specify the “USBdrv\_” directory of the CD-ROM drive (for example, D:\USBdrv\_) in Windows 98, or the “USBdrv2k\_” directory (for example, D:\USBdrv2k\_) in Windows 2000, and continue the installation.

- 7 After confirming that “YAMAHA USB MIDI Driver” is shown in the driver search window, click [Next]. Installation starts.

### NOTE

- The exact pathname or location of the driver may differ depending on the particular instrument and other variables.

- 8 When the installation is complete and a message appears to indicate completion, click [Finish].

### NOTE

- On some computers, it may take about ten seconds or so for this message to appear after installation is complete.

In **Windows 2000/XP**, the computer is restarted.

The driver has been properly installed.

## ■ Installing Song Filer

- 1 Double-click on the “SongFiler\_” folder in the CD-ROM.  
The contents of the folder (including the “Setup.exe” file) are displayed.
- 2 Double-click on the file “Setup.exe”.  
The setup dialog appears.
- 3 Execute the installation following the onscreen directions.

For instructions and operation details, refer to the online help and PDF manual.

\* For the latest version of Song Filer, go to the following website.

<http://www.yamahapkclub.com/english/download/songfiler/songfiler.htm>

When using Song Filer, follow the steps below to set the MIDI port to USB.

- 1 Connect the instrument to your computer with a USB cable.
- 2 First, turn on your computer, then the instrument, and finally, start Song Filer.
- 3 Open the “MIDI Port Setting” from the Song Filer menu bar, and select “USB.”

### CAUTION

- If a “LOW BATTERY!!” message appears during transmission of a file using Song Filer, stop the transmission immediately.

## For Macintosh Users

### Software Installation

#### ■ Acrobat Reader

In order to view the electronic (PDF) manuals included with each application, you'll need to install Acrobat Reader.

- 1 Double-click on the "Acroread\_" folder. Four different language folders will be displayed: English, German, French and Spanish.
- 2 Select the language you want to use and double-click on its folder. "Reader Installer" will be displayed. The Installer name may differ depending on the language you select.
- 3 Double-click on the "Reader Installer." Acrobat Reader Setup Dialog will be displayed.
- 4 Execute the installation by following the directions appearing on the screen. After installation is complete, the Acrobat folder appears on your computer (in Hard Disk, as the default). For information on using the Acrobat Reader, refer to the Reader Guide in the Help menu.

#### ■ Open Music System (OMS)

OMS allows you to use several MIDI applications on the Mac OS at the same time.

- 1 Double-click on the "OMS\_" folder (English version only). "Install OMS \*\*\*\*\*" will be displayed.
- 2 Double-click on "Install OMS \*\*\*\*\*." OMS Setup Dialog will be displayed.
- 3 Execute the installation by following the on-screen directions. After the installation, select "Restart."

##### NOTE

- After the installation is complete, you may possibly encounter an error message warning that the installer did not close. In this case, go to the "File" menu and select "Quit" to close the installer. Then reboot the computer.

After restarting the Macintosh, you will find the "Opcode"/"OMS Applications" folder on your computer (Hard Disk, as the default).

- 4 Copy the "OMS\_\*\*\*\_Mac.pdf" in the CD-ROM to the "OMS Applications" folder (drag-and-drop it to the folder). Refer to the "OMS\_\*\*\*\_Mac.pdf" (English version only) how to use the application.
- 5 Copy the "OMS Setup for YAMAHA" in the CD-ROM to the "OMS Applications" folder (drag-and-drop it to the folder). In the "OMS Setup for YAMAHA" folder you will find the OMS Setup files for the Yamaha tone generators, which can be used as templates.

#### ■ USB MIDI Driver

To operate the MIDI instrument from your computer via USB, you'll need to install the appropriate driver software. The USB-MIDI driver is software that transfers MIDI data back and forth between sequence software and the MIDI instrument via a USB cable.

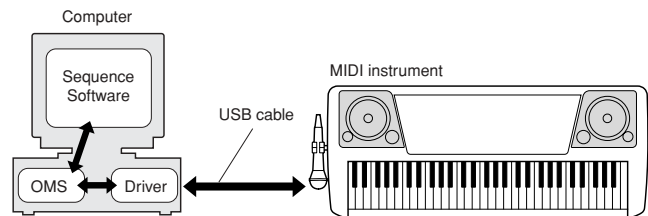

First install OMS before you install the USB-MIDI driver. Also, after installing the driver, you will need to set up OMS (see page 75).

- 1 Start the computer.
- 2 Insert the included CD-ROM into the CD-ROM drive. The system displays the CD-ROM icon on the desktop.
- 3 Double-click the CD-ROM icon and double-click the "Install USB Driver" icon in the "USBdrv\_" folder to display the following installation screen.



- 4 The "Install Location" box displays the destination of the installation. If you wish to change the destination disk or folder, use the [Switch Disk] button and the pop-up menu to specify the desired destination.

##### NOTE

- This box usually displays the start-up disk as the destination.

- 5 Click the [Install] button. The system displays the following message: "This installation requires your computer to restart after installing this software. Click Continue to automatically quit all other running applications." Click [Continue].

##### NOTE

- To cancel the installation, click [Cancel].

- 6 The installation starts. If the driver has already been installed, the following message appears. To return to step 3, press [Continue]. To complete the installation, click [Quit].



- 7 When the installation is complete, the system displays the following message: "Installation was successful. You have installed software which requires you to restart your computer." Click [Restart]. The computer automatically restarts. You can locate the installed files in the following locations:

- [System Folder] → [Control Panels] → [YAMAHA USB MIDI Patch]
- [System Folder] → [Extensions] → [USB YAMAHA MIDI Driver]
- [System Folder] → [OMS Folder] → [YAMAHA USB MIDI OMS Driver]

### ■ Installing Song Filer

- 1 Double-click on the "SongFiler\_" folder in the CD-ROM. "Install Song Filer" file will be displayed.
- 2 Double-click on the "Install Song Filer" file. The Song Filer installation dialog will be displayed. Execute the installation by following the on-screen directions.

**NOTE**

- Select "Custom Installation" if you want to access PDF manuals in languages other than English.

- 3 After installing, restart the computer.

For instructions and operation details, refer to the online help and PDF manual.

\* For the latest version of Song Filer, go to the following website.

<http://www.yamahapkclub.com/english/download/songfiler/songfiler.htm>

## Setting up OMS

The OMS studio setup file for the MIDI instrument is contained in the included CD-ROM. This studio setup file is used for setting up OMS.

**NOTE**

- Before performing the following procedure, the OMS and USB MIDI Driver should be installed (see page 74).

- 1 Use a USB cable to connect the USB terminal of the computer (or the USB hub) to the USB terminal of the MIDI instrument and turn the MIDI instrument's power on.
- 2 Start the computer.
- 3 Insert the included CD-ROM into the CD-ROM drive of your Macintosh computer. The CD-ROM icon appears on the desktop.
- 4 Double-click on the CD-ROM icon, "OMS\_", and "OMS Setup for YAMAHA." The file "\*\*\*\*\*-USB" appears. ("\*\*\*\*\*" indicates the product name, etc.) Copy this to the hard disk on your computer.
- 5 Double-click on the "\*\*\*\*\*-USB" file to start the OMS Setup.
- 6 After starting the OMS Setup, the Studio setup file double-clicked in step 5 opens.

Indicates this setup is available

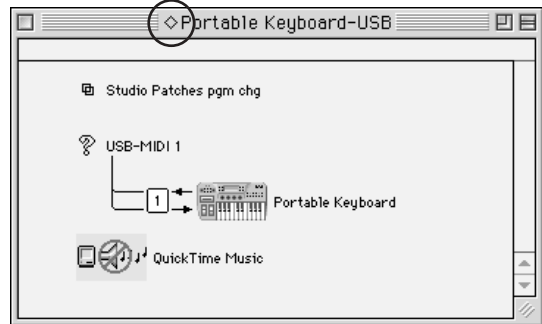

**NOTE**

- If "◊" is not indicated at the left of the setup file name, select "Make Current" from the "File" menu and execute the save operation.

The OMS studio setup has been completed.

**NOTE**

- After the OMS studio setup above has been completed, your computer will recognize only the MIDI instrument as a MIDI instrument. If you use another MIDI instrument in addition to the MIDI instrument or you add a second MIDI instrument to the existing system, you should create an original Studio Setup file. For details, refer to the on-line manual supplied with the OMS.

Depending on the Macintosh and operating system version that you are using, the included studio setup file for the MIDI instrument still may not work even after you have performed the above steps. (MIDI transmission and reception will not be possible even if the setup is valid.)

In this case, use the following procedure to re-create the setup file.

- 1 Connect the MIDI instrument and Macintosh via USB cable, and turn on the power of the MIDI instrument.
- 2 Start up OMS Setup, and from the “File” menu, choose “New setup.”
- 3 The OMS driver search dialog box will appear. Uncheck both [Modem] and [Printer] if you are using a USB connection.
- 4 Click the [Find] button to search for the device. When a device has been found, the OMS Driver Setting dialog box will display “USB-MIDI.”
  - If the device was found correctly, click the [OK] button to proceed.
  - If the device was not found, re-check that the cable connections are correct, and repeat the procedure from step 1.
- 5 Make sure that the port is shown below the device that was found. (This will be a name such as USB-MIDI.) Check the check box for the port, and then click the [OK] button.
- 6 A dialog box will appear, allowing you to name the file that will be saved. Input the desired filename, and click [Save].  
This completes the OMS setup.
- 7 From the “Studio” menu, choose “Test,” and click the port icon.  
If a channel sounds on the MIDI instrument, the system is operating correctly.

For details on using OMS, refer to “OMS\_\*\*\*\_Mac.pdf,” included with OMS.

## SOFTWARE LICENSING AGREEMENT

The following is a legal agreement between you, the end user, and Yamaha Corporation (“Yamaha”). The enclosed Yamaha software program is licensed by Yamaha to the original purchaser for use only on the terms set forth herein. Please read this licensing agreement with care. Opening this package indicates that you accept all terms outlined herein. If you do not agree to the terms, return this package unopened to Yamaha for a full refund.

### 1. GRANT OF LICENSE AND COPYRIGHT

Yamaha grants you, the original purchaser, the right to use one copy of the enclosed software program and data (“SOFTWARE”) on a single-user computer system. You may not use it on more than one computer or computer terminal. The SOFTWARE is owned by Yamaha and is protected by Japanese copyright laws and all applicable international treaty provisions. You are entitled to claim ownership of the media in which the SOFTWARE is included. Therefore, you must treat the SOFTWARE like any other copyrighted materials.

### 2. RESTRICTIONS

The SOFTWARE program is copyrighted. You may not engage in reverse engineering or reproduction of the SOFTWARE by other conceivable methods. You may not reproduce, modify, change, rent, lease, resell, or distribute the SOFTWARE in whole or in part, or create derivative works from the SOFTWARE. You may not transmit or network the SOFTWARE with other computers. You may transfer ownership of the SOFTWARE and the accompanying written materials on a permanent basis provided that you retain no copies and the recipient agrees to the terms of the licensing agreement.

### 3. TERMINATION

The licensing condition of the software program becomes effective on the day that you receive the SOFTWARE. If any one of the copyright laws or clauses of the licensing conditions is violated, the licensing agreement shall be terminated automatically without notice from Yamaha. In this case, you must destroy the licensed SOFTWARE and its copies immediately.

### 4. PRODUCT WARRANTY

Yamaha warrants to the original purchaser that if the SOFTWARE, when used in normal conditions, will not perform the functions described in the manual provided by Yamaha, the sole remedy will be that Yamaha will replace any media which proves defective in materials or workmanship on an exchange basis without charge. Except as expressly set forth above, the SOFTWARE is provided “as is,” and no other warranties, either expressed or implied, are made with respect to this software, including, without limitation the implied warranties of merchantability and fitness for a particular purpose.

### 5. LIMITED LIABILITY

Your sole remedies and Yamaha’s entire liability are as set forth above. In no event will Yamaha be liable to you or any other person for any damages, including without limitation any incidental or consequential damages, expenses, lost profits, lost savings or other damages arising out of the use or inability to use such SOFTWARE even if Yamaha or an authorized dealer has been advised of the possibility of such damages, or for any claim by any other party.

### 6. GENERAL

This license agreement shall be interpreted according to and governed by Japanese laws.



# Function settings

The Function pages (found in the FUNCTION display) contain detailed controls and settings for the voices, effects, split point, tuning of the instrument, and so on. Commonly used settings can be called up by a button shortcut: Simply hold down a button (for about a second) to directly call up the relevant setting page.

## Calling up the setting pages

- 1 Press the [FUNCTION] button to enter the FUNCTION display.

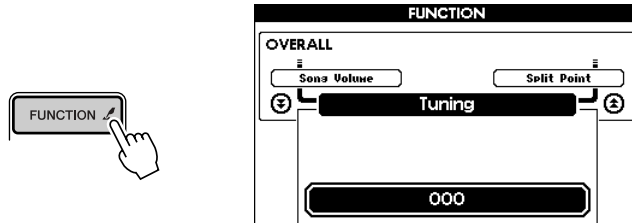

- 2 Call up the desired page by using the CATEGORY buttons [▲]/[▼]. For details on the settings, refer to the FUNCTION settings List on the page 78. The previous page's title appears at the upper left of the display, and the next page's title appears at the upper right of the display.

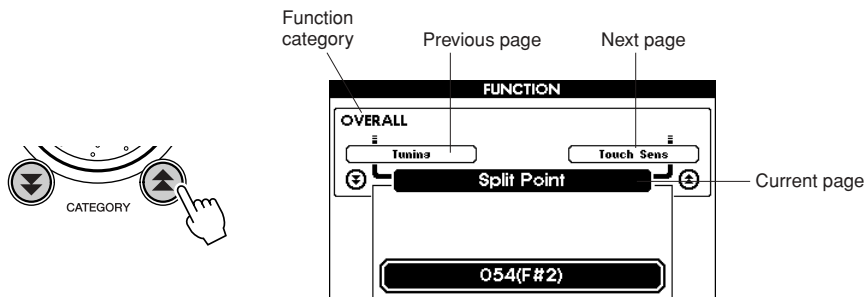

- 3 Set the value by using the dial, [+]/[-] buttons, or numeric keypad [0] – [9]. For ON/OFF settings, use the [+] button (ON) and [-] button (OFF). For operations, use the [+] button to execute the operation, or the [-] button to cancel.

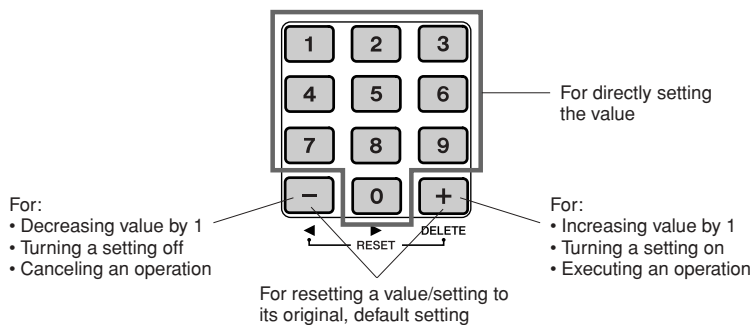

- 4 Save your settings to SmartMedia card, if desired, by holding down the [FUNCTION] button. All settings made in the FUNCTION display are memorized to the instrument when you set them. However, all your custom settings are deleted when the power is turned off. If you want to save any settings, you'll need to back them up to SmartMedia card (with this step) so that the next time you turn on the power, the settings are loaded from the SmartMedia card to the instrument (page 84).



■ FUNCTION Settings List

Category	Setting	Page title	Range / Settings	Description
VOLUME	Style Volume	Style Volume	000 – 127	This determines the volume of the Style.
	Song Volume	Song Volume	000 – 127	This determines the volume of the Song.
OVERALL	Tuning	Tuning	-100 – 100	This determines the pitch of the entire instrument's sound.
	Split Point	Split Point	000 – 127 (C-2 – G8)	This determines the highest key for the Split voice and sets the Split "point" — in other words, the key that separates the Split (lower) and Main (upper) voices. The Split Point setting and Accompaniment Split Point setting are automatically set to the same value.
	Touch Sensitivity	Touch Sense	1 (Soft) / 2 (Medium) / 3 (Hard)	When Touch Response is on, this determines the sensitivity of the feature.
M. VOICE	Volume	M. Volume	000 – 127	This determines the volume of the Main voice.
	Octave	M. Octave	-2 – +2	This determines the octave range for the Main voice.
	Pan	M. Pan	000 (left) – 64 (center) – 127 (right)	This determines the pan position of the Main voice in the stereo image. The value "0" results in the sound being panned full left; the value "127" results in the sound being panned full right.
	Reverb Send Level	M. Reverb Level	000 – 127	This determines how much of the Main voice's signal is sent to the Reverb effect.
	Chorus Send Level	M. Chorus Level	000 – 127	This determines how much of the Main voice's signal is sent to the Chorus effect.
D. VOICE	Volume	D. Volume	000 – 127	This determines the volume of the Dual voice.
	Octave	D. Octave	-2 – +2	This determines the octave range for the Dual voice.
	Pan	D. Pan	000 (left) – 64 (center) – 127 (right)	This determines the pan position of the Dual voice in the stereo image. The value "0" results in the sound being panned full left; the value "127" results in the sound being panned full right.
	Reverb Send Level	D. Reverb Level	000 – 127	This determines how much of the Dual voice's signal is sent to the Reverb effect.
	Chorus Send Level	D. Chorus Level	000 – 127	This determines how much of the Dual voice's signal is sent to the Chorus effect.
S. VOICE	Volume	S. Volume	000 – 127	This determines the volume of the Split voice.
	Octave	S. Octave	-2 – +2	This determines the octave range for the Split voice.
	Pan	S. Pan	000 (left) – 64 (center) – 127 (right)	This determines the pan position of the Split voice in the stereo image. The value "0" results in the sound being panned full left; the value "127" results in the sound being panned full right.
	Reverb Send Level	S. Reverb Level	000 – 127	This determines how much of the Split voice's signal is sent to the Reverb effect.
	Chorus Send Level	S. Chorus Level	000 – 127	This determines how much of the Split voice's signal is sent to the Chorus effect.
EFFECT	Reverb Type	Reverb	01 – 10	This determines the Reverb type, including off (10). (See the list on page 46)
	Chorus Type	Chorus	01 – 05	This determines the Chorus type, including off (05). (See the list on page 46)
HARMONY	Harmony Type	Harmony Type	01 – 26	This determines the Harmony type. (See the list on page 46)
	Harmony Volume	Harmony Volume	000 – 127	This determines the level of the Harmony effect when Harmony type 1-5 is selected.
PC	PC mode	PC Mode	ON/OFF	When this is set to ON, the instrument settings are configured for use with a computer/sequencer. (page 69)

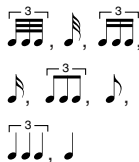
Category	Setting	Page title	Range / Settings	Description
MIDI	Local On/Off	Local	ON/OFF	This determines whether the instrument's keyboard controls the internal tone generator (ON) or not (OFF). (page 67)
	External Clock	External Clock	ON/OFF	This determines whether the instrument synchronizes to the internal clock (OFF) or an external clock (ON). (page 68)
	Initial Setup Send	Initial Send	YES/NO	This lets you send the data of the panel settings to a computer (for example, for recording to a song). Press [+] to send, or press [-] to cancel. Use the [+] button to transmit the data. Use the [-] button to stop the transmission. (page 68)
	Keyboard Out	KeyboardOut	ON/OFF	This determines whether Keyboard performance data of the instrument is transmitted (ON) or not (OFF). (page 68)
	Style Out	StyleOut	ON/OFF	This determines whether Style data is transmitted (ON) via USB or not (OFF). Press the +/[-] buttons to set the Style Out to on or off. (page 68)
	Song Out	SongOut	ON/OFF	This determines whether Song data is transmitted (ON) via USB or not (OFF). (page 68)
METRONOME	Time Signature	Time Signature	00 – 15	This determines the time signature of the Metronome.
	Metronome Volume	Metronome Volume	000 – 127	This determines the volume of the Metronome.
SCORE	Quantize	Quantize		Depending on the song data, you can make the notation (score) more readable by adjusting the timing of the notes. This determines the minimum timing resolution used in the song. For example, if there are both quarter notes and eighth notes in the song, you should set this a values of “♪” (eighth note). Any notes or rests shorter than this value will not be shown in the notation.
LESSON	Lesson Track (R)	R-Part	GuideTrack 1 – 16	This determines the guide track number for your right hand lesson. The setting is only effective for SmartMedia card songs (SMF).
	Lesson Track (L)	L-Part	GuideTrack 1 – 16	This determines the guide track number for your left hand lesson. The setting is only effective for SmartMedia card songs (SMF).
UTILITY	Grade	Grade	ON/OFF	This determines whether Grade function is on or off.
	Demo Cancel	D-Cancel	ON/OFF	This determines the Demo cancel is enabled or not. When this is set to ON, the Demo Song does not play, even if the [DEMO] button is pressed.
MIC	Microphone Volume	Mic Volume	000 – 127	This determines the volume of the microphone.
	Microphone Echo Volume	Mic Echo	000 – 127	This determines the amount of Microphone Echo.
LANGUAGE	Language Select	Language	English/ Japanese	This determines the display language for the demo displays, song file names, lyrics and certain display messages. All other messages and names are displayed in English. When this is set to Japanese, the file names are displayed in the Japanese font. The lyrics display follows the language setting originally made in the song data; however, when no such setting exists, the setting here is used.

\* All these settings can be conveniently reset to their initial default values by pressing the [+] and [-] buttons simultaneously. (The exception to this is Initial Setup Send, which is an operation, not a setting.)

# Troubleshooting

## ■ For the PSR-K1

Problem	Possible Cause and Solution
When the instrument is turned on or off, a popping sound is temporarily produced.	This is normal and indicates that the instrument is receiving electrical power.
When using a mobile phone, noise is produced.	Using a mobile phone in close proximity to the instrument may produce interference. To prevent this, turn off the mobile phone or use it further away from the instrument.
There is no sound even when the keyboard is played or when a song or style is being played back.	Check that nothing is connected to the PHONES/OUTPUT jack on the rear panel. When a set of headphones is plugged into this jack, no sound is output.
	Check the Local Control on/off. (See page 67.)
Playing keys in the right hand area of the keyboard does not produce any sound.	When using the Dictionary function (page 50), the keys in the right hand area are used only for entering the chord root and type.
<ul style="list-style-type: none"> <li>• The volume is too soft.</li> <li>• The sound quality is poor.</li> <li>• The rhythm stops unexpectedly or will not play.</li> <li>• The recorded data of the song, etc. does not play correctly.</li> <li>• The LCD display suddenly goes dark, and all panel settings are reset.</li> </ul>	<p>The batteries are low or dead. Replace all six batteries with completely new ones, or use the included AC adaptor.</p>
The auto accompaniment doesn't turn on, even when pressing the [ACMP ON/OFF] button.	Make sure the Style mode is active before using the auto accompaniment. Press the [STYLE] button to enable style operations.
The style or song does not play back even when pressing the [START/STOP] button.	Is External Clock set to ON? Make sure External Clock is set to OFF; refer to "External Clock" on page 68.
The style does not sound properly.	Make sure that the Style Volume (page 47) is set to an appropriate level.
	Is the Split Point setting inappropriate for chord play? Set the Split Point to the proper position; refer to "Setting the Split Point" on page 42.
When playing back one of the Pianist styles (#124 – #135), the rhythm cannot be heard.	This is normal. The Pianist styles have no drums or bass — only piano accompaniment.
Not all of the voices seem to sound, or the sound seems to be cut off.	The instrument is polyphonic up to a maximum of 32 notes. If the Dual voice or Split voice is being used and a style or song is playing back at the same time, some notes/sounds may be omitted (or "stolen") from the accompaniment or song.
The footswitch (for sustain) seems to produce the opposite effect. For example, pressing the footswitch cuts off the sound and releasing it sustains the sounds.	The polarity of the footswitch is reversed. Make sure that the footswitch plug is properly connected to the SUSTAIN jack before turning on the power.
The sound of the voice changes from note to note.	This is normal. The AWM tone generation method uses multiple recordings (samples) of an instrument across the range of the keyboard; thus, the actual sound of the voice may be slightly different from note to note.
The Demo display is shown in Japanese, and/or there are Japanese characters in the display messages.	Make sure the Language setting in the FUNCTION display is set to English. (See page 79.)



## ■ For the included software

### The driver cannot be installed.

- Is the USB cable connected correctly?
  - Check the USB cable connection.
  - Disconnect the USB cable, then connect it again.

### Windows

- Is the USB function enabled on your computer?
  - When you connect the MIDI instrument to the computer for the first time, if the “Add New Hardware Wizard” does not appear, the USB function on the computer may be disabled (see page 73). Perform the following steps.
    - 1** Select [Control Panel] → [System] → [Device Manager] (for Windows 98/Me), or select [Control Panel] (Windows XP: Classic View) → [System] → [Hardware] → [Device Manager] (for Windows 2000/XP).
    - 2** In the Device Manager, make sure that the marks “!” and “x” are NOT shown for the “Universal Serial Bus controllers” or “USB Root Hub” (nested within “Universal Serial Bus controllers”). (Make sure that “Device by type” is selected in the View menu for Windows XP/2000. In Windows 98/Me, click the “View devices by type” radio button at the top.) If you see an “!” or “x” mark, the USB controller is disabled. For more information, refer to the owner’s manual of your computer.

### Windows

- Is any unknown device registered?
  - If driver installation fails, the MIDI instrument will be marked as an “Unknown device,” and you will not be able to install the driver. Delete the “Unknown device” by following the steps below.
    - 1** Select [Control Panel] → [System] → [Device Manager] (for Windows 98/Me), or select [Control Panel] (Windows XP: Classic View) → [System] → [Hardware] → [Device Manager] (for Windows 2000/XP).
    - 2** Check for an “Other device” in the Device Manager. (Make sure that “Device by type” is selected in the View menu for Windows XP/2000. In Windows 98/Me, click the “View devices by type” radio button at the top.)
    - 3** If you find “Other devices,” double-click it to extend the tree to look for “Unknown device.” If one appears, select it and click the [Remove] button.
    - 4** Remove the USB cable from the MIDI instrument, and make the connection again.
    - 5** Install the driver again. See page 73.

### When controlling the MIDI instrument from your computer via USB, the MIDI instrument does not operate correctly or no sound is heard.

- Did you install the driver?
  - Windows users See page 72.
  - Macintosh users See page 74.
- Is the USB cable connected correctly?
- Are the volume settings of the tone generator, playback device, and application program set to the appropriate levels?
- Have you selected an appropriate port in the sequence software?
- Are you using the latest USB MIDI driver?
  - The latest driver can be downloaded from the following web site.  
<http://www.yamahasyth.com/>

### Playback response is delayed.

- Does your computer satisfy the system requirements?
- Is any other application or device driver running?

### Macintosh

- Turn off virtual memory.
- Disable AppleTalk.

### Cannot suspend or resume the computer correctly.

- Do not suspend the computer while the MIDI application is running.
- If you are using Windows 2000, you may not be able to suspend/resume normally, depending on the particular environment (USB Host Controller, etc.). Even so, simply disconnecting and connecting the USB cable will allow you to use the MIDI instrument functions again.

### How can I delete or re-install the driver?

#### Windows Me/98

- 1** When the MIDI instrument is recognized correctly, double-click “System” in the Control Panel to open the System window.
- 2** Double-click the “Device Manager” tab, select “YAMAHA USB MIDI Driver” and delete it.
- 3** Use the MS-DOS prompt or Explorer to delete the following three files.
  - \WINDOWS\INF\OTHER\YAMAHAMIDI instrument.INF
  - \WINDOWS\SYSTEM\Xgusb.driv
  - \WINDOWS\SYSTEM\Ymidusb.sys

#### NOTE

- To delete the above files using Explorer, select “Folder Options” from the Tool (View) menu, and select “Show all files (and folders).”

- 4** Disconnect the USB cable.
- 5** Restart the computer.
- 6** Re-install the driver (see page 72).

#### Macintosh

- 1** Delete the files in the following locations:
  - [System Folder] → [Control Panels] → [YAMAHA USB MIDI Patch]
  - [System Folder] → [Extensions] → [USB YAMAHA MIDI Driver]
  - [System Folder] → [OMS Folder] → [YAMAHA USB MIDI OMS Driver]
- 2** Restart the computer.
- 3** Install the driver (see page 74) and set up OMS (see page 75).

# Messages

Display
Access error !
Are you sure ?
Backup Loading
Backup Loading Error
Cancel
Can't use
Clearing...
Com Mode
Completed
Data Error !
Delete File
Delete OK ?
Deleting...
Do you clear Track1 ?
Do you clear Track2 ?
Do you clear Track3 ?
Do you clear Track4 ?
Do you clear Track5 ?
Do you clear TrackA ?
Do you clear User Song1 ?
Do you clear User Song2 ?
Do you clear User Song3 ?
Do you clear User Song4 ?
Do you clear User Song5 ?
End
Error
File information area is not large enough.
File is not found.
File too large. Loading is impossible.
Format OK ?
Formatting...
Initial Setup
Load OK ?
Loading...

Display
Media is not inserted.
Media Mounting
Memory capacity is full.
Memory Full
MIDI receive buffer overflow.
Now executing...
Now executing... (Don't turn off the power now, otherwise the data may be damaged.)
Now Writing... (Don't turn off the power now, otherwise the data may be damaged.)
Overwrite?
Please Wait...
Rename File
Save OK ?
Saved data is not found.
Saves the selected melody and style. (Don't turn off the power now, otherwise the data may be damaged.)
Saving...
Send OK?
Sending...
Since the media is in use now, this function is not available.
Sure?
The limit of the media has been reached.
The media is not formatted.
The media is write-protected.
The song data is too large to be converted to notation.
There are too many files.
This function is not available now.

# Saving backup data to SmartMedia card

The panel settings of this instrument are reset to their original default settings every time you turn power off and on again, which means your original settings are lost. However, with a SmartMedia card, you can save your custom panel settings for recall by holding down the [FUNCTION] button. The next time you turn the power on (with the proper SmartMedia card inserted), all your custom settings are reloaded to the instrument. Please keep in mind that turning the power on automatically will reset the panel settings to the original default settings if no SmartMedia card or a SmartMedia card with no data is inserted to the CARD slot.

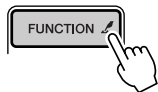

Press and hold

## **NOTE**

- Data cannot be saved to a SmartMedia card during song playback.

## **CAUTION**

- The setting data backed up to the SmartMedia card is automatically given the same file name "PSR-K1.ENV"; saving new data always overwrites and deletes the previous data. This also deletes the Registration Memory data in the SmartMedia card.

## **CAUTION**

- Do not turn off the power when a "WRITING!" message is shown. Doing so may result in loss of data on the SmartMedia card.

## ■ Data which can be backed up

- Registration Memory
- FUNCTION display settings :
  - Tuning, Split Point, Touch Sensitivity, Accompaniment Volume, Song Volume, Metronome Volume, Grade Setting, Demo Cancel, Microphone Volume, Microphone Echo Volume, Language Switch
- Touch Response ON/OFF

# Specifications

## Keyboards

- 61 standard-size keys (C1 - C6), with Touch Response.

## Display

- 320 x 240 dots backlight graphic LCD

## Setup

- STANDBY/ON
- MASTER VOLUME: MIN - MAX
- MIC VOLUME: MIN - MAX
- LCD CONTRAST Control

## Panel Controls

- SONG, VOICE, STYLE, EASY SONG ARRANGER, FILE CONTROL, EXECUTE, DICTIONARY, PERFORMANCE ASSISTANT, PC, LESSON L, LESSON R, METRONOME, PORTABLE GRAND, KARAOKE, SCORE, EXIT, DEMO, FUNCTION, TOUCH, HARMONY, DUAL, SPLIT, TEMPO/TAP, [0] - [9], [+], [-], CATEGORY, Dial, ACMP ON/OFF, SYNC STOP, SYNC START, START/STOP, INTRO/ENDING/rit., MAIN/AUTO FILL, MIC, TRANSPOSE, REGISTRATION MEMORY (MEMORY, BANK, [1], [2]), SONG MEMORY (REC, [1] - [5], [A])

## Voice

- 114 panel voices + 12 drum kits + 360 XG voices
- Polyphony: 32
- DUAL
- SPLIT

## Style

- 135 Preset Styles + 1 SmartMedia Card Style
- Style Control: ACMP ON/OFF, SYNC STOP, SYNC START, START/STOP, INTRO/ENDING/rit., MAIN/AUTO FILL
- Fingering: Multi fingering
- Style Volume

## Card Slot

- 3.3V SmartMedia™

## Education Feature

- Dictionary
- Lesson 1-4

## Registration Memory

- 8 banks x 2 types

## Function

- VOLUME: Style Volume, Song Volume
- OVERALL: Tuning, Split Point, Touch Sensitivity
- MAIN VOICE: Volume, Octave, Pan, Reverb Send Level, Chorus Send Level
- DUAL VOICE: Volume, Octave, Pan, Reverb Send Level, Chorus Send Level
- SPLIT VOICE: Volume, Octave, Pan, Reverb Send Level, Chorus Send Level
- EFFECT: Reverb Type, Chorus Type
- HARMONY: Harmony Type, Harmony Volume
- PC: PC mode
- MIDI: Local On/Off, External Clock, Initial Setup Send, Keyboard Out, Style Out, Song Out
- METRONOME: Time Signature, Metronome Volume
- SCORE: Quantize
- LESSON: Lesson Track (R), Lesson Track (L)
- UTILITY: Grade, Demo Cancel
- MIC: Microphone Volume, Microphone Echo
- LANGUAGE: Language Select (English/Japanese)

## Effects

- Reverb: 9 types
- Chorus: 4 types
- Harmony: 26 types

## Song

- 100 Preset Songs + 5 User Songs + SmartMedia Card Songs
- Song Clear, Track Clear
- Song Volume

## Recording

- Song  
User Song: 5 Songs  
Recording Tracks: 1, 2, 3, 4, 5, STYLE

## MIDI

- Local On/Off
- Initial Setup Send
- External Clock
- Keyboard Out
- Style Out
- Song Out

## Auxiliary jacks

- PHONES, OUTPUT R,L, DC IN 12V, USB, MIC, SUSTAIN

## Amplifier

- With AC power adaptor (PA-5D): 6W + 6W
- With batteries: 4W + 4W

## Speakers

- 12cm x 2 + 3cm x 2

## Power Consumption (when using PA-5D power adaptor)

- 22W

## Power Supply

- Adaptor: Yamaha PA-5C/PA-5D AC power adaptor
- Batteries: Six "D" size, R20P (LR20) or equivalent batteries

## Dimensions (W x D x H)

- 952 x 389 x 158 mm (37-1/2" x 15-1/3" x 6-1/4")
- 994 x 389 x 158 mm (with mic holder)  
(39-1/8" x 15-1/3" x 6-1/4")

## Weight

- 7.0 kg (15 lbs. 7 oz.)

## Supplied Accessories

- Music Rest
- SmartMedia™
- Accessory CD-ROM
- Microphone
- Microphone holder cap (spare)
- Owner's Manual

## Optional Accessories

- Headphones: HPE-150
- AC power adaptor: PA-5C/PA-5D
- Footswitch: FC4/FC5
- Keyboard stand: L-2C

\* Specifications and descriptions in this owner's manual are for information purposes only. Yamaha Corp. reserves the right to change or modify products or specifications at any time without prior notice. Since specifications, equipment or options may not be the same in every locale, please check with your Yamaha dealer.

# Voice List

## Maximum Polyphony

The instrument has 32-note maximum polyphony. This means that it can play a maximum of up to 32 notes at once, regardless of what functions are used. Auto accompaniment uses a number of the available notes, so when auto accompaniment is used the total number of available notes for playing on the keyboard is correspondingly reduced. The same applies to the Split Voice and Song functions. If the maximum polyphony is exceeded, earlier played notes will be cut off and the most recent notes have priority (last note priority).

### NOTE

- The Voice List includes MIDI program change numbers for each voice. Use these program change numbers when playing the instrument via MIDI from an external device.
- Some voices may sound continuously or have a long decay after the notes have been released while the sustain pedal (footswitch) is held.

## Panel Voice List

Voice No.	Bank Select		MIDI Program Change# (1 - 128)	Voice Name
	MSB (0 - 127)	LSB (0 - 127)		
<b>PIANO</b>				
001	0	112	1	Grand Piano
002	0	112	2	Bright Piano
003	0	112	4	Honky-tonk Piano
004	0	112	3	MIDI Grand Piano
005	0	113	3	CP 80
006	0	112	7	Harp
<b>E.PIANO</b>				
007	0	114	5	Galaxy E.Piano
008	0	112	5	Funky E.Piano
009	0	112	6	DX Modern E.Piano
010	0	113	6	Hyper Tines
011	0	114	6	Venus E.Piano
012	0	112	8	Clavi
<b>ORGAN</b>				
013	0	118	19	Cool! Jazz Organ
014	0	112	17	Jazz Organ 1
015	0	113	17	Jazz Organ 2
016	0	112	18	Click Organ
017	0	116	17	Bright Organ
018	0	112	19	Rock Organ
019	0	114	19	Purple Organ
020	0	118	17	16'+2' Organ
021	0	119	17	16'+4' Organ
022	0	114	17	Theater Organ
023	0	112	20	Church Organ
024	0	113	20	Chapel Organ
025	0	112	21	Reed Organ
<b>ACCORDION</b>				
026	0	113	22	Trad Accordion
027	0	112	22	Musette
028	0	113	24	Bandoneon
029	0	112	23	Harmonica
<b>GUITAR</b>				
030	0	112	25	Classical Guitar
031	0	112	26	Folk Guitar
032	0	113	26	12Strings Guitar
033	0	112	27	Jazz Guitar
034	0	113	27	Octave Guitar
035	0	112	28	Clean Guitar
036	0	117	28	60's Clean Guitar
037	0	112	29	Muted Guitar
038	0	112	30	Overdriven
039	0	112	31	Distortion
<b>BASS</b>				
040	0	112	33	Acoustic Bass
041	0	112	34	Finger Bass
042	0	112	35	Pick Bass
043	0	112	36	Fretless Bass
044	0	112	37	Slap Bass
045	0	112	39	Synth Bass
046	0	113	39	Hi-Q Bass
047	0	113	40	Dance Bass
<b>STRINGS</b>				
048	0	112	49	String Ensemble
049	0	112	50	Chamber Strings
050	0	112	51	Synth Strings

Voice No.	Bank Select		MIDI Program Change# (1 - 128)	Voice Name
	MSB (0 - 127)	LSB (0 - 127)		
051	0	113	50	Slow Strings
052	0	112	45	Tremolo Strings
053	0	112	46	Pizzicato Strings
054	0	112	56	Orchestra Hit
055	0	112	41	Violin
056	0	112	43	Cello
057	0	112	44	Contrabass
058	0	112	106	Banjo
059	0	112	47	Harp
<b>CHOIR</b>				
060	0	112	53	Choir
061	0	113	53	Vocal Ensemble
062	0	112	54	Vox Humana
063	0	112	55	Air Choir
<b>SAXOPHONE</b>				
064	0	113	65	Sweet! Soprano Sax
065	0	117	67	Sweet! Tenor Sax
066	0	112	65	Soprano Sax
067	0	112	66	Alto Sax
068	0	112	67	Tenor Sax
069	0	114	67	Breathy Tenor Sax
070	0	112	68	Baritone Sax
071	0	112	69	Oboe
072	0	112	70	English Horn
073	0	112	71	Bassoon
074	0	112	72	Clarinet
<b>TRUMPET</b>				
075	0	115	57	Sweet! Trumpet
076	0	112	57	Trumpet
077	0	112	60	Muted Trumpet
078	0	112	58	Trombone
079	0	113	58	Trombone Section
080	0	112	61	French Horn
081	0	112	59	Tuba
<b>BRASS</b>				
082	0	112	62	Brass Section
083	0	113	62	Big Band Brass
084	0	119	62	Mellow Horns
085	0	112	63	Synth Brass
086	0	113	63	Jump Brass
087	0	114	63	Techno Brass
<b>FLUTE</b>				
088	0	114	74	Sweet! Flute
089	0	112	74	Flute
090	0	112	73	Piccolo
091	0	113	76	Sweet! Pan Flute
092	0	112	76	Pan Flute
093	0	112	75	Recorder
094	0	112	80	Ocarina
<b>SYNTH LEAD</b>				
095	0	112	81	Square Lead
096	0	112	82	Sawtooth Lead
097	0	112	86	Voice Lead
098	0	112	99	Star Dust
099	0	112	101	Brightness
100	0	115	82	Analogon
101	0	119	82	Fargo

Voice No.	Bank Select		MIDI Program Change# (1 - 128)	Voice Name
	MSB (0 - 127)	LSB (0 - 127)		
<b>SYNTH PAD</b>				
102	0	112	89	Fantasia
103	0	113	101	Bell Pad
104	0	112	92	Xenon Pad
105	0	112	95	Equinox
106	0	113	90	Dark Moon
<b>PERCUSSION</b>				
107	0	112	12	Vibraphone
108	0	112	13	Marimba
109	0	112	14	Xylophone
110	0	112	115	Steel Drums
111	0	112	9	Celesta
112	0	112	15	Tubular Bells
113	0	112	48	Timpani
114	0	112	11	Music Box
<b>DRUM KITS (See page 90)</b>				
115	127	0	1	Standard Kit 1
116	127	0	2	Standard Kit 2
117	127	0	9	Room Kit
118	127	0	17	Rock Kit
119	127	0	25	Electronic Kit
120	127	0	26	Analog Kit
121	127	0	28	Dance Kit
122	127	0	33	Jazz Kit
123	127	0	41	Brush Kit
124	127	0	49	Symphony Kit
125	126	0	1	SFX Kit 1
126	126	0	2	SFX Kit 2

### ● XG Voice List

Voice No.	Bank Select		MIDI Program Change# (1 - 128)	Voice Name
	MSB (0 - 127)	LSB (0 - 127)		
<b>PIANO</b>				
127	0	0	1	Grand Piano
128	0	1	1	Grand Piano KSP
129	0	40	1	Piano Strings
130	0	41	1	Dream
131	0	0	2	Bright Piano
132	0	1	2	Bright Piano KSP
133	0	0	3	Electric Grand
134	0	1	3	Electric Grand KSP
135	0	32	3	Detuned CP80
136	0	0	4	Honky-tonk Piano
137	0	1	4	Honky-tonk Piano KSP
138	0	0	5	Electric Piano 1
139	0	1	5	Electric Piano 1 KSP
140	0	32	5	Chorus Electric Piano 1
141	0	0	6	Electric Piano 2
142	0	1	6	Electric Piano 2 KSP
143	0	32	6	Chorus EP2
144	0	41	6	DX + Analog EP
145	0	0	7	Harpsichord
146	0	1	7	Harpsichord KSP
147	0	35	7	Harpsichord 3
148	0	0	8	Clavi
149	0	1	8	Clavi KSP
<b>CHROMATIC</b>				
150	0	0	9	Celesta
151	0	0	10	Glockenspiel
152	0	0	11	Music Box
153	0	64	11	Orgel
154	0	0	12	Vibraphone
155	0	1	12	Vibraphone KSP
156	0	0	13	Marimba
157	0	1	13	Marimba KSP
158	0	64	13	Sine Marimba

Voice No.	Bank Select		MIDI Program Change# (1 - 128)	Voice Name
	MSB (0 - 127)	LSB (0 - 127)		
159	0	97	13	Balimba
160	0	98	13	Log Drums
161	0	0	14	Xylophone
162	0	0	15	Tubular Bells
163	0	96	15	Church Bells
164	0	97	15	Carillon
165	0	0	16	Dulcimer
166	0	35	16	Dulcimer 2
167	0	96	16	Cimbalom
168	0	97	16	Santur
<b>ORGAN</b>				
169	0	0	17	Drawbar Organ
170	0	32	17	Detuned Drb Org
171	0	33	17	60s Drb Organ 1
172	0	34	17	60s Drb Organ 2
173	0	35	17	70s Drb Organ 1
174	0	37	17	60s Drb Organ 3
175	0	40	17	16+2'2/3
176	0	64	17	Organ Bass
177	0	65	17	70s Drb Organ 2
178	0	66	17	Cheezy Organ
179	0	67	17	Drawbar Organ 3
180	0	0	18	Percussive Organ
181	0	24	18	70s Perc Organ
182	0	32	18	Detuned Perc Org
183	0	33	18	Light Organ
184	0	37	18	Perc Organ 2
185	0	0	19	Rock Organ
186	0	64	19	Rotary Organ
187	0	65	19	Slow Rotary
188	0	66	19	Fast Rotary
189	0	0	20	Church Organ
190	0	32	20	Church Organ 3
191	0	35	20	Church Organ 2
192	0	40	20	Notre Dame
193	0	64	20	Organ Flute
194	0	65	20	Trem Organ Flute
195	0	0	21	Reed Organ
196	0	40	21	Puff Organ
197	0	0	22	Accordion
198	0	0	23	Harmonica
199	0	32	23	Harmonica 2
200	0	0	24	Tango Accordion
201	0	64	24	Tango Accordion 2
<b>GUITAR</b>				
202	0	0	25	Nylon Guitar
203	0	96	25	Ukulele
204	0	0	26	Steel Guitar
205	0	35	26	12-string Guitar
206	0	40	26	Nylon & Steel
207	0	41	26	Steel wth Body Sound
208	0	96	26	Mandolin
209	0	0	27	Jazz Guitar
210	0	32	27	Jazz Amp
211	0	0	28	Clean Guitar
212	0	32	28	Chorus Guitar
213	0	0	29	Muted Guitar
214	0	40	29	Funk Guitar 1
215	0	41	29	Muted Steel Guitar
216	0	45	29	Jazz Man
217	0	0	30	Overdriven
218	0	43	30	Guitar Pinch
219	0	0	31	Distortion
220	0	40	31	Feedback Guitar
221	0	41	31	Feedback Guitar 2
222	0	0	32	Guitar Harmonics
223	0	65	32	Guitar Feedback
224	0	66	32	Guitar Harmonics 2
<b>BASS</b>				
225	0	0	33	Acoustic Bass
226	0	40	33	Jazz Rhythm

Voice No.	Bank Select		MIDI Program Change# (1 - 128)	Voice Name
	MSB (0 - 127)	LSB (0 - 127)		
227	0	45	33	Velocity Crossfade Upright Bass
228	0	0	34	Finger Bass
229	0	18	34	Finger Dark
230	0	40	34	Bass & Distorted Electric Guitar
231	0	43	34	Finger Slap Bass
232	0	45	34	Finger Bass 2
233	0	65	34	Modulated Bass
234	0	0	35	Pick Bass
235	0	28	35	Muted Pick Bass
236	0	0	36	Fretless Bass
237	0	32	36	Fretless Bass 2
238	0	33	36	Fretless Bass 3
239	0	34	36	Fretless Bass 4
240	0	0	37	Slap Bass 1
241	0	32	37	Punch Thumb Bass
242	0	0	38	Slap Bass 2
243	0	43	38	Velocity SW Slap
244	0	0	39	Synth Bass 1
245	0	40	39	Techno Syn Bass
246	0	0	40	Synth Bass 2
247	0	6	40	Mellow Syn Bass
248	0	12	40	Sequenced Bass
249	0	18	40	Click Synth Bass
250	0	19	40	Syn Bass 2 Dark
251	0	40	40	Modular Syn Bass
252	0	41	40	DX Bass
<b>STRING</b>				
253	0	0	41	Violin
254	0	8	41	Slow Violin
255	0	0	42	Viola
256	0	0	43	Cello
257	0	0	44	Contrabass
258	0	0	45	Tremolo Strings
259	0	8	45	Slow Trem Strs
260	0	40	45	Suspense Strings
261	0	0	46	Pizzicato Strings
262	0	0	47	Orchestral Harp
263	0	40	47	Yang Chin
264	0	0	48	Timpani
<b>ENSEMBLE</b>				
265	0	0	49	Strings 1
266	0	3	49	Stereo Strings
267	0	8	49	Slow Strings
268	0	35	49	60's Strings
269	0	40	49	Orchestra
270	0	41	49	Orchestra 2
271	0	42	49	Trem Orchestra
272	0	45	49	Velocity Strings
273	0	0	50	Strings 2
274	0	3	50	Stereo Slow Strs
275	0	8	50	Legato Strings
276	0	40	50	Warm Strings
277	0	41	50	Kingdom
278	0	0	51	Synth Strings 1
279	0	0	52	Synth Strings 2
280	0	0	53	Choir Aahs
281	0	3	53	Stereo Choir
282	0	32	53	Mellow Choir
283	0	40	53	Choir Strings
284	0	0	54	Voice Oohs
285	0	0	55	Synth Voice
286	0	40	55	Synth Voice 2
287	0	41	55	Choral
288	0	64	55	Analog Voice
289	0	0	56	Orchestra Hit
290	0	35	56	Orchestra Hit 2
291	0	64	56	Impact
<b>BRASS</b>				
292	0	0	57	Trumpet
293	0	32	57	Warm Trumpet

Voice No.	Bank Select		MIDI Program Change# (1 - 128)	Voice Name
	MSB (0 - 127)	LSB (0 - 127)		
294	0	0	58	Trombone
295	0	18	58	Trombone 2
296	0	0	59	Tuba
297	0	0	60	Muted Trumpet
298	0	0	61	French Horn
299	0	6	61	French Horn Solo
300	0	32	61	French Horn 2
301	0	37	61	Horn Orchestra
302	0	0	62	Brass Section
303	0	35	62	Trp&Trb Section
304	0	0	63	Synth Brass 1
305	0	20	63	Reso Syn Brass
306	0	0	64	Synth Brass 2
307	0	18	64	Soft Brass
308	0	41	64	Choir Brass
<b>REED</b>				
309	0	0	65	Soprano Sax
310	0	0	66	Alto Sax
311	0	40	66	Sax Section
312	0	0	67	Tenor Sax
313	0	40	67	Breathy Tenor Sax
314	0	0	68	Baritone Sax
315	0	0	69	Oboe
316	0	0	70	English Horn
317	0	0	71	Bassoon
318	0	0	72	Clarinet
<b>PIPE</b>				
319	0	0	73	Piccolo
320	0	0	74	Flute
321	0	0	75	Recorder
322	0	0	76	Pan Flute
323	0	0	77	Blown Bottle
324	0	0	78	Shakuhachi
325	0	0	79	Whistle
326	0	0	80	Ocarina
<b>SYNTH LEAD</b>				
327	0	0	81	Square Lead
328	0	6	81	Square Lead 2
329	0	8	81	LM Square
330	0	18	81	Hollow
331	0	19	81	Shroud
332	0	64	81	Mellow
333	0	65	81	Solo Sine
334	0	66	81	Sine Lead
335	0	0	82	Sawtooth Lead
336	0	6	82	Sawtooth Lead 2
337	0	8	82	Thick Sawtooth
338	0	18	82	Dynamic Sawtooth
339	0	19	82	Digital Sawtooth
340	0	20	82	Big Lead
341	0	96	82	Sequenced Analog
342	0	0	83	Calliope Lead
343	0	65	83	Pure Pad
344	0	0	84	Chiff Lead
345	0	0	85	Charang Lead
346	0	64	85	Distorted Lead
347	0	0	86	Voice Lead
348	0	0	87	Fifths Lead
349	0	35	87	Big Five
350	0	0	88	Bass & Lead
351	0	16	88	Big & Low
352	0	64	88	Fat & Perky
353	0	65	88	Soft Whirl
<b>SYNTH PAD</b>				
354	0	0	89	New Age Pad
355	0	64	89	Fantasy
356	0	0	90	Warm Pad
357	0	0	91	Poly Synth Pad
358	0	0	92	Choir Pad
359	0	66	92	Itopia
360	0	0	93	Bowed Pad
361	0	0	94	Metallic Pad



Voice No.	Bank Select		MIDI Program Change# (1 - 128)	Voice Name
	MSB (0 - 127)	LSB (0 - 127)		
362	0	0	95	Halo Pad
363	0	0	96	Sweep Pad
<b>SYNTH EFFECTS</b>				
364	0	0	97	Rain
365	0	65	97	African Wind
366	0	66	97	Carib
367	0	0	98	Sound Track
368	0	27	98	Prologue
369	0	0	99	Crystal
370	0	12	99	Synth Drum Comp
371	0	14	99	Popcorn
372	0	18	99	Tiny Bells
373	0	35	99	Round Glocken
374	0	40	99	Glocken Chime
375	0	41	99	Clear Bells
376	0	42	99	Chorus Bells
377	0	65	99	Soft Crystal
378	0	70	99	Air Bells
379	0	71	99	Bell Harp
380	0	72	99	Gamelimba
381	0	0	100	Atmosphere
382	0	18	100	Warm Atmosphere
383	0	19	100	Hollow Release
384	0	40	100	Nylon E.Piano
385	0	64	100	Nylon Harp
386	0	65	100	Harp Vox
387	0	66	100	Atmosphere Pad
388	0	0	101	Brightness
389	0	0	102	Goblins
390	0	64	102	Goblins Synth
391	0	65	102	Creeper
392	0	67	102	Ritual
393	0	68	102	To Heaven
394	0	70	102	Night
395	0	71	102	Glisten
396	0	96	102	Bell Choir
397	0	0	103	Echoes
398	0	0	104	Sci-Fi
<b>WORLD</b>				
399	0	0	105	Sitar
400	0	32	105	Detuned Sitar
401	0	35	105	Sitar 2
402	0	97	105	Tamboura
403	0	0	106	Banjo
404	0	28	106	Muted Banjo
405	0	96	106	Rabab
406	0	97	106	Gopichant
407	0	98	106	Oud
408	0	0	107	Shamisen
409	0	0	108	Koto
410	0	96	108	Taisho-kin
411	0	97	108	Kanoon
412	0	0	109	Kalimba
413	0	0	110	Bagpipe
414	0	0	111	Fiddle
415	0	0	112	Shanai
<b>PERCUSSIVE</b>				
416	0	0	113	Tinkle Bell
417	0	96	113	Bonang
418	0	97	113	Altair
419	0	98	113	Gamelan Gongs
420	0	99	113	St Gamelan Gong
421	0	100	113	Rama Cymbal
422	0	0	114	Agogo
423	0	0	115	Steel Drums
424	0	97	115	Glass Percussion
425	0	98	115	Thai Bells
426	0	0	116	Woodblock
427	0	96	116	Castanets
428	0	0	117	Taiko Drum
429	0	96	117	Gran Cassa
430	0	0	118	Melodic Tom

Voice No.	Bank Select		MIDI Program Change# (1 - 128)	Voice Name
	MSB (0 - 127)	LSB (0 - 127)		
431	0	64	118	Melodic Tom 2
432	0	65	118	Real Tom
433	0	66	118	Rock Tom
434	0	0	119	Synth Drum
435	0	64	119	Analog Tom
436	0	65	119	Electronic Perc
437	0	0	120	Reverse Cymbal
<b>SOUND EFFECTS</b>				
438	0	0	121	Fret Noise
439	0	0	122	Breath Noise
440	0	0	123	Seashore
441	0	0	124	Bird Tweet
442	0	0	125	Telephone Ring
443	0	0	126	Helicopter
444	0	0	127	Applause
445	0	0	128	Gunshot
446	64	0	1	Cutting Noise
447	64	0	2	Cutting Noise 2
448	64	0	4	String Slap
449	64	0	17	Flute Key Click
450	64	0	33	Shower
451	64	0	34	Thunder
452	64	0	35	Wind
453	64	0	36	Stream
454	64	0	37	Bubble
455	64	0	38	Feed
456	64	0	49	Dog
457	64	0	50	Horse
458	64	0	51	Bird Tweet 2
459	64	0	56	Maou
460	64	0	65	Phone Call
461	64	0	66	Door Squeak
462	64	0	67	Door Slam
463	64	0	68	Scratch Cut
464	64	0	69	Scratch Split
465	64	0	70	Wind Chime
466	64	0	71	Telephone Ring 2
467	64	0	81	Engine Ignition
468	64	0	82	Tires Squeal
469	64	0	83	Passing
470	64	0	84	Car Crash
471	64	0	85	Siren
472	64	0	86	Train
473	64	0	87	Jet Plane
474	64	0	88	Starship
475	64	0	89	Burst
476	64	0	90	Roller Coaster
477	64	0	91	Submarine
478	64	0	97	Laugh
479	64	0	98	Scream
480	64	0	99	Punch
481	64	0	100	Heartbeat
482	64	0	101	Footsteps
483	64	0	113	Machine Gun
484	64	0	114	Laser Gun
485	64	0	115	Explosion
486	64	0	116	Firework

# Drum Kit List

- “ ” indicates that the drum sound is the same as “Standard Kit 1”.
- Each percussion voice uses one note.
- The MIDI Note # and Note are actually one octave lower than keyboard Note # and Note. For example, in “115: Standard Kit 1”, the “Seq Click H” (Note# 36/Note C1) corresponds to (Note# 24/Note C0).
- Key Off: Keys marked “O” stop sounding the instant they are released.
- Voices with the same Alternate Note Number (\*1 ... 4) cannot be played simultaneously. (They are designed to be played alternately with each other.)

	Voice No.						115	116	117	118	119	120
	MSB (0 - 127) / LSB (0 - 127) / PC (1 - 128)						127/000/001	127/000/002	127/000/009	127/000/017	127/000/025	127/000/026
	Keyboard	MIDI		Key	Alternate	assign	Standard Kit 1	Standard Kit 2	Room Kit	Rock Kit	Electronic Kit	Analog Kit
Note#	Note	Note#	Note	Off								
	25	C#	0	13	C#	-1						
	26	D	0	14	D	-1						
	27	D#	0	15	D#	-1						
	28	E	0	16	E	-1						
	29	F	0	17	F	-1						
	30	F#	0	18	F#	-1						
	31	G	0	19	G	-1						
	32	G#	0	20	G#	-1						
	33	A	0	21	A	-1						
	34	A#	0	22	A#	-1						
	35	B	0	23	B	-1						
	36	C	1	24	C	0						
	37	C#	1	25	C#	0						
C1	38	D	1	26	D	0	O					
D1	39	D#	1	27	D#	0						
E1	40	E	1	28	E	0	O					
F1	41	F	1	29	F	0	O				Reverse Cymbal	Reverse Cymbal
F#1	42	F#	1	30	F#	0					Hi Q 2	Hi Q 2
G1	43	G	1	31	G	0					SD Rock H	SD Rock H
G#1	44	G#	1	32	G#	0						
A1	45	A	1	33	A	0					Bass Drum H	Bass Drum H
A#1	46	A#	1	34	A#	0						
B1	47	B	1	35	B	0					Bass Drum H	BD Rock
C2	48	C	2	36	C	1					BD Gate	BD Analog L
C#2	49	C#	2	37	C#	1						BD Analog H
D2	50	D	2	38	D	1						Analog Side Stick
D#2	51	D#	2	39	D#	1						Analog Snare 1
E2	52	E	2	40	E	1						
F2	53	F	2	41	F	1						
F#2	54	F#	2	42	F#	1	1					Analog Snare 2
G2	55	G	2	43	G	1						Analog Tom 1
G#2	56	G#	2	44	G#	1	1					Analog Tom 1
A2	57	A	2	45	A	1						Analog HH Closed 1
A#2	58	A#	2	46	A#	1	1					Analog Tom 2
B2	59	B	2	47	B	1						Analog Tom 2
C3	60	C	3	48	C	2						Analog HH Closed 2
C#3	61	C#	3	49	C#	2						Analog Tom 3
D3	62	D	3	50	D	2						Analog HH Open
D#3	63	D#	3	51	D#	2						Analog Tom 4
E3	64	E	3	52	E	2						Analog Tom 4
F3	65	F	3	53	F	2						Analog Tom 5
F#3	66	F#	3	54	F#	2						Analog Tom 5
G3	67	G	3	55	G	2						Analog Cymbal
G#3	68	G#	3	56	G#	2						Analog Tom 6
A3	69	A	3	57	A	2						Analog Tom 6
A#3	70	A#	3	58	A#	2						
B3	71	B	3	59	B	2						
C4	72	C	4	60	C	3						
C#4	73	C#	4	61	C#	3						
D4	74	D	4	62	D	3						Analog Conga H
D#4	75	D#	4	63	D#	3						Analog Conga M
E4	76	E	4	64	E	3						Analog Conga L
F4	77	F	4	65	F	3						
F#4	78	F#	4	66	F#	3						
G4	79	G	4	67	G	3						
G#4	80	G#	4	68	G#	3						
A4	81	A	4	69	A	3						
A#4	82	A#	4	70	A#	3						Analog Maracas
B4	83	B	4	71	B	3	O					
C5	84	C	5	72	C	4	O					
C#5	85	C#	5	73	C#	4						
D5	86	D	5	74	D	4	O					
D#5	87	D#	5	75	D#	4						Analog Claves
E5	88	E	5	76	E	4						
F5	89	F	5	77	F	4						
F#5	90	F#	5	78	F#	4					Scratch Push	Scratch Push
G5	91	G	5	79	G	4					Scratch Pull	Scratch Pull
G#5	92	G#	5	80	G#	4						
A5	93	A	5	81	A	4	2					
A#5	94	A#	5	82	A#	4	2					
B5	95	B	5	83	B	4						
C6	96	C	6	84	C	5						
	97	C#	6	85	C#	5						
	98	D	6	86	D	5						
	99	D#	6	87	D#	5						
	100	E	6	88	E	5						
	101	F	6	89	F	5						
	102	F#	6	90	F#	5						
	103	G	6	91	G	5						

		Voice No.					115	121	122	123	124	125	126	
		MSB (0 - 127) / LSB (0 - 127) / PC (1 - 128)					127/000/001	127/000/028	127/000/033	127/000/041	127/000/049	126/000/001	126/000/002	
		MIDI					Standard Kit 1	Dance Kit	Jazz Kit	Brush Kit	Symphony Kit	SFX Kit 1	SFX Kit 2	
		Note#	Note	Note#	Note	Key Off	Alternate assign							
		25	C# 0	13	C# -1		3	Surdo Mute						
		26	D 0	14	D -1		3	Surdo Open						
		27	D# 0	15	D# -1			Hi Q						
		28	E 0	16	E -1			Whip Slap						
		29	F 0	17	F -1		4	Scratch Push						
		30	F# 0	18	F# -1		4	Scratch Pull						
		31	G 0	19	G -1			Finger Snap						
		32	G# 0	20	G# -1			Click Noise						
		33	A 0	21	A -1			Metronome Click						
		34	A# 0	22	A# -1			Metronome Bell						
		35	B 0	23	B -1			Seq Click L						
		36	C 1	24	C 0			Seq Click H						
C1	C#1	37	C# 1	25	C# 0			Brush Tap						
D1	D#1	38	D 1	26	D 0	O		Brush Swirl						
E1	E#1	39	D# 1	27	D# 0			Brush Slap						
F1	F#1	40	E 1	28	E 0	O		Brush Tap Swirl	Reverse Cymbal					
G1	G#1	41	F 1	29	F 0	O		Snare Roll						
A1	A#1	42	F# 1	30	F# 0			Castanet	Hi Q 2					
B1	B#1	43	G 1	31	G 0			Snare H Soft	AnSD Snappy	SD Jazz H Light	Brush Slap L			
C2	C#2	44	G# 1	32	G# 0			Sticks						
D2	D#2	45	A 1	33	A 0			Bass Drum Soft	AnBD Dance-1			Bass Drum L		
E2	E#2	46	A# 1	34	A# 0			Open Rim Shot	AnSD OpenRim					
F2	F#2	47	B 1	35	B 0			Bass Drum Hard	AnBD Dance-2			Gran Cassa		
G2	G#2	48	C 2	36	C 1			Bass Drum	AnBD Dance-3	BD Jazz	BD Jazz	Gran Cassa Mute	Cutting Noise	Phone Call
A2	A#2	49	C# 2	37	C# 1			Side Stick	Analog Side Stick				Cutting Noise 2	Door Squeak
B2	B#2	50	D 2	38	D 1			Snare M	AnSD Q	SD Jazz L	Brush Slap	Marching Sn M		Door Slam
C3	C#3	51	D# 2	39	D# 1			Hand Clap					String Slap	Scratch Cut
D3	D#3	52	E 2	40	E 1			Snare H Hard	AnSD Ana+Acoustic	SD Jazz M	Brush Tap	Marching Sn H		Scratch
E3	E#3	53	F 2	41	F 1			Floor Tom L	Analog Tom 1	Jazz Tom 1	Brush Tom 1	Jazz Tom 1		Wind Chime
F3	F#3	54	F# 2	42	F# 1	1		Hi-Hat Closed	Analog HH Closed 3					Telephone Ring 2
G3	G#3	55	G 2	43	G 1			Floor Tom H	Analog Tom 2	Jazz Tom 2	Brush Tom 2	Jazz Tom 2		
A3	A#3	56	G# 2	44	G# 1	1		Hi-Hat Pedal	Analog HH Closed 4					
B3	B#3	57	A 2	45	A 1			Low Tom	Analog Tom 3	Jazz Tom 3	Brush Tom 3	Jazz Tom 3		
C4	C#4	58	A# 2	46	A# 1	1		Hi-Hat Open	Analog HH Open 2					
D4	D#4	59	B 2	47	B 1			Mid Tom L	Analog Tom 4	Jazz Tom 4	Brush Tom 4	Jazz Tom 4		
E4	E#4	60	C 3	48	C 2			Mid Tom H	Analog Tom 5	Jazz Tom 5	Brush Tom 5	Jazz Tom 5		
F4	F#4	61	C# 3	49	C# 2			Crash Cymbal 1	Analog Cymbal				Hand Cym. L	
G4	G#4	62	D 3	50	D 2			High Tom	Analog Tom 6	Jazz Tom 6	Brush Tom 6	Jazz Tom 6		
A4	A#4	63	D# 3	51	D# 2			Ride Cymbal 1				Hand Cym.Short L		
B4	B#4	64	E 3	52	E 2			Chinese Cymbal					Flute Key Click	Car Engine Ignition
C5	C#5	65	F 3	53	F 2			Ride Cymbal Cup						Car Tires Squeal
D5	D#5	66	F# 3	54	F# 2			Tambourine						Car Passing
E5	E#5	67	G 3	55	G 2			Splash Cymbal						Car Crash
F5	F#5	68	G# 3	56	G# 2			Cowbell	Analog Cowbell					Siren
G5	G#5	69	A 3	57	A 2			Crash Cymbal 2				Hand Cym. H		Train
A5	A#5	70	A# 3	58	A# 2			Vibraslap						Jet Plane
B5	B#5	71	B 3	59	B 2			Ride Cymbal 2				Hand Cym.Short H		Starship
C6	C#6	72	C 4	60	C 3			Bongo H						Burst
D6	D#6	73	C# 4	61	C# 3			Bongo L						Roller Coaster
E6	E#6	74	D 4	62	D 3			Conga H Mute	Analog Conga H					Submarine
F6	F#6	75	D# 4	63	D# 3			Conga H Open	Analog Conga M					
G6	G#6	76	E 4	64	E 3			Conga L	Analog Conga L					
A6	A#6	77	F 4	65	F 3			Timbale H						
B6	B#6	78	F# 4	66	F# 3			Timbale L						
C7	C#7	79	G 4	67	G 3			Agogo H						
D7	D#7	80	G# 4	68	G# 3			Agogo L					Shower	Laugh
E7	E#7	81	A 4	69	A 3			Cabasa					Thunder	Scream
F7	F#7	82	A# 4	70	A# 3			Maracas	Analog Maracas				Wind	Punch
G7	G#7	83	B 4	71	B 3	O		Samba Whistle H					Stream	Heartbeat
A7	A#7	84	C 5	72	C 4	O		Samba Whistle L					Bubble	FootSteps
B7	B#7	85	C# 5	73	C# 4			Guiro Short				Feed		
C8	C#8	86	D 5	74	D 4	O		Guiro Long						
D8	D#8	87	D# 5	75	D# 4			Claves	Analog Claves					
E8	E#8	88	E 5	76	E 4			Wood Block H						
F8	F#8	89	F 5	77	F 4			Wood Block L						
G8	G#8	90	F# 5	78	F# 4			Cuica Mute	Scratch Push					
A8	A#8	91	G 5	79	G 4			Cuica Open	Scratch Pull					
B8	B#8	92	G# 5	80	G# 4		2	Triangle Mute						
C9	C#9	93	A 5	81	A 4		2	Triangle Open						
D9	D#9	94	A# 5	82	A# 4			Shaker						
E9	E#9	95	B 5	83	B 4			Jingle Bell						
F9	F#9	96	C 6	84	C 5			Bell Tree					Dog	Machine Gun
G9	G#9	97	C# 6	85	C# 5								Horse	Laser Gun
A9	A#9	98	D 6	86	D 5								Bird Tweet 2	Explosion
B9	B#9	99	D# 6	87	D# 5									Firework
C10	C#10	100	E 6	88	E 5									
D10	D#10	101	F 6	89	F 5									
E10	E#10	102	F# 6	90	F# 5									
F10	F#10	103	G 6	91	G 5							Maou		

# Style List

Style No.	Style Name
<b>8BEAT</b>	
001	8BeatModern
002	60'sGtrPop
003	8BeatAdria
004	60's8Beat
005	8Beat
006	OffBeat
007	60'sRock
008	HardRock
009	RockShuffle
010	8BeatRock
<b>16BEAT</b>	
011	16Beat
012	PopShuffle1
013	PopShuffle2
014	GuitarPop
015	16BtUptempo
016	KoolShuffle
017	JazzRock
018	HipHopLight
<b>BALLAD</b>	
019	PianoBallad
020	LoveSong
021	6/8ModernEP
022	6/8SlowRock
023	OrganBallad
024	PopBallad
025	16BeatBallad1
026	16BeatBallad2
<b>DANCE</b>	
027	EuroTrance
028	Ibiza
029	HouseMusik
030	SwingHouse
031	TechnoPolis
032	Clubdance
033	ClubLatin
034	Garage1
035	Garage2
036	TechnoParty
037	UKPop
038	HipHopGroove
039	HipShuffle
040	HipHopPop
<b>DISCO</b>	
041	70'sDisco1
042	70'sDisco2
043	LatinDisco
044	DiscoPhilly
045	SaturdayNight
046	DiscoChocolate
047	DiscoHands

Style No.	Style Name
<b>SWING&amp;JAZZ</b>	
048	BigBandFast
049	BigBandMedium
050	BigBandBallad
051	BigBandShuffle
052	JazzClub
053	Swing1
054	Swing2
055	Five/Four
056	JazzBallad
057	Dixieland
058	Ragtime
059	AfroCuban
060	Charleston
<b>R&amp;B</b>	
061	Soul
062	DetroitPop1
063	60'sRock&Roll
064	6/8Soul
065	CrocoTwist
066	Rock&Roll
067	DetroitPop2
068	BoogieWoogie
069	ComboBoogie
070	6/8Blues
<b>COUNTRY</b>	
071	Country8Beat
072	CountryPop
073	CountrySwing
074	Country2/4
075	CowboyBoogie
076	CountryShuffle
077	Bluegrass
<b>LATIN</b>	
078	BrazilianSamba
079	BossaNova
080	PopBossa
081	Tijuana
082	DiscoLatin
083	Mambo
084	Salsa
085	Beguine
086	GypsyRumba
087	RmbFlamenca
088	Rumbalsland
089	Reggae
<b>BALLROOM</b>	
090	VienneseWaltz
091	EnglishWaltz
092	Slowfox
093	Foxtrot
094	Quickstep

Style No.	Style Name
095	Tango
096	Pasodoble
097	Samba
098	ChaChaCha
099	Rumba
100	Jive
<b>TRADITIONAL</b>	
101	USMarch
102	6/8March
103	GermanMarch
104	PolkaPop
105	OberPolka
106	Tarantella
107	Showtune
108	ChristmasSwing
109	ChristmasWaltz
110	ScottishReel
111	Hawaiian
<b>WALTZ</b>	
112	GuitarSerenade
113	SwingWaltz
114	JazzWaltz1
115	JazzWaltz2
116	CountryWaltz
117	OberWalzer
118	Musette
<b>DJ</b>	
119	DJ-HipHop
120	DJ-DanceSwing
121	DJ-House
122	DJ-GarageHouse
123	DJ-PopR&B
<b>PIANIST</b>	
124	Stride
125	PianoSwing
126	PianoRag
127	Arpeggio
128	Musical
129	Habanera
130	SlowRock
131	8BtPianoBallad
132	PianoMarch
133	6/8PianoMarch
134	PianoWaltz
135	PianoBeguine

# Song List

No.	Song Name
<b>FAVORITES (Lyrics)</b>	
001	Against All Odds (A. Jamal/R. McNair)
002	Englishman In New York (Sting)
003	Can't Help Falling In Love (G.D.Weiss,H.Peretti and L.Creatore)
004	A Hard Day's Night (J.Lennon and P.McCartney )
005	Stella By Starlight (V.Young)
<b>FAVORITES</b>	
006	Bill Bailey (Won't You Please Come Home) (H. Cannon)
007	When Irish Eyes Are Smiling (E.R. Ball)
008	Down By The Riverside (Traditional)
009	America The Beautiful (S.A. Ward)
010	When The Saints Go Marchin' In (Traditional )
<b>ORCHESTRA</b>	
011	Frühlingsstimmen (J. StraussII)
012	Danse Des Mirlitons (From "The Nutcracker") (P.I. Tchaikovsky)
013	"Orphée Aux Enfers" Overture (J. Offenbach)
014	Slavonic Dances No.10 (A. Dvořák)
015	La Primavera (From "Le Quattro Stagioni") (A. Vivaldi)
016	Méditation De Thais (J. Massenet)
017	Guillaume Tell (G. Rossini)
018	Camptown Races (S.C. Foster)
019	Frühlingslied (F. Mendelssohn)
020	Ungarische Tänze Nr.5 (J. Brahms)
<b>PIANIST</b>	
021	La Candeur (J.F.Burgmüller)
022	Arabesque (J.F.Burgmüller)
023	Pastorale (J.F.Burgmüller)
024	Petite Réunion (J.F.Burgmüller)
025	Innocence (J.F.Burgmüller)
026	Progrès (J.F.Burgmüller)
027	La Chevaleresque (J.F.Burgmüller)
028	Turkish March (W.A. Mozart)
029	Valse Op.64-1 "Peiti Chien" (F.Chopin)
030	Menuett (L. Boccherini)
031	Moments Musicaux Op.94-3 (F. Schubert)
032	The Entertainer (S. Joplin)
033	Prelude (Wohltemperierte Klavier 1-1) (J.S. Bach)
034	La Violette (Streabbog)
035	Für Elise (L.v. Beethoven)
<b>PRACTICE</b>	
036	Little Brown Jug (Traditional)
037	Loch Lomond (Traditional)
038	Oh! Susanna (S.C. Foster)
039	Greensleeves (Traditional)
040	Aura Lee (G. Poulton)
041	Londonderry Air (Traditional)
042	Ring De Banjo (S.C. Foster)
043	Wenn Ich Ein Vöglein Wär ? (Traditional)
044	Die Lorelei (F. Silcher)
045	Funiculi-Funicula (L. Denza)
046	Turkey In The Straw (Traditional)
047	Old Folks At Home (S.C. Foster)
048	Silent Night (F. Gruber)
049	Jingle Bells (J.S. Pierpont)
050	Muss I Denn (F. Silcher)

No.	Song Name
051	Liebesträume Nr.3 (F. Liszt)
052	Jesu, Joy Of Man's Desiring (J.S. Bach)
053	Symphonie Nr.9 (L.v. Beethoven)
054	Song Of The Pearl Fisher (G. Bizet)
055	Gavotte (F.J. Gossec)
056	String Quartet No.17 2nd Mov. "Serenade" (F.J. Haydn)
057	Menuett (J.S. Bach)
058	Canon (J. Pachelbel)
059	The Danube Waves (I. Ivanovici)
060	From "The Magic Flute" (W.A Mozart)
061	Piano Sonate Op.27-2 "Mondschein" (L.v. Beethoven)
062	"The Surprise" Symphony (F.J. Haydn)
063	To A Wild Rose (E.A. MacDowell)
064	Air de Toréador "Carmen" (G. Bizet)
065	O Mio Babbino Caro (From "Gianni Schicchi") (G. Puccini)
<b>DUET</b>	
066	Three Blind Mice (Traditional)
067	Row Row Row Your Boat (Traditional)
068	On Top Of Old Smoky (Traditional)
069	We Wish You A Merry Christmas (Traditional)
070	Scarborough Fair (Traditional)
071	Im Mai (Traditional)
072	O Christmas Tree (Traditional)
073	Mary Had A Little Lamb (Traditional)
074	Ten Little Indians (Septimus Winner)
075	Pop Goes The Weasel (Traditional)
076	Twinkle Twinkle Little Star (Traditional)
077	Close Your Hands, Open Your Hands (J.J. Rousseau)
078	The Cuckoo (Traditional)
079	O Du Lieber Augustin (Traditional)
080	London Bridge (Traditional)
<b>CHORD LESSON</b>	
081	Twinkle Twinkle Little Star (Traditional)
082	Close Your Hands, Open Your Hands (J.J. Rousseau)
083	The Cuckoo (Traditional)
084	O Du Lieber Augustin (Traditional)
085	London Bridge (Traditional)
086	American Patrol (F.W. Meacham)
087	Beautiful Dreamer (S.C. Foster)
088	Battle Hymn Of The Republic (Traditional)
089	Home Sweet Home (H. Bishop)
090	Valse Des Fleurs (From "The Nutcracker") (P.I. Tchaikovsky)
091	Aloha Oe (Traditional)
092	I've Been Working On The Railroad (Traditional)
093	My Darling Clementine (Traditional)
094	Auld Lang Syne (Traditional)
095	Grandfather's Clock (H.C. Work)
096	Amazing Grace (Traditional)
097	My Bonnie (Traditional)
098	Yankee Doodle (Traditional)
099	Joy To The World (G.F. Händel)
100	Ave Maria (F.Schubert)



**NOTE:**

\*1 By default (factory settings) the instrument ordinarily functions as a 16-channel multi-timbral tone generator, and incoming data does not affect the panel voices or panel settings. However, the MIDI messages listed below do affect the panel voices, auto accompaniment, and songs.

- MIDI Master Tuning
- System exclusive messages for changing the Reverb Type and Chorus Type.

\*2 Messages for these control change numbers cannot be transmitted from the instrument itself. However, they may be transmitted when playing the accompaniment, song or using the Harmony effect.

\*3 Exclusive

<GM System ON> F0H, 7EH, 7FH, 09H, 01H, F7H  
 • This message automatically restores all default settings for the instrument, with the exception of MIDI Master Tuning.

<MIDI Master Volume> F0H, 7FH, 7FH, 04H, 01H, II, mm, F7H  
 • This message allows the volume of all channels to be changed simultaneously (Universal System Exclusive).  
 • The values of "mm" is used for MIDI Master Tuning. (Values for "II" are ignored.)

<MIDI Master Tuning> F0H, 43H, 1nH, 27H, 30H, 00H, 00H, mm, II, cc, F7H  
 • This message simultaneously changes the tuning value of all channels.  
 • The values of "mm" and "II" are used for MIDI Master Tuning.  
 • The default value of "mm" and "II" are 08H and 00H, respectively. Any values can be used for "n" and "cc."

<Reverb Type> F0H, 43H, 1nH, 4CH, 02H, 01H, 00H, mmH, IIH, F7H

- mm : Reverb Type MSB
  - II : Reverb Type LSB
- Refer to the Effect Map (page 95) for details.

<Chorus Type> F0H, 43H, 1nH, 4CH, 02H, 01H, 20H, mmH, IIH, F7H

- mm : Chorus Type MSB
  - II : Chorus Type LSB
- Refer to the Effect Map (page 95) for details.

\*4 When the accompaniment is started, an FAH message is transmitted. When accompaniment is stopped, an FCH message is transmitted. When the clock is set to External, both FAH (accompaniment start) and FCH (accompaniment stop) are recognized.

\*5 Local ON/OFF

<Local ON> Bn, 7A, 7F  
 <Local OFF> Bn, 7A, 00  
 Value for "n" is ignored.

■ **Effect map**

- \* When a Type LSB value is received that corresponds to no effect type, a value corresponding to the effect type (coming the closest to the specified value) is automatically set.
- \* The numbers in parentheses in front of the Effect Type names correspond to the number indicated in the display.

● **REVERB**

TYPE MSB	TYPE LSB									
	00	01	02	08	16	17	18	19	20	
000	No Effect									
001	(01)Hall1				(02)Hall2	(03)Hall3				
002	Room					(04)Room1		(05)Room2		
003	Stage				(06)Stage1	(07)Stage2				
004	Plate				(08)Plate1	(09)Plate2				
005...127	No Effect									

● **CHORUS**

TYPE MSB	TYPE LSB									
	00	01	02	08	16	17	18	19	20	
000...063	No Effect									
064	Thru									
065	Chorus		(02)Chorus2							
066	Celeste					(01)Chorus1				
067	Flanger			(03)Flanger1		(04)Flanger2				
068...127	No Effect									

## Panel controls and terminals

+/-	16, 19, 39
▶▶	16, 21
◀◀	16, 21
	16, 21
↙	39
A ↔ B	16, 21, 56
▶/■	16
0 - 9	16, 19, 39
ACMP ON/OFF	16, 30, 47
BANK	16, 52
Card Slot	16
CATEGORY ▲/▼	16, 19, 39, 77
DC IN 12V	16
DEMO	16, 18
Dial	16, 19, 39
DICTIONARY	16, 50
DUAL	16, 28, 40
EASY SONG ARRANGER	16, 39, 57
EXECUTE	16, 62
EXIT	16, 39
FILE CONTROL	16, 58, 62
FUNCTION	16, 77, 84
HARMONY	16, 44
INTRO/ENDING/rit.	16, 30, 31, 33
KARAOKE	16, 23, 54
LCD CONTRAST	16, 38
LESSON L, LESSON R	16, 34
MAIN/AUTO FILL	16, 31
MASTER VOLUME	15, 16, 38
MEMORY	16, 53
METRONOME	16, 28, 42
MIC	12, 16
MIC VOLUME	12, 16, 23
OUTPUT R, L	14, 16
PC	16, 69
PERFORMANCE ASSISTANT	16
PHONES	14, 16
PORTABLE GRAND	16, 28, 40
REC	60
REC, 1 - 5, A	16
REGISTRATION MEMORY	16
SCORE	16, 25, 54
SONG	16, 19, 39
SONG MEMORY	16
SPLIT	16, 28, 41
STANDBY/ON	15, 16
START/STOP	16, 32, 33
STYLE	16, 30, 39
SUSTAIN	14, 16
SYNC START	16, 31, 32, 33
SYNC STOP	16, 32
TEMPO/TAP	16, 32
TOUCH	16, 29, 43
TRANSPOSE	16, 24
USB	14, 16
VOICE	16, 26, 39

## Alphabetical order

<b>O</b>	
000 - OTS	28
<b>A</b>	
Accessories (Optional)	85
Accessories (Supplied)	8, 85
ACMP	38
Acrobat Reader	72, 74
Auto Accompaniment	47
Auto Accompaniment Area	31
AWM	9
<b>B</b>	
Backup	84
Battery	4, 10
<b>C</b>	
Cable Holder	16
CD-ROM	8, 71
Channel Message	67
Chord	38, 48, 51
CHORD ROOT	50
CHORD TYPE	50
Chorus	29, 45, 78, 95
Chorus Type	45, 46
Computer	14, 67, 69
<b>D</b>	
D. Chorus Level	78
D. Octave	78
D. Pan	78
D. Reverb Level	78
D. Volume	78
D-Cancel	79
Default Setting	77
Delete	65
Demo	7, 18
Dictionary	9, 50
Display	8, 38
Download	70
Drum Kit	27
Drum Kit List	90
Dual	38, 40
Dual Voice	28, 40
<b>E</b>	
Easy Song Arranger	9, 57
Easy Song Arranger MAIN	57
Effect Map	95
Effect Type List	46
External Clock	68, 79

<b>F</b>	
File	62
File Control	38
File Name	64
Fingered	48
Foot Switch	14
Format	62
Function	77
Function Display	77
<b>G</b>	
GM System Level 1	7
Grade	35, 79
<b>H</b>	
Harmony	29, 38, 44
Harmony Type	44, 46, 78
Harmony Volume	44, 78
Headphones	14
<b>I</b>	
Initial Send	68, 79
<b>K</b>	
Karaoke	9, 22
KeyboardOut	68, 79
<b>L</b>	
Language	79
Lesson	9, 34, 55, 70
Load	63
Local	67, 79
LOW BATTERY!!	38
L-Part	79
LSB Receive Cancel	68
Lyric	9, 54
<b>M</b>	
M. Chorus Level	78
M. Octave	78
M. Pan	78
M. Reverb Level	78
M. Volume	78
MAIN	40
MAIN Display	38
Main Voice	26, 40
Measure	38
Melody	24
Melody Notation	25, 54
Melody Voice	24, 55
Memory Card	5, 8, 11



- Messages ..... 82  
 Metronome ..... 28, 42  
 Metronome Volume ..... 43, 79  
 Mic Echo ..... 20, 24, 79  
 Mic Volume ..... 24, 79  
 Microphone ..... 8, 12, 13, 20, 24  
 Microphone Holder ..... 12, 13  
 Microphone Holder Cap ..... 8, 12  
 MIDI ..... 66, 69  
 MIDI Implementation Chart ..... 94  
 Music Rest ..... 8, 15
- N**
- Notation ..... 25, 70
- O**
- OMS ..... 75  
 Open Music System (OMS) ..... 74
- P**
- PC Mode ..... 69, 78  
 Percussion ..... 47  
 Performance assistant technology .... 9, 18  
 Piano-Style Notation ..... 25, 54  
 Power Adaptor ..... 4, 10  
 Preset Song ..... 54
- Q**
- Quantize ..... 54, 79
- R**
- REC ..... 38  
 Recording ..... 59  
 Registration Memory ..... 38, 52, 63  
 Remote control ..... 69  
 Repeat ..... 21, 38, 56  
 Reverb ..... 29, 45, 78, 95  
 Reverb Type ..... 45, 46  
 R-Part ..... 79
- S**
- S. Chorus Level ..... 78  
 S. Octave ..... 78  
 S. Pan ..... 78  
 S. Reverb Level ..... 78  
 S. Volume ..... 78  
 Single Finger ..... 48  
 SmartMedia Card  
 ..... 5, 8, 9, 11, 12, 52, 58, 62  
 SmartMedia Card Song ..... 54  
 SMF (Standard MIDI File) ..... 54, 64  
 SMF Save ..... 64  
 Software Licensing Agreement ..... 76  
 Song ..... 38  
 Song Clear ..... 61  
 Song Filer ..... 70, 73, 75  
 Song List ..... 19, 93  
 Song Memory ..... 56  
 Song Volume ..... 55, 78  
 SongOut ..... 68, 79  
 Specifications ..... 85  
 Split ..... 38, 41  
 Split Point ..... 41, 42, 48, 78  
 Split Voice ..... 28, 41  
 Style ..... 38, 47  
 Style File ..... 47  
 Style List ..... 30, 92  
 Style Number 136 ..... 47  
 Style Volume ..... 47, 78  
 StyleOut ..... 68, 79  
 System Message ..... 67
- T**
- Tempo ..... 20, 38, 42  
 Time Signature ..... 43, 79  
 Touch ..... 43  
 Touch Response ..... 9, 29, 38, 43  
 Touch Sense ..... 43, 78  
 Track ..... 38, 56  
 Track Clear ..... 61  
 Transpose ..... 24, 29, 38  
 Troubleshooting ..... 80  
 Tuning ..... 29, 78
- U**
- USB ..... 7, 67  
 USB MIDI Driver ..... 70, 72, 74  
 User Data ..... 63  
 User Delete ..... 65  
 User File Save ..... 63  
 User Song ..... 54, 59, 63  
 User Style ..... 63
- V**
- Voice ..... 26, 38  
 Voice List ..... 26, 27, 86
- X**
- XF ..... 7  
 XG Voice List ..... 87  
 XGlite ..... 7

# Limited Warranty

**90 DAYS LABOR**

**1 YEAR PARTS**

Yamaha Corporation of America, hereafter referred to as Yamaha, warrants to the original consumer of a product included in the categories listed below, that the product will be free of defects in materials and/or workmanship for the periods indicated. This warranty is applicable to all models included in the following series of products:

## **PSR SERIES OF PORTATONE ELECTRONIC KEYBOARDS**

If during the first 90 days that immediately follows the purchase date, your new Yamaha product covered by this warranty is found to have a defect in material and/or workmanship, Yamaha and/or its authorized representative will repair such defect without charge for parts or labor.

If parts should be required after this 90 day period but within the one year period that immediately follows the purchase date, Yamaha will, subject to the terms of this warranty, supply these parts without charge. However, charges for labor, and/or any miscellaneous expenses incurred are the consumers responsibility. Yamaha reserves the right to utilize reconditioned parts in repairing these products and/or to use reconditioned units as warranty replacements.

**THIS WARRANTY IS THE ONLY EXPRESS WARRANTY WHICH YAMAHA MAKES IN CONNECTION WITH THESE PRODUCTS. ANY IMPLIED WARRANTY APPLICABLE TO THE PRODUCT, INCLUDING THE WARRANTY OF MERCHANT ABILITY IS LIMITED TO THE DURATION OF THE EXPRESS WARRANTY. YAMAHA EXCLUDES AND SHALL NOT BE LIABLE IN ANY EVENT FOR INCIDENTAL OR CONSEQUENTIAL DAMAGES.**

Some states do not allow limitations that relate to implied warranties and/or the exclusion of incidental or consequential damages. Therefore, these limitations and exclusions may not apply to you.

This warranty gives you specific legal rights. You may also have other rights which vary from state to state.

## **CONSUMERS RESPONSIBILITIES**

If warranty service should be required, it is necessary that the consumer assume certain responsibilities:

1. Contact the Customer Service Department of the retailer selling the product, or any retail outlet authorized by Yamaha to sell the product for assistance. You may also contact Yamaha directly at the address provided below.
2. Deliver the unit to be serviced under warranty to: the retailer selling the product, an authorized service center, or to Yamaha with an explanation of the problem. Please be prepared to provide proof purchase date (sales receipt, credit card copy, etc.) when requesting service and/or parts under warranty.
3. Shipping and/or insurance costs are the consumers responsibility.\* Units shipped for service should be packed securely.

\*Repaired units will be returned PREPAID if warranty service is required within the first 90 days.

**IMPORTANT:** Do NOT ship anything to ANY location without prior authorization. A Return Authorization (RA) will be issued that has a tracking number assigned that will expedite the servicing of your unit and provide a tracking system if needed.

4. Your owners manual contains important safety and operating instructions. It is your responsibility to be aware of the contents of this manual and to follow all safety precautions.

## **EXCLUSIONS**

This warranty does not apply to units whose trade name, trademark, and/or ID numbers have been altered, defaced, exchanged removed, or to failures and/or damages that may occur as a result of:

1. Neglect, abuse, abnormal strain, modification or exposure to extremes in temperature or humidity.
2. Improper repair or maintenance by any person who is not a service representative of a retail outlet authorized by Yamaha to sell the product, an authorized service center, or an authorized service representative of Yamaha.
3. This warranty is applicable only to units sold by retailers authorized by Yamaha to sell these products in the U.S.A., the District of Columbia, and Puerto Rico. This warranty is not applicable in other possessions or territories of the U.S.A. or in any other country.

Please record the model and serial number of the product you have purchased in the spaces provided below.

Model \_\_\_\_\_ Serial # \_\_\_\_\_ Sales Slip # \_\_\_\_\_

Purchased from \_\_\_\_\_ Date \_\_\_\_\_  
(Retailer)

**YAMAHA CORPORATION OF AMERICA**  
**Electronic Service Division**  
**6600 Orangethorpe Avenue**  
**Buena Park, CA 90620**

**KEEP THIS DOCUMENT FOR YOUR RECORDS. DO NOT MAIL!**

For details of products, please contact your nearest Yamaha representative or the authorized distributor listed below.

Pour plus de détails sur les produits, veuillez-vous adresser à Yamaha ou au distributeur le plus proche de vous figurant dans la liste suivante.

Die Einzelheiten zu Produkten sind bei Ihrer unten aufgeführten Niederlassung und bei Yamaha Vertragshändlern in den jeweiligen Bestimmungsländern erhältlich.

Para detalles sobre productos, contacte su tienda Yamaha más cercana o el distribuidor autorizado que se lista debajo.

## NORTH AMERICA

### CANADA

**Yamaha Canada Music Ltd.**  
135 Milner Avenue, Scarborough, Ontario,  
M1S 3R1, Canada  
Tel: 416-298-1311

### U.S.A.

**Yamaha Corporation of America**  
6600 Orangethorpe Ave., Buena Park, Calif. 90620,  
U.S.A.  
Tel: 714-522-9011

## CENTRAL & SOUTH AMERICA

### MEXICO

**Yamaha de Mexico S.A. De C.V.,  
Departamento de ventas**  
Javier Rojo Gomez No.1149, Col. Gpe Del  
Moral, Deleg. Iztapalapa, 09300 Mexico, D.F.  
Tel: 55-5804-0600

### BRAZIL

**Yamaha Musical do Brasil LTDA.**  
Av. Rebouças 2636, São Paulo, Brasil  
Tel: 011-3085-1377

### ARGENTINA

**Yamaha Music Latin America, S.A.  
Sucursal de Argentina**  
Viamonte 1145 Piso2-B 1053,  
Buenos Aires, Argentina  
Tel: 1-4371-7021

### PANAMA AND OTHER LATIN AMERICAN COUNTRIES/ CARIBBEAN COUNTRIES

**Yamaha Music Latin America, S.A.**  
Torre Banco General, Piso 7, Urbanización Marbella,  
Calle 47 y Aquilino de la Guardia,  
Ciudad de Panamá, Panamá  
Tel: +507-269-5311

## EUROPE

### THE UNITED KINGDOM

**Yamaha-Kemble Music (U.K.) Ltd.**  
Sherbourne Drive, Tilbrook, Milton Keynes,  
MK7 8BL, England  
Tel: 01908-366700

### IRELAND

**Danfay Ltd.**  
61D, Sallynoggin Road, Dun Laoghaire, Co. Dublin  
Tel: 01-2859177

### GERMANY

**Yamaha Music Central Europe GmbH**  
Siemensstraße 22-34, 25462 Rellingen, Germany  
Tel: 04101-3030

### SWITZERLAND/LIECHTENSTEIN

**Yamaha Music Central Europe GmbH,  
Branch Switzerland**  
Seefeldstrasse 94, 8008 Zürich, Switzerland  
Tel: 01-383 3990

### AUSTRIA

**Yamaha Music Central Europe GmbH,  
Branch Austria**  
Schleiergasse 20, A-1100 Wien, Austria  
Tel: 01-60203900

### THE NETHERLANDS

**Yamaha Music Central Europe,  
Branch Nederland**  
Clarissenhof 5-b, 4133 AB Vianen, The Netherlands  
Tel: 0347-358 040

## BELGIUM/LUXEMBOURG

**Yamaha Music Central Europe GmbH,  
Branch Belgium**  
Rue de Geneve (Genevastraat) 10, 1140 - Brussels,  
Belgium  
Tel: 02-726 6032

## FRANCE

**Yamaha Musique France**  
BP 70-77312 Marne-la-Vallée Cedex 2, France  
Tel: 01-64-61-4000

## ITALY

**Yamaha Musica Italia S.P.A.**  
Viale Italia 88, 20020 Lainate (Milano), Italy  
Tel: 02-935-771

## SPAIN/PORTUGAL

**Yamaha-Hazen Música, S.A.**  
Ctra. de la Coruna km. 17, 200, 28230  
Las Rozas (Madrid), Spain  
Tel: 91-639-8888

## GREECE

**Philippos Nakas S.A. The Music House**  
147 Skiathou Street, 112-55 Athens, Greece  
Tel: 01-228 2160

## SWEDEN

**Yamaha Scandinavia AB**  
J. A. Wettergrens Gata 1  
Box 30053  
S-400 43 Göteborg, Sweden  
Tel: 031 89 34 00

## DENMARK

**YS Copenhagen Liaison Office**  
Generatorvej 8B  
DK-2730 Herlev, Denmark  
Tel: 44 92 49 00

## FINLAND

**F-Musiikki Oy**  
Kluuvikatu 6, P.O. Box 260,  
SF-00101 Helsinki, Finland  
Tel: 09 618511

## NORWAY

**Norsk filial av Yamaha Scandinavia AB**  
Grini Næringspark 1  
N-1345 Østerås, Norway  
Tel: 67 16 77 70

## ICELAND

**Skifan HF**  
Skeifan 17 P.O. Box 8120  
IS-128 Reykjavik, Iceland  
Tel: 525 5000

## OTHER EUROPEAN COUNTRIES

**Yamaha Music Central Europe GmbH**  
Siemensstraße 22-34, 25462 Rellingen, Germany  
Tel: +49-4101-3030

## AFRICA

**Yamaha Corporation,  
Asia-Pacific Music Marketing Group**  
Nakazawa-cho 10-1, Hamamatsu, Japan 430-8650  
Tel: +81-53-460-2312

## MIDDLE EAST

### TURKEY/CYPRUS

**Yamaha Music Central Europe GmbH**  
Siemensstraße 22-34, 25462 Rellingen, Germany  
Tel: 04101-3030

### OTHER COUNTRIES

**Yamaha Music Gulf FZE**  
LB21-128 Jebel Ali Freezone  
P.O.Box 17328, Dubai, U.A.E.  
Tel: +971-4-881-5868

## ASIA

### THE PEOPLE'S REPUBLIC OF CHINA

**Yamaha Music & Electronics (China) Co.,Ltd.**  
25/F., United Plaza, 1468 Nanjing Road (West),  
Jingan, Shanghai, China  
Tel: 021-6247-2211

### HONG KONG

**Tom Lee Music Co., Ltd.**  
11/F., Silvercord Tower 1, 30 Canton Road,  
Tsimshatsui, Kowloon, Hong Kong  
Tel: 2737-7688

### INDONESIA

**PT. Yamaha Music Indonesia (Distributor)  
PT. Nusantik**  
Gedung Yamaha Music Center, Jalan Jend. Gatot  
Subroto Kav. 4, Jakarta 12930, Indonesia  
Tel: 21-520-2577

### KOREA

**Yamaha Music Korea Ltd.**  
Tong-Yang Securities Bldg. 16F 23-8 Yoido-dong,  
Youngdungpo-ku, Seoul, Korea  
Tel: 02-3770-0660

### MALAYSIA

**Yamaha Music Malaysia, Sdn., Bhd.**  
Lot 8, Jalan Perbandaran, 47301 Kelana Jaya,  
Petaling Jaya, Selangor, Malaysia  
Tel: 3-78030900

### PHILIPPINES

**Yupangco Music Corporation**  
339 Gil J. Puyat Avenue, P.O. Box 885 MCPO,  
Makati, Metro Manila, Philippines  
Tel: 819-7551

### SINGAPORE

**Yamaha Music Asia Pte., Ltd.**  
No.11 Ubi Road 1, No.06-02,  
Meiban Industrial Building, Singapore  
Tel: 747-4374

### TAIWAN

**Yamaha KHS Music Co., Ltd.**  
3F, #6, Sec.2, Nan Jing E. Rd. Taipei.  
Taiwan 104, R.O.C.  
Tel: 02-2511-8688

### THAILAND

**Siam Music Yamaha Co., Ltd.**  
891/1 Siam Motors Building, 15-16 floor  
Rama 1 road, Wangmai, Pathumwan  
Bangkok 10330, Thailand  
Tel: 02-215-2626

### OTHER ASIAN COUNTRIES

**Yamaha Corporation,  
Asia-Pacific Music Marketing Group**  
Nakazawa-cho 10-1, Hamamatsu, Japan 430-8650  
Tel: +81-53-460-2317

## OCEANIA

### AUSTRALIA

**Yamaha Music Australia Pty. Ltd.**  
Level 1, 99 Queensbridge Street, Southbank,  
Victoria 3006, Australia  
Tel: 3-9693-5111

### NEW ZEALAND

**Music Houses of N.Z. Ltd.**  
146/148 Captain Springs Road, Te Papapa,  
Auckland, New Zealand  
Tel: 9-634-0099

### COUNTRIES AND TRUST TERRITORIES IN PACIFIC OCEAN

**Yamaha Corporation,  
Asia-Pacific Music Marketing Group**  
Nakazawa-cho 10-1, Hamamatsu, Japan 430-8650  
Tel: +81-53-460-2312

**HEAD OFFICE** Yamaha Corporation, Pro Audio & Digital Musical Instrument Division  
Nakazawa-cho 10-1, Hamamatsu, Japan 430-8650  
Tel: +81-53-460-3273



Yamaha PK CLUB (Portable Keyboard Home Page, English only)

<http://www.yamahaPKclub.com/>

Yamaha Manual Library

<http://www2.yamaha.co.jp/manual/english/>

M.D.G., Pro Audio & Digital Musical Instrument Division, Yamaha Corporation  
© 2003 Yamaha Corporation

WA79720 ???PO???.?-02B0 Printed in China