



YAMAHA

Owner's Manual

AG-Stomp 
ACOUSTIC GUITAR
PRE-AMPLIFIER

1 LIMITER AREA CHANGE

2 CHORUS / DELAY ▼ DOWN .. BANK .. UP ▲

FCC INFORMATION (U.S.A.)

1. IMPORTANT NOTICE: DO NOT MODIFY THIS UNIT!

This product, when installed as indicated in the instructions contained in this manual, meets FCC requirements. Modifications not expressly approved by Yamaha may void your authority, granted by the FCC, to use the product.

2. IMPORTANT:

When connecting this product to accessories and/or another product use only high quality shielded cables. Cable/s supplied with this product MUST be used. Follow all installation instructions. Failure to follow instructions could void your FCC authorization to use this product in the USA.

3. NOTE:

This product has been tested and found to comply with the requirements listed in FCC Regulations, Part 15 for Class "B" digital devices. Compliance with these requirements provides a reasonable level of assurance that your use of this product in a residential environment will not result in harmful interference with other electronic devices. This equipment generates/uses radio frequencies and, if not installed and used according to the instructions found in the users manual, may cause interference harmful to the operation of other electronic devices. Compliance with FCC regulations does

not guarantee that interference will not occur in all installations. If this product is found to be the source of interference, which can be determined by turning the unit "OFF" and "ON", please try to eliminate the problem by using one of the following measures:

Relocate either this product or the device that is being affected by the interference.

Utilize power outlets that are on different branch (circuit breaker or fuse) circuits or install AC line filter/s.

In the case of radio or TV interference, relocate/reorient the antenna. If the antenna lead-in is 30 ohm ribbon lead, change the lead-in to coaxial type cable.

If these corrective measures do not produce satisfactory results, please contact the local retailer authorized to distribute this type of product. If you can not locate the appropriate retailer, please contact Yamaha Corporation of America, Electronic Service Division, 6600 Orangethorpe Ave, Buena Park, CA90620

The above statements apply ONLY to those products distributed by Yamaha Corporation of America or its subsidiaries.

* This applies only to products distributed by YAMAHA CORPORATION OF AMERICA.

CANADA

This Class B digital apparatus complies with Canadian ICES-003.

Cet appareil numérique de la classe B est conforme à la norme NMB-003 du Canada.

- This applies only to products distributed by Yamaha Canada Music Ltd.
- Ceci ne s'applique qu'aux produits distribués par Yamaha Canada Musique Ltée.



The exclamation point within the equilateral triangle is intended to alert the user to the presence of important operating and maintenance (servicing) instructions in the literature accompanying the product.



The lightning flash with arrowhead symbol, within the equilateral triangle, is intended to alert the user to the presence of uninsulated "dangerous voltage" within the product's enclosure that may be of sufficient magnitude to constitute a risk of electrical shock.

NEDERLAND / NETHERLAND

- Dit apparaat bevat een lithium batterij voor geheugen back-up.
- This apparatus contains a lithium battery for memory back-up.
- Raadpleeg uw leverancier over de verwijdering van de batterij op het moment dat u het apparaat ann het einde van de levensduur afdanke van de volgende Yamaha Service Afdeling:
Yamaha Music Nederland Service Afdeling
Kanaalweg 18-G, 3526 KL UTRECHT
Tel. 030-2828425
- For the removal of the battery at the moment of the disposal at the end of the service life please consult your retailer or Yamaha Service Center as follows:
Yamaha Music Nederland Service Center
Address : Kanaalweg 18-G, 3526 KL UTRECHT
Tel : 030-2828425
- Gooi de batterij niet weg, maar lever hem in als KCA.
- Do not throw away the battery. Instead, hand it in as small chemical waste.

IMPORTANT SAFETY INSTRUCTIONS

INFORMATION RELATING TO PERSONAL INJURY, ELECTRICAL SHOCK, AND FIRE HAZARD POSSIBILITIES HAS BEEN INCLUDED IN THIS LIST.

WARNING- When using any electrical or electronic product, basic precautions should always be followed. These precautions include, but are not limited to, the following:

1. Read all Safety Instructions, Installation Instructions, Special Message Section items, and any Assembly Instructions found in this manual BEFORE making any connections, including connection to the main supply.

2. Do not attempt to service this product beyond that described in the user-maintenance instructions. All other servicing should be referred to qualified service personnel.

3. Main Power Supply Verification: Yamaha products are manufactured specifically for the supply voltage in the area where they are to be sold. If you should move, or if any doubt exists about the supply voltage in your area, please contact your dealer for supply voltage verification and (if applicable) instructions. The required supply voltage is printed on the name plate. For name plate location, please refer to the graphic found in the Special Message Section of this manual.

4. WARNING: Do not place this product or any other objects on the power cord or place it in a position where anyone could walk on, trip over, or roll anything over power or connecting cords of any kind. The use of an extension cord is not recommended! If you must use an extension cord, the minimum wire size for a 25' cord (or less) is 18 AWG. NOTE: The smaller the AWG number, the larger the current handling capacity. For longer extension cords, consult a local electrician.

5. Ventilation: Electronic products, unless specifically designed for enclosed installations, should be placed in locations that do not interfere with proper ventilation. If instructions for enclosed installations are not provided, it must be assumed that unobstructed ventilation is required.

6. Temperature considerations: Electronic products should be installed in locations that do not seriously contribute to their operating temperature. Placement of this product close to heat sources such as; radiators, heat registers etc., should be avoided.

7. This product was NOT designed for use in wet/damp locations and should not be used near water or exposed to rain. Examples of wet /damp locations are; near a swimming pool, spa, tub, sink, or wet basement.

8. This product should be used only with the components supplied or; a cart, rack, or stand that is recommended by the manufacturer. If a cart, rack, or stand is used, please observe all safety markings and instructions that accompany the accessory product.

9. The power supply cord (plug) should be disconnected from the outlet when electronic products are to be left unused for extended periods of time. Cords should also be disconnected when there is a high probability of lightning and/or electrical storm activity.

10. Care should be taken that objects do not fall and liquids are not spilled into the enclosure through any openings that may exist.

11. Electrical/electronic products should be serviced by a qualified service person when:

- The power supply cord has been damaged; or
- Objects have fallen, been inserted, or liquids have been spilled into the enclosure through openings; or
- The product has been exposed to rain; or
- The product does not operate, exhibits a marked change in performance; or
- The product has been dropped, or the enclosure of the product has been damaged.

12. This product, either alone or in combination with an amplifier and headphones or speaker/s, may be capable of producing sound levels that could cause permanent hearing loss. DO NOT operate for a long period of time at a high volume level or at a level that is uncomfortable. If you experience any hearing loss or ringing in the ears, you should consult an audiologist.

IMPORTANT: The louder the sound, the shorter the time period before damage occurs.

13. Some Yamaha products may have benches and/or accessory mounting fixtures that are either supplied as a part of the product or as optional accessories. Some of these items are designed to be dealer assembled or installed. Please make sure that benches are stable and any optional fixtures (where applicable) are well secured BEFORE using. Benches supplied by Yamaha are designed for seating only. No other uses are recommended.

PLEASE KEEP THIS MANUAL



Owner's Manual

Thank you for purchasing the YAMAHA AG-Stomp Acoustic Guitar Pre-Amplifier.

Before you use the AG-Stomp, we urge you to take the time and read this Owner's Manual carefully in order to get the most out of the device's many functions and to obtain maximum life. Also, after reading the manual, please keep it in a safe place for future reference.

Contents

Precautions	5	External Control Settings	22
Nomenclature	6	Tuner Mode	23
■ Top Panel	6	■ Enter the Tuner Mode	23
■ Rear Panel	9	■ Tuning	23
Connections	10	■ Setting the Standard Pitch	23
■ Connecting the Power	10	Utility Mode	24
■ Connecting a Mixer or Amplifier	10	■ About the Utility Mode	24
■ Connecting Headphones	11	■ Footswitch Functions	24
■ Digital Output	11	■ MIDI Functions	24
■ Connecting an EXP Pedal	11	■ External Control Settings	26
■ Connecting MIDI Devices	11	■ EXP Pedal Settings	26
Using the AG-Stomp	12	■ Feedback Reduction Operating Mode	27
■ Connecting the Guitar	12	Error Messages	28
■ Produce Sound	13	Trouble Shooting	28
■ Editing Settings	13	Specifications	29
■ Selecting Patches	17	MIDI Implementation Chart	30
■ Storing Patches	19		
■ Other Convenient Functions	19		
Effect Functions and Parameters	21		

Precautions

- Avoid using the AG-Stomp in the following locations to prevent possible damage:
 - In direct sunlight or next to heating equipment.
 - In extremely cold or hot locations.
 - Locations exposed to high humidity or excessive dust.
 - Locations subject to strong shocks or vibration.
- Before making any connections, make sure that the power is switched OFF on the AG-Stomp and any external devices.
- To protect speakers from possible damage, always set the OUTPUT knob to "0" before switching the power ON/OFF.
- When connecting a speaker to this unit, make sure that the power is switched OFF first.
- Do not apply excessive force to the switches, knobs and controls.
- The AG-Stomp is a precision device. Handle it with care and avoid dropping or jarring it.
- For safety, always remove the power adaptor from the AC wall outlet if there is any danger of lightning striking in your area.
- Keep the AG-Stomp away from neon signs or fluorescent lighting to prevent noise pickup.
- To prevent damage and possibly electrical shock, never open the case and tamper with the internal circuitry.
- Never use benzene, thinner or other volatile liquids for cleaning, as these chemicals may cause damage or discoloration to the finish. Always use a dry, soft cloth to wipe off dust and dirt.

Nomenclature

■ Top Panel

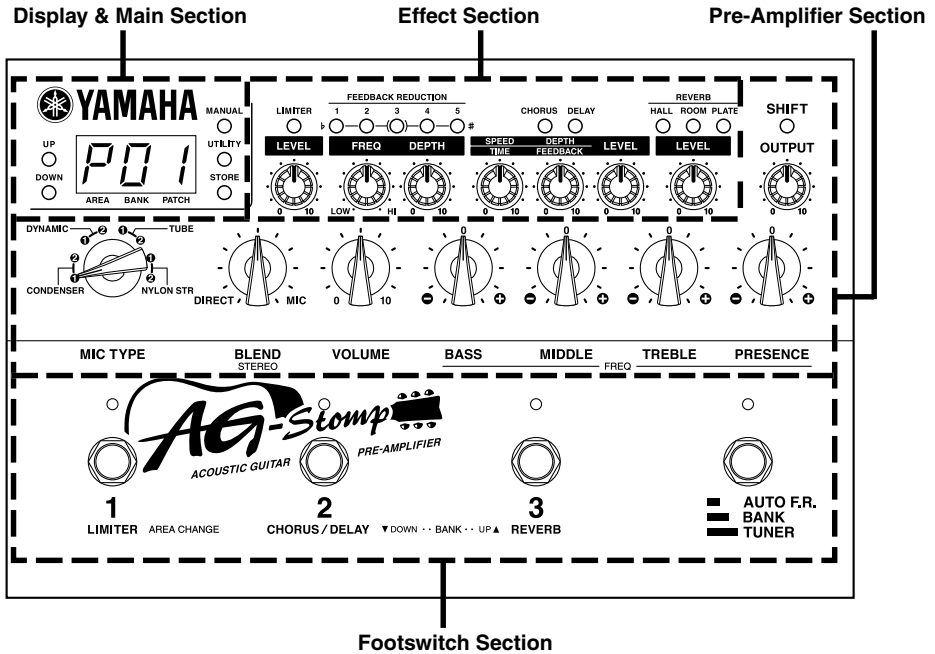

● Display & Main Section

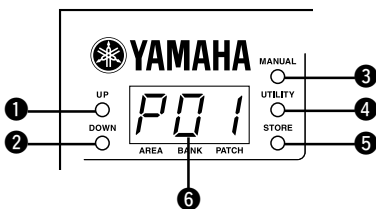

① UP Button

② DOWN Button

Press to change the Patch Number by +/-1. Hold the button to change the Bank Number by +/-1. Simultaneously press the [UP] and [DOWN] buttons to switch between the User ↔ Preset Areas.

Also, their flashing lamps are used to indicate the relationship between the knob's position and the patch's data value.

③ MANUAL Button

Independent of the selected patch's settings, this button changes the tone to that produced by the settings determined by the current position of each of the knobs.

The button's lamp will flash if the patch's setting is changed.

Press the [MANUAL] and [UTILITY] buttons simultaneously to enter the External Control Setting Mode. (→ page 22)

④ UTILITY Button

Enters the Utility Mode. (→ page 24)

Press the [UTILITY] and [STORE] buttons simultaneously to enter the Tuner Mode. (→ page 23)

⑤ STORE Button

Enters the Store Mode. (→ page 19)

⑥ Display

Displays patch numbers, values for parameter settings, etc.

● Pre-Amp Section

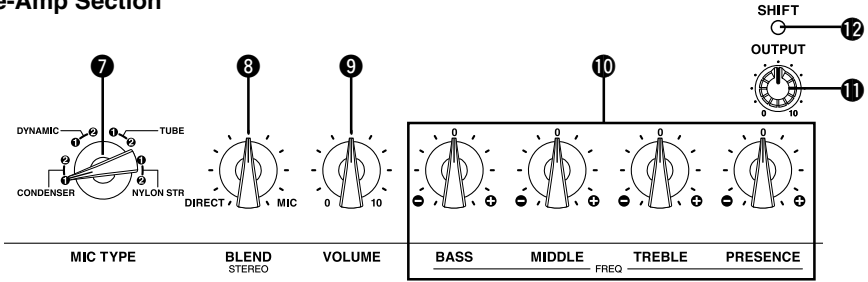

7 MIC TYPE Select Switch (MIC TYPE)

Selects a microphone simulator type.

In the Utility Mode, it is used to select functions you want to set such as Footswitch or MIDI Functions, etc.

8 BLEND Control (BLEND/STEREO)

Controls the volume balance between the guitar's direct sound and the sound produced by the mic simulator. (→ page 15)

When in the SHIFT mode, it is used to adjust the mic simulator's stereo setting. (→ page 15)

9 VOLUME

Controls the absolute sound volume of that set by the Tone Controls.

* The VOLUME knob's setting is saved in memory.

10 Tone Controls

(BASS, MIDDLE, TREBLE, PRESENCE)

Controls the level of the knob's related tone frequencies.

When in the SHIFT mode, they set the variable center frequency of the related Tone Control. (→ page 14)

11 OUTPUT Level Control

Controls the level of the signal delivered from the AG-Stomp's output jacks (OUTPUT, PHONES).

* The OUTPUT knob's setting is not saved in memory.

12 SHIFT Button

The button is used to enter the SHIFT mode in which the Mic Simulator's stereo setting and the Tone Control's variable center frequency settings can be made. (→ page 14 and 15)

● Effect Section (Refer to the [Effect Functions and Parameters] section on page 21)

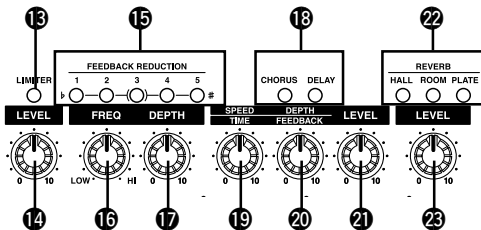

13 LIMITER Button

Switches the Limiter ON (lamp lit) or OFF (lamp off).

14 LEVEL

Adjusts the depth of the Limiter's effect.

Turn to the right to increase the depth of the effect.

* When set to "0", the Limiter will produce no effect.

Nomenclature

15 Feedback Reduction Buttons (FEEDBACK REDUCTION 1-5)

These switches are notch filters that are used to eliminate feedback. The five notch filters can be used to isolate and suppress those frequencies that are causing the feedback.

The notch filter's lamp will light when the corresponding band's filter is active. Up to five notch filters can be used simultaneously.

16 Frequency Control (FREQ)

Sets the frequency of the selected Feedback Reduction's Notch Filter. (→ page 16)

17 DEPTH Control

Sets the depth of the selected Feedback Reduction's Notch Filter. (→ page 16)

18 CHORUS/DELAY Effect Buttons

These buttons select the Chorus and Delay effects. The currently selected effect's lamp will light.

19 SPEED/TIME Control

Chorus effect: Sets the speed of the Chorus.
Delay effect: Sets the Delay time.

20 DEPTH/FEEDBACK Control

Chorus effect: Sets the depth of the Chorus effect.
Delay effect: Sets how long the delay will repeat.

21 LEVEL

Chorus effect: Sets the volume level of the Chorus effect.
Delay effect: Sets the volume level of the Delay effect.

22 Reverb Effect Buttons (HALL/ROOM/PLATE)

These buttons select the type of reverb effect to be used. The currently selected effect's lamp will light.

23 REVERB Volume

Sets the amount of Reverb that is added to the guitar's tone.

● Footswitch Section

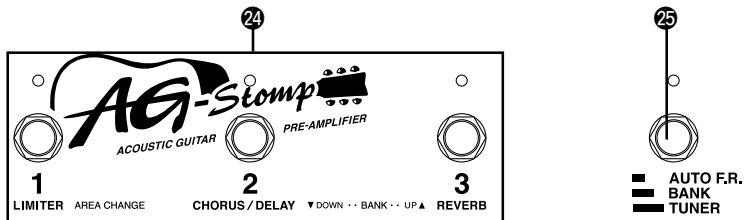

24 Footswitches 1, 2, 3

Depending upon the settings in the Utility Mode (→ page 24), these switches can operate in the following manner:

- Select a patch (1/2/3) from the currently selected Bank.
- Switch the Effect Blocks ON/OFF (1: Limiter, 2: Chorus/Delay, 3: Reverb)

25 Bank Switch (AUTO F.R./BANK/TUNER)

- **Press the switch when feedback occurs:** The AG-Stomp will automatically identify the problem frequency and apply a notch filter. (→ page 16)
- **Hold the switch until the display flashes:** Use Footswitch 1 to change the Area, Footswitch 2 or 3 to select the Bank. (→ page 18)
- **Hold the switch until “L” appears in the display:** Enters the Tuner Mode. (→ page 23)

■ Rear Panel

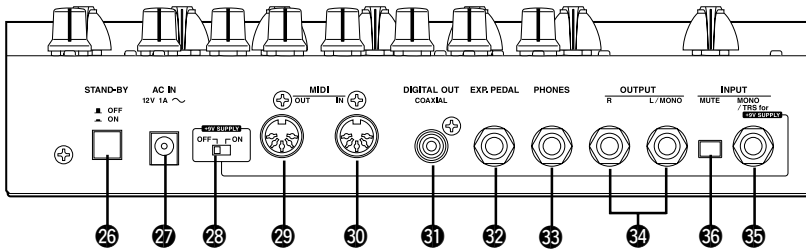

26 Power Switch (STAND-BY ON/OFF)

This is the unit's power switch.

* To protect the speakers, always set the OUTPUT knob 11 to "0" before switching the power ON/OFF.

27 Power Adaptor Jack (AC IN 12V 1A)

Connect the supplied power adaptor to this jack.

* Never use a power adaptor other than the supplied adaptor. Use of any other adaptor may result in damage, overheating, fire, etc.

28 Guitar Power Supply Switch (+9V SUPPLY ON/OFF)

This switch allows the delivery of power (DC9V) to an electric-acoustic guitar's built-in pre-amplifier through the AG-Stomp's INPUT jack via the supplied TRS phone cable. (→ page 12)

29 MIDI OUT Jack

This jack is used to transmit MIDI data from the AG-Stomp such as control changes, program changes, data in the AG-Stomp's memory, etc. (→ page 18)

30 MIDI IN Jack

This jack is used to receive MIDI data from an external MIDI device such as a MIDI Foot Controller, etc., which can be used select patches, control volume or control the AG-Stomp's individual effects. (→ page 18)

Also, AG-Stomp data saved in an external MIDI device can be returned to the AG-stomp via this jack. (→ page 25)

31 Digital Output Jack (DIGITAL OUT)

This jack is used to transmit the output of the AG-Stomp as digital data. Connect this jack to the digital input jack (COAXIAL) of a digital mixer, etc. (→ page 11)

32 EXP. PEDAL Jack

Connect a foot controller (expression pedal) (optional) such as the YAMAHA FC-7 to this jack and control individual parameter's of the AG-Stomp. (→ page 22, 26)

33 Headphone Jack (PHONES)

Connect a pair of headphones (optional) to this jack to monitor the AG-Stomp's sound when you want to practice privately. (→ page 11)

* Even when headphones are connected to this jack, the audio signal is delivered from the OUTPUT Jack 34 and the DIGITAL OUT Jack 31.

34 Output Jacks (OUTPUT R, L/MONO)

These are the AG-Stomp's analog output jacks (TRS balanced). Connect these jacks to the input jacks on a power amp and speaker system, guitar amplifier, mixer, etc.

A commercially available PA type TRS phone cable can be used to send a TRS balanced audio signal from the AG-Stomp. Also, the supplied TRS-XLR converter cables connected to these jacks deliver a balanced audio signal to the XLR jacks on a mixer, etc. (→ page 10)

* Use the L/MONO jack when connecting to a monaural device.

35 INPUT Jack

36 Input MUTE Switch

This is the AG-Stomp's input jack. Connect a guitar to this jack.

The supplied TRS phone cable can be used to deliver power to an electric-acoustic guitar's built-in pre-amplifier from the AG-Stomp. (→ page 12)

When pressed, the Input MUTE Switch (—) cuts the signal from the INPUT jack to prevent noise, etc. from entering the circuit. Use this switch when connecting or disconnecting the guitar's cable.

Connections

! Before making any connections to any of the AG-Stomp's INPUT and/or OUTPUT jacks, make sure that the power on the AG-Stomp and all other devices is turned OFF to prevent electrical shock or damage to the devices.

■ Connecting the Power

Use the supplied power adaptor (AC-10) to operate the AG-Stomp.

1. Make sure the AG-Stomp's Power Switch (STAND-BY) is in the OFF position (⬇️).
2. Connect the power adaptor's plug to the AC IN jack on the AG-Stomp.
3. Connect the power adaptor to an electric outlet.

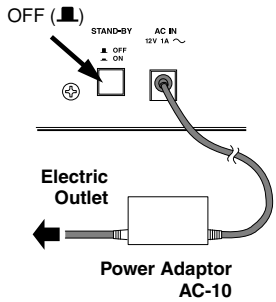

- !** Only use the supplied AC-10 power adaptor to power the unit. The use of any other power adaptor may cause damage, overheating or fire, which can be very dangerous.
- !** Make sure you use the proper AC voltage as indicated on the power adaptor.
- !** Never use the supplied power adaptor AC-10 with any other device.

** The AC adaptor's shape will vary according to the country to which the device is shipped.*

■ Connecting a Mixer or Amplifier

1. Use the supplied TRS-XLR converter cable to convert the AG-Stomp's outputs (balanced TRS) to balanced XLR outputs.
2. Use a commercially available PA type TRS phone cable, to connect the AG-Stomp's output jack to the balanced inputs of a mixer, power amplifier, etc.
3. When a monaural phone cable is used, connections will be unbalanced.

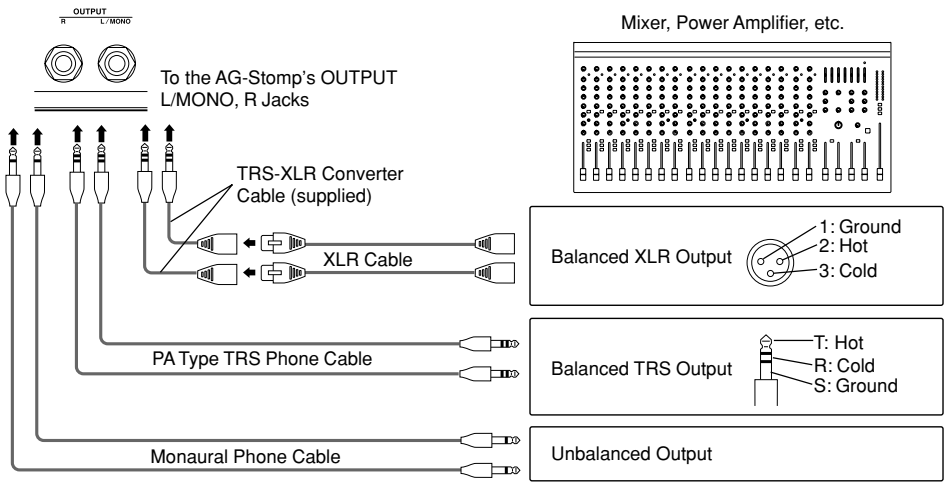

To realize the AG-Stomp's full potential, we recommend using it in stereo.

■ Connecting Headphones

Connect a pair of headphones to the AG-Stomp's PHONES jack (standard stereo) for monitoring the AG-Stomp while practicing privately. Use the OUTPUT knob to adjust the volume of the headphones.

** Even when headphones are connected to this jack, the audio signal is delivered from the OUTPUT Jack and DIGITAL OUT Jack.*

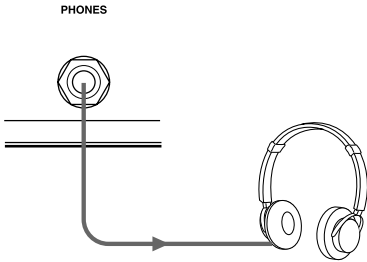

When using headphones, set the volume to a comfortable level so as not to harm to your hearing.

■ Digital Output

The AG-Stomp is equipped with a digital output jack (COAXIAL, 44.1 kHz) that provides direct digital connection to the digital input jack on a digital mixer, MD recorder, etc.

** The output level of the DIGITAL OUT jack cannot be controlled with the OUTPUT knob (the level is fixed).*

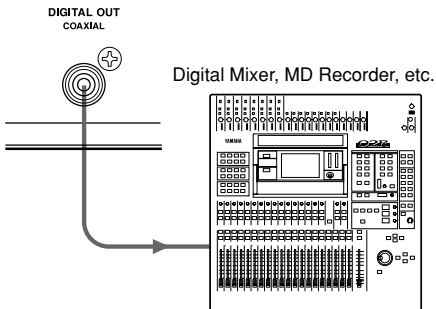

■ Connecting an EXP Pedal

A foot controller (expression pedal) (optional), such as the YAMAHA FC-7, etc., connected to the AG-Stomp's EXP. PEDAL jack allows control of individual parameters in the AG-Stomp. (→ page 22 and 26)

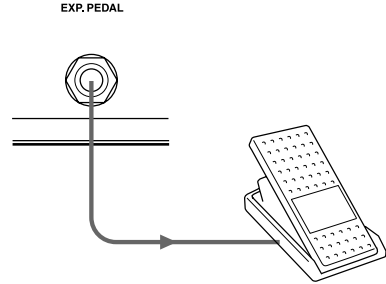

■ Connecting MIDI Devices

The MIDI IN/OUT jacks allow for the exchange of MIDI information between the AG-stomp and an external MIDI device.

This allows data from the AG-Stomp to be stored (using Bulk Dump) in a MIDI device such as the YAMAHA MIDI Data Filer MDF3, etc. also, data stored in an external MIDI device can be loaded into the AG-Stomp.

Also, a MIDI foot controller, etc., can be used to select AG-Stomp patches, control individual parameters, or set individual effects. External MIDI devices can also be controlled with the AG-Stomp. Refer to the "Utility Mode" (→ page 24) for more information on MIDI functions.

Using the AG-Stomp

First, connect your guitar to the AG-Stomp and try to get some sound.

■ Connecting the Guitar

Before making any connections, make sure the AG-Stomp's power is off, set the AG-Stomp's OUTPUT knob to "0" and the +9V SUPPLY switch to "OFF". Then connect the INPUT jack on the rear panel to the guitar's output jack with any commercially available guitar cable (monaural ↔ monaural).

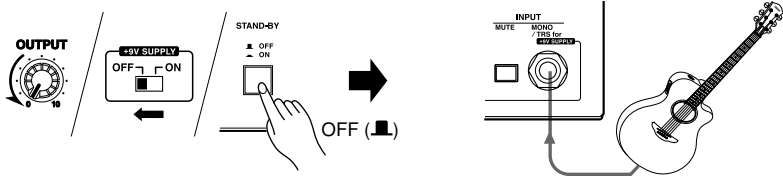

Never connect the guitar to the AG-Stomp with the supplied TRS phone cable when the Guitar Power Supply function described below is not used. If the TRS phone cable is used and the +9V SUPPLY switch is switched "ON", it may result in damage since a total of 18V will be supplied to the electric-acoustic guitar's built-in pre-amplifier. Also, if the +9V SUPPLY switch is set to "OFF", the electric-acoustic's built-in pre-amplifier may function abnormally.

● Guitar Power Supply

Before supplying power to your guitar, make sure that the guitar's pre-amplifier battery has been replaced with the dummy battery supplied with the AG-Stomp. Leaving the 006P 9V battery in place will result in the guitar's electronics receiving 18V of power, causing damage.

The AG-Stomp is capable of supplying power to your electric-acoustic guitar's built-in pre-amplifier via the supplied TRS phone cable. Power is supplied to the electric-acoustic guitar when the AG-Stomp's power is switched ON.

This function is possible as long as your electric-acoustic guitar meets the following conditions:

- The guitar uses a monaural output.
- The guitar uses a 006P 9V battery to supply power to the guitar's built-in pre-amplifier.
- The power to the guitar's built-in pre-amplifier is switched ON/OFF by connecting/disconnecting the cable at the guitar's jack.
- The guitar's built-in electronics consume 10mA of power, or less.

[Setting]

1. Replace the electric/acoustic guitar's built-in pre-amplifier battery with the dummy battery supplied with the AG-Stomp.
2. Before making any connections, turn off the AG-Stomp's power and make sure its OUTPUT knob is set to "0", then set the +9V SUPPLY switch to "ON".
3. Use the supplied TRS phone cable to connect the AG-Stomp's INPUT jack to the output jack on your electric/acoustic guitar.

** When the AG-Stomp's power is ON, make sure that the MUTE switch on the AG-Stomp is held down when connecting/disconnecting the cable.*

** Do not connect effectors, etc., between the AG-Stomp's INPUT jack and the electric-acoustic guitar's OUTPUT jack. Power will not be supplied to the electric-acoustic guitar's built-in pre-amplifier if the AG-Stomp and the electric-acoustic guitar are not directly connected.*

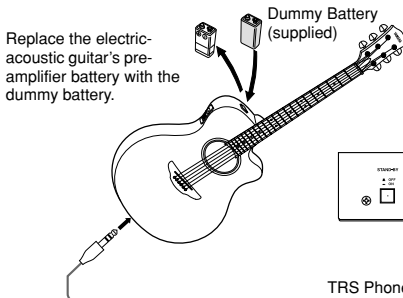

Set the +9V SUPPLY switch to the "ON" position.

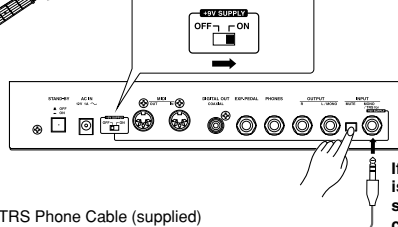

If the AG-Stomp's power is ON, hold the MUTE switch when making connections.

■ Produce Sound

1. After confirming that the OUTPUT knob is set to "0", press the Power Switch (STAND-BY) ON (▲).

! Switching the Power Switch ON when the OUTPUT knob is turned up may result in damage to devices such as the amplifier, speaker, headphones, etc., or cause unexpected accidents like damage to your hearing due to high volume settings.

2. "00 1" will appear in the display.



The characters (Memory Area: U (user), Bank Number: 0, Patch Number:1) indicate the currently selected patch.

When a patch number is shown in the display, this condition is known as the Play Mode. When in the Play Mode, patches can be selected and the knobs and buttons can be used to edit settings.

For now, try using this patch to produce some sound.

3. Play a chord on the guitar and rotate the OUTPUT knob to the right to adjust the volume.

* If clipping due to the input signal overloading the AG-Stomp's circuit occurs, the BANK Switch Lamp will light.

If this is the case, reduce the volume on the guitar, or adjust the AG-Stomp's VOLUME, individual TONE control knobs or individual Effect knobs. Also, if feedback occurs, please refer to the "Feedback Reduction" section on page 16.

■ Editing Settings

The panel knob and button functions can be used to create your own original tone.

● Changing Pre-amp Settings

Since the AG-Stomp's knob positions do not always represent the tone that is currently being produced, the knob must be "aligned" with the value set in memory before changes can be made to that value. For this reason, please follow the rules described below when rotating the knobs.

- If the [UP] lamp flashes when a knob is rotated, rotate the knob to the right (toward 10). If the [DOWN] lamp flashes, rotate the knob to the left (toward 0).

At this time, the patch's data value (the value set in the patch for the knob you are turning) will flash in the display.

* As long as the value is flashing in the display, the display and tone will not change even though the knob is being rotated.

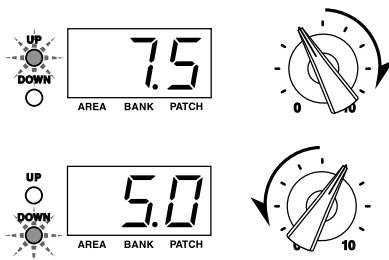

- Continue rotating the knob, when the knob reaches the position corresponding to the patch's data value, the display as well as the [UP]/[DOWN] lamps will stop flashing. After this, the tone will change according to the knob's position.

* After you stop moving the knob, the value will be displayed for approximately two more seconds, then return to the normal display.

* Even if only one value is changed, the [MANUAL] lamp will flash to indicate that data in the patch has been changed.

Also, when all settings (except for the OUTPUT knob) are changed, the [MANUAL] lamp will light.

- Once the knob is in an editable condition (in which the patch data's value can be changed), rotating the knob will result in the value shown in the display changing in regards to the knob's position causing a relative change in tone.

Using the AG-Stomp

The previously described rules apply to all knobs except the OUTPUT knob.

The MIC TYPE SELECT switch also functions in the same manner. When the knob is rotated, the Mic Simulator type that is set in the patch data will flash in the display. After rotating the knob to the position of the Mic Simulator type indicated in the display, select the Mic Simulator type you want to use.

The OUTPUT knob and VOLUME knob

Either knob can be used to change the volume however, the VOLUME knob setting is stored in the patch data while the OUTPUT knob's setting is not. Use the VOLUME knob to set the volume of each patch and use the OUTPUT knob to control the AG-stomp's output volume.

● Changing Effect Settings

Try switching each of the Effect Blocks ON/OFF or try changing the effect. Also, try rotating knobs for each of the effects to change the character of the effect.

The AG-Stomp's effects section is divided into the following three blocks.

- Limiter (LIMITER)
 - Chorus/Delay (CHORUS/DELAY)
 - Reverb (HALL/ROOM/PLATE)
- Press the button of the effect you want to use to select it (the lamp will light).
- In the Chorus/Delay and Reverb blocks, only one effect per block can be used at a time. Also, pressing a button that is lit will result in the light going off and the effect in that block being deactivated.

All knobs can be used to set or edit parameters of the block's selected effect.

* Refer to the "Effect Functions and Parameters" section on page 21 for more information on the function and knob settings for individual effects.

* The operation of each of the effect's knobs follows the same rules as described in the pre-amp section.

● Set the Tone Control's Center Frequency

The BASS, MIDDLE, TREBLE and PRESENCE tone controls each have a variable center frequency.

[Procedure]

1. Press the [SHIFT] button so that its lamp flashes (enter the SHIFT mode).
2. To adjust the Center Frequency, rotate the Tone Control of the related frequency range you want to set. Turn the knob to the left (counter-clockwise) to lower the center frequency, or turn the knob to the right (clockwise) to raise the center frequency.

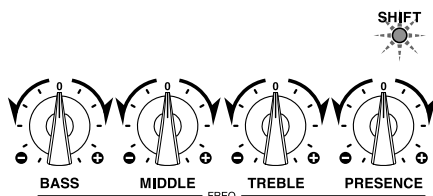

Variable Range

- BASS 50Hz - 400Hz
- MIDDLE 200Hz - 1.6kHz
- TREBLE 600Hz - 4.8kHz
- PRESENCE 2.0kHz - 16kHz

3. Press the [SHIFT] button so that its lamp turns off (exit the SHIFT mode).

* If no editing is performed after 5 seconds of entering the SHIFT mode, the mode will automatically be exited.

* A list of note names corresponding to each of the acoustic guitar's frets and their standard frequencies is provided in the supplemental "Patch List".

Please use the list when setting the Tone Control's Variable Center Frequency.

Tone Control Center Frequency settings are stored in Patch Data.

● Setting the Mic Simulator

The Mic Simulator is a specially designed circuit that adds to an electric/acoustic guitar, the special characteristics created when miking an acoustic guitar. It adds the airiness, which is found when a microphone is placed in front of the guitar's sound hole. The Mic Simulator is useful when your guitar is connected directly to a mixer or recorder via a line, or when listened to through a pair of headphones for practice, etc.

The AG-Stomp provides the eight different Mic Simulator settings described below. The Mic Simulator creates a stereo image by simulating two microphones positioned in front of the guitar but "aimed" at different angles toward the guitar. Use the MIC TYPE Select Switch to try out some of the different microphone simulation types.

The BLEND knob is used to adjust the volume balance between the signal after it has passed through the Mic Simulator (MIC tone) and the signal before it has passed through the Mic Simulator (DIRECT tone). Rotate the knob fully to the left to hear only the DIRECT tone. Rotate the knob fully to the right to hear only the MIC tone.

Also, pressing the [SHIFT] button to enter the SHIFT mode (the SHIFT lamp flashes) lets you use the BLEND (stereo) knob to adjust spaciousness of the sound produced by the Mic Simulator's two microphones. Press the [SHIFT] button again to exit the SHIFT mode and the lamp will turn off.

** In the SHIFT mode, if a knob is not rotated after five seconds, the mode will be exited automatically.*

Simulates microphones positioned close to the guitar.

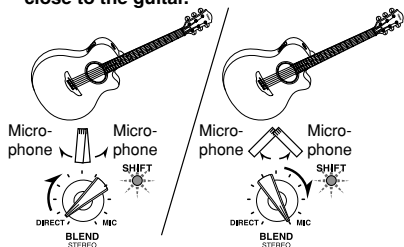

Simulates microphones positioned far from the guitar.

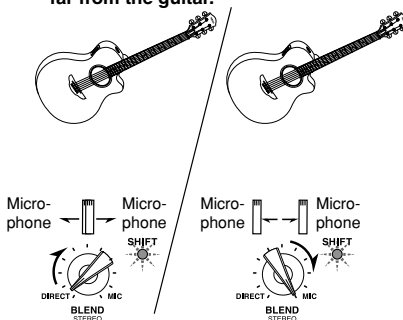

MIC TYPE Select Switch Position	Display	Description of the Simulation
CONDENSER 1	$\zeta - 1$	Simulates the characteristics associated with a condenser mic positioned close to the acoustic guitar.
CONDENSER 2	$\zeta - 2$	Simulates the characteristics associated with a condenser mic positioned far from the acoustic guitar. Room sound is also present.
DYNAMIC 1	$d - 1$	Simulates the characteristics associated with a dynamic mic positioned close to the acoustic guitar.
DYNAMIC 2	$d - 2$	Simulates the characteristics associated with a dynamic mic positioned far from the acoustic guitar. Room sound is also present.
TUBE 1	$t - 1$	Simulates the characteristics associated with a tube mic positioned close to the acoustic guitar.
TUBE 2	$t - 2$	Simulates the characteristics associated with a tube mic positioned far from the acoustic guitar. Room sound is also present.
NYLON STR 1	$n - 1$	Simulates the characteristics associated with a nylon string guitar with a condenser mic positioned close to the guitar.
NYLON STR 2	$n - 2$	Simulates the characteristics associated with a nylon string guitar with a condenser mic positioned far from the guitar. Room sound is also present.

** Mic Simulator settings are stored in patch data (MIC TYPE Select Switch Settings).*

** When the Volume and Tone controls are set to high, the signal may clip inside of the AG-Stomp. In this case, decrease the guitar's volume, or adjust the AG-Stomp's VOLUME, individual Tone Controls or individual Effect knobs. Also, if feedback occurs, please use the Feedback Reduction Function described on page 16.*

Using the AG-Stomp

● Feedback Reduction

The AG-Stomp is equipped with a Feedback Reduction Function to prevent feedback.

Feedback is caused when a certain frequency or frequencies of the amplified sound causes the guitar to resonate thereby being re-amplified until a steady howl or whistle is heard.

The AG-Stomp prevents feedback from occurring by means of a notch filter, which is used to cut the problem frequency. The AG-Stomp provides a total of five notch filters (1-5) that can be applied and operate simultaneously.

[Procedure]

The AG-Stomp provides two ways to set Feedback Reduction.

• AUTO Setting

When feedback occurs, press the BANK switch. The AG-Stomp will automatically identify the problem frequency and apply an available notch filter.

* The DEPTH is set to its maximum value (knob 10: -20dB) in the AUTO setting.

* When feedback occurs with chords, etc., the AUTO setting might not provide adequate performance. In this case, use the MANUAL setting as described in the next section.

• MANUAL Setting

Press one of the [FEEDBACK REDUCTION] buttons 1-5 (its lamp will flash). Use the FREQ knob to select the frequency that needs to be cut, then use the DEPTH knob to adjust the amount of reduction needed.

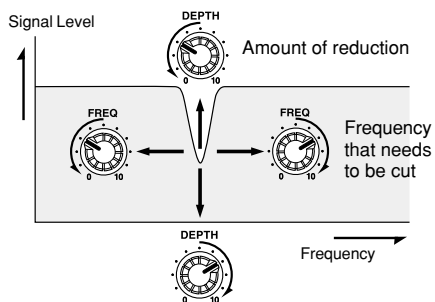

After adjustments have been made, press the same button to set the setting (the lamp will light and the filter will be active).

To deactivate (lamp OFF) an active filter (lamp ON), press and hold the button of the filter you want to deactivate until "OFF" appears in the display.

* Refer to the "EFFECT FUNCTIONS and PARAMETERS" section (page 21) for more information on settings for each of the Feedback Reduction's knobs.

If feedback is continuously occurring at a high volume level, it may cause damage to equipment. Please use caution.

Depending upon Utility Mode settings, Feedback Reduction settings are either included with patch data (P r L) or, kept separate of patch data so that the same Feedback Reduction settings/parameters will remain active (L L b) even though a different patch is selected. (→ page 27)

Also, if the "L L b" (global) setting is used in the Utility Mode, Feedback Reduction settings will be stored as global data when patch data is stored so, the settings will be erased if the power is turned off before the settings are stored.

When another patch is selected, any settings that were changed will be returned to their original condition. If you want to keep the changes you made to those settings, use the Store Operation described on page 19.

■ Selecting Patches

The AG-Stomp holds a total of 60 patch programs (patch) in its internal memory. The 60 patches are divided into two areas, ten banks and three patches.

• AREA

There are two areas, the **USER AREA** and the **PRESET AREA**. Data in the USER AREA (30 patches) can be freely rewritten using the STORE operation. Data in the PRESET AREA (30 patches) can be edited but the contents can not be rewritten to PRESET AREA memory.

When a USER AREA patch is selected, a “U” will appear in the display’s hundred’s digit (U0 1-U9 3).

When a PRESET AREA patch is selected, a “P” will appear in the display’s hundred’s digit (P0 1-P9 3).

** When the AG-Stomp is shipped, both the PRESET AREA and USER AREA contain the same patch data. (Refer to the supplemental [Patch List]).*

• BANK

The 30 patches in each area are divided into ten banks (0-9).

• PATCH

Each Bank contains three patches (1-3).

Try selecting some of the different patches and try out some of the sounds.

To select a different patch, use one of the three methods described below.

● Use the [UP]/[DOWN] buttons on the panel.

- Each time the [UP] button is pressed, the next greater **patch number** is selected.

U0 1 → U0 2 → U0 3 → U 1 1 → U 1 2 →
U 1 3 U 9 1 → U 9 2 → U 9 3 → P0 1 →
P0 2 P9 3 → U0 1 (returns to the top)...

Each time the [DOWN] button is pressed, the next lesser **patch number** is selected.

- Holding the [UP] button continuously increases the **bank number** by one.

U0 1 → U 1 1 → U 2 1 → U 3 1 U 9 1 →
P0 1 → P 1 1 P 9 1 → U0 1 (returns to the top)...

Holding the [DOWN] button continuously decreases the **bank number** by one.

- Simultaneously press the [UP] and [DOWN] button switches between the **USER AREA** and **PRESET AREA**.

U0 1 ↔ P0 1

• Patch Characteristics

USER AREA (U0 1~U9 3)				
BANK 0	BANK 1	BANK 2	BANK 3	BANK 4
PATCH 1	PATCH 1	PATCH 1	PATCH 1	PATCH 1
PATCH 2	PATCH 2	PATCH 2	PATCH 2	PATCH 2
PATCH 3	PATCH 3	PATCH 3	PATCH 3	PATCH 3
BANK 5	BANK 6	BANK 7	BANK 8	BANK 9
PATCH 1	PATCH 1	PATCH 1	PATCH 1	PATCH 1
PATCH 2	PATCH 2	PATCH 2	PATCH 2	PATCH 2
PATCH 3	PATCH 3	PATCH 3	PATCH 3	PATCH 3

PRESET AREA (P0 1~P9 3)				
BANK 0	BANK 1	BANK 2	BANK 3	BANK 4
PATCH 1	PATCH 1	PATCH 1	PATCH 1	PATCH 1
PATCH 2	PATCH 2	PATCH 2	PATCH 2	PATCH 2
PATCH 3	PATCH 3	PATCH 3	PATCH 3	PATCH 3
BANK 5	BANK 6	BANK 7	BANK 8	BANK 9
PATCH 1	PATCH 1	PATCH 1	PATCH 1	PATCH 1
PATCH 2	PATCH 2	PATCH 2	PATCH 2	PATCH 2
PATCH 3	PATCH 3	PATCH 3	PATCH 3	PATCH 3

Using the AG-Stomp

● Using the Footswitches and Bank Switch

- Press a Footswitch (1-3) to select the corresponding **patch number 1-3** in the currently selected bank.

** If the Footswitch's function is set to "EFF" in the Utility Mode, it will not be possible to directly select a patch with the Footswitch. (→ page 24)*

- Press and hold the BANK switch until the display and the footswitch lamp flashes (**Bank Select Mode**), then remove your foot from the switch. In this condition, the following procedure can be used.

** Even when the Footswitch function is set to "EFF" in the Utility Mode, stepping on the BANK switch will enter this mode.*

1. Press Footswitch 1 to switch between the **USER AREA (U)** ↔ **PRESET AREA (P)**. Changing to another area will cause the Footswitch's lamps to flash.
2. Each time Footswitch 2 is pressed, the **Bank Number** will decrease by 1.
3. Each time Footswitch 3 is pressed, the **Bank Number** will increase by 1.
4. **[If the Footswitch Function is set to "P-U"]** Press the BANK switch to return to the Play Mode. The patch number that was selected before performing step 1 of this procedure will be selected.
[If the Footswitch Function is set to "EFF"] Press the BANK switch and the patch number in the display will flash. Footswitches 1-3 can be used to select their corresponding patches (1-3). Press the BANK switch to return to the PLAY Mode with the Area/Bank/Patch you just selected ready.

** To cancel the Area/Bank/Patch you just selected, press the BANK switch. The AG-Stomp will return to its previous condition.*

● Using a MIDI Controller

Patches in the AG-Stomp can also be selected by transmitting MIDI Program Change data from an external MIDI device such as the YAMAHA MIDI Foot Controller MFC10, etc.

1. Connect the MIDI IN jack on the AG-Stomp to the MIDI OUT jack on an external MIDI device with a MIDI cable.

** Make sure a standard MIDI cable is used. Also, the length of the MIDI cable should be limited to 15 meters. The use of a longer cable may result in trouble such as inferior performance of the device, etc.*

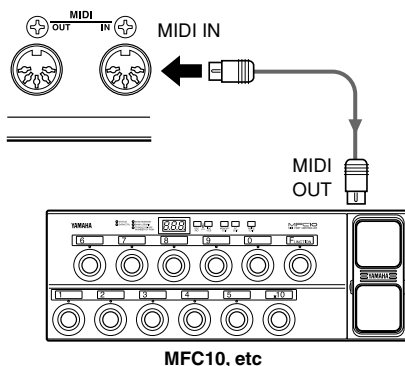

2. Match the AG-Stomp's MIDI receive channel, with the MIDI transmit channel on the external MIDI device.

→ **page 25 [Set the MIDI Receive Channel]**

3. Create a Program Change Table*.

→ **page 24 [Create a Program Change Table]**

** This operation assigns patch numbers to corresponding program change numbers that are received from an external device. For example, when the program change number "1" is received, the AG-Stomp's patch number "U13" is recalled.*

** The default for Program Change Number: Patch Number is
1: U01, 2: U02, ... 60: P93, 61: U01, ... 120: P93, ...128: U22.*

4. When program change data is transmitted from an external MIDI device and received by the AG-Stomp, the corresponding patch in the Program Change Table you created will be selected.

** Refer to the Owner's Manual of your external MIDI device, etc., for information on how to transmit program change data.*

■ Storing Patches

After editing or creating an original patch, your settings can be stored in the USER AREA (U01-U93). Try creating an original patch and store it.

● Storing Procedure

1. Press the [STORE] button.
When the Store Mode is entered, the display, the STORE lamp and the Footswitch lamp that corresponds to the patch number will flash.
2. Select the patch (Bank and Patch Number) to which you want to store the patch.
Use the same procedure as described in “Selecting Patches” (page 17) to select the patch number. You can also use the [UP]/[DOWN] buttons, Footswitches and BANK Switches to select the patch number. However, you cannot change the AREA (data can only be written to the USER AREA).
3. After selecting the patch number you want to store your data in, hold the [STORE] button.
The store operation is complete when all the lamps light.

* Utility mode settings are not stored in individual patches, they are stored in the AG-Stomp's memory as common settings for all parameters.

* The OUTPUT knob's setting is not stored in memory. Use the Volume knob to set differences in volume for situations like backing, soloing, etc.

* Data in the USER AREA (U01-U93) can be stored in an external MIDI device. (→ page 25)

* During the Store Operation, MIDI data can not be received.

The STORE operation is used not only to store your original patches, but it can also be used to rearrange your patches in an order suitable for use during live performance.

■ Other Convenient Functions

Here are some other convenient functions that you can use with the AG-Stomp.

● Use Footswitches 1-3 to Switch the Effects ON/OFF

Footswitch 1 can be used to act as an ON/OFF switch for the Limiter, Footswitch 2 as an ON/OFF switch for the Chorus/Delay Effect and Footswitch 3 as an ON/OFF switch for the Reverb Effect.

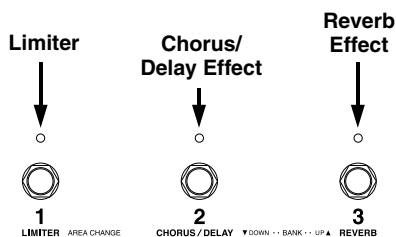

1. Press the [UTILITY] button and set the MIC TYPE Select Switch to CONDENSER 1.
After entering the Utility Mode, “F.S” will appear in the display followed by the currently selected Footswitch Function.
 - P r U : Select a patch
 - E F F : Switch the effect block ON/OFF
2. Use the [UP]/[DOWN] buttons to set the Footswitch Function to “E F F”.
3. Press the [UTILITY] button to return to the Play Mode.
4. Now, pressing Footswitches 1-3 will switch the corresponding effect ON/OFF.

* To select a different Bank or Area, press and hold the BANK switch until the display and the Footswitch Lamp flashes. (→ page 18)

Using the AG-Stomp

● Using the AG-Stomp Without Patches

The [MANUAL] button gives you direct control of the AG-Stomp's parameters and effects when patches are not used.

Press the [MANUAL] button to enter the Manual Mode (the lamp will light). In this mode, the tone produced by the AG-Stomp is determined by the current position of all knobs and effect buttons (with the exception of the [FEEDBACK REDUCTION] buttons), changes to any knob or button will have a direct effect on the tone.

To exit the Manual Mode, simply recall any patch. Press a Footswitch (1-3) that corresponds to the patch number shown in the display to return the AG-Stomp to the same condition previous to entering the Manual Mode.

Also, the MANUAL Mode will be exited if the [SHIFT] button is pressed to enter the SHIFT mode for editing one of the secondary parameters. At this time the [MANUAL] button's lamp will flash.

● Using a Foot Pedal (Controller)

A foot controller (expression pedal) (optional) such as the YAMAHA FC-7, etc. connected to the EXP. PEDAL jacks can be used to control of the AG-Stomp's volume, tone or effect parameters (setting values).

→ page 22 [External Control Settings]

● Control the AG-Stomp From an External MIDI Device

An external MIDI device's MIDI OUT jack, connected to the AG-Stomp's MIDI IN jack via a MIDI cable can be used to control the AG-Stomp's volume, tone or effect parameters (setting values).

→ page 22 [External Control Settings]

● Chromatic Auto Tuner Function

To enter the Tuner Mode, press the [UTILITY] and [STORE] buttons simultaneously, or hold the BANK switch until "♯ ♭" appears in the display when in the Play Mode. The Tuner Mode supplies you with a chromatic auto tuner for tuning.

→ page 23 [Tuner Mode]

● Factory Default

To return the AG-Stomp's settings to their factory default condition, simultaneously hold the [UP] and [MANUAL] buttons and turn the Power ON (■), all data in the USER AREA will be rewritten with data for the patches listed in the "Patch List" which can be found on a supplemental sheet.

When the AG-Stomp is reset to its factory default condition, all patch data you stored will be erased. We recommend that any important data be stored in an external MIDI device or that notes be taken of the settings.

Effect Functions and Parameters

Limiter

● LIMITER

The Limiter prevents the input signal from exceeding a preset level (peak).

• LEVEL Knob

Rotate the knob to the right to increase the amount of the Limiter's effect.

When set to "0.0", the Limiter will have no effect.

Feedback Reduction

The AG-Stomp provides a total of five Notch Filter circuits that can be used to control specified frequencies.

Applied to frequencies that are the source of feedback, these Notch Filters are used to prevent feedback from occurring.

Press a band button (the lamp lights) and set the parameter to operate the filter function.

A total of five Notch Filters can be applied at the same time.

• FREQ Knob

Sets the frequency to be cut.

• DEPTH Knob

Sets how much the signal will be reduced.

** Refer to the Filter Graph found on page 16.*

Chorus/Delay Effects

The AG-Stomp is equipped with Chorus and Delay effects.

** Both the Chorus and Delay effects can not be used simultaneously. Use only one at a time.*

● Chorus

This effect adds depth and width to the original tone by modulating the pitch.

• SPEED Knob

Sets the speed at which the pitch will modulate.

• DEPTH Knob

Sets the depth at which the pitch will modulate.

• LEVEL Knob

Sets the amount of Chorus effect that is mixed with the original tone.

● Delay

This digital delay effect repeats the original sound after a determined pause.

• TIME Knob

Sets the delay time (the time separating the original sound and the repeated delay sound).

• FEEDBACK Knob

Sets number of times the delayed sound will repeat.

** Too high a setting may result in an uncontrolled oscillation of sound. Please use caution.*

• LEVEL Knob

Sets the amount of Delay effect that is mixed with the original tone.

Reverb Effect

The AG-Stomp is equipped with three types of digital reverb, HALL, ROOM and PLATE.

● HALL (Hall Reverb)

This reverb effect simulates the reverb produced in a concert hall.

• REVERB Knob

Controls the volume of the source signal into the Reverb circuit.

● ROOM (Room Reverb)

This reverb effect simulates the natural reverb produced in a room.

• REVERB Knob

Controls the volume of the source signal into the Reverb circuit.

● PLATE (Plate Reverb)

This reverb effect simulates the reverb produced by a metal plate.

• REVERB Knob

Controls the volume of the source signal into the Reverb circuit.

** If the same Reverb Type is switched from a patch using a REVERB level other than "0" to a patch using a REVERB level of "0", the remaining reverb will be leftover. Of course, the sound of the new patch will not be affected by the previous Reverb.*

External Control Settings

A foot controller (expression pedal) (optional), such as the YAMAHA FC-7, connected to the AG-Stomp's EXP. PEDAL jack lets you control the volume and tone of the AG-Stomp and effect parameters (setting values). These same parameters can also be controlled with MIDI control changes.

* In the following section, the abbreviation [FR 1] button refers to the [FEEDBACK REDUCTION 1] button, etc.

■ Procedure

1. In the Play Mode, press the [MANUAL] and [UTILITY] buttons simultaneously.

"**CTL**" will appear in the display when the External Control Setting Mode is entered.

2. Press the [LIMITER] button.

A control number will appear in the display.

Use the [UP]/[DOWN] buttons to set a control number.

Up to 8 external control settings (control numbers: 1-8) can be stored in the AG-Stomp's memory. Eight individual controllers can be used to control individual parameters or a single controller can be used to control 8 parameters.

3. Press the [FR 1] button.

The controller type will appear in the display.

Use the [UP]/[DOWN] buttons to set the type of controller.

- **EXP** : The foot controller connected to the AG-Stomp's EXP. PEDAL jack is the controller.

- **1-31, 54-95** : Control change data received from an external MIDI device connected to the AG-Stomp's MIDI IN jack does the controlling. Select the appropriate control change number. (Refer to the Owner's Manual for the external MIDI device for information on MIDI control change numbers.)

4. Press the [FR 2] button

The parameter type will appear in the display.

Use the [UP]/[DOWN] buttons to set the type of parameter you want controlled.

- **OFF** : off (no control)
- **BAL** : Balance between the DIRECT tone and the MIC tone (BLEND)
- **STER** : The stereo position of the two mics (STEREO)

- **PRE** : Post pre-amp volume
- **REV** : Post reverb volume
- **BAS** : Tone Control (BASS)
- **MID** : Tone Control (MIDDLE)
- **TRE** : Tone Control (TREBLE)
- **PRE** : Tone Control (PRESENCE)
- **LEV** : Limiter Level
- **SPT** : SPEED/TIME settings for the Chorus/Delay Effects
- **DEP** : DEPTH/FEEDBACK settings for the Chorus/Delay Effects
- **LEV** : LEVEL setting for the Chorus/Delay Effects
- **REV** : REVERB setting for the Reverb Effect

The controller that is set in step 3 of this procedure can control the above parameters (setting values).

5. Press the [FR 3] button

The minimum parameter value (the controller's minimum parameter value) will appear in the display.

Use the [UP]/[DOWN] buttons to set the value (0.0-10.0).

6. Press the [FR 4] button

The maximum parameter value (the controller's maximum parameter value) will appear in the display.

Use the [UP]/[DOWN] buttons to set the value (0.0-10.0).

7. Press the [UTILITY] button to return to the Play Mode.

These external control settings are stored with patch data.

Also, in the Utility Mode, there is a function that is not related to patch data settings that sets the Utility Mode's External Control to always ON (effective) or always OFF. (→ page 26)

Tuner Mode

This mode is used for tuning your guitar. In the Tuner Mode, the AG-Stomp operates like a chromatic auto tuner.

■ Enter the Tuner Mode

To enter the Tuner Mode, use any one of the three methods described below.

- In the Play Mode, press the [UTILITY] and [STORE] buttons simultaneously.
- In the Play Mode, hold the BANK switch until “E U” appears in the display. (The Tuner Mode comes after the Bank Select Mode.)
- In the Bank Select Mode, hold the BANK switch until “E U” appears in the display.



In the Tuner Mode, all outputs on the AG-Stomp (OUTPUT, PHONES, DIGITAL OUT) will be muted (no sound will be produced).

■ Tuning

The name of the note closest to that of which you played will appear in the display, and the five lamps will be used to indicate whether the note's pitch is high or low.

1. Use the [UP]/[DOWN] buttons to change the standard pitch. (Refer to the following “Setting the Standard Pitch” section.)
2. Play the note you want tune (play only a single note).
 - At first, roughly tune the guitar so that the name of the note you want to tune appears in the display. Note names are indicated in the display as follows:

A	B \flat	C	D \flat	D	E \flat	E	F	G \flat	G	A \flat
A	B \flat	C	D \flat	D	E \flat	E	F	G \flat	G	A \flat

- If the pitch is low, the FEEDBACK REDUCTION 1 and 2 lamps will light while the FEEDBACK REDUCTION 3 lamp flashes. If the pitch is high, the FEEDBACK REDUCTION 4 and 5 lamps will light while the FEEDBACK REDUCTION 3 lamp flashes.

Finely tune the note until only the FEEDBACK REDUCTION 3 lamp lights, then tuning is complete. (At this time the BANKS Switch's lamp will also light.)

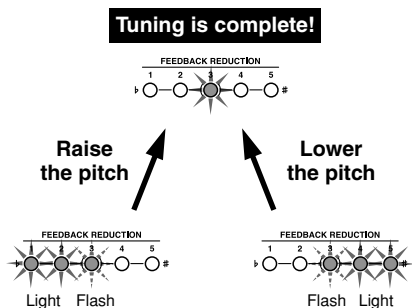

3. Press the [UTILITY] button or the BANK Switch to return to the Play Mode.

■ Setting the Standard Pitch

Usually the tuner's standard pitch is set to A=440Hz, however there are some cases where the standard pitch of an acoustic piano, etc. is set to a pitch other than 440Hz.

The AG-Stomp's standard pitch can be set to a pitch anywhere between 436Hz and 444Hz.

1. In the Tuner Mode, press the [UP] or [DOWN] button to display the standard pitch in the display.

* When the AG-Stomp's power is switched ON, the standard pitch is automatically set to 440Hz.

2. Every time the [UP] button is pressed, the standard pitch will increase by 1Hz, and every time the [DOWN] button is pressed, the standard pitch will decrease by 1Hz.

Utility Mode

The Utility Mode is used for the AG-Stomp's overall system settings for things such as the footswitch, MIDI, external controllers, EXP. PEDAL jack, etc.

* In the following section, the abbreviation [FR 1] button refers to the [FEEDBACK REDUCTION 1] button, etc.

■ About the Utility Mode

When in the Play Mode, press the [UTILITY] button to enter the Utility Mode (the lamp lights).

When in the Utility Mode, press the [UTILITY] button to return to the Play Mode (the lamp turns off).

In the Utility Mode, MIDI messages cannot be received. Use the Play Mode to receive MIDI messages.

Also, individual Utility Mode settings are saved when the Utility Mode is exited.

In the Utility Mode, it is possible to set the following five functions. Use the MIC TYPE Select Switch to select the function.

1: Footswitch Functions

2: MIDI Functions

3: External Control Settings

4: EXP Pedal Settings

5: Feedback Reduction Operating Mode

■ Footswitch Functions

Press the [UTILITY] button and set the MIC TYPE Select Switch to CONDENSER 1 ("F.S" will appear in the display).

● Select the Footswitch function.

Press the [LIMITER] button and use the [UP]/[DOWN] buttons to set the function of Footswitches (1-3).

- $P - \bar{D}$: Use the Footswitches to select patches.
- EFF : Use the Footswitches to switch the effects ON/OFF.
Switch 1: Limiter
Switch 2: Chorus/Delay Effects
Switch 3: Reverb Effect

● Transmit Control Change Numbers

Sets the MIDI control change number that is transmitted when the Footswitch is switched ON/OFF. (Available only when the Footswitch Function is set to "EFF".)

Press the [FR 1] button to display the value of the currently selected setting in the display.

Press the Footswitch you want to set (the lamp lights), and use the [UP]/[DOWN] buttons to set to one of the following.

- $0FF$: MIDI data is not transmitted.
- $1-32, 64-95$: The Control Change Number that is transmitted.

● Control Change Values transmitted when the switch is OFF.

Sets the MIDI control change value that is transmitted when the Footswitch is switched OFF. (Available only when the Footswitch Function is set to "EFF".)

Press the [FR 2] button to display the value of the currently selected setting in the display.

Press the Footswitch you want to set (the lamp lights), and use the [UP]/[DOWN] buttons to set.

- $\bar{D} - 127$: The Control Change Value that is transmitted.

● Control Change Values transmitted when the switch is ON.

Sets the MIDI control change value that is transmitted when the Footswitch is switched ON. (Available only when the Footswitch Function is set to "EFF".)

Press the [FR 3] button to display the value of the currently selected setting in the display.

Press the Footswitch you want to set (the lamp lights), and use the [UP]/[DOWN] buttons to set.

- $\bar{D} - 127$: The Control Change Value that is transmitted.

■ MIDI Functions

Press the [UTILITY] button and set the MIC TYPE Select Switch to CONDENSER 2 ("MIDI" will appear in the display).

● Create a MIDI Program Change Receive Table

Sets the corresponding patch that will be recalled when a MIDI Program Change Number (referred to as PRG No. from here on) is received.

Press the [LIMITER] button to set the receiving MIDI PRG No. Use the [UP]/[DOWN] buttons to select the number.

- *1-128* : MIDI Program Change No.

Press the [FR 1] button to set the AG-Stomp's patch number. Just as in selecting a patch number in the Play Mode, use the [UP]/[DOWN] buttons or the Footswitches to select.

- *UD 1-093, PD 1-093* :

The patch number that is recalled.

● Create a MIDI Program Change Transmit Table

When a Footswitch (1-3) is pressed to recall a patch, a MIDI Program Change Number can be transmitted from the AG-Stomp's MIDI OUT jack to control an external effector, etc., from the AG-Stomp. This table assigns to the patch, a MIDI PRG No. that will be transmitted when the patch is recalled.

Press the [FR 2] button to set the AG-Stomp's patch number. Just as in selecting a patch number in the Play Mode, use the [UP]/[DOWN] buttons or the Footswitches to select.

- *UD 1-093, PD 1-093* :

The patch number that is recalled.

Press the [FR 3] button to set the PRG. No. that will be transmitted. Use the [UP]/[DOWN] buttons to set.

- *1-128* : MIDI Program Change No.

● Set the MIDI Receive Channel

Sets the AG-Stomp's MIDI Receive Channel. The MIDI channel set in this step is also used as the device number for the bulk receive function.

Press the [FR 4] button and use the [UP]/[DOWN] buttons to set the MIDI receive channel.

- *OFF* : MIDI messages are not received
- *ALL* : MIDI messages from all channels are received
- *1-16* : MIDI channel over which messages are received.

● Set the MIDI Transmit Channel

Sets the AG-Stomp's MIDI Transmit Channel. The MIDI channel set in this step is also used as the device number for the bulk out function.

Press the [FR 5] button and use the [UP]/[DOWN] buttons to set the MIDI transmit channel.

- *1-16* : MIDI channel over which messages are transmitted.

● ON/OFF setting for MIDI Merge

Sets whether or not the MIDI signal that is received via the AG-Stomp's MIDI IN jack will also be transmitted via the MIDI OUT jack.

Press the [CHORUS] button and use the [UP]/[DOWN] buttons to set the merge setting.

- *ON* : Data is retransmitted via the MIDI OUT jack.
- *OFF* : Data is not retransmitted via the MIDI OUT jack.

** When the merge function is set to on, data retransmitted via the MIDI OUT jack is not confined to the channel set in the MIDI Receive Channel setting so all data from all channels will be transmitted.*

● MIDI Bulk Out

This operation transmits data stored in the AG-Stomp's USER AREA as well as Utility Mode settings to an external device, such as the YAMAHA MDF3, etc., which can be used to store MIDI data for back up.

Use a MIDI cable to connect the AG-Stomp's MIDI OUT jack to the MIDI IN jack of an external MIDI device.

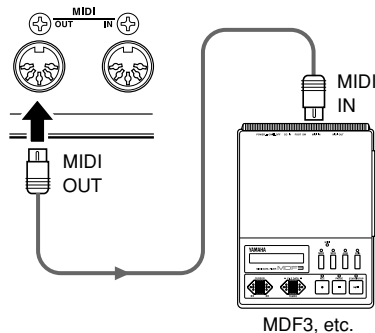

To send all USER AREA data (*UD 1-093*) and Utility Settings with the Bulk Out Operation

Press the [DELAY] button ("*ALL*" will appear in the display), then press the [STORE] button to carry out the MIDI Bulk Out operation.

To send a single USER AREA patch (data) with the Bulk Out operation

After pressing the [HALL] button, select the patch number to Bulk Out. Just as in selecting a patch number in the Play Mode, use the [UP]/[DOWN] buttons or the Footswitches to select the patch. After selecting the patch, press the [STORE] button to

Utility Mode

carry out the MIDI Bulk Out operation with a single patch.

* After transmitting the data, the device will return to its previous condition, ready to select another patch number.

● About the MIDI Bulk In Operation

This operation is used to return data stored in an external MIDI device, such as the YAMAHA MDF3, etc., to the AG-Stomp.

Use a MIDI cable to connect the MIDI OUT jack on the external MIDI device to the AG-Stomp's MIDI IN jack.

When the Bulk Out is carried out from the external MIDI device, the AG-Stomp will receive the bulk data.

* Use the AG-Stomp's Play Mode to receive MIDI Bulk In data.

When the MIDI Bulk In operation is carried out, the contents of the patches in the USER AREA will be rewritten.

Please make sure any important data is saved before carrying out the MIDI Bulk In operation.

■ External Control Settings

Just as in the "External Control Settings" section on page 22, these settings are used to control the AG-Stomp's volume, tone and effect parameters from a foot controller that is connected to the EXP. PEDAL jack or from a MIDI device that is connected to the MIDI IN jack.

Press the [UTILITY] button and set the MIC TYPE Select Switch to DYNAMIC 1 ("E L") will appear in the display).

● External Control's Operating Mode Setting

Press the [LIMITER] button and use the [UP]/[DOWN] buttons to set the External Control's Operating Mode.

- $\bar{L} b$: The external control setting in the Utility Mode is always available.
- $P \bar{L}$: The external control setting that is set in the patch is available.
- FF : External control is always OFF.

The following five settings are only available when the Operating Mode above is set to " $\bar{L} b$ ".

● Set the External Control Number

Press the [FR 1] button and use the [UP]/[DOWN] buttons to set a control number (1-8).

* Refer to the "External Control Settings" section (page 22).

● Set the External Controller

Press the [FR 2] button and use the [UP]/[DOWN] buttons to set the controller type (EP, 1-3 1, 5 4-55).

* Refer to the "External Control Settings" section (page 22).

● Set the Parameter to be Controlled

Press the [FR 3] button and use the [UP]/[DOWN] buttons to set the parameter to be controlled (bRL-).

* Refer to the "External Control Settings" section (page 22).

● Set the Parameter's Minimum Value

Press the [FR 4] button and use the [UP]/[DOWN] buttons to set the parameter's minimum value (the parameter's value when the controller is set to its minimum: 00-100).

* Refer to the "External Control Settings" section (page 22).

● Set the Parameter's Maximum Value

Press the [FR 5] button and use the [UP]/[DOWN] buttons to set the parameter's maximum value (the parameter's value when the controller is set to its maximum: 00-100).

* Refer to the "[External Control Settings" section (page 22).

■ EXP. Pedal Settings

These settings are available when the EXP. Pedal "EP" is selected as the controller in the External Control Settings.

Press the [UTILITY] button and set the MIC TYPE Select switch DYNAMIC 2 ("EP" will appear in the display).

● Set the Minimum Value of the EXP. Pedal

Sets the minimum value that indicates the position of the EXP. Pedal.

Press the [LIMITER] button and use the [UP]/[DOWN] buttons to set the position (0-128).

You can also hold the [LIMITER] button and move the EXP. Pedal to set the position.

* Due to the relationship between the maximum and minimum value, a value which results in a practical range (refer to the illustration below) of less than 128 can not be used.

● Set the Maximum Value of the EXP. Pedal

Sets the maximum value that indicates the position of the EXP. Pedal.

Press the [FR 1] button and use the [UP]/[DOWN] buttons to set the position (127-255).

You can also hold the [FR 1] button and move the EXP. Pedal to set the position.

* Due to the relationship between the maximum and minimum value, a value which results in a practical range of less than 128 can not be used.

* The value can not be set greater than that of the EXP. Pedal's Switch Setting.

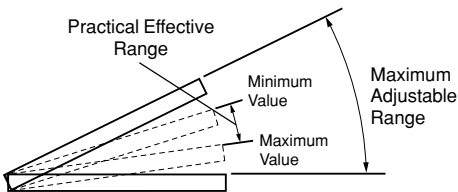

● Transmitting Control Change Numbers from the EXP. Pedal

Sets the MIDI control change number that is to be transmitted when the EXP. pedal is used.

Press the [FR 2] button and use the [UP]/[DOWN] buttons to set the control change number.

- 0FF : MIDI is not transmitted
- 132, 64-95 :

The control change number that is to be transmitted.

■ Feedback Reduction Operating Mode

Press the [UTILITY] button and set the MIC TYPE Select Switch to TUBE 1. After "F.r" appears in the display, the current setting is displayed.

Use the [UP]/[DOWN] buttons to set the Feedback Reduction Operating Mode.

- $\overline{UL}b$: Even if the patch is changed, the same Feedback Reduction parameters and settings will remain active (the same as the current condition).
- $\overline{Pr}\overline{U}$: When patches are changed, the Feedback Reduction's parameters and settings will be changed to those that are stored with the patch's data.

Error Messages

If an error occurs during operation, one of the following error message numbers will appear in the display.

Stop operation of the AG-Stomp and follow one of the solutions described below.

E 1: MIDI Receive Buffer Full

CAUSE: Too much MIDI data is being received and the buffer is full

SOLUTION: Try reducing the amount of data being sent, or break the data into smaller blocks.

E 2: Communication Error

CAUSE: An abnormality is detected during MIDI communications.

SOLUTION: Check all connections, etc. and try again.

E 3: Bulk Receive Check Sum Error

CAUSE: The check sum does not match the received MIDI bulk dump data.

SOLUTION: Check all connections and transmitted data, and try again.

E 4: Bulk Receive Data Abnormality

CAUSE: An abnormality is detected while receiving the bulk dump.

SOLUTION: Check all connections and transmitted data, and try again.

Trouble Shooting

No Sound

- Is the power adaptor properly connected?
- Is the volume level on the guitar amplifier turned up?
- Is the VOLUME knob set to "0"?
- Is the OUTPUT knob set to "0"?
- If an EXP pedal is being used to control the volume, try stepping on the pedal.
- Is the Tuner Mode active? Press the [UTILITY] button or press the BANK switch to return to the Play Mode.
- **If power is being supplied to the electric-acoustic guitar from the AG-Stomp.**
 - Is the +9V SUPPLY switch set to "ON"? (→ page 12).
 - Is the electric-acoustic guitar's pre-amplifier battery replaced with the dummy battery? (→ page 12).

Rotating the Knobs Does Not Change the Sound

- Turn the knob until the value in the display changes, then adjust the setting. (→ page 13)
- Is that knob's effect switched ON? After selecting the effect, by pressing the effect button, turn the knob to adjust the setting. (→ page 14)

Can Not Transmit MIDI

- Is the MIDI channel matched with the MIDI channel of the receiving device? (→ page 25)
- Is the MIDI Merge set to "OFF"? (→ page 25)

Can Not Receive MIDI

- Is the AG-Stomp in the Play Mode? Return to the Play Mode and try receiving again.
- Is the AG-Stomp's MIDI receive channel set to the same MIDI channel used by the transmitting device? (→ page 25)

Specifications

Digital Section

- Full Digital Signal Processing
- Mic Simulator: 8 Types
- Feedback Reduction: 5-band
- Digital Effects
 - Limiter
 - Digital Chorus, Digital Delay
 - Hall Reverb, Room Reverb, Plate Reverb
- External Controller Function (EXP Pedal/MIDI): 8 Controllers/Parameters
- Tuner Function (Chromatic, Auto)

MIDI Functions

Receive: Program Change (Program Change Table can be created), Control Change, Bulk In

Transmit: Program Change, Control Change, Bulk Out, Merge Out

Guitar Power Supply

9V power can be supplied via a TRS phone cable to a guitar's built-in pre-amplifier, etc. that consumes less than 10mA of power, and uses a mono-aural output.

Controller/Switch

Top Panel

Push Switch x17

UP, DOWN, MANUAL, UTILITY, STORE, LIMITER, FEEDBACK REDUCTION 1-5, CHORUS, DELAY, HALL, ROOM, PLATE, SHIFT

Knob x15

MIC TYPE, BLEND, VOLUME, BASS, MIDDLE, TREBLE, PRESENCE, LIMITER LEVEL, FEEDBACK REDUCTION FREQ, FEEDBACK REDUCTION DEPTH, CHORUS SPEED/DELAY TIME, CHORUS DEPTH/DELAY FEEDBACK, CHORUS LEVEL/DELAY LEVEL, REVERB LEVEL, OUTPUT

Footswitch x4

1, 2, 3, BANK

Rear Panel

STAND-BY ON/OFF, MUTE, +9V SUPPLY ON/OFF

Display

7 Segment LED (3 digit) x1

Push Switch LED x17

Footswitch LED x4

Connections

INPUT: Standard Stereo Phone Jack

OUTPUT L/MONO, R: Standard Stereo Phone Jack (TRS Balanced)

PHONES: Standard Stereo Phone Jack

EXP. PEDAL: Standard Stereo Phone Jack

DIGITAL OUT: COAXIAL

MIDI IN, MIDI OUT: 5-pin DIN

A/D Converter

20 bit

D/A Converter

20 bit

Sampling Frequency

44.1kHz

Memory Allocations

Preset: 30

User: 30

Input Level/Impedance

(When using pre-amp bypass)

INPUT: -17 dBm / 1 M Ω

Output Level/Impedance

OUTPUT L/MONO: Balance +4 dBm / 600 Ω

OUTPUT R: Balance +4 dBm / 600 Ω

PHONES: 0 dBm / 47 Ω

Power

Exclusive Power Adaptor (AC-10)

AC Output: AC 12 V, 1 A

Power Consumption

15 W

Dimensions

280(W)x70(H)x184(D)mm (11.0"x2.8"x7.2")

Weight

2.2 kg (4lbs. 4oz.)

Accessories

Power Adaptor (AC-10)

TRS Phone Cable for Guitar Power Supply (3m)

TRS-XLR Converter Cable (x2)

Dummy Battery

Owner's Manual (this booklet)

* Specifications and design may change without notice.

MIDI Implementation Chart

YAMAHA [Acoustic Guitar Pre Amplifier] Date:1-May-2001
 Model AG stomp MIDI Implementation Chart Version : 1.0

Function ...	Transmitted	Recognized	Remarks
Basic Default	1 - 16	1 - 16, off	memorized
Channel Changed	1 - 16	1 - 16, off	
Default	1,3	1,3	memorized
Mode Messages	x	x	
Altered	*****	x	
Note	x	x	
Number : True voice	*****	x	
Velocity Note ON	x	x	
Note OFF	x	x	
After Key's	x	x	
Touch Ch's	x	x	
Pitch Bender	x	x	
0	x	x	
1 - 31	o	o	
32 - 63	x	x	
64 - 95	o	o	
Control 95 -127	x	x	
Change			

MIDI Implementation Chart

Prog	: 0 0 - 127	: 0 0 - 127	
Change : True #	: *****	: *****	
System Exclusive	: 0	: 0	Bulk Dump
System : Song Pos.	: x	: x	
: Song Sel.	: x	: x	
:common : Tune	: x	: x	
System :Clock	: x	: x	
Real Time :Commands	: x	: x	
Aux :All Sound OFF	: x	: x	
:Reset All Cntrls	: x	: x	
:Local ON/OFF	: x	: x	
:All Notes OFF	: x	: x	
Mes- :Active Sense	: 0	: x	
sages:Reset	: x	: x	
Mode 1	: OMNI ON, POLY	: Mode 2 : OMNI ON, MONO	: 0 : Yes
Mode 3	: OMNI OFF, POLY	: Mode 4 : OMNI OFF, MONO	: x : No

