



# R Remote Version 3 User's Guide

---

Thank you for choosing a Yamaha product.

This user's guide explains setup and use of "R Remote," a Windows/Mac application that lets you make parameter settings for the Rio3224-D/Rio1608-D/Ri8-D/Ro8-D/RSio64-D/RMio64-D (subsequently "R series") units.

This application lets you edit the parameters of up to twenty four R series units from a single computer. Even if the R series unit is not connected, you can mount it virtually and edit its settings beforehand.

Up to two computers in which R Remote is installed can be connected to a single device. This means, for example, that the main operator could operate a console such as the CL while two assistants make detailed adjustments at the other locations.



## ■ NOTICE

- Yamaha Corporation owns exclusive copyrights for the R Remote, and the user's guide.
- It is prohibited to duplicate or modify the firmware, software or manuals, in part or in their entirety, without permission from the copyright owner.
- The screen displays as illustrated in this User Guide are for instructional purposes, and may appear somewhat different from the screens which appear on your computer.
- This software was not produced with the intention to support touch-panel operation in Windows 8 / Windows 8.1, so we cannot guarantee operation if a touch-panel is used.
- Dante is a trademark of Audinate.
- Windows is a registered trademark of Microsoft ® Corporation in the United States and other countries.
- Mac and Macintosh are trademarks of Apple Inc., registered in the U.S. and other countries.
- The company names and product names in this document are the trademarks or registered trademarks of their respective companies.
- This guide predominantly uses screenshots of Windows. However, Mac screenshots are used when instructions of the function apply only to the Mac.
- Software may be revised and updated without prior notice.

## Contents

■ Using the PDF manual.....	4
■ System Requirements .....	4
Operation .....	4
■ Setup.....	5
Install the R Remote .....	5
Set on the R series units .....	6
For Rio3224-D / Rio1608-D / Ri8-D .....	6
For RSio64-D.....	7
For RMio64-D.....	8
Connect the computer and R series units.....	9
Power-on the R series units .....	9
Specify the computer's IP address.....	10
For Windows.....	10
For Mac.....	12
Use Dante Controller or the CL/QL series console to specify the routing .....	12
■ Operating R Remote.....	13
Menu bar .....	13
Areas of the screen .....	14
Device Selection Area .....	15
Information Display Area .....	15
Main Area.....	16
For Rio3224-D / Rio1608-D / Ri8-D .....	16
For Ro8-D .....	20
For RSio64-D.....	21
For RMio64-D.....	25
“Network Setup” dialog box.....	27
“Device Information” dialog box .....	28
“IP Address” dialog box.....	29
“Properties” dialog box .....	30
■ Uninstalling the software(Removing the application).....	31
■ Troubleshooting .....	32
Decimal/hexadecimal conversion table .....	34

## ■ Using the PDF manual

- You can move to the corresponding page by clicking on links in the table of contents or in the text.
- If you want to find information on a specific topic, function or feature, select “Find” or “Search” from the Adobe Reader “Edit” menu and enter a key word to locate the related information anywhere in the document.
- You can also click on desired items and topics you want to refer to in the “Bookmarks” index to the left of the main display window, and jump to the corresponding page. (Click the “Bookmarks” tab to open the index if it is not displayed.)

## ■ System Requirements

In order to use R Remote, you'll need the following items.

- A computer equipped with the following conditions:

OS	Windows 7 SP1 Home Premium or later, Windows 8, Windows 8.1 (R Remote supports both 32-bit and 64-bit Windows.) Mac OS X 10.9.5, 10.10.x
CPU	Intel Core i3/i5 or higher
HDD	120MB or more
Connector	An Ethernet connector (1000BASE-T or higher recommended)
Others	Dante Controller must be installed. (*)

(\*)You can download Dante Controller from the download page of the following website.

<http://www.yamahaproaudio.com/>

- Ethernet cable (CAT5e or better)
- Network switch (with gigabit Ethernet support)
- R series units ( up to twenty four units) with firmware V3.00 or later

### Operation

#### Keyboard Shortcuts

<Windows modifier key> ( <Mac modifier key>) + <key> or click shows the shortcut keys. For example, <Ctrl> (<command>) +click means “press <Ctrl> under Windows or <command> under Mac, then click.”

#### Right Click

On Mac click while holding down the <control> key.

## ■ Setup

The setup workflow is shown below.

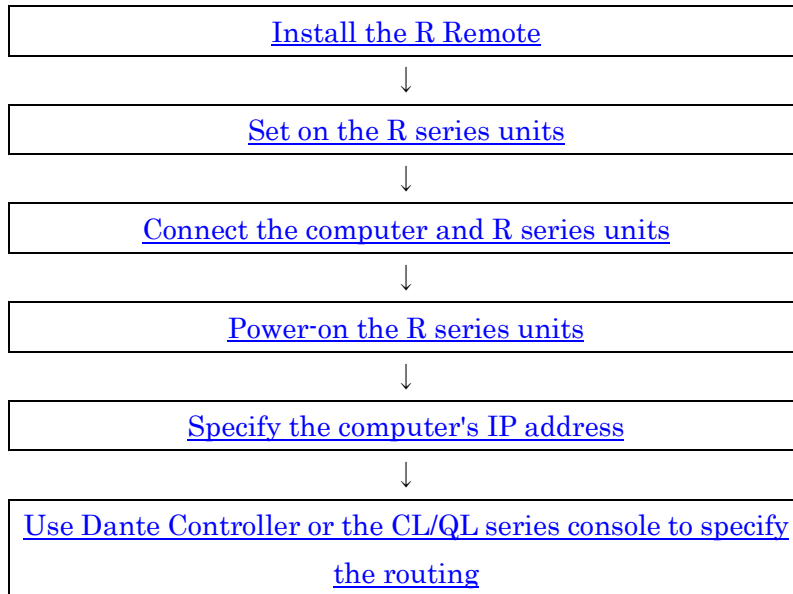

For details on connections and settings for the R series units, refer also to the owner's manual of your R series units.

### Install the R Remote

The installation procedure is as follows.

1. Logon to Windows or Login to Mac with administrator account.
2. After decompressing the downloaded file, double-click “setup.exe”(Windows) or “Install R Remote Vxxx.pkg”(Mac)(xxx is version) in the decompressed file location.

The R Remote setup wizard will appear.

**NOTE**

- Under Windows, the “User Account Control” dialog box may appear. Click [Continue] or [Yes].





3. Proceed with the installation as directed by the instructions in the screen.

## Set on the R series units

For Rio3224-D / Rio1608-D / Ri8-D

When using R Remote to operate a Rio3224-D / Rio1608-D / Ri8-D unit, set the DIP switches and [UNIT ID] rotary switch of the unit, taking note of the following settings.









- Set the UNIT ID in the range of 1 to 24 (hexadecimal 18). R Remote will not detect units with a setting of 0 or 25 or higher. (For details on converting between decimal and hexadecimal, refer to ["Decimal/hexadecimal conversion table."](#))
- Set the DIP switches to the following combinations. Put DIP switches 5 and 6 in the upward position.
  - UNIT ID

Settings	Switch
UNIT ID ranging from 0 to F	  (1 up)
UNIT ID ranging from 10 to 1F	  (1 down)

- IP address

Specify the IP address that R Remote uses for control. This is the setting for control; it is different than the IP address of the Dante network, so it will be different than the IP address specified on the Dante Controller.



The first time that you connect an R series unit to your computer after purchasing it, set this to something other than STATIC IP (MANUAL). If you want to use the STATIC IP (MANUAL) setting, first specify the IP address from R Remote and then switch to STATIC IP (MANUAL).

Settings	Switch
AUTO IP (The Dante network automatically sets the IP address to 169.254.xx.xx)	  (2 and 3 up)
DHCP (The IP address assigned by the DHCP server will be used.)	  (2 down, 3 up)
STATIC IP(AUTO) (The IP address will be set to 192.168.0.xx (xx= UNIT ID).)	  (2 up, 3 down)
STATIC IP(MANUAL) (Set the IP address to the value specified by R Remote)	  (2 and 3 down)



**NOTE**

If the network consists only of Dante devices and R Remote, we recommend that you use the AUTO IP setting. If you are connecting to an existing network, select DHCP as needed. If you want to use zoning to set the IP address, or want to connect to an existing network but use a static IP address, choose STATIC IP (MANUAL) and use R Remote to set the IP address.

• SECONDARY PORT

Settings	Switch
DAISY CHAIN	 (4 up)
REDUNDANT	 (4 down)

• START UP MODE

Settings	Switch
<b>REFRESH</b> (The unit starts up with part of the internal memory initialized. Initialization creates the following settings.) <ul style="list-style-type: none"> <li>• HA GAIN (-6 dB)</li> <li>• +48V (OFF)</li> <li>• HPF (OFF)</li> <li>• HPF FREQ (80Hz)</li> <li>• Gain Compensation (OFF)</li> </ul>	 (7 and 8 up)
<b>RESUME</b> (The unit starts up using the settings assigned prior to the most recent power off.)	 (7 down, 8 up)

**NOTE**

If a CL/QL series unit is not connected, we recommend that you set START UP MODE to RESUME. If this is set to REFRESH, settings must be transmitted from R Remote each time the R series unit is restarted.

For RSio64-D

When using R Remote to operate an RSio64-D unit, set the DIP switches and [UNIT ID] rotary switch of the unit, taking note of the following settings.



Set the DIP switches to the following setting.

• SECONDARY PORT

Settings	Switch
DAISY CHAIN	 (4 up)

REDUNDANT	 (4 down)
-----------	--

• START UP MODE

Settings	Switch
NORMAL (Start up normally with the settings of the previous start-up.)	 (7 and 8 up)
INITIALIZE (The unit starts up with the internal memory initialized. Initialization creates the following settings.) <ul style="list-style-type: none"> <li>• SLOT 1-4 SRC (OFF)</li> <li>• WORD CLOCK SELECT (DANTE/48kHz)</li> <li>• USER PATTERN (Same routing configuration as the preset PATTERN # 1)</li> <li>• STATIC IP (Manual) (0.0.0.0)</li> <li>• PANEL LOCK (Unlock)</li> <li>• Dante PATCH (All OFF)</li> <li>• Dante DEVICE LABEL (Y001-Yamaha-RSio64-D-123456 (*1))</li> </ul>	 (7 down, 8 up)



(\*1) The third and fourth characters of the Dante device label depend on device setting DIP switch 1 and the SETUP [UNIT ID] rotary switch. The lower six digits depend on the lower six digits of the unit's MAC address.

For RMio64-D

When using R Remote to operate an RMio64-D unit, set the DIP switches and [UNIT ID] rotary switch of the unit, taking note of the following settings.

Set the DIP switches to the following setting.

• SECONDARY PORT

Settings	Switch
DAISY CHAIN	 (1 up)
REDUNDANT	 (1 down)



## Connect the computer and R series units

Use an Ethernet cable to connect the computer and the R series units.

If you selected DAISY CHAIN in “SECONDARY PORT” on the above, connect the Dante connectors of the R series units in a daisy chain to the computer.

If you selected REDUNDANT in “SECONDARY PORT” on the above, connect the computer to the network switch that is connected to the Dante [PRIMARY] connector.

## Power-on the R series units

Power-on the R series units. If you power-on before making [“Settings on the R series units.”](#) the settings will not be applied.

## Specify the computer's IP address

Specify the computer's IP address so that it can communicate with the R series units.

The method of making this setting depends on whether you're using Windows or Mac. Also, the computer's IP address setting will differ depending on the IP address specified in "[Settings on the R series units.](#)"

If you're using Mac, [click the link.](#)

### For Windows

#### Accessing the Control Panel

The way to access the Control Panel will depend on your operating system.

##### ◆ Windows 7

Select [Start] → [Control Panel].

##### ◆ Windows 8 / Windows 8.1

1. In the Start screen, click [Desktop].  
The desktop will appear.
2. Move the cursor to the upper right or lower right corner of the desktop.  
The Charms bar will appear.
3. Select [Settings] → [Control Panel].

### TCP/IP Settings

Make TCP/IP settings for the computer as follows.

1. Access the Control Panel, then click or double-click [Network and Sharing Center] or [View network status and tasks].  
The "Network and Sharing Center" is displayed.
2. Click [Manage network connection] or [Change adapter settings] from the "Tasks" list located in the left side of "Network and Shearing Center" window, then double-click [Local Area Connection].

The "Local Area Connection Status" dialog box will be displayed.

#### **NOTE**

- The "User Account Control" dialog box may appear. Click [Continue] or [Yes].
- If the "Local Area Connection properties" dialog box appears, skip ahead to step 4.

3. Click [Properties].

The "Local Area Connection properties" dialog box will be displayed.

#### **NOTE**

The "User Account Control" dialog box may appear. Click [Continue] or [Yes].

4. Select [Internet Protocol Version 4(TCP/IPv4)], then click [Properties].

The "Internet Protocol Version 4(TCP/IPv4) Protocol" dialog box will be displayed.

- Make the following settings according to the IP address setting you made in "Settings on the R series units."

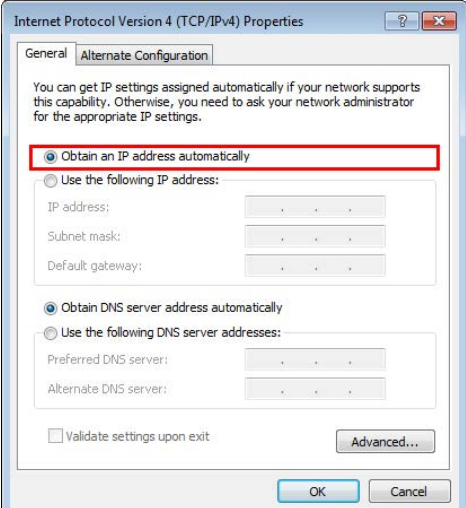
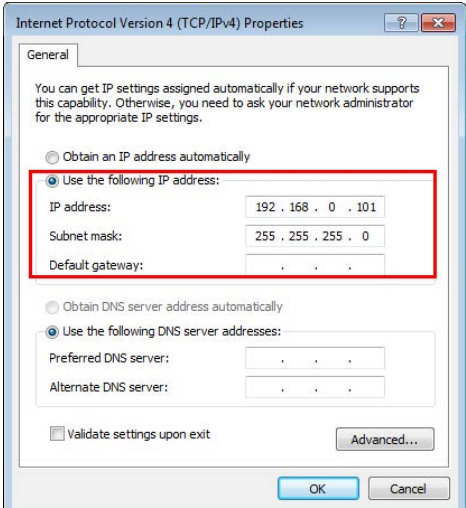
AUTO IP or DHCP	STATIC IP (AUTO)
Click [Obtain an IP address automatically].	Click [Use the following IP address:]. As the IP address, enter "192.168.0.xxx (a value in the range 1 to 254 that does not conflict with any other device, including the R series units), and enter "255.255.255.0" as the subnet mask. The 192.168.0.101 shown below is an example.
	

If you're using STATIC IP (MANUAL), specify the setting that's appropriate for your network. For details, consult your network administrator.

- Click [OK].

Proceed to ["Use Dante Controller or the CL/QL series console to specify the routing."](#)

## For Mac

Make TCP/IP settings for the computer as follows.

1. Click [System Preferences]→[Network].  
The “Network” dialog box will be displayed.
2. Click the service that you want to connect to the R series unit.  
If you're using the Ethernet port that's built into the Mac, click [Ethernet].
3. Make the following settings according to the IP address setting you made in ["Settings on the R series units."](#)

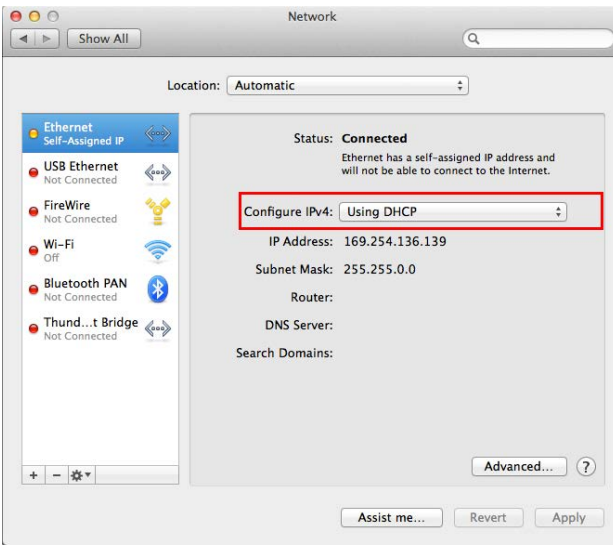
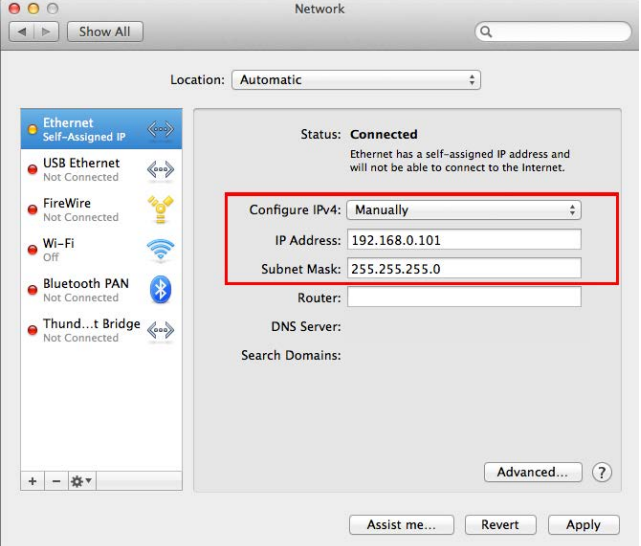
AUTO IP or DHCP	STATIC IP (AUTO)
In "Configure IPv4," choose [Using DHCP].	In “Configure IPv4,” choose [Manually]. As the IP address, enter "192.168.0.xxx (a value in the range 1 to 254 that does not conflict with any other device, including the R series units), and enter "255.255.255.0" as the subnet mask. The 192.168.0.101 shown below is an example.
 A screenshot of the Mac Network settings window for Ethernet. The 'Configure IPv4' dropdown menu is highlighted with a red box and set to 'Using DHCP'. The IP Address is 169.254.136.139 and the Subnet Mask is 255.255.0.0.	 A screenshot of the Mac Network settings window for Ethernet. The 'Configure IPv4' dropdown menu is highlighted with a red box and set to 'Manually'. The IP Address is 192.168.0.101 and the Subnet Mask is 255.255.255.0.

If you're using STATIC IP (MANUAL), specify the setting that's appropriate for your network. For details, consult your network administrator.

4. Click [Apply] button, then close “Network” dialog box.

## Use Dante Controller or the CL/QL series console to specify the routing

You'll use Dante Controller or the CL/QL series console to specify the routing.

If you're using Dante Controller to specify the routing, refer to "Dante Controller User's Guide."

If you're using a CL/QL series console to specify the routing, refer to the each Reference Manual.

This completes the setup.

## ■ Operating R Remote

Start R Remote.

Windows 7 users: click [Start]→[All Programs]→[Yamaha R Remote]→[R Remote]

Windows 8/8.1 users: in the "Start screen," double-click the [R Remote] tile.

Mac users: click [Go]→[Applications]→ double-click [R Remote].

### **NOTE**

- When you start R Remote, the ["Network Setup" dialog box](#) may appear, allowing you to select the computer's network card that will be used for communication with the R series units. If this appears, click the network card that is connected to the R series unit, and then click the [Apply] button.
- For R Remote for Windows 8 / Windows 8.1, depending upon user access privileges, the software's "Tile(icon)" may not appear on the "Start screen". In such cases, you can find the software icon in "Apps" by the following steps:
  1. Right-click anywhere on Start screen.
  2. Click "All apps" button at the bottom right side of Start screen.

## Menu bar

The commands that can be executed by R Remote can be found here, grouped by category.

Click here to see a list of commands.



Menu	Command	Summary	Dialog box that appears
[File]	[Open]	Opens a previously-saved file (rrmt format or rrm format). <b>NOTE</b> If you open the file when R series units are connected, the settings will be applied to the R series units. Be aware that if a CL/QL series console is also connected, its settings will be overwritten.	"Open File" dialog box
	[Save As]	Saves the file. It will have a file name extension of rrmt, and will be usable only by R Remote.	"Save File" dialog box
	[Network Setup]	Selects the computer's network adapter that will be used to communicate with the R series.	<a href="#">"Network Setup" dialog box</a>
	[Device Information]	Displays information about the R series units that are connected.	<a href="#">"Device Information" dialog box</a>
	[Quit]	Quits R Remote.	---
[About] *1	[About R Remote]	Displays details such as the software version of R Remote.	"About R Remote" dialog box

\*1 Mac users: [About] is located in the R Remote menu.

## Areas of the screen

The R Remote screen is broadly divided into three areas: the Device Selection Area, the Information Display Area, and the Main Area.



## Device Selection Area



When you click a display switching button, the corresponding R series unit is shown in the information display area and in the main area.

With a display switching button selected, pressing the left button makes all indicators of the corresponding R series unit blink, allowing you to identify the corresponding unit.

When you right-click a display switching button, the following context menu appears.

Command	Summary
[Mount]	Opens the "Mount" window. Select the device that you want to mount.
[Connect]	Synchronizes with the selected device.
[Disconnect]	Disconnects from the selected device.
[Properties]	Open the <a href="#">"Properties" dialog box</a> .

The connection status is shown below each display switching button.

Indication	Status
VIRTUAL	The device is mounted without the existence of the actual device.
CONNECTING	Currently synchronizing with the device.
CONNECTED	Currently synchronized with the device.
DISCONNECTED	Synchronization with the device is possible, but is currently disconnected by the [Disconnect] command. Alternatively, communication has been interrupted, or connection failed.
DUPLICATED	More than one device of the same UNIT ID exists. Eliminate any UNIT ID conflict between devices.

### **NOTE**

The VIRTUAL indication is also shown if the device is in any of the following states.

- Device is not powered-on.
- Not connected to the computer.
- Communication is impossible due to incorrect settings.

## Information Display Area

This area shows the UNIT ID and name of the selected device.

To check the firmware version or IP address, choose [File] menu -> [Device Information] to open the ["Device Information" dialog box](#).



## Main Area

This area shows the state of the selected R series unit and allows basic parameter editing. The display depends on the model.

For Rio3224-D / Rio1608-D / Ri8-D

The screen is explained here using the Rio3224-D as an example. The number of items in the HA display area differs depending on the model.

The [Edit window](#) opens if you double-click or right-click and choose [Open Edit Window] anywhere other than on a controller.

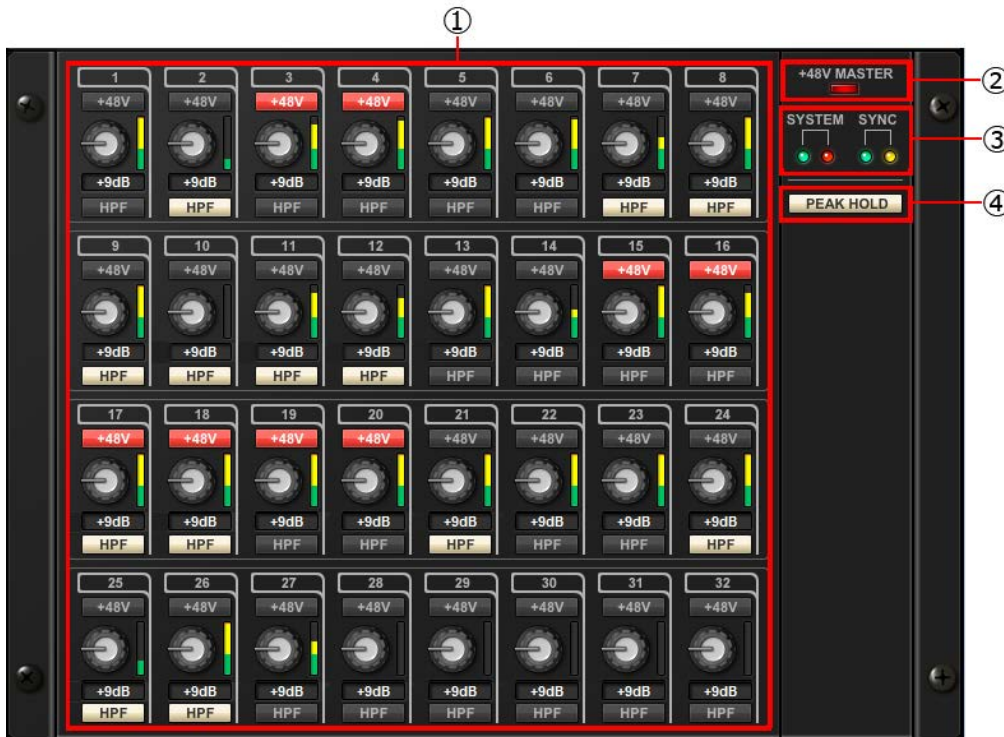

### ① HA display area

Here you can view and edit HA settings for the Rio3224-D / Rio1608-D / Ri8-D unit.

If you press the left mouse button on an area that shows the device's jack number, the indicator of the actual device's corresponding jack will light.



### ① [ +48V ] button

Turns phantom power on/off for each channel.

### ② GAIN knob

Specifies the analog gain for the HA of the device. The current setting is shown in the numeric box located below the knob.



You can double-click a numeric value box and enter a value directly from the keyboard. The level meter located at the immediate right of the knob indicates the input level of the corresponding port.

On the knobs, you can use the following shortcuts and context menu.

Action	Operation				
<Ctrl> (<command>) + click	Sets analog gain to the default value (-6 dB).				
<Ctrl> (<command>) + <Shift> + click	Sets the analog gain to 0 dB.				
Right click	Displays the following context menu. <table border="1" data-bbox="758 571 1428 810"> <tbody> <tr> <td>[All Default]</td> <td>Sets the analog gain of all channels to the default value (-6 dB).</td> </tr> <tr> <td>[All 0dB]</td> <td>Sets the analog gain of all channels to 0 dB.</td> </tr> </tbody> </table>	[All Default]	Sets the analog gain of all channels to the default value (-6 dB).	[All 0dB]	Sets the analog gain of all channels to 0 dB.
[All Default]	Sets the analog gain of all channels to the default value (-6 dB).				
[All 0dB]	Sets the analog gain of all channels to 0 dB.				

③ [HPF] button

This is an on/off switch for the high-pass filter that is built into the HA of the device. To specify the cutoff frequency, make settings in the [Edit window](#).

② [+48V MASTER] indicator

Indicates the master phantom power on/off status for the device (the on/off setting is switched on the device itself).

③ [SYSTEM] indicator / [SYNC] indicator

Indicates the status of the device or the Dante status. When you move the mouse cursor to this area, the display content appears as a popup.

④ [PEAK HOLD] button

If this button is on, the peaks of each level meter are held. When you turn this off, the peaks that had been held are cancelled.

## Edit window

This appears if you double-click in the main area other than on a controller, or if you right-click and choose [Open Edit Window].

Here you can view and edit detailed HA settings for the device. To close the window, click the [x] button in the upper right if you're using Windows, or click the [x] button if you're using Mac.

The screen is explained here using the Rio3224-D as an example. The number of channel switching tabs differs depending on the model.



- ① Device name  
Shows the UNIT ID number and name of the device.
- ② [PEAK HOLD] button  
If this button is on, the peaks of each level meter are held. When you turn this off, the peaks that had been held are cancelled.
- ③ Port select tab  
For the Rio3224-D or Rio1608-D, these tabs switch the ports that are shown.
- ④ Port index  
Indicates the port number of the device. When you press this with the left mouse button, the indicator of the corresponding port of the device will light.
- ⑤ [+48V] button  
Turns the HA phantom power on/off.

⑥ [A.GAIN] knob

Specifies the analog gain for the HA of the device. The current setting is shown in the numeric box located below the knob.

You can double-click a numeric value box and enter a value directly from the keyboard.

The level meter located at the immediate right of the knob indicates the input level of the corresponding port.

On the knobs, you can use the following shortcuts and context menu.

Action	Operation				
<Ctrl> (<command>) + click	Sets analog gain to the default value (-6 dB).				
<Ctrl> (<command>) + <Shift> + click	Sets analog gain to 0 dB.				
Right click	Displays the following context menu. <table border="1" data-bbox="756 712 1430 954"> <tbody> <tr> <td>[All Default]</td> <td>Sets the analog gain of all channels to the default value (-6 dB).</td> </tr> <tr> <td>[All 0dB]</td> <td>Sets the analog gain of all channels to 0 dB.</td> </tr> </tbody> </table>	[All Default]	Sets the analog gain of all channels to the default value (-6 dB).	[All 0dB]	Sets the analog gain of all channels to 0 dB.
[All Default]	Sets the analog gain of all channels to the default value (-6 dB).				
[All 0dB]	Sets the analog gain of all channels to 0 dB.				

⑦ [GC] button

Switches on/off the gain compensation that regularizes the signal level on the audio network. If this is on, the gain value fixed by gain compensation is displayed, and subsequent changes to analog gain is compensated by the compensation gain within the device; audio is transmitted to the Dante network at the gain value that was fixed immediately before this was enabled.

**NOTE**

There are limits to the amount of gain compensation. The maximum compensation is 24 dB when turning the knob toward the left, and 48 dB when turning the knob toward the right. For example if you apply gain compensation at 30 dB, compensation is maintained until you set the analog gain to 6 dB, but if you set the analog gain to 4 dB, the gain value that is output will be 28 dB. If in this state you return the setting to 6 dB or higher, compensation maintains the level at 30 dB.

⑧ [FREQ] knob / [HPF] button

Switches on/off the high-pass filter that is built into the HA of the device, and adjusts the cutoff frequency. The current setting is shown in the numeric box located below the knob.

If you <ctrl> (<command>) + click above the [FREQ] knob, the cutoff frequency is set to the default value (80 Hz).

For Ro8-D

The Ro8-D has no settings that can be operated, so only the [SYSTEM] indicator and [SYNC] indicator are shown.

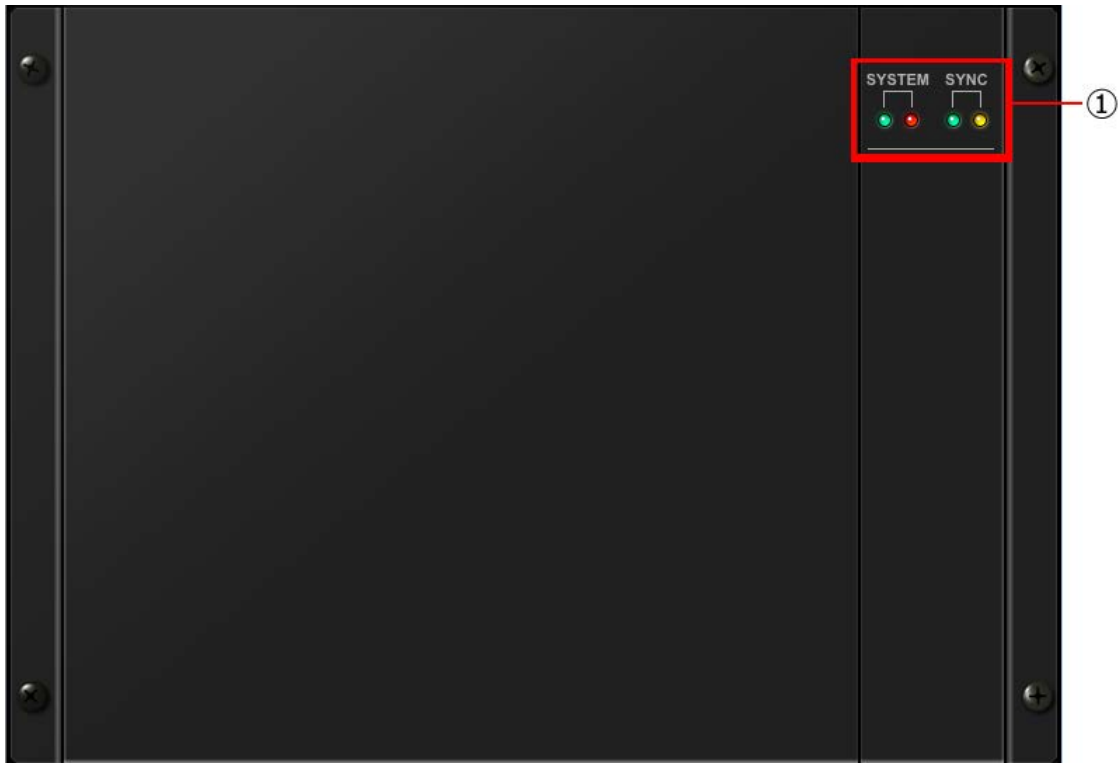

① [SYSTEM] indicator / [SYNC] indicator

Indicates the status of the device or the Dante status. When you move the mouse cursor to this area, the display content appears as a popup.

For RSio64-D

You can change the RSio64-D settings.

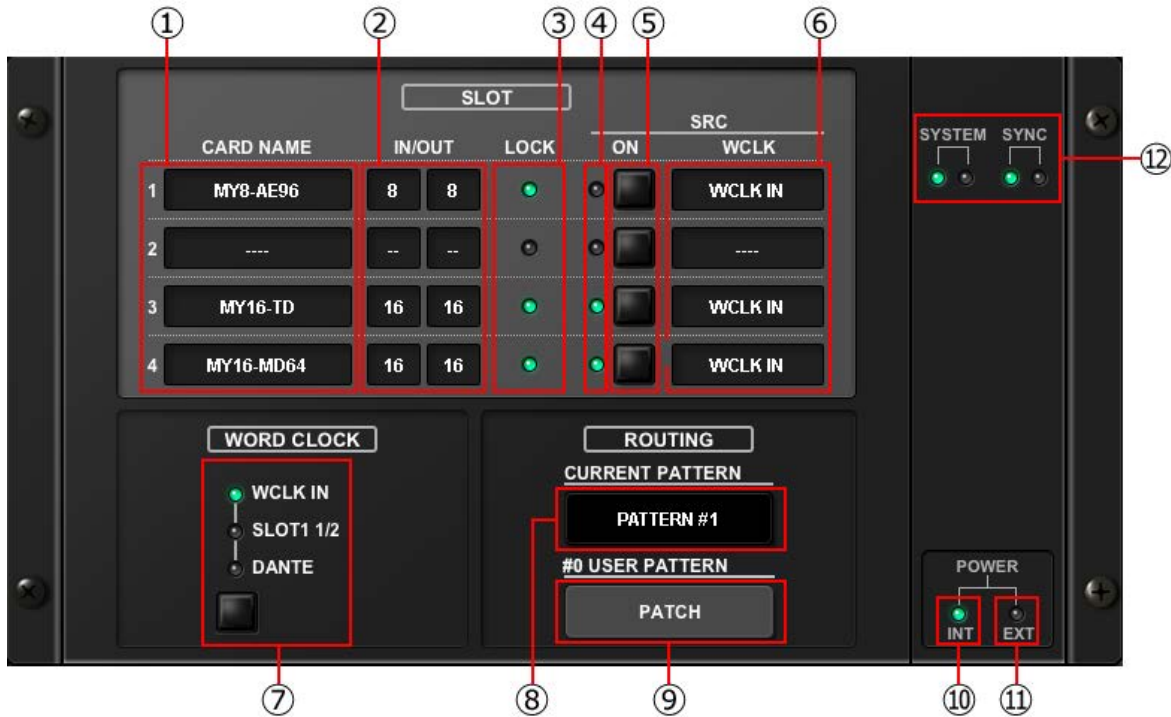

① CARD NAME

This indicates the names of the cards installed in slots 1 to 4. If nothing is installed, “----” will appear.

② IN/OUT PORT

This indicates the number of input and output ports for the cards installed in slots 1 to 4. If no card is installed, “--” will appear.

③ SLOT1~4 [LOCK] indicators

This indicates the word clock status for slots 1 to 4. If the word clock is operating normally, this indicator will be green.

Off	There is no card in the slot. Or, an unsupported card is in the slot.
Green (On) LOCK	Indicates that a clock synchronized with the clock source selected with the [WORD CLOCK] select key is being input from the card. If an external device is connected to the corresponding slot, input/output is occurring properly between that device and the RSio64-D. If the sampling frequency is close, this status may be displayed even if not synchronized.
Green (Flashing) SYNC ERROR	A valid clock is being input from the card, but is not synchronized with the clock source selected with the [WORD CLOCK] select key. If an external device is connected to the corresponding slot, input/output cannot occur correctly between that device and the RSio64-D. Turn SRC ON for correct input/output.

Red (On) UNLOCK	A valid clock is not being input from the card. If an external device is connected to the corresponding slot, input/output cannot occur correctly between that device and the RSio64-D.
Red (Flashing) WRONG WORD CLOCK	The frequency of the clock source selected with the [WORD CLOCK] select key is outside of the operating frequency range for the card inserted in the slot. Either set the frequency of the clock source within the operating range for the card, or turn [SRC] ON. For an analog card, if you turn [SRC] ON, the frequency is set to the 48kHz built into the RSio64-D.

④ SLOT1~4 [SRC] indicators

Indicate the Sampling Rate Converter (SRC) status for slots 1 to 4.

Off	SRC is off.
Green (On)	SRC is on, and the clock selected with the SRC WCLK DIP switches on the RSio64-D is being input correctly.
Red (On)	SRC is on, but an appropriate clock is not being input. The clock selected with the SRC WCLK DIP switches on the RSio64-D is either not being input or is not within the operating range. Either turn SRC off, or change the DIP switch settings.

**NOTE**

Use the SRC WCLK DIP switches on the RSio64-D to set the SRC clock sent to the Mini-YGDAI card inserted in the slot.

⑤ SLOT1~4 [SRC] buttons

Used to turn SRC on/off at both IN and OUT for each slot.

⑥ WORD CLOCK source

Indicates the SRC word clock source status for slots 1 to 4 the RSio64-D.

SLOT	When using the word clock signal being input from the card in the slot.
WCLK IN	When using the word clock signal being input from the WORD CLOCK IN connector on the rear panel.
----	If there is no card in the slot.

⑦ WORD CLOCK select button

Used to select the word clock source for the RSio64-D.

- WORD CLOCK WCLK IN indicator
- WORD CLOCK SLOT1 1/2 indicator
- WORD CLOCK DANTE indicator

Indicates the word clock source status for the RSio64-D.

WCLK IN	On when using the word clock signal being input from the WORD CLOCK IN connector on the rear panel of the RSio64-D. Flashes*1 if there is no valid word clock input.
------------	--

SLOT1 1/2	On when using the word clock for channels 1/2 of slot 1 for the RSio64-D. Flashes*1 if there is no valid word clock input. When using MY8-AEB*2, the word clock for channels 7/8 is used.
DANTE	On when using the word clock for the Dante network*3. (If there is no valid Dante signal input, the internal Dante module will generate a clock.)

\*1 When flashing, Dante word clock\*3 input/output is used.

\*2 If you are using MY8-AEB, set the AE⇔RSVD switch for the card to RSVD.

\*3 If you make changes to the frequency of the Dante word clock, use Dante Controller.

⑧ [CURRENT PATTERN] button

If you press this button, the currently selected routing pattern on the RSio64-D is displayed. If you switch the routing pattern on the RSio64-D, it will be applied in 3 seconds.

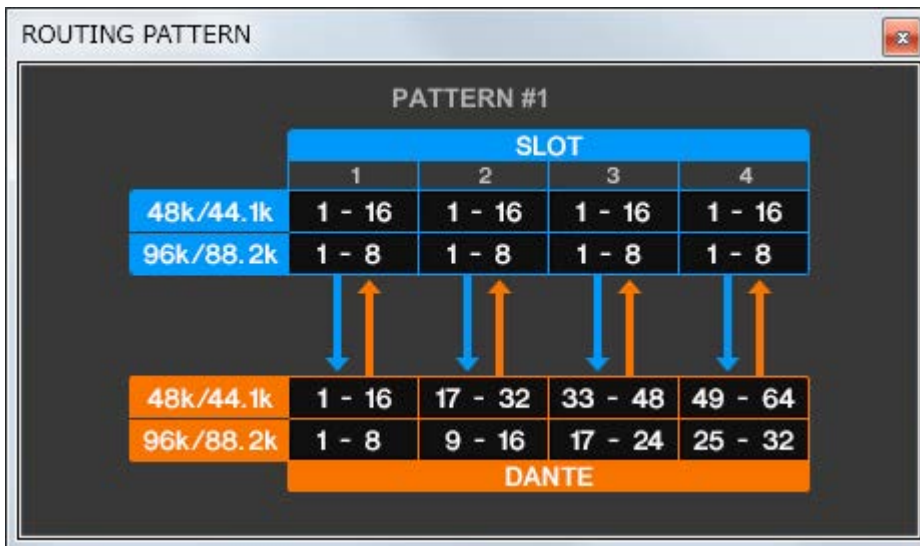

⑨ [USER PATTERN] button

Press this button to open the window for setting the audio routing user pattern in the RSio64-D.

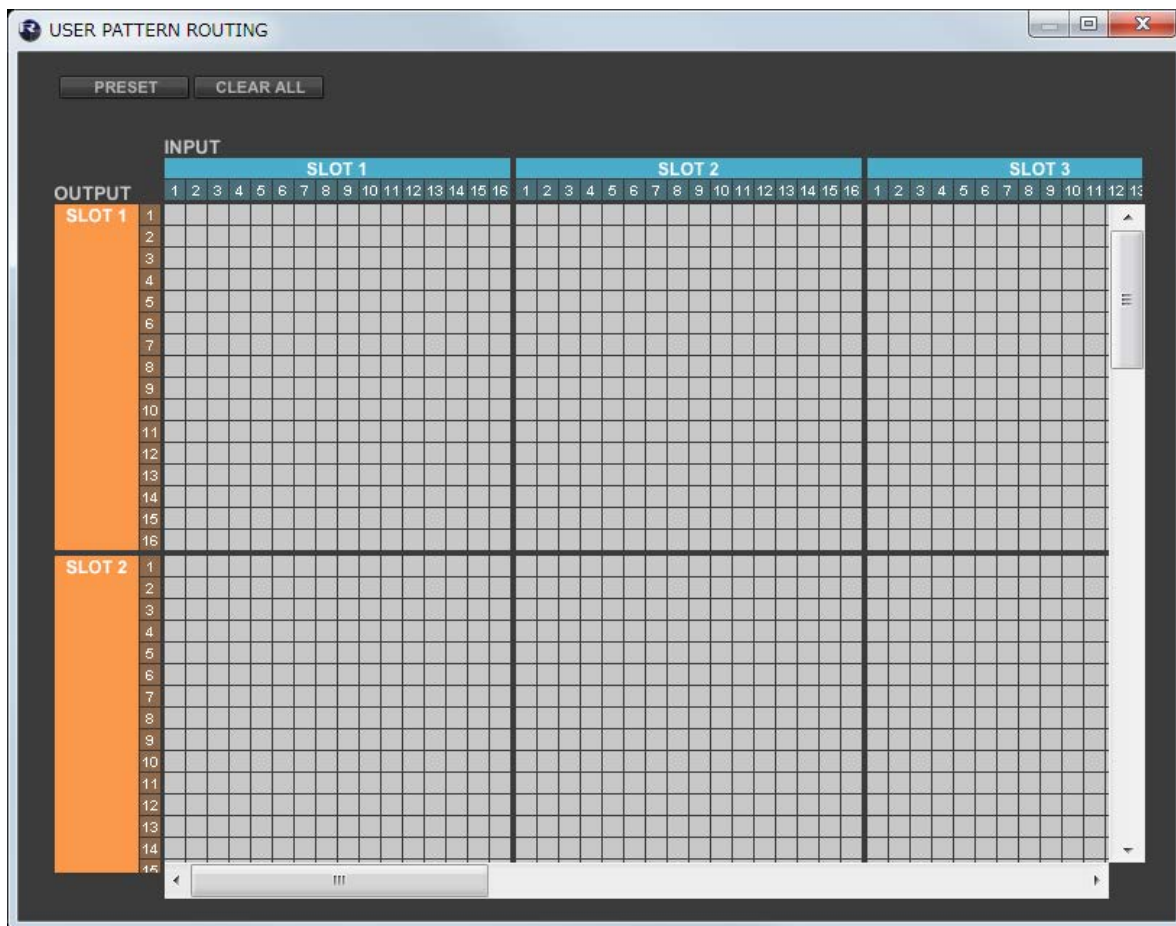

- **PRESET** button 

As a template for editing the patch, you can call by selecting from preset patterns 1-7.
- **CLEAR ALL** button 

Clear all patches.

⑩ POWER INT indicator

Indicates the status of the AC IN power supply for the RSio64-D. If the power switch is off, no power is supplied to AC IN and the indicator remains off.

⑪ POWER EXT indicator

Indicates the status of the EXT DC INPUT power supply for the RSio64-D. If the power supply is on, this indicator will be on. This indicator is not affected by the status of the power switch.

⑫ [SYSTEM] indicator/[SYNC] indicator

Indicates the status of the device or the Dante status. When you move the mouse cursor to this area, the display content appears as a popup.



For RMio64-D

You can change the RSio64-D settings.

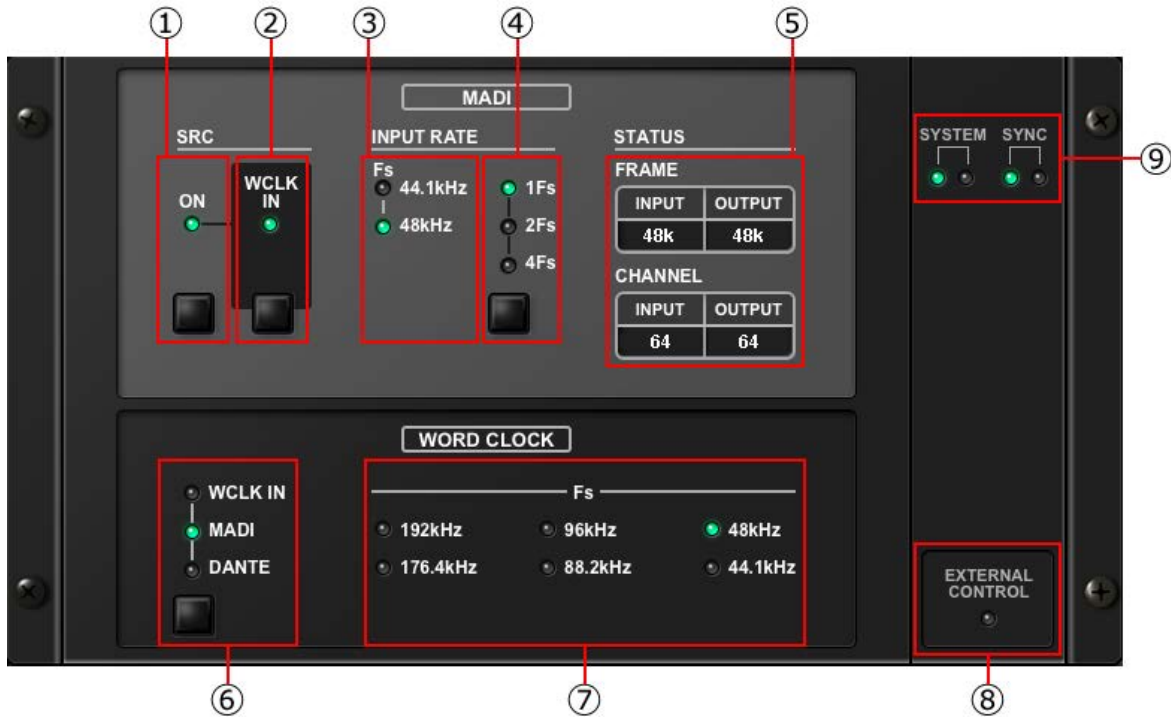

- ① MADI [SRC ON] indicator  
MADI [SRC ON] button  
Switches the SRC (Sampling Rate Converter) on and off.
  
- ② MADI [SRC WCLK IN] indicator  
MADI [SRC WCLK IN] button  
Use this button to select whether to use (indicator on) or not use (indicator off) the word clock input from the MADI WCLK IN FOR SRC jack on the rear panel of the RMio64-D as a standard clock for SRC.
  
- ③ MADI [INPUT RATE Fs 44.1kHz] indicator  
MADI [INPUT RATE Fs 48kHz] indicator  
Automatically detect and indicate whether the MADI input signal is 44.1 kHz or 48 kHz. Both indicators remain off if there is no valid MADI input signal.
  
- ④ MADI [INPUT RATE 1Fs] indicator  
MADI [INPUT RATE 2Fs] indicator  
MADI [INPUT RATE 4Fs] indicator  
MADI [INPUT RATE] 1Fs/2Fs/4Fs button  
Select either 1Fs (1x), 2Fs (2x), or 4Fs (4x), based on the MADI input frequency. For example, if the MADI input signal is 192 kHz (4x 48 kHz), confirm that the MADI INPUT RATE Fs 48kHz

indicator is on and then select “4Fs”.

**NOTE**

When “2Fs” is selected, the unit automatically detects the frame frequency (48 kHz/96 kHz) of the MADI input signal.

- ⑤ MADI [STATUS INPUT] status  
MADI [STATUS OUTPUT] status  
Display information regarding the MADI input and output signals (frame frequency/number of channels).

- ⑥ WORD CLOCK [WCLK IN] indicator  
WORD CLOCK [MADI] indicator  
WORD CLOCK [DANTE] indicator  
WORD CLOCK [WCLK IN/MADI/DANTE] buttons  
Used to select the word clock source.

WCLK IN	Uses the word clock signal being input from the WORD CLOCK IN connector on the rear panel of RMio64-D. The indicators flash when there is no valid word clock input.
MADI	Uses the word clock of the MADI input signal. The indicators flash when there is no valid word clock input.
DANTE	Uses the word clock of the Dante network.

- ⑦ WORD CLOCK [Fs] indicator  
Indicates the word clock frequency at which the unit is operating. Flashes when not synchronized.
- ⑧ [EXTERNAL CONTROL] indicator  
This indicator comes on when there is a valid parameter that can be operated only externally by remote control.  
Refer to “Remote Control” in the RMio64-D Owner's Manual for details about parameters that can be operated by remote control.
- ⑨ [SYSTEM] indicator /[SYNC] indicator  
Indicates the status of the device or the Dante status. When you move the mouse cursor to this area, the display content appears as a popup.

## “Network Setup” dialog box

This appears when you choose [File] menu -> [Network Setup].

Here you can select the network interface card of the computer that will be used to communicate with the R series (subsequently called “the network card”).

### NOTICE

The various settings are initialized if you change network cards. In order to use the current settings, please save the settings to a file and change the network card.

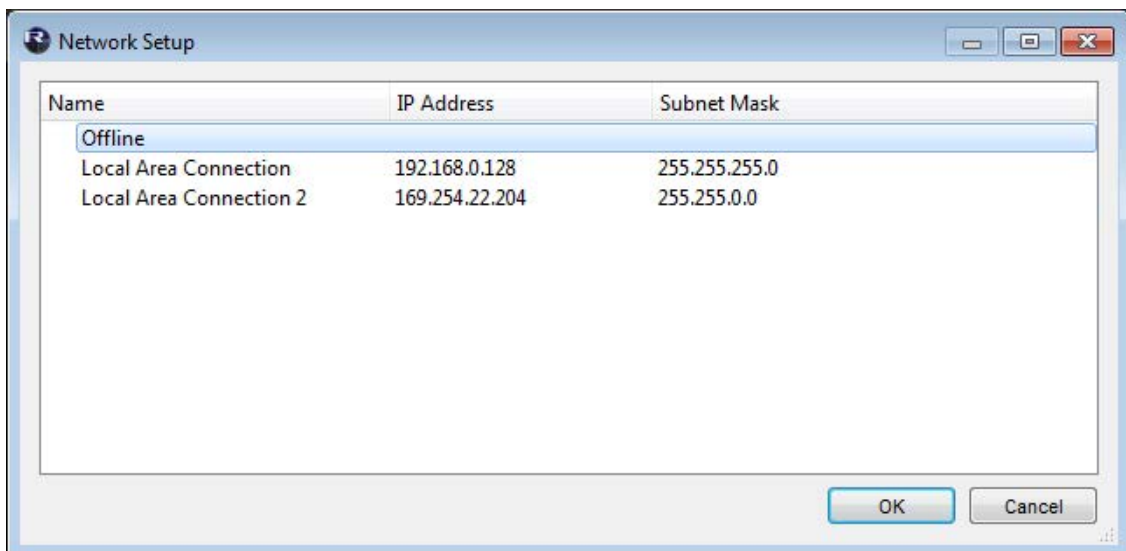

#### ① Network card list

Select the network card that will be used to communicate with R series. When you double-click a network card, the network card you double-clicked is selected and the dialog box closes.

If you only want to make settings without connecting an R series unit, select [Offline]. If you select a network card, a load is placed on the connected network.

#### ② [OK] button

Update the settings and closes the dialog box.

#### ③ [Cancel] button

Close the dialog box without updating the settings.

## “Device Information” dialog box

This appears when you choose [File] menu -> [Device Information].

This lists information about the R series devices that are connected.

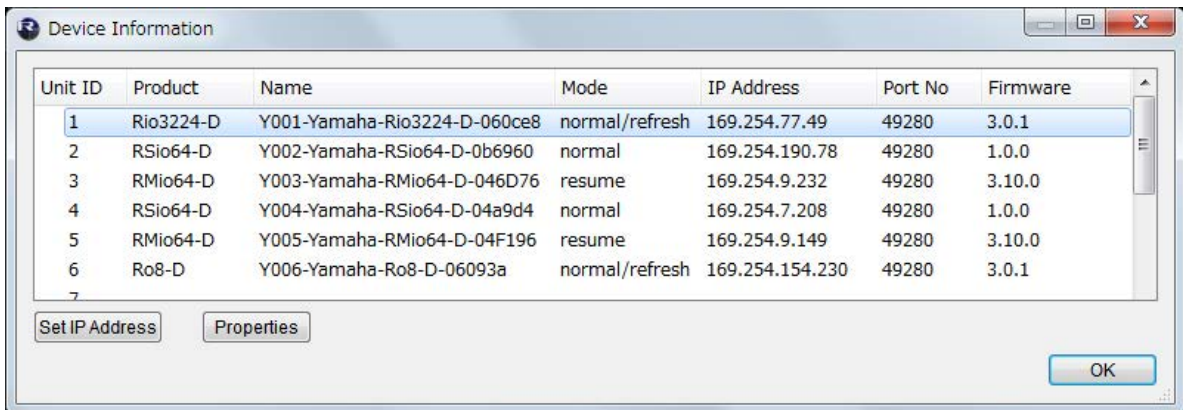

### ① Device list

By right-clicking the name of an item such as Unit ID, you can select the items that are shown.

- Unit ID  
Shows the UNIT ID of the device.
- Product  
Shows the model name of the device.
- Name  
Shows the device name. This name can be edited in Dante Controller.
- Mode  
Shows the START UP MODE of the device.
- IP Address  
Shows the IP address that is specified for the device.
- Port No.  
Shows the communication port number of the device.
- Firmware  
Shows the main firmware version of the device.

### ② [Set IP Address] button

When you click this button, the [“IP Address” dialog box](#) will appear (excluding RMio64-D).

### ③ [Properties] button

When you click this button, the [“Properties” dialog box](#) will appear.

### ④ [OK] button

Closes the dialog box.

## “IP Address” dialog box

This appears when you click the [Set IP Address] button in the "Device Information" dialog box.

Here you can view the device's IP SELECT MODE status, or specify the IP address for a STATIC IP (MANUAL) device.

### **NOTE**

RMio64-D does not have the IP Address setting function. Since it is automatically set by the AUTO IP, [Set IP Address] button will be disabled.

If you want to use an R series device (excluding RMio64-D) in STATIC IP (MANUAL) mode, perform the following steps.

1. Start up the R series device in a mode other than STATIC IP (MANUAL).
2. Start R Remote.
3. In the "Device Information" dialog box, select the device that you will be setting to STATIC IP (MANUAL).
4. In the "IP Address" dialog box, enter the necessary information for Static IP (Manual).
5. Click the [OK] button.
6. Put the R series device in STATIC IP (MANUAL) mode, and restart.

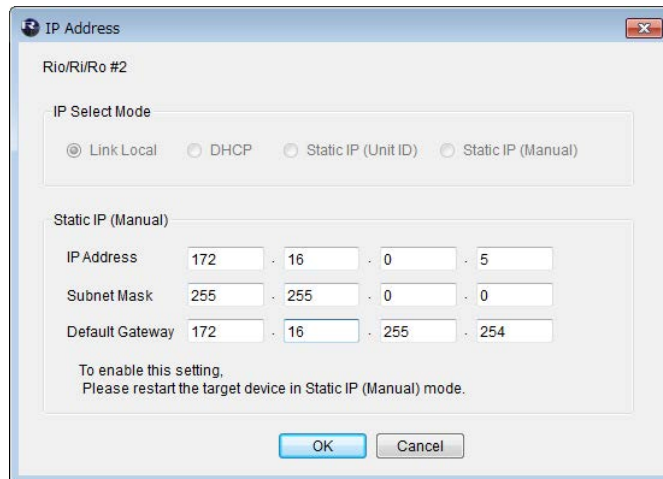

- ① IP Select Mode  
Shows the IP SELECT MODE of the device.
- ② Static IP (Manual)  
Specifies the IP address etc. that is used when the device starts with its IP SELECT MODE set to STATIC IP (MANUAL).
- ③ [OK] button  
Saves the settings and closes the dialog box.  
If you want to change to the IP address that is specified here, set the device's DIP switch to STATIC IP (MANUAL), and then restart the device.
- ④ [Cancel] button  
Discards changes and closes the dialog box.

## “Properties” dialog box

This dialog box appears when you click the [Properties] button in the "Device Information" dialog box.

This displays information about the device that are connected.

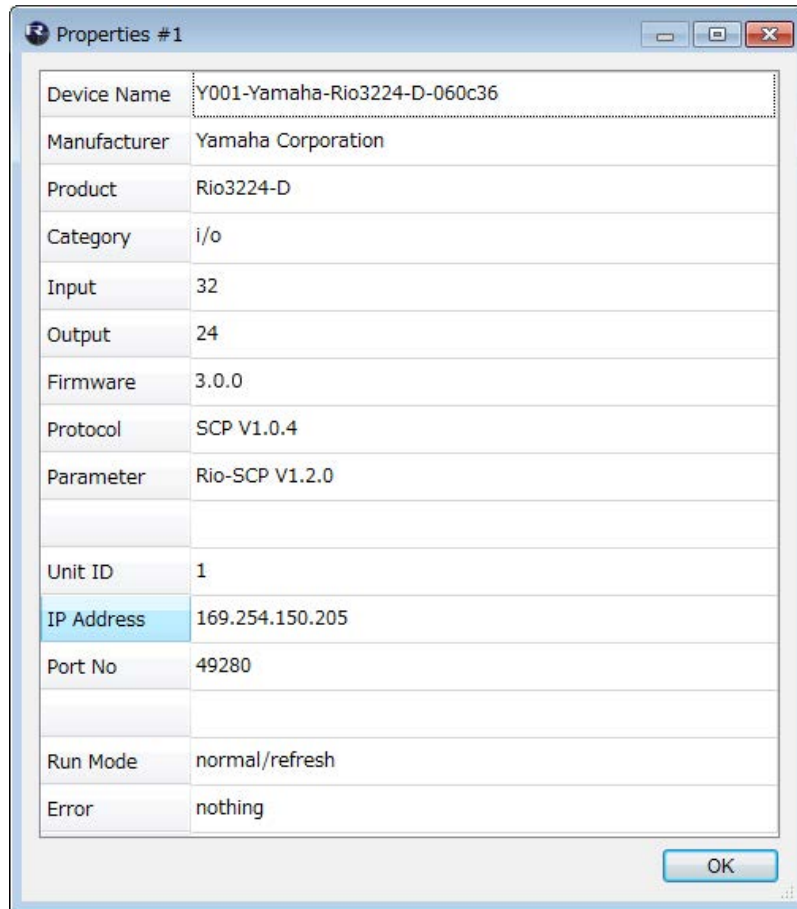

① [Information] display area

Shows information about the device. If the device is not connected, no information is shown.

② [OK] button

Close the window.

## ■ Uninstalling the software(Removing the application)

Windows:

Use [“Control Panel”](#) to uninstall the software.

In Control Panel, click [Programs and functions] or [Uninstall a program], then select the item you want to uninstall, and click [Uninstall or change].

A dialog box will appear; follow the instructions in the screen to uninstall the software.

If the “User Account Control” dialog box appears, click [Continue] or [Yes].

Mac:

Double-click "Uninstall R Remote.app" which is included in the installer.

## ■ Troubleshooting

Problem	Possible cause	Action
R series unit is not connected.	The R series unit's power switch is not on.	Turn the power switch on.
	The R series unit's DIP switch settings are incorrect.	Refer to " <a href="#">Settings on the R series units.</a> " and make the appropriate settings.
	The UNIT ID of the R series unit is set to something other than 1 through 24.	Specify a UNIT ID in the range from decimal 1 to 24 (hexadecimal 1 to 18). For more about these numbers, refer to " <a href="#">Decimal/hexadecimal conversion table.</a> "
	The cables are not connected properly.	If the orange [SYNC] indicator is blinking, the cable is either broken or not connected correctly. Connect the cable correctly.
		If you're using REDUNDANT mode, connect to the network switch that is connected to the [PRIMARY] connector.
	The computer's IP address setting is incorrect.	Set the computer's IP address to match the R series unit's DIP switch setting.
	Network card selection is incorrect.	In the " <a href="#">Network Setup</a> " dialog box, select the network card that communicates with the R series unit.
	Firmware is old.	Use V3.00 or later firmware.
The R series unit is in AD8HR mode.	Set DIP switches 5 and 6 in the upward position to select NATIVE mode.	
Audio is not input / Input level is low.	HA gain is not at an appropriate level.	Set the <a href="#">HA gain</a> to an appropriate level.



	The external device is not outputting a signal	Output a signal from the source device and make sure that the SIG indicators on the appropriate channels will light.
	Phantom power is not being supplied even though a condenser microphone is connected.	Turn the [+48V MASTER] switch on. <a href="#">Turn phantom power on for the corresponding channel.</a>
	REFRESH mode is selected with the CL/QL series not connected.	Select RESUME mode.
Adjusting the HA gain does not change the audio level.	Gain compensation is on.	If you don't need gain compensation, <a href="#">turn gain compensation off.</a>
[UNIT ID] rotary switch and DIP switch settings are not applied.	The settings were changed while the power was on.	Turn off the power before changing the settings.
The R series unit is not recognized.	Communication is blocked by the Windows firewall.	Perform the following procedure so that R Remote is not blocked by the Windows firewall. <ol style="list-style-type: none"> <li>1. Open <a href="#">Control Panel</a>.</li> <li>2. In the upper right, set "View by" to [Category].</li> <li>3. Click [System and Security].</li> <li>4. Click [Allow an app through Windows Firewall].</li> <li>5. In "Allowed apps and features," select the checkbox for "Yamaha R Remote" and also select the checkbox at the right.</li> <li>6. Click the [OK] button to close Control Panel.</li> </ol>
The R series unit is unexpectedly disconnected.	(Mac)App Nap is not disabled.	<a href="#">Select the [Prevent App Nap] checkbox.</a>
	The computer has entered sleep mode.	Set the computer so that it does not enter sleep mode.

## Decimal/hexadecimal conversion table

R Remote only uses values in the range of decimal 1 to 24.

Decimal	Hexa- decimal
1	1
2	2
3	3
4	4
5	5
6	6
7	7
8	8
9	9
10	A
11	B
12	C

Decimal	Hexa- decimal
13	D
14	E
15	F
16	10
17	11
18	12
19	13
20	14
21	15
22	16
23	17
24	18

Decimal	Hexa- decimal
25	19
26	1A
27	1B
28	1C
29	1D
30	1E
31	1F
32	20
33	21
34	22
35	23
36	24

Decimal	Hexa- decimal
37	25
38	26
39	27
40	28
41	29
42	2A
43	2B
44	2C
45	2D
46	2E
47	2F
48	30